

# Panasonic®

## Operating Instructions Functional Manual

FULL HD LCD Display For business use

---

Model No. **TH-55VF1HU** 55-inch model

**TH-55VF1HW** 55-inch model

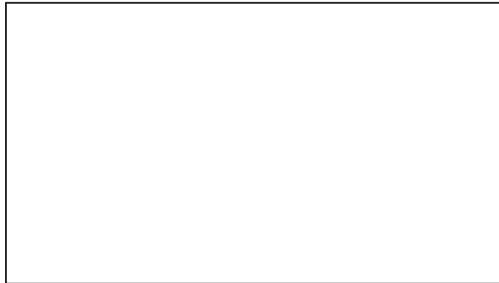

\* This manual is common to all the models regardless of suffixes of the model number.

U : for US, Canada and Mexico

W : for EU, CIS, South East Asia and Middle East Asia

English

Please read these instructions before operating your set and retain them for future reference.



### HDMI

DPQP1100ZB

## Dear Panasonic Customer

Welcome to the Panasonic family of customers. We hope that you will have many years of enjoyment from your new LCD Display.

To obtain maximum benefit from your set, please read these Instructions before making any adjustments, and retain them for future reference.

Retain your purchase receipt also, and note down the model number and serial number of your set in the space provided on the rear cover of these instructions.

Visit our Panasonic Web Site

<https://panasonic.net/cns/prodisplays/>

## Table of Contents

### Before use

- Illustrations and screens in this Operating Instructions are images for illustration purposes, and may be different from the actual ones.

<b>Important Safety Instructions</b> .....	<b>4</b>
<b>FCC STATEMENT</b> .....	<b>5</b>
<b>Important Safety Notice</b> .....	<b>6</b>
<b>Safety Precautions</b> .....	<b>7</b>
<b>Precautions for use</b> .....	<b>10</b>
<b>Accessories</b> .....	<b>12</b>
Accessories Supply .....	12
Remote Control Batteries .....	13
<b>VESA Mounting</b> .....	<b>13</b>
<b>Cautions when installing multi displays</b> .....	<b>14</b>
<b>Cautions when moving</b> .....	<b>15</b>
<b>LCD panel protection</b> .....	<b>15</b>
<b>Eyebolt</b> .....	<b>16</b>
<b>Kensington security</b> .....	<b>16</b>
<b>Connections</b> .....	<b>17</b>
AC cord connection and fixing .....	17
Cable fixing .....	17
Video equipment connection .....	18
Before connecting .....	19
HDMI terminal connection .....	20
DisplayPort terminal connection .....	21
DVI-D IN 1 / DVI-D IN 2 terminal connection .....	22
PC IN terminal connection .....	23
DIGITAL LINK IN / OUT terminal connection .....	24
VIDEO IN terminal connection .....	25
COMPONENT/RGB IN terminal connection .....	26
SERIAL terminal connection .....	26
IR IN/IR OUT terminal connection .....	29
AUDIO OUT terminal connection .....	29
USB terminal connection .....	30
Speaker terminal connection .....	30
<b>Identifying Controls</b> .....	<b>31</b>
Main Unit .....	31
Remote Control Transmitter .....	32

<b>Basic Controls</b> .....	<b>33</b>	Example of network connection .....	84
Selecting the input signal .....	35	Command control .....	86
RECALL .....	36	Control Command via LAN .....	86
Volume Adjustment .....	36	PJLink protocol .....	90
Sound mute On / Off .....	36	Early Warning Software .....	91
OFF TIMER .....	37	Multi Monitoring & Control Software .....	91
<b>ASPECT Controls</b> .....	<b>38</b>	Video Wall Manager .....	91
<b>Digital ZOOM</b> .....	<b>39</b>	<b>Connecting with LAN</b> .....	<b>92</b>
<b>On-Screen Menu Displays</b> .....	<b>40</b>	Computer operation .....	92
<b>Adjusting Position</b> .....	<b>42</b>	<b>Using Web Browser Control</b> .....	<b>92</b>
Auto setup .....	42	Before Using Web Browser Control .....	92
<b>Sound Adjustment</b> .....	<b>44</b>	Access from Web Browser .....	93
<b>Picture Adjustments</b> .....	<b>45</b>	Operating with Web Browser .....	93
<b>Picture Profiles</b> .....	<b>47</b>	Using Web Browser Control .....	97
Saving profiles .....	48	<b>USB media player</b> .....	<b>99</b>
Loading profiles .....	49	Function description .....	99
Editing profiles .....	50	Preparation .....	100
<b>Setup menu</b> .....	<b>51</b>	Playing back the files .....	102
Signal .....	51	Network environment (Multi Media Player only) .....	105
Control settings .....	55	Starting / ending Media Player .....	105
Multi display settings .....	58	Resume Play function .....	105
Input search .....	59	<b>Data Cloning</b> .....	<b>106</b>
Failover/Failback .....	60	Copying data to other display via LAN .....	106
Colour matching function .....	64	Copying the display data to the USB memory .....	108
Screensaver (For preventing image retention) .....	65	Copying the USB memory data to the display .....	109
Input label .....	66	<b>USB memory network settings</b> .....	<b>110</b>
Power management settings .....	67	Saving the LAN setting file to the USB memory device .....	110
Wobbling .....	68	Copying the USB memory data to the display .....	110
DIGITAL LINK out .....	68	<b>Controller ID function</b> .....	<b>111</b>
No activity power off .....	68	Setting the remote control's ID number .....	111
Power ON screen delay .....	69	Cancelling the setting of remote control's ID number (ID "0") .....	111
OSD language .....	69	<b>Entering characters</b> .....	<b>112</b>
Set up timer .....	69	<b>Preset Signals</b> .....	<b>113</b>
Date and time .....	70	<b>Shipping condition</b> .....	<b>115</b>
Network settings .....	70	<b>Troubleshooting</b> .....	<b>116</b>
USB media player settings .....	73	<b>Specifications</b> .....	<b>119</b>
Function button settings .....	74	<b>Software License</b> .....	<b>121</b>
Startup image settings .....	75		
Display orientation .....	77		
OSD position .....	77		
Menu display duration .....	77		
Menu transparency .....	77		
<b>Options Adjustments</b> .....	<b>78</b>		
<b>Using Network Function</b> .....	<b>84</b>		
Necessary environment for computers to be connected .....	84		

**WARNING: RISK OF ELECTRIC SHOCK  
DO NOT OPEN**



**WARNING: To reduce the risk of electric shock, do not remove cover or back. No user-serviceable parts inside. Refer servicing to qualified service personnel.**



The lightning flash with arrow-head within a triangle is intended to tell the user that parts inside the product are a risk of electric shock to persons.



The exclamation point within a triangle is intended to tell the user that important operating and servicing instructions are in the papers with the appliance.

**WARNING:**

**To prevent damage which may result in fire or shock hazard, do not expose this apparatus to rain or moisture.**

**Do not place containers with water (flower vase, cups, cosmetics, etc.) above the set. (including on shelves above, etc.)**

**WARNING:**

- 1) To prevent electric shock, do not remove cover. No user serviceable parts inside. Refer servicing to qualified service personnel.
- 2) Do not remove the grounding pin on the power plug. This apparatus is equipped with a three pin grounding-type power plug. This plug will only fit a grounding-type power outlet. This is a safety feature. If you are unable to insert the plug into the outlet, contact an electrician.  
Do not defeat the purpose of the grounding plug.

# Important Safety Instructions

- 1) Read these instructions.
- 2) Keep these instructions.
- 3) Heed all warnings.
- 4) Follow all instructions.
- 5) Do not use this apparatus near water.
- 6) Clean only with dry cloth.
- 7) Do not block any ventilation openings. Install in accordance with the manufacturer's instructions.
- 8) Do not install near any heat sources such as radiators, heat registers, stoves, or other apparatus (including amplifiers) that produce heat.
- 9) Do not defeat the safety purpose of the polarized or grounding-type plug. A polarized plug has two blades with one wider than the other. A grounding type plug has two blades and a third grounding prong. The wide blade or the third prong are provided for your safety. If the provided plug does not fit into your outlet, consult an electrician for replacement of the obsolete outlet.
- 10) Protect the power cord from being walked on or pinched particularly at plugs, convenience receptacles, and the point where they exit from the apparatus.
- 11) Only use attachments / accessories specified by the manufacturer.
- 12) Use only with the cart, stand, tripod, bracket, or table specified by the manufacturer, or sold with the apparatus. When a cart is used, use caution when moving the cart / apparatus combination to avoid injury from tip-over. 
- 13) Unplug this apparatus during lightning storms or when unused for long periods of time.
- 14) Refer all servicing to qualified service personnel. Servicing is required when the apparatus has been damaged in any way, such as power-supply cord or plug is damaged, liquid has been spilled or objects have fallen into the apparatus, the apparatus has been exposed to rain or moisture, does not operate normally, or has been dropped.
- 15) To prevent electric shock, ensure the grounding pin on the AC cord power plug is securely connected.

# FCC STATEMENT

This equipment has been tested and found to comply with the limits for a class A digital device, pursuant to Part 15 of the FCC Rules. These limits are designed to provide reasonable protection against harmful interference when the equipment is operated in a commercial environment. This equipment generates, uses and can radiate radio frequency energy and, if not installed and used in accordance with the instructions manual, may cause harmful interference to radio communications. Operation of this equipment in a residential area is likely to cause harmful interference in which case the user will be required to correct the interference at his own expense.

## FCC CAUTION:

**To assure continued compliance, follow the attached installation instructions and use only the provided power supply cord and DVI interface cable. Any changes or modifications not expressly approved by Panasonic Corp. of North America could void the user's authority to operate this device.**

Declaration of Verification

Model No.

TH-55VF1HU

Responsible Party:

Panasonic Corporation of North America  
Two Riverfront Plaza, Newark, New Jersey  
07102-5490

Contact Source:

Panasonic System Communications Company of  
North America  
1-877-655-2357

General Contact:

<http://shop.panasonic.com/support>

This device complies with Part 15 of the FCC Rules and all applicable IC RSS standards. Operation is subject to the following two conditions: (1) This device may not cause harmful interference, and (2) this device must accept any interference received, including interference that may cause undesired operation.

## CANADIAN NOTICE:

This Class A digital apparatus complies with Canadian ICES-003.

## WARNING:

- Not for use in a computer room as defined in the Standard for the Protection of Electronic Computer/ Data Processing Equipment, ANSI/NFPA 75.
- For permanently connected equipment, a readily accessible disconnect device shall be incorporated in the building installation wiring.
- For pluggable equipment, the socket-outlet shall be installed near the equipment and shall be easily accessible.

## Note:

Image retention may occur. If you display a still picture for an extended period, the image might remain on the screen. However, it will disappear when a general moving picture is displayed for a while.

## Trademark Credits

- Microsoft, Windows and Internet Explorer are the registered trademarks or trademarks of Microsoft Corporation in the United States and/or other countries.
- Macintosh, Mac, Mac OS, OS X and Safari are the trademarks of Apple Inc. registered in the United States and other countries.
- PjLink is a registered or pending trademark in Japan, the United States, and other countries and regions.
- HDMI, the HDMI Logo, and High-Definition Multimedia Interface are trademarks or registered trademarks of HDMI Licensing LLC in the United States and other countries.
- JavaScript is a registered trademark or a trademark of Oracle Corporation and its subsidiary and associated companies in the United States and/or other countries.
- RoomView, Crestron RoomView and Fusion RV are registered trademarks of Crestron Electronics, Inc. Crestron Connected is the trademark of Crestron Electronics, Inc.

Even if no special notation has been made of company or product trademarks, these trademarks have been fully respected.

# Important Safety Notice

## WARNING

- 1) To prevent damage which may result in fire or shock hazard, do not expose this appliance to dripping or splashing.  
Do not place containers with water (flower vase, cups, cosmetics, etc.) above the set. (including on shelves above, etc.)  
No naked flame sources, such as lighted candles, should be placed on / above the set.
- 2) To prevent electric shock, do not remove cover. No user serviceable parts inside. Refer servicing to qualified service personnel.
- 3) Do not remove the earthing pin on the power plug. This apparatus is equipped with a three pin earthing-type power plug. This plug will only fit an earthing-type power outlet. This is a safety feature. If you are unable to insert the plug into the outlet, contact an electrician.  
Do not defeat the purpose of the earthing plug.
- 4) To prevent electric shock, ensure the earthing pin on the AC cord power plug is securely connected.

## CAUTION

This appliance is intended for use in environments which are relatively free of electromagnetic fields.

Using this appliance near sources of strong electromagnetic fields or where electrical noise may overlap with the input signals could cause the picture and sound to wobble or cause interference such as noise to appear.

To avoid the possibility of harm to this appliance, keep it away from sources of strong electromagnetic fields.

## WARNING:

This equipment is compliant with Class A of CISPR32. In a residential environment this equipment may cause radio interference.

## IMPORTANT INFORMATION

If a display is not positioned in a sufficiently stable location, it can be potentially hazardous due to falling. Many injuries, particularly to children, can be avoided by taking simple precautions such as:

- Using cabinets or stands recommended by the manufacturer of the display.
- Only using furniture that can safely support the display.
- Ensuring the display is not overhanging the edge of the supporting furniture.
- Not placing the display on tall furniture (for example, cupboards or bookcases) without anchoring both the furniture and the display to a suitable support.
- Not standing the displays on cloth or other materials placed between the display and supporting furniture.
- Educating children about the dangers of climbing on furniture to reach the display or its controls.

**IMPORTANT: THE MOULDED PLUG  
FOR YOUR SAFETY, PLEASE READ THE  
FOLLOWING TEXT CAREFULLY.**

This display is supplied with a moulded three pin mains plug for your safety and convenience. A 10 amp fuse is fitted in this plug. Shall the fuse need to be replaced, please ensure that the replacement fuse has a rating of 10 amps and that it is approved by ASTA or BSI to BS1362.

Check for the ASTA mark  or the BSI mark  on the body of the fuse.

If the plug contains a removable fuse cover, you must ensure that it is refitted when the fuse is replaced.

If you lose the fuse cover the plug must not be used until a replacement cover is obtained.

A replacement fuse cover can be purchased from your local Panasonic dealer.  
Do not cut off the mains plug.

Do not use any other type of mains lead except the one supplied with this display.

The supplied mains lead and moulded plug are designed to be used with this display to avoid interference and for your safety.

If the socket outlet in your home is not suitable, get it changed by a qualified electrician.

If the plug or mains lead becomes damaged, purchase a replacement from an authorized dealer.

**WARNING : — THIS DISPLAY MUST BE EARTHED.**

**How to replace the fuse.**

Open the fuse compartment with a screwdriver and replace the fuse.

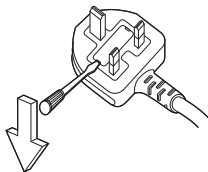

# Safety Precautions

## WARNING

### ■ Setup

**This LCD Display is for use only with the following optional accessories.**

**Use with any other type of optional accessories may cause instability which could result in the possibility of injury.**

(All of the following accessories are manufactured by Panasonic Corporation.)

- Installation Mount  
TY-VK55LV1  
TY-VK55LV2
- Cover-frame Kit  
TY-CF55VW1
- Early Warning Software  
ET-SWA100 series\*1
- Video Wall Manager  
TY-VUK10\*2

\*1: Suffix of the part number may differ depending on the license type.

\*2: Supports Ver1.4 or later.

### Note

- The part number of the optional accessories are subject to change without notice.

We are not responsible for any product damage, etc. caused by failures in the installation environment even during the warranty period.

Always be sure to ask a qualified technician to carry out set-up.

Small parts can present choking hazard if accidentally swallowed. Keep small parts away from young children. Discard unneeded small parts and other objects, including packaging materials and plastic bags/sheets to prevent them from being played with by young children, creating the potential risk of suffocation.

**Do not place the Display on sloped or unstable surfaces, and ensure that the Display does not hang over the edge of the base.**

- The Display may fall off or tip over.

**Install this unit at a location with minimal vibration and which can support the weight of the unit.**

- Dropping or falling of the unit may cause injury or malfunction.

**Do not place any objects on top of the Display.**

- If foreign objects or water get inside the Display, a short-circuit may occur which could result in fire or electric shock. If any foreign objects get inside the Display, please consult your local Panasonic dealer.

**Transport only in upright position!**

- Transporting the unit with its liquid crystal panel facing upright or downward may cause damage to the internal circuitry.

Ventilation should not be impeded by covering the ventilation openings with items such as newspapers, table cloths and curtains.

For sufficient ventilation, see page 10.

**Caution - For use only with UL Listed Wall Mount Bracket with minimum weight/load 25.0 kg (56.0 lbs).**

When installing the Display vertically, rotate clockwise and be sure that the Power Indicator comes to the downside.

(The Power Indicator is situated at the back.)

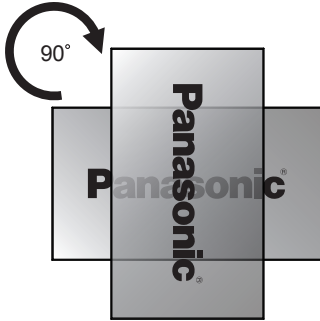

Heat is generated and it may cause fire or damage to the Display.

**Installation should be performed by installation professionals.**

Installing the Display incorrectly may lead to an accident that results in death or serious injury.

- Specified Installation Mount (Optional) or a mounting bracket that conform to VESA standards (VESA 400 x 400) must be used. (see page 10)
- Before installation, be sure to check if the mounting location has enough strength to support the weight of the LCD display and the wall hanging bracket for anti drop.
- If you terminate the use of the Display, ask professionals to remove the Display as soon as possible.

**When mounting the Display on the wall, prevent the mounting screws and power cable from contacting metal objects inside the wall.**

An electric shock may occur if they contact metal objects inside the wall.

**Do not place the display where it may be affected by salt or corrosive gas.**

- Doing so may cause the display to fall due to corrosion. Also, the unit may malfunction.

**Do not install the product to a place where the product is exposed to direct sunlight.**

- If the screen is exposed to direct sunlight, the liquid crystal panel may have adverse effect.

## ■ When using the LCD Display

The Display is designed to operate on 110 – 127 or 220 – 240 V AC, 50/60 Hz.

**Do not cover the ventilation holes.**

- Doing so may cause the Display to overheat, which can cause fire or damage to the Display.

**Do not stick any foreign objects into the Display.**

- Do not insert any metal or flammable objects into the ventilations holes or drop them onto the Display, as doing so can cause fire or electric shock.

**Do not remove the cover or modify it in any way.**

- High voltages which can cause severe electric shocks are present inside the Display. For any inspection, adjustment and repair work, please contact your local Panasonic dealer.

**Ensure that the mains plug is easily accessible.**

**The mains plug shall be connected to a mains socket outlet with a protective earthing connection.**

**Do not use any power supply cord other than that provided with this unit.**

- Doing so may cause short-circuit, generates heat, etc., which could cause electric shock or fire.

**Do not use the supplied power supply cord with any other devices.**

- Doing so could cause electric shock or fire.

**Securely insert the power supply plug as far as it will go.**

- If the plug is not fully inserted, heat may be generated which could cause fire. If the plug is damaged or the wall socket is loose, they shall not be used.

**Do not handle the power supply plug with wet hands.**

- Doing so may cause electric shocks.

**Do not do anything that may damage the power cable. When disconnecting the power cable, pull on the plug body, not the cable.**

- Do not damage the cable, make any modifications to it, place heavy objects on top of it, heat it, place it near any hot objects, twist it, bend it excessively or pull it. To do so may cause fire and electric shock. If the power cable is damaged, have it repaired at your local Panasonic dealer.

**Do not touch the power supply cord or the plug directly by hand when they are damaged.**

- Electric shock could occur.

**Do not remove covers and NEVER modify the Display yourself**

- Do not remove the rear cover as live parts are accessible when it is removed. There are no user serviceable parts inside. (High-voltage components may cause serious electrical shock.)
- Have the Display checked, adjusted, or repaired at your local Panasonic dealer.

**Keep the supplied AAA/R03/UM4 batteries out of reach of children. If accidentally swallowed, it will be harmful to the body.**

- Please contact a doctor immediately in case you doubt that the child may have swallowed it.



**If the Display is not going to be used for any prolonged length of time:**

- Unplug the power supply plug from the wall outlet.
- The power consumption is 0 W when the power is turned off with the <Main power switch> on the display. However, the power consumption is 0.5 W when the power is turned off with the remote control or <Power button (Unit)>. (see page 31)

**Picture noise may occur if you connect / disconnect the connection cables of the input terminals you are currently not watching, or if you turn the power of the video equipment on / off, but it is not a malfunction.**

**To prevent the spread of fire, keep candles or other open flames away from this product at all times.**



## CAUTION

**If problems or malfunction occur, stop using immediately.**

### ■ If problems occur, unplug the power supply plug.

- Smoke or an abnormal odour come out from the unit.
- No picture appears or no sound is heard, occasionally.
- Liquid such as water or foreign objects got inside the unit.
- The unit has deformed or broken parts.

**If you continue to use the unit in this condition, it could result in fire or electric shock.**

- Turn the power off immediately, unplug the power supply plug from the wall outlet, and then contact the dealer for repairs.
- To cut off the power supply to this Display completely, you need to unplug the power supply plug from the wall outlet.
- Repairing the unit yourself is dangerous, and shall never be done.
- To enable to unplug the power supply plug immediately, use the wall outlet which you can reach easily.

### ■ Do not touch the unit directly by hand when it is damaged.

**Electric shock could occur.**

### ■ When using the LCD Display

**Do not bring your hands, face or objects close to the ventilation holes of the Display.**

- Heated air comes out from the ventilation holes at the top of Display will be hot. Do not bring your hands or face, or objects which cannot withstand heat, close to this port, otherwise burns or deformation could result.

**At least 2 people are required to carry or unpack this unit.**

- If this is not observed, the unit may drop, resulting in injury.

**Be sure to disconnect all cables before moving the Display.**

- If the Display is moved while some of the cables are still connected, the cables may become damaged, and fire or electric shock could result.

**Disconnect the power supply plug from the wall socket as a safety precaution before carrying out any cleaning.**

- Electric shocks can result if this is not done.

**Clean the power cable regularly to prevent it becoming dusty.**

- If dust built up on the power cord plug, the resultant humidity can damage the insulation, which could result in fire. Pull the power cord plug out from the wall outlet and wipe the mains lead with a dry cloth.

### Do not step on, or hang from the display.

- They might tip over, or might be broken and it may result in injury. Pay special attention to the children.

### Do not reverse the polarity (+ and -) of the battery when inserting.

- Mishandling the battery may cause its explosion or leakage, resulting in fire, injury or damage to surrounding properties.
- Insert the battery correctly as instructed. (see page 13)

### Remove the batteries from the remote control transmitter when not using for a long period of time.

- The battery may leak, heat, ignite or burst, resulting in fire or damage to surrounding properties.

### Do not burn or breakup batteries.

- Batteries must not be exposed to excessive heat such as sunshine, fire or the like.

### Do not turn the Display upside down.

### Do not position the unit with its liquid crystal panel facing upright.

# Precautions for use

## Cautions when installing

### Do not set up the Display outdoors.

- The Display is designed for indoor use.

### Environmental temperature to use this unit

- When using the unit where it is below 1 400 m (4 593 ft) above sea level: 0 °C to 40 °C (32 °F to 104 °F)
- When using the unit at high altitudes (1 400 m (4 593 ft) and higher and below 2 800 m (9 186 ft) above sea level): 0 °C to 35 °C (32 °F to 95 °F)

### Do not install the unit where it is 2 800 m (9 186 ft) and higher above sea level.

- Failure to do so may shorten the life of the internal parts and result in malfunctions.

### We are not responsible for any product damage, etc. caused by failures in the installation environment even during the warranty period.

### Do not place the display where it may be affected by salt or corrosive gas.

- Failure to do so may shorten the life of the internal parts and result in malfunctions due to corrosion.

### Required space for ventilation

- For the outermost periphery of the display, leave a space of 10 cm (3.94") or more at the top, bottom, left and right.

At the rear, leave a space of 5 cm (1.97") or more.

### About the screws used for the mounting bracket that conforms to VESA standards

Screw pitch for installation	Depth of screw hole	Screw (quantity)
400 mm × 400 mm	10 mm	M6 (4)

### Do not grab the liquid crystal panel.

- Do not forcibly press the liquid crystal panel, or push it with a pointed object. Applying a strong force to the liquid crystal panel will cause unevenness of the screen display, resulting in malfunction.

### Depending on the temperature or humidity conditions, uneven brightness may be observed. This is not a malfunction.

- This unevenness will disappear while applying current continuously. If not, consult the distributor.

### ■ Note regarding security

#### When using this product, take safety measures against the following incidents.

- Personal information being leaked via this product
- Unauthorized operation of this product by a malicious third party
- Interfering or stopping of this product by a malicious third party

### Take sufficient security measures. (see page 93, 95)

- Set a password for the LAN control and restrict the users who can log in.
- Make your password difficult to guess as much as possible.
- Change your password periodically.
- Panasonic Corporation or its affiliate companies will never ask for your password directly. Do not divulge your password in case you receive such inquiries.
- The connecting network must be secured by a firewall, etc.
- When disposing the product, initialize the data before disposing.  
[Shipping] (see page 115)

## Cleaning and maintenance

**The front of the liquid crystal panel has been specially treated. Wipe the surface of the liquid crystal panel gently using only a cleaning cloth or a soft, lint-free cloth.**

- If the surface is particularly dirty, wipe with a soft, lint-free cloth which has been soaked in pure water or water in which neutral detergent has been diluted 100 times, and then wipe it evenly with a dry cloth of the same type until the surface is dry.
- Do not scratch or hit the surface of the panel with fingernails or other hard objects, otherwise the surface may become damaged. Furthermore, avoid contact with volatile substances such as insect sprays, solvents and thinner, otherwise the quality of the surface may be adversely affected.

**If the cabinet becomes dirty, wipe it with a soft, dry cloth.**

- If the cabinet is particularly dirty, soak the cloth in water to which a small amount of neutral detergent has been added and then wring the cloth dry. Use this cloth to wipe the cabinet, and then wipe it dry with a dry cloth.
- Do not allow any detergent to come into direct contact with the surface of the Display. If water droplets get inside the unit, operating problems may result.
- Avoid contact with volatile substances such as insect sprays, solvents and thinner, otherwise the quality of the cabinet surface may be adversely affected or the coating may peel off. Furthermore, do not leave it for long periods in contact with articles made from rubber or PVC.

**Usage of a chemical cloth**

- Do not use a chemical cloth for the panel surface.
- Follow the instructions for the chemical cloth to use it for the cabinet.

## Wired LAN

**When setting up the Display at a place, where electric static occurs often, take a sufficient anti-static measure before start using.**

- When the Display is used at a location, where static electricity occurs often, such as on a carpet, a wired LAN communication is disconnected more often. In that case, remove static electricity and the noise source that may cause problems with an antistatic mat, and re-connect the wired LAN.
- In rare cases, the LAN connection is disabled due to static electricity or noise. In that case, turn off the power of the Display and the connected devices once and then re-turn on the power.

**The Display may not work properly due to strong radio wave from the broadcast station or the radio.**

- If there is any facility or equipment, which outputs strong radio wave, near the installation location, set up the Display at a location sufficiently far from the source of the radio wave. Or, wrap the LAN cable connected to the LAN terminal by using a piece of metal foil or a metal pipe, of which is grounded at both ends.

## Disposal

**When disposing the product, ask your local authority or dealer about the correct methods of disposal.**

# Accessories

## Accessories Supply

Check that you have the accessories and items shown

### Operating Instructions (CD-ROM × 1)

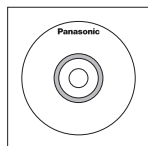

### Remote Control Transmitter × 1

- N2QAYA000093



### LAN cable (CAT5e) × 1

(Approx. 2 m)

- TZZ00001774A



### External IR Receiver × 1

(Approx. 1.8 m)

- DPVF1180ZA

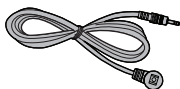

### Batteries for the Remote Control Transmitter

(AAA/R03/UM4 type × 2)

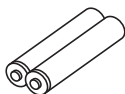

### Clamper × 3

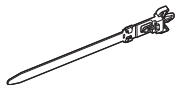

### Power supply cord

(Approx. 2 m)

TH-55VF1HU

- 1JP155AF1U

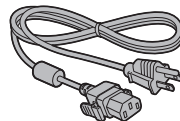

TH-55VF1HW

- 1JP155AF1W

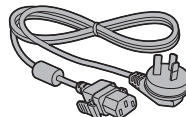

- 2JP155AF1W

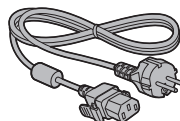

- 3JP155AF1W

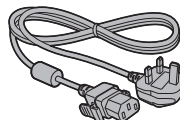

### Attention

- Store small parts in an appropriate manner, and keep them away from young children.
- In case you lost accessories, please consult your dealer.
- Dispose the packaging materials appropriately after taking out the items.

## Remote Control Batteries

1. Pull and hold the hook, then open the battery cover.

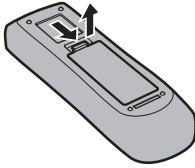

2. Insert batteries - note correct polarity (+ and -).

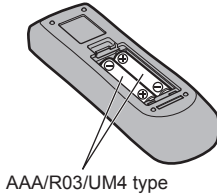

3. Replace the cover.

### Helpful Hint

- For frequent remote control users, replace old batteries with Alkaline batteries for longer life.



### Precaution on battery use

Incorrect installation can cause battery leakage and corrosion that will damage the remote control transmitter.

Disposal of batteries should be in an environment-friendly manner.

#### Observe the following precaution:

1. Batteries shall always be replaced as a pair. Always use new batteries when replacing the old set.
2. Do not combine a used battery with a new one.
3. Do not mix battery types (example: "Zinc Carbon" with "Alkaline").
4. Do not attempt to charge, short-circuit, disassemble, heat or burn used batteries.
5. Battery replacement is necessary when remote control acts sporadically or stops operating the Display set.
6. Do not burn or breakup batteries.
7. Batteries must not be exposed to excessive heat such as sunshine, fire or the like.

## VESA Mounting

To mount this Display using a VESA mounting bracket (commercially available):

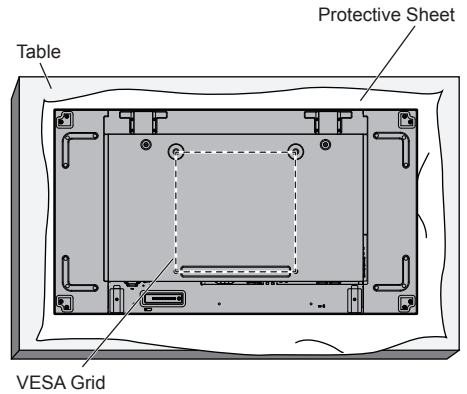

1. Lay a protective sheet on a flat table, which was wrapped around this Display when it was packaged, beneath the screen surface so as not to scratch the screen face.
2. Ensure you have all accessories for mounting this Display.
3. Follow the instructions that came with the mounting kit. Failing to follow the correct mounting procedures could result in damage to the equipment, or injury to the user or install personnel. The product warranty does not cover the damage caused by improper installation even during the warranty period.

# Cautions when installing multi displays

## Securing gaps between displays

The displays slightly expand due to heat after the power is turned on. When installing multiple displays, securing a gap of 0.5 mm is required on the left, right, top and bottom respectively between displays in anticipation of display contact caused by expansion.

If the gap is less than 0.5 mm, image failure may occur due to display distortion caused by heat expansion.

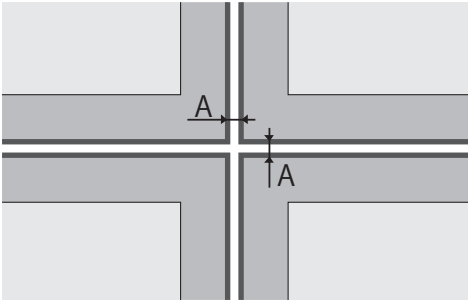

A: Gap between displays (left, right, top and bottom respectively), 0.5 mm

**Do not allow the corners of displays to hit each other.**

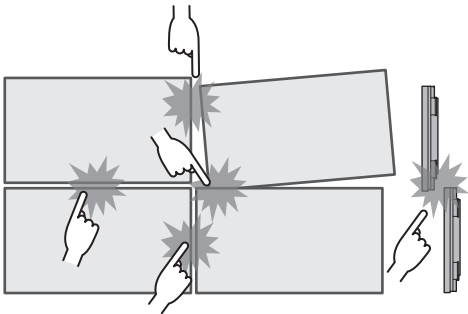

After the displays are attached to the brackets at the back and the positions are adjusted, do not adjust the positions of the front sides using the plate, etc. Doing so may cause image failure due to display distortion.

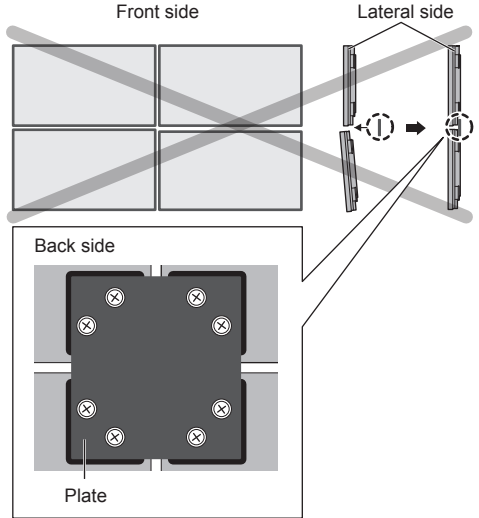

# Cautions when moving

The display has handles for carrying. Hold them when moving.

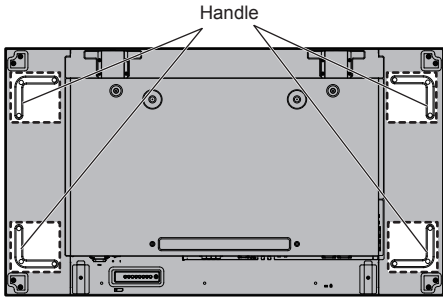

**Note**

- Do not hold parts other than the handles.
- At least 2 people are required to carry this unit.  
If this is not observed, the unit may drop, resulting in injury.
- When carrying the unit, keep the liquid crystal panel upright.  
Carrying the unit with the surface of the liquid crystal panel facing up or down may cause deformation of the panel, or internal damage.
- Do not hold the upper, lower, right and left frames or the corners of the unit. Do not hold the front surface of the liquid crystal panel. Also, do not hit such parts.  
Doing so may damage the liquid crystal panel.  
Also, the panel may crack, resulting in injury.
- When carrying the display, do not apply a twisting force to the panel surface.

# LCD panel protection

Protection materials for the LCD panel have been attached on this unit.

Remove one on the bottom surface before installation and the other four on the front surface (left, right, top and bottom) after installation.

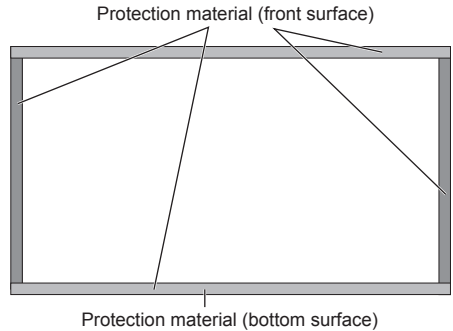

# Eyebolt

The display has holes for attaching eyebolts (M10). When installing, use them to suspend the display. Use the eyebolt only for temporary hanging or movement.

Eyebolt (commercially available) mounting positions

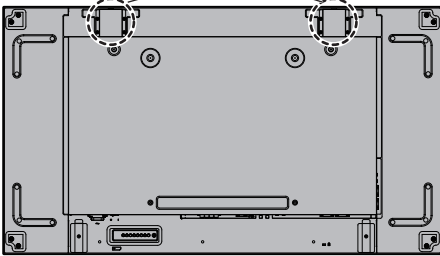

## Note

- Suspension and installation should be performed by an installation professional.
- Do not install the Display using only 1 eyebolt.
- Use the eyebolt of size M10, which fulfils the load condition of the mass of the product.
- After installation, remove the eyebolts, and close the holes using the eyebolt caps removed when attaching the eyebolts.

# Kensington security

The security slot of this unit is compatible with the Kensington security cables.

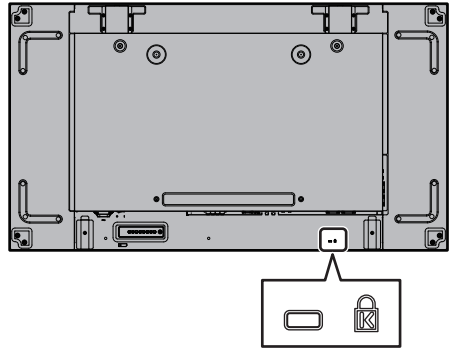



# Connections

## AC cord connection and fixing

Back of the unit

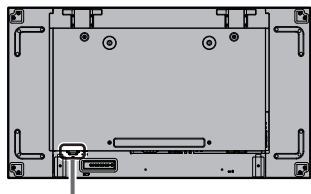

### AC cord fixing

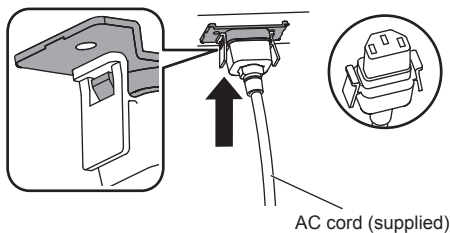

### Plug the connector into the display unit.

Plug the connector until it clicks.

#### Note

- Make sure that the connector is locked on both the left and right sides.

### Unplug the AC cord

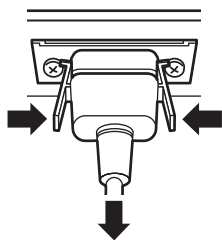

Unplug the connector pressing the two knobs.

#### Note

- When disconnecting the AC cord, be absolutely sure to disconnect the AC cord plug at the socket outlet first.
- The supplied AC cord set is for this unit exclusive use. Do not use this for other purposes.

## Cable fixing

#### Note

- 3 clampers are supplied with this unit. Fix the cables at 3 locations using the holes for clampers as shown below.

If you need more clampers, purchase them from your dealer. (Available from the customer service)

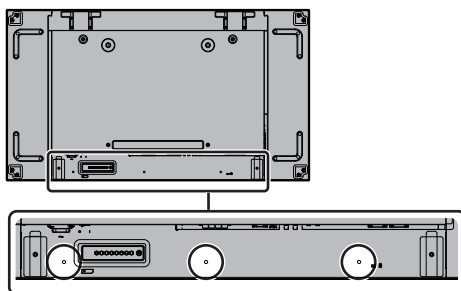

### 1. Attach the clamper

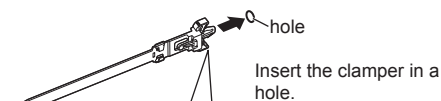

To remove from the unit:

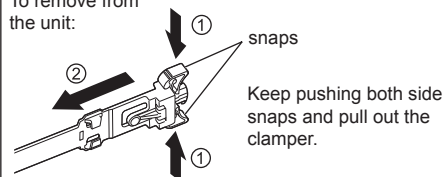

### 2. Bundle the cables

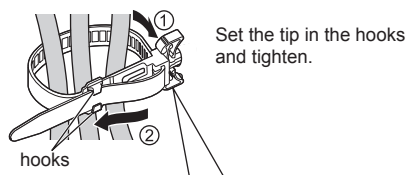

To loosen:

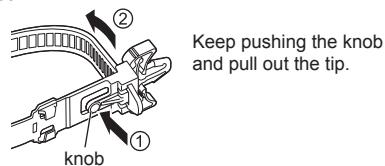

## Video equipment connection

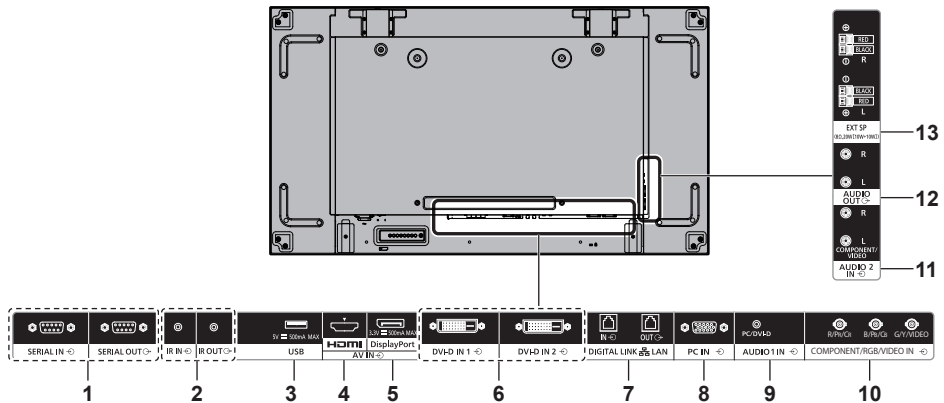

### 1 SERIAL IN, SERIAL OUT:

**SERIAL Input / Output Terminal**  
Control the Display by connecting to PC.  
(see page 26)

### 2 IR IN, IR OUT:

**Infrared Signal Input / Output Terminal**  
Use this when operating more than one display with one remote control.  
It is possible to receive signal from the remote control by connecting the supplied external IR receiver to the IR IN terminal.  
(see page 29)

### 3 USB:

**USB Memory Terminal**  
Connect USB memory to use [USB media player] function or to read files. Also, this can be used to supply power of up to 5V/500mA to an external device when the picture is displayed.  
(see page 30, 99)

### 4 AV IN (HDMI):

**HDMI Input Terminal**  
Connect to video equipment such as VCR or DVD player, etc.  
(see page 20)

### 5 AV IN (DisplayPort):

**DisplayPort Input Terminal**  
Connect to PC or video equipment with DisplayPort output terminal.  
(see page 21)

### 6 DVI-D IN 1, DVI-D IN 2:

**DVI-D Input Terminal**  
Connect to PC or video equipment with DVI-D output.  
(see page 22)

### 7 DIGITAL LINK / LAN IN/OUT:

**DIGITAL LINK / LAN Input / Output Terminal**  
Connect to a device that sends video and audio signals via the DIGITAL LINK terminal.  
Alternatively, control the display by connecting to Network.  
Also, when displaying the picture by daisy chaining multiple displays, connect to the other display.  
(see page 24, 84)

### 8 PC IN:

**PC Input Terminal**  
Connect to video terminal of PC, video equipment with "YPbPr / YCbCr" or "RGB" output.  
(see page 23)

### 9 AUDIO1 IN:

**Audio input terminal shared with DVI-D IN 1 / 2 and PC IN**  
(see page 22, 23)

<b>10 COMPONENT / RGB / VIDEO IN:</b>	<p><b>COMPONENT / RGB Video Input Terminal (R/Pr/Cr, B/Pb/Cb, G/Y)</b></p> <p>Connect to video equipment with "YPbPr / YCbCr" or "RGB" output. (see page 26)</p> <p><b>Composite Video Input Terminal (VIDEO)</b></p> <p>Connect to video equipment with Composite signal output. (see page 25)</p>
<b>11 AUDIO2 IN:</b>	<p><b>Audio Input Terminal shared with COMPONENT/RGB IN and VIDEO IN</b></p> <p>(see page 25, 26)</p>
<b>12 AUDIO OUT:</b>	<p><b>Analogue Audio Output Terminal</b></p> <p>Connect to audio equipment with analogue audio input terminal. (see page 29)</p>
<b>13 EXT SP:</b>	<p><b>Speaker Terminal</b></p> <p>Connect to external speaker. (see page 30)</p>

## Before connecting

- Before connecting cables, carefully read the operating instructions for the external device to be connected.
- Turn off the power of all devices before connecting cables.
- Take note of the following points before connecting the cables. Failure to do so may result in malfunctions.
  - When connecting a cable to the unit or a device connected to the unit itself, touch any nearby metallic objects to eliminate static electricity from your body before performing work.
  - Do not use unnecessarily long cables to connect a device to the unit or to the unit body. The longer the cable, the more susceptible to noise it becomes. Since using a cable while it is wound makes it act like an antenna, it is more susceptible to noise.
  - When connecting cables, connect GND first, then insert the connecting terminal of the connecting device in a straight manner.
- Acquire any connection cable necessary to connect the external device to the system that is neither supplied with the device nor available as an option.
- If the outer shape of the plug of a connection cable is large, it may come in contact with the plug of an adjacent connection cable. Use a connection cable with the suitable plug size for the terminal alignment.
- If video signals from video equipment contain too much jitter, the images on the screen may wobble. In this case, a time base corrector (TBC) must be connected.
- When the sync signals output from PC or video equipment are disturbed, for example, when changing settings of video output, the colour of the video may be disturbed temporarily.
- The unit accepts Composite video signals, YCbCr/YPbPr signals, analogue RGB signals and digital signals.
- Some PC models are not compatible with the unit.
- Use cable compensator when you connect devices to the unit using long cables. Otherwise the image may not display properly.
- Refer to "Preset Signals" (see page 113) for the types of video signals that can be displayed with the unit.

## HDMI terminal connection

### Note

- Video equipment and HDMI cable shown are not supplied with this unit.
- Some HDMI equipment may not be able to display picture.
- For audio, it is also possible to use AUDIO1 IN or AUDIO2 IN terminal input. (For [Audio input select] function, see page 79.)
- This Display does not support HDMI-CEC (HDMI Consumer Electronics Control) (VIERA LINK).

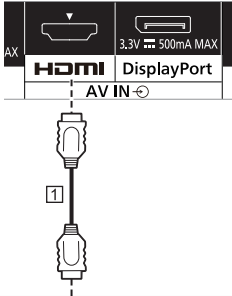

- ① HDMI cable (commercially available)
- ② Video Cassette Recorder
- ③ DVD Player
- ④ PC

## Pin assignments and signal names for HDMI Terminal

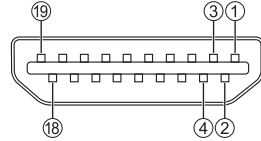

Pin No.	Signal name
①	T.M.D.S Data2+
②	T.M.D.S Data2 Shield
③	T.M.D.S Data2-
④	T.M.D.S Data1+
⑤	T.M.D.S Data1 Shield
⑥	T.M.D.S Data1-
⑦	T.M.D.S Data0+
⑧	T.M.D.S Data0 Shield
⑨	T.M.D.S Data0-
⑩	T.M.D.S Clock+
⑪	T.M.D.S Clock Shield
⑫	T.M.D.S Clock-
⑬	_____
⑭	_____
⑮	SCL
⑯	SDA
⑰	DDC/CEC Ground
⑱	+5V DC
⑲	Hot Plug Detect

## DisplayPort terminal connection

### Note

- Additional computer and cables shown are not supplied with this set.
- Only Dual Mode (DP++) is compatible with DisplayPort terminal.

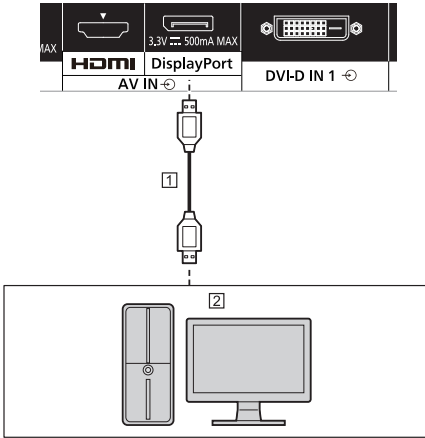

- 1 DisplayPort cable (commercially available)  
 2 PC with DisplayPort output

### Note

- In connecting with PC which uses early chipsets or graphic cards compatible with DisplayPort, if the DisplayPort output of the PC is connected to this unit, malfunction of this unit or the PC may occur. In that case, turn the power of the unit or the PC off, and then turn it on again.

When inputting DisplayPort output to this unit, it is recommended to use the PC which the newest Chipset and Graphics Cards are used.

## Pin assignments and signal names for DisplayPort

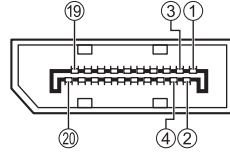

Pin No.	Signal Name
1	ML_Lane 3 (n)
2	GND (Ground)
3	ML_Lane 3 (p)
4	ML_Lane 2 (n)
5	GND (Ground)
6	ML_Lane 2 (p)
7	ML_Lane 1 (n)
8	GND (Ground)
9	ML_Lane 1 (p)
10	ML_Lane 0 (n)
11	GND (Ground)
12	ML_Lane 0 (p)
13	CONFIG1
14	CONFIG2
15	AUX_CH (p)
16	GND (Ground)
17	AUX_CH (n)
18	Hot Plug Detect
19	GND (Ground)
20	+ 3.3 V DC output

## DVI-D IN 1 / DVI-D IN 2 terminal connection

### Note

- Video equipment, DVI-D cable and audio cable shown are not supplied with this unit.
- DVI-D IN terminal is for Single Link only.
- For audio, it is also possible to use AUDIO2 IN terminal input. (For [Audio input select] function, see page 79.)

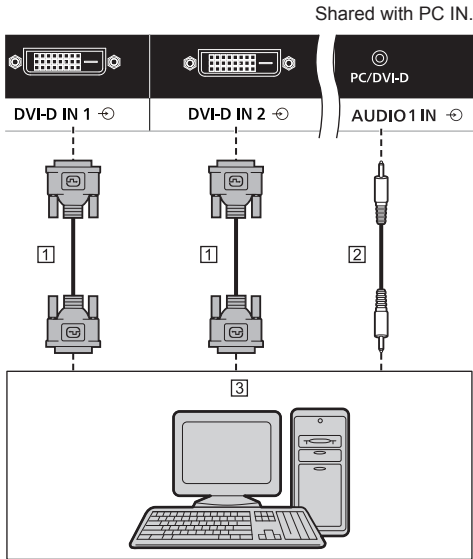

- 1 DVI-D cable (commercially available)
- 2 Stereo mini plug (M3) cable (commercially available)
- 3 PC with DVI-D video out

## Pin assignments and signal names for DVI-D Input

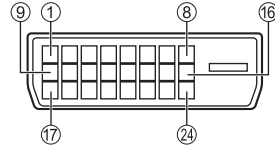

Pin No.	Signal Name
1	T.M.D.S. data 2-
2	T.M.D.S. data 2+
3	T.M.D.S. data 2 shield
4	_____
5	_____
6	DDC clock
7	DDC data
8	_____
9	T.M.D.S. data 1-
10	T.M.D.S. data 1+
11	T.M.D.S. data 1 shield
12	_____
13	_____
14	+5 V DC
15	GND (Ground)
16	Hot plug detect
17	T.M.D.S. data 0-
18	T.M.D.S. data 0+
19	T.M.D.S. data 0 shield
20	_____
21	_____
22	T.M.D.S. clock shield
23	T.M.D.S. clock+
24	T.M.D.S. clock-

## PC IN terminal connection

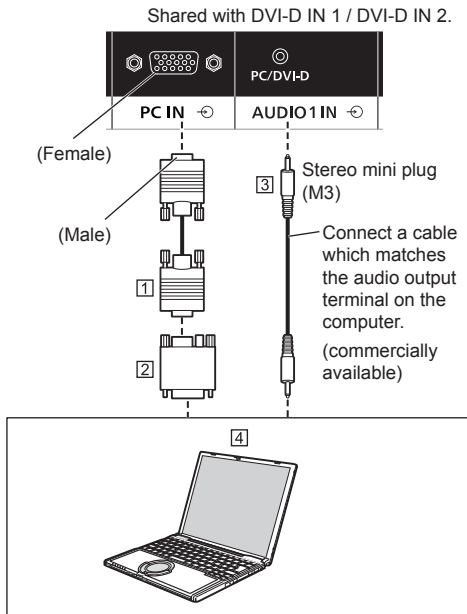

- ① Mini D-sub 15p cable (commercially available)
- ② Conversion adapter (if necessary) (commercially available)
- ③ Stereo mini plug (M3) cable (commercially available)
- ④ PC

### The type of computer signal that can be connected

- With regard to the typical PC input signals that are described in "Preset Signals" (see page 113), adjustment values such as for the standard picture positions and sizes have already been stored in this unit.  
(Computer signals which can be input are those with a horizontal scanning frequency of 30 to 110 kHz and vertical scanning frequency of 48 to 120 Hz.)
- The display resolution is a maximum of 1 440 × 1 080 dots when the aspect mode is set to [4:3], and 1 920 × 1 080 dots when the aspect mode is set to [16:9]. If the display resolution exceeds these maximums, it may not be possible to show fine detail with sufficient clarity.
- In [ENGLISH(US)] OSD language, [16:9] is displayed as [FULL].

#### Note

- Additional computer, cables and conversion adapter shown are not supplied with this set.

- Component Input is possible with the pin 1, 2, 3 of the Mini D-sub 15P Connector.

Change the [Component/RGB-in select] setting in the [Signal] menu to [Component] (when Component signal connection) or [RGB] (when RGB signal connection). (see page 52)

- The PC IN terminal is DDC2B-compatible. If the computer being connected is not DDC2B-compatible, you will need to make setting changes to the computer at the time of connection.
- There is no need to use an adapter for computers with DOS/V compatible Mini D-sub 15P terminal.
- Do not set the horizontal and vertical scanning frequencies for PC signals which are above or below the specified frequency range.
- For audio, it is also possible to use AUDIO2 IN terminal input. (For [Audio input select] function, see page 79.)

### Pin assignments and signal names for PC Input Terminal (Mini D-sub 15P)



Pin No.	Signal Name
①	R (P <sub>R</sub> /C <sub>R</sub> )
②	G (Y)
③	B (P <sub>B</sub> /C <sub>B</sub> )
④	NC (not connected)
⑤	GND (Ground)
⑥	GND (Ground)
⑦	GND (Ground)
⑧	GND (Ground)
⑨	+5 V DC
⑩	GND (Ground)
⑪	NC (not connected)
⑫	SDA
⑬	HD/SYNC
⑭	VD
⑮	SCL

## DIGITAL LINK IN / OUT terminal connection

Twisted pair cable transmitters such as the Panasonic Digital Interface Box (ET-YFB100G) or the DIGITAL LINK Switcher (ET-YFB200G) use twisted pair cables to transmit inputted video and audio signals, and these digital signals can be input to the Display via the DIGITAL LINK terminal.

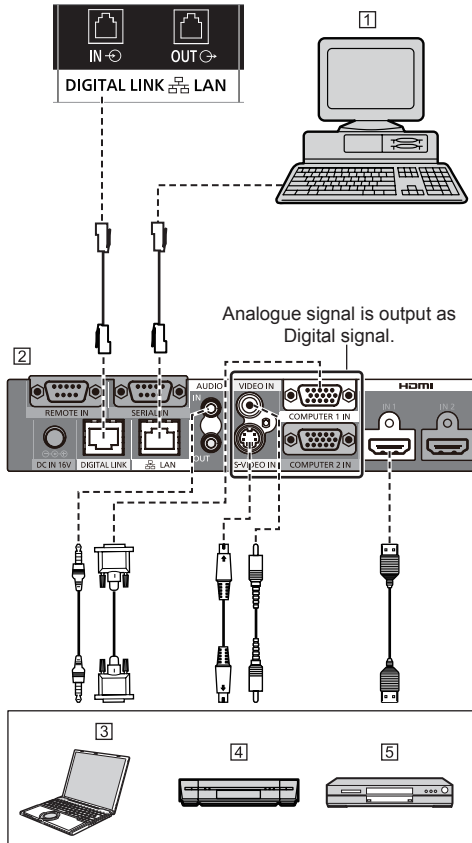

### Note

- Video equipment and connection cables are not supplied with this unit.
- When connecting with DIGITAL LINK, be sure to configure each of the [Network settings] settings. (see page 70)

For the cautions for DIGITAL LINK setting and connection, see page 85.

- Corresponding signal for DIGITAL LINK input is the same as that of HDMI input. (see page 113)

- 1 PC to control the unit
- 2 Example: Panasonic ET-YFB100G
- 3 PC
- 4 Video Cassette Recorder
- 5 DVD Player



## Daisy chain connection

It is possible to daisy chain multiple displays when displaying the picture on multi screen, etc.

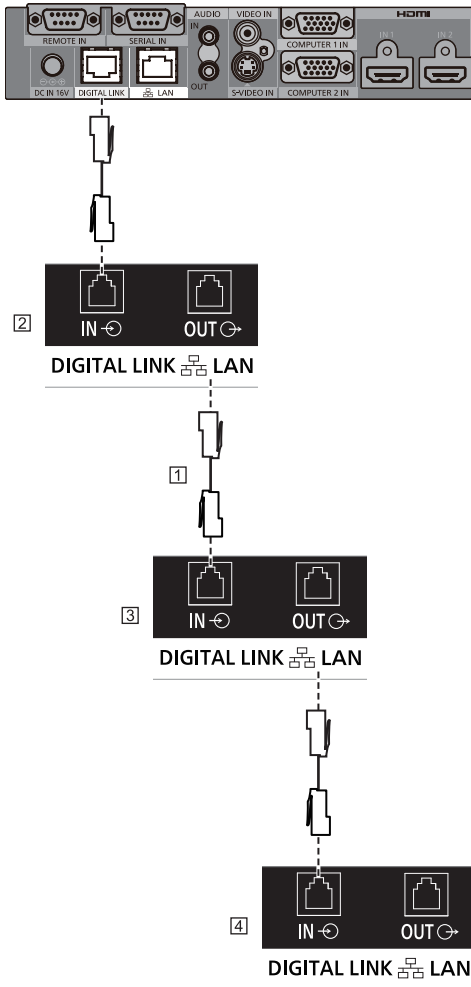

- ① LAN cable (CAT5e) (supplied)
- ② First display
- ③ Second display
- ④ Third display

### Note

- The cable for daisy chain connection is supplied with this unit. To connect the displays, use the supplied cable.
- Up to 10 displays can be connected with a daisy chain. However, the number of connectable displays may be limited depending on the cables, signals, the devices used, etc.
- When daisy chaining, it may take time for images to appear on all the displays.
- HDCP can be supported for up to 8 displays for a daisy chain.
- Even if the DIGITAL LINK OUT terminal of this unit is connected to the DIGITAL LINK input terminal of another device, audio and video are not output.

## VIDEO IN terminal connection

### Note

- Video equipment, connection cables and conversion plugs are not supplied with this unit.
- For audio, it is also possible to use AUDIO1 IN terminal input. (For [Audio input select] function, see page 79.)

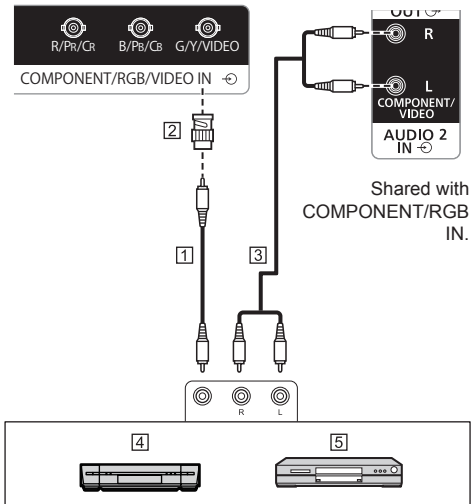

- ① Video pin cable (commercially available)
- ② Pin-BNC conversion plug (commercially available)
- ③ Stereo audio cable (commercially available)
- ④ Video Cassette Recorder
- ⑤ DVD Player

## COMPONENT/RGB IN terminal connection

### Note

- Video equipment, cables and conversion adapter shown are not supplied with this unit.

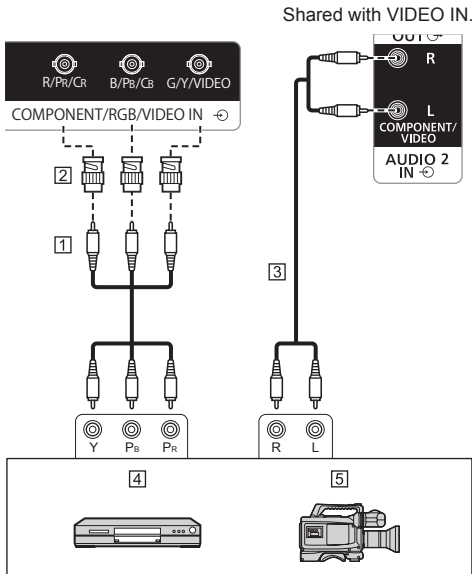

- 1 Video pin cable (commercially available)
- 2 Pin-BNC conversion plug (commercially available)
- 3 Stereo audio cable (commercially available)
- 4 DVD Player
- 5 RGB camera

### Note

- In accordance with the input signal connected to COMPONENT/RGB IN terminal, select the input [Component] or [RGB] in [Signal] - [Component/RGB-in select]. (see page 52)
- The RGB signal input to COMPONENT/RGB IN terminal corresponds to "SYNC ON G" only.
- For audio, it is also possible to use AUDIO1 IN terminal input. (For [Audio input select] function, see page 79.)

## SERIAL terminal connection

The SERIAL terminal conforms to the RS-232C interface specification, so that the Display can be controlled by a computer which is connected to this terminal.

### Note

- Additional computer and cables shown are not supplied with this set.

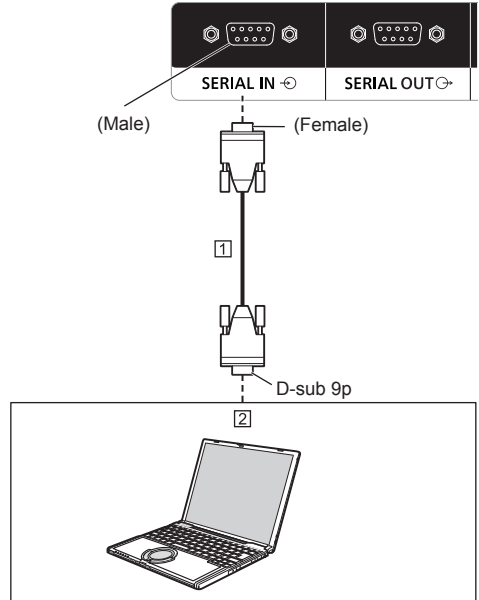

- 1 RS-232C Straight cable (commercially available)
- 2 PC

### Note

- Use the RS-232C straight cable to connect the computer to the Display.

It is possible to daisy chain multiple displays, and then control the specific display with PC.

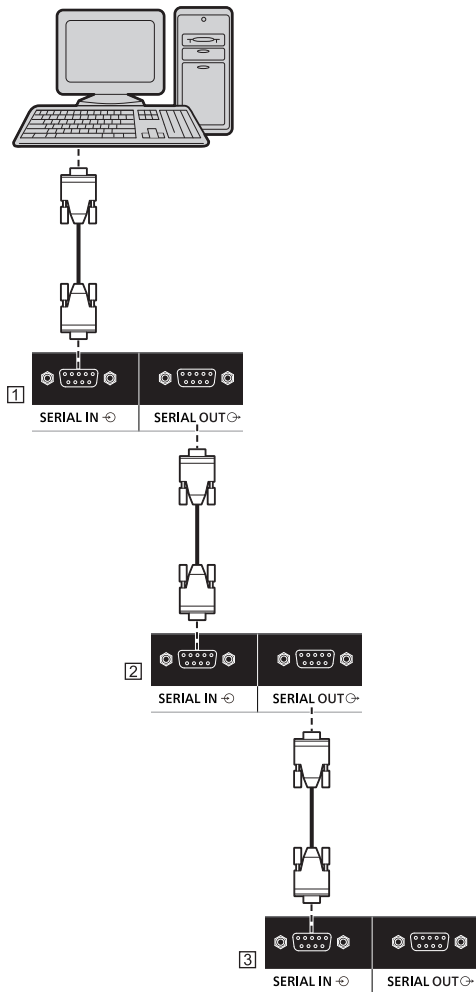

- 1 First display
- 2 Second display
- 3 Third display

**Note**

- When daisy chaining, set [Serial daisy chain position]. (see page 56)
- When daisy chaining, use a straight cable which pin No. ② to ⑥ are hard wired.

**Pin assignments and signal names for SERIAL Terminal**

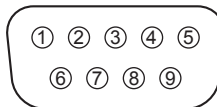

Pin No.	Signal Name	
①	NC (not connected)	
②	RXD	
③	TXD	
④	Non use	
⑤	GND (Ground)	
⑥	Non use	
⑦	RTS	} Shorted in this set
⑧	CTS	
⑨	NC (not connected)	

These signal names are those of computer specifications.

**Communication parameters**

- Signal level: RS-232C compliant
- Synchronization method: Asynchronous
- Baud rate: 9600 bps
- Parity: None
- Character length: 8 bits
- Stop bit: 1 bit
- Flow control: None

## Basic format for control data

The transmission of control data from the computer starts with a STX signal, followed by the command, the parameters, and lastly an ETX signal in that order. Add the parameter as required, in accordance with the control detail.

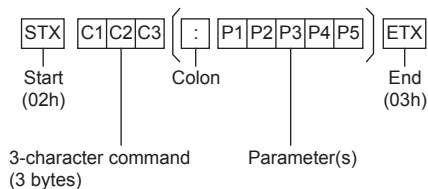

## Command

Command	Parameter	Control details
PON	None	Power ON
POF	None	Power OFF
AVL	***	Volume 000 - 100
AMT	0	Audio MUTE OFF
	1	Audio MUTE ON
IMS	None	Input select (toggle)
	HM1	HDMI input (HDMI)
	DP1	DisplayPort input (DisplayPort)
	DL1	DIGITAL LINK input (DIGITAL LINK)
	DV1	DVI-D IN 1 input (DVI-D1)
	DV2	DVI-D IN 2 input (DVI-D2)
	PC1	PC IN input (PC)
	VD1	VIDEO input (VIDEO)
	YP1	COMPONENT input (COMPONENT/RGB IN)
UD1	USB input (USB)	
DAM	None	Screen mode select (toggle)
	ZOOM	Zoom1
	FULL	16:9
	NORM	4:3
	ZOM2	Zoom2

## Note

- If multiple commands are transmitted, be sure to wait for the response for the first command to come from this unit before sending the next command. When sending a command which does not require parameter, a colon (:) is not needed.
- If an incorrect command is sent by mistake, this unit will send an "ER401" command back to the computer.
- In Standby condition (power OFF with remote control or <Power button (Unit)>), the unit responds to PON command only.
- When [Serial ID function] (see page 55) is set to [On], only the command that matches the display ID can be operated.

As the format, add the following header.

```
AD94;RAD=<XXX>;
```

For display ID, insert 001 to 100 or 000 for <XXX>.

For group ID, insert AAA (for A) to GGG (for G) for <XXX>.

- Consult your local Panasonic dealer for detail instructions on command usage.  
For more details, visit the following web site.  
<https://panasonic.net/cns/prodisplays/>

## IR IN/IR OUT terminal connection

Connect the IR cable from the IR OUT terminal of the first display to the IR IN terminal of the second display.

The infrared signal of the first display is sent to the second display.

In this case, the IR (infrared ray reception on the remote control sensor) on the second display does not operate.

Repeating the above connections enables the daisy chain connection.

It is possible to receive signal from the remote control by connecting the supplied external IR receiver to the IR IN terminal.

### Note

- Connection cables are not supplied with this unit.
- While controlling this display, if the external IR receiver or the IR cable is connected to the IR IN terminal, the control is performed only with this terminal.
- However, [Control settings] - [IR control] can be selected. (see page 55)

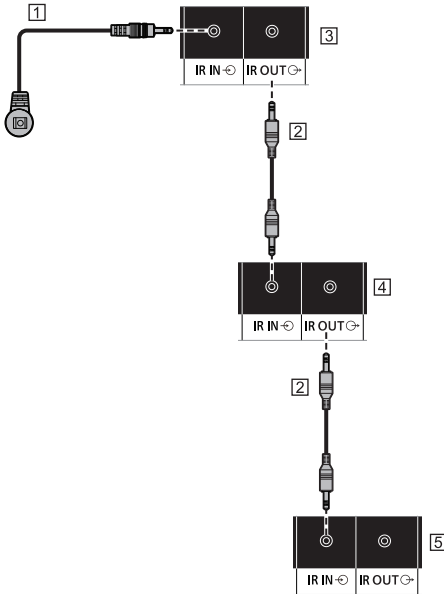

- 1 External IR Receiver (supplied)
- 2 IR cable
- 3 First display
- 4 Second display
- 5 Third display

## AUDIO OUT terminal connection

### Note

- Audio equipment and the cable shown are not supplied with this set.

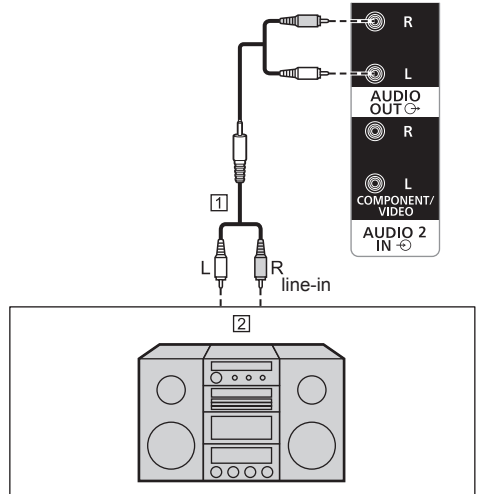

- 1 Stereo audio cable (commercially available)
- 2 Audio equipment

### Note

- To output sound from AUDIO OUT terminal of the unit, be sure to set [Output select] in the [Sound] menu to [AUDIO OUT]. (see page 44)

## USB terminal connection

Connect the USB memory to use [USB media player].  
(see page 99)

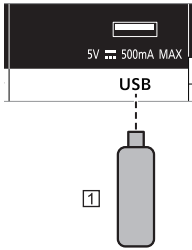

① USB memory device

### Pin assignments and signal names for USB Terminal

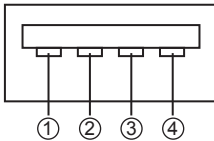

Pin No.	Signal name
①	+5 V DC
②	DATA -
③	DATA +
④	GND (Ground)

Power of up to 5V/500mA can be supplied to an external device when the picture is displayed.

- If the electric current exceeding the power supplying capability is applied, the output is blocked, and the following message is displayed.

[USB DC5V OUT overload. Please remove cable or equipment, then turn the display off/on.]

In this case, remove the equipment and then turn the power off/on using the remote control, etc.

#### Note

- Depending on the type of a USB memory device, it may come in contact with the periphery such as a back cover, and cannot be attached. Use a commercially sold extension cable, or use a small type of a USB memory device connectable to this unit.
- Depending on the USB memory, the access lamp may remain blinking even when it is not being accessed. In this case, remove the device after switching to the input other than USB.

Also, when reading the user image, remove the device after the menu screen display finishes (see page 51). When performing the data cloning, remove the device after the completion screen is displayed. (see page 106)

## Speaker terminal connection

Please use 8 Ω/10 W speaker.

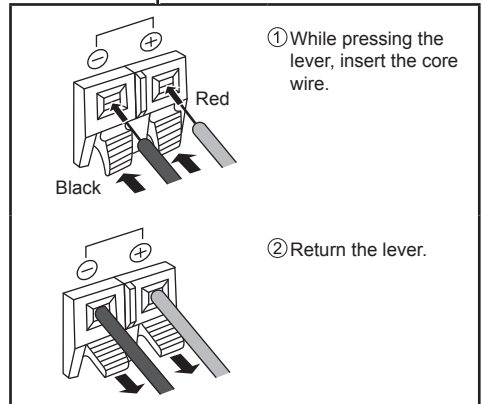
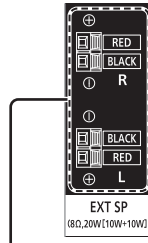

# Identifying Controls

## Main Unit

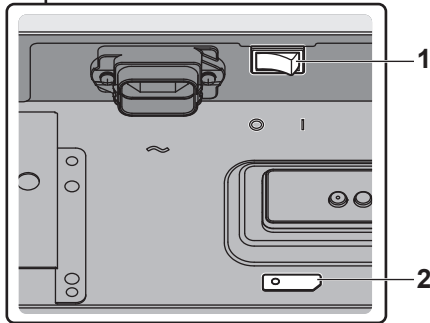
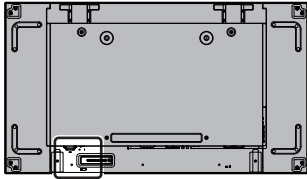

### 1 Main power switch (O / I)

Switches the main power ON ( I ) / OFF ( O ).

- Turning ON/OFF the <Main power switch> is the same as plugging or unplugging the power plug. Switch the <Main power switch> ON ( I ), and then turn the power ON / OFF with the remote control or <Power button (Unit)>.

### 2 Power Indicator / Remote control sensor (Back of the unit)

The Power Indicator will light.

**When the power of the unit is ON (Main power switch: ON ( I ))**

- Picture is displayed: Green
- Power OFF (Standby) with remote control or <Power button (Unit)>: Red
  - When [Network control] is set to [On] : Orange  
About [Network control] settings, see page 70.
- Power OFF with "Power management" function : Orange  
About "Power management" function, see page 67.

**When the power of the unit is OFF (Main power switch: OFF ( O )): No light**

#### Note

- When the power indicator is orange, power consumption during standby is generally larger than that of when the power indicator is red.

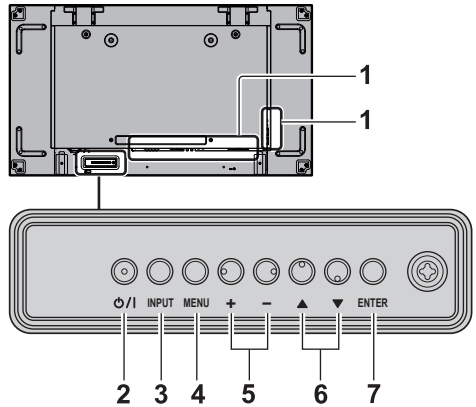

### 1 External Input Terminal

- Connects to video equipment, PC, etc. (see page 18)

### 2 <Power button (Unit)> (O/I)

- Turns the power ON (Picture is displayed.) / OFF (standby) when the <Main power switch> (O / I) is ON ( I ).

### 3 <INPUT (Unit)>

- Selects the connected device. (see page 35)

### 4 <MENU (Unit)>

- Displays the menu screen. (see page 40)

### 5 <+ (Unit)> / <- (Unit)>

- Adjusts the volume. (see page 36)
- On the main screen, switches settings or adjusts settings level. (see page 40)

### 6 <▲ (Unit)> / <▼ (Unit)>

- Selects the setting item on menu screen. (see page 40)

### 7 <ENTER (Unit)>

- Configures the item on menu screen. (see page 40)
- Switches aspect mode. (see page 38)

## Remote Control Transmitter

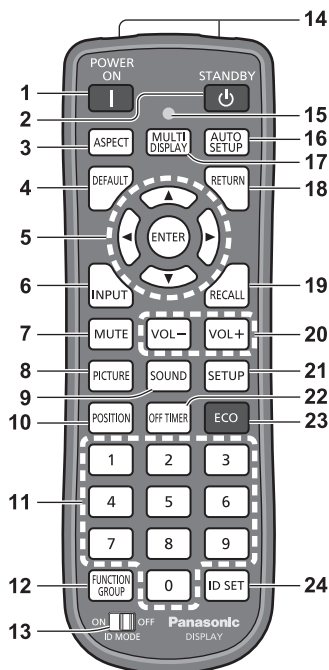

### 1 POWER ON ( I )

- Turns the power on (Picture is displayed.) when the <Main power switch> ( O / I ) is switched to on ( I ) and in Standby condition. (see page 33)

### 2 STANDBY ( O )

- Turns the power off (Standby condition) when the <Main power switch> ( O / I ) is switched to on ( I ) and the picture is displayed. (see page 33)

### 3 ASPECT

- Adjusts the aspect. (see page 38)

### 4 DEFAULT

- Resets the settings of picture, sound, etc., to defaults. (see page 42, 44, 45)

### 5 ENTER / Cursor buttons (▲▼◀▶)

- Used to operate the menu screens. (see page 40)

### 6 INPUT

- Switches input to display on the screen. (see page 35)

### 7 MUTE

- Sound mute on / off. (see page 36)

### 8 PICTURE

(see page 45)

### 9 SOUND

(see page 44)

### 10 POSITION

(see page 42)

### 11 Numeric buttons (0 - 9)

- Used to input ID number when using several Displays. (see page 111)
- Used as shortcut buttons by assigning frequently used operations. (see page 75)

### 12 FUNCTION GROUP

(see page 75)

### 13 ID MODE

(see page 111)

### 14 Signal emission

#### 15 Remote control operation Indicator

- Flashes when remote control buttons are pressed.

### 16 AUTO SETUP

- Automatically adjusts the position/size of the screen. (see page 42)

### 17 MULTI DISPLAY

- Switches [On] / [Off] in [Multi display setting]. (see page 58)

### 18 RETURN

- Used to return to the previous menu. (see page 40)

### 19 RECALL

- Displays the current setting status of Input mode, Aspect mode, etc. (see page 36)

### 20 VOL + / VOL -

- Adjusts sound volume level. (see page 36)

### 21 SETUP

(see page 51)

### 22 OFF TIMER

- Switches to stand-by after a fixed period. (see page 37)

### 23 ECO

- Switches the settings of [Power management mode]. (see page 67)

### 24 ID SET

- Used to set remote control ID number when using several Displays. (see page 111)

#### Note

- In this manual, buttons of the remote control and the unit are indicated as < >.

(Example: <INPUT>.)

The operation is mainly explained indicating the remote control buttons but you can also operate with the buttons on the unit when there are the same buttons.



# Basic Controls

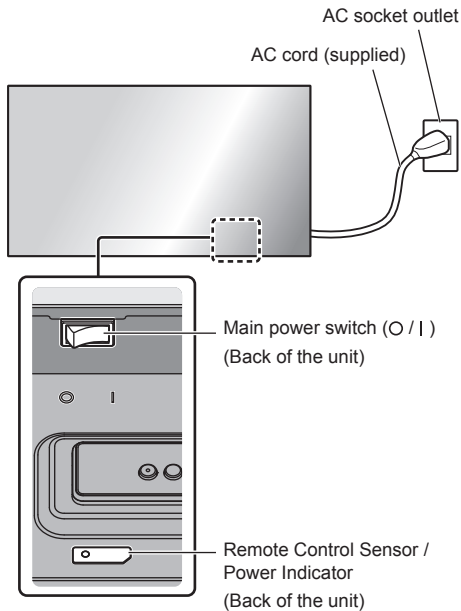

Operate pointing the remote control directly at the unit's Remote Control Sensor.



## Note

- Do not put an obstacle between the remote control sensor of the main unit and the remote control.
- Do not subject the remote control sensor of the main unit to the direct sunlight or strong fluorescent light.

## 1 Connect the AC cord plug to the Display.

(see page 17)

## 2 Connect the plug to the socket outlet.

### Note

- Main plug types vary between countries. The power plug shown at left may, therefore, not be the type fitted to your set.
- When disconnecting the AC cord, be absolutely sure to disconnect the AC cord plug at the socket outlet first.
- The settings may not be saved if the power plug is disconnected or the display is turned off at the <Main power switch> immediately after changing settings with on-screen menu. Leave enough period of time before disconnecting the power plug or switching the display off at the <Main power switch>. Or, turn the power off with the remote control, RS-232C control or LAN control before disconnecting the power plug or switching the display off at the <Main power switch>.

## 3 Switch the <Main power switch> (O / I) ON (I).

### ■ To turn the power ON/OFF with the remote control or <Power button (Unit)>:

#### To turn the power ON

The picture is displayed by pressing <POWER ON> or <Power button (Unit)> when the <Main power switch> is ON (I) (Power Indicator: Red or orange).

- Power Indicator: Green (Picture is displayed.)

#### To turn the power OFF

The power is turned OFF (Standby) by pressing <STANDBY> or <Power button (Unit)> when the <Main power switch> is ON (I) (Power Indicator: Green).

- Power Indicator: Red or orange (standby)

When the power is ON (Picture is displayed.) or OFF (standby), the power of the display is turned OFF by switching the <Main power switch> OFF (O).

### Note

- During operation of the "Power management" function (see page 67), the power indicator turns orange in the power off state.

## ■ When the Unit is turned on for the first time

Following screen will be displayed.

### 1 Select the language with ▲ ▼ and press <ENTER>.



### 2 For vertical installation, select [Portrait] with ▲ ▼ and press <ENTER>.

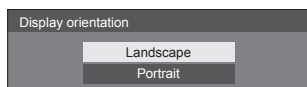

### 3 Select [Long life mode] with ▲ ▼ and set with ◀ ▶.

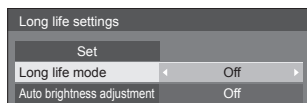

### 4 Select [Auto brightness adjustment] with ▲ ▼ and set with ◀ ▶.

### 5 Select [Set] with ▲ ▼ and press <ENTER>.

#### Note

- Once the items are set, the screens won't be displayed when switching on the unit next time. Each item can be reset in the following menus.  
[OSD language] (see page 69)  
[Display orientation] (see page 77)  
[Long life settings] (see page 79)

## ■ Power ON message

The following message may be displayed when turning the unit power ON:

### No activity power off Precautions

'No activity power off' is enabled.

When [No activity power off] in the [Setup] menu is set to [Enable], a warning message is displayed every time the power is turned ON. (see page 68)

### "Power management" Information

Last turn off due to 'Power management'.

When "Power management" is functioned, an information message is displayed every time the power is turned ON. (see page 67)

These message displays can be set with the following menu:

- [Options] menu
  - Power on message(No activity power off) (see page 81)
  - Power on message(Power management) (see page 82)

## Selecting the input signal

Select the signals input to the unit.

Press <INPUT> or <INPUT (Unit)>.

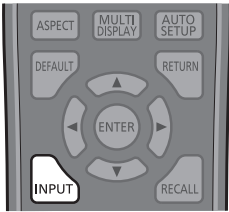

Unit

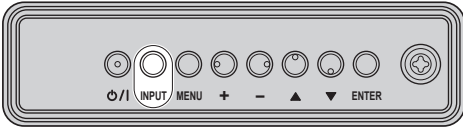

Switches input every time the buttons are pressed.

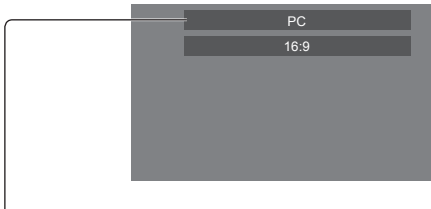

[HDMI] → [DisplayPort] → [DIGITAL LINK] → [DVI-D1]  
→ [DVI-D2] → [PC] → [COMPONENT]\* → [VIDEO] →  
[USB]

[HDMI]:

HDMI terminal, HDMI input

[DisplayPort]:

DisplayPort terminal, DisplayPort input

[DIGITAL LINK]:

DIGITAL LINK terminal, DIGITAL LINK input

[DVI-D1]:

DVI-D IN 1 terminal, DVI-D input

[DVI-D2]:

DVI-D IN 2 terminal, DVI-D input

[PC]:

PC IN terminal, PC input

[COMPONENT]\*:

COMPONENT/RGB IN terminal, Component input

[VIDEO]:

VIDEO terminal, composite video input

[USB]:

USB terminal, USB input

\*: [COMPONENT] may be displayed as [RGB] depending on the settings of [Component/RGB-in select]. (see page 52)

### Note

- Displays the signal name as set in [Input label]. (see page 66)
- Input will not be switched unless [Input lock] is set to [Off]. (see page 80)
- Image retention (image lag) may occur on the liquid crystal panel when a still picture is kept on the panel for an extended period. To prevent such a problem, using the screensaver and wobbling is recommended. (see page 65, 68)

## RECALL

It is possible to check the setting status of input label, picture mode, etc.

Press **<RECALL>**.

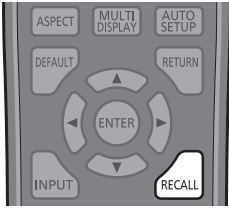

Current setting status will be displayed.

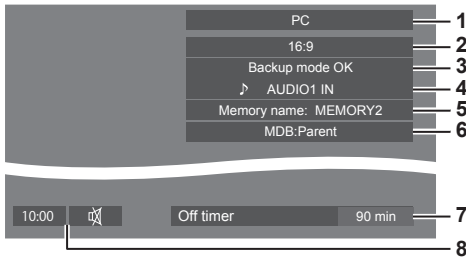

- 1 Input label
  - 2 Aspect mode (see page 38)
  - 3 Backup input change (see page 61, 63)
  - 4 Audio input (see page 79)
  - 5 Profile name (see page 49)
  - 6 Multi dynamic backlight (see page 54)
  - 7 Off timer remaining time (see page 37)
  - 8 Clock / Mute (see page 36)
- When there is no video signal to the selected input, [No signal] is displayed for about 30 seconds at the end.
  - When a USB memory is not connected to the USB terminal at the time of using the USB input, [No external media] is displayed for about 30 seconds. Even when a USB memory is connected, if it does not contain any playable file, [No play file] is displayed at all times.
  - To display the clock, set [Date and time], and then set [Clock display] to [On]. (see page 70, 81)

## Volume Adjustment

Press **<VOL +>** **<VOL ->** or **<+ (Unit)>** **<- (Unit)>** to adjust volume.

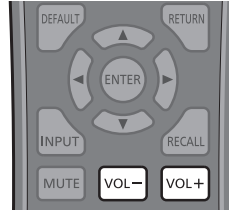

Unit

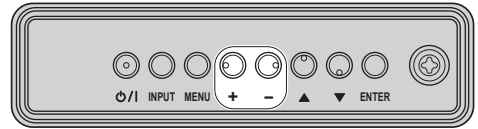

- The current sound volume level is memorised even if the power is turned off.
- When [Maximum VOL level] is set to [On], the volume can only be adjusted to the maximum point you set, and the displayed value turns red when it reached its maximum. (see page 80)
- When [Initial VOL level] is set to [On], the volume will be at the set level when the display is turned on. (see page 80)

## Sound mute On / Off

It is useful when you want to mute the sound temporarily, for example, when answering the phone or door.

Press **<MUTE>**.

- [Mute icon] appears on the screen and the sound is muted. Press again to reactivate the sound.



- It is also reactivated when the power is turned on / off or the volume level is changed.
- While MUTE is active, [Mute icon] is displayed as a reminder after operation.
- In [ENGLISH(US)] OSD language, [Mute icon] is displayed as [MUTE].

## OFF TIMER

The Display can be preset to switch to stand-by after a fixed period. (30 min, 60 min, 90 min)

**The setting switches each time <OFF TIMER> is pressed.**

- [0 min] → [30 min] → [60 min] → [90 min]  
→ [0 min] (Cancel)



- When three minutes remain, the remaining time will flash (Red). After that, it switches to stand-by.
- To see the Off timer remaining time, press <RECALL>.
- The Off timer is cancelled if a power interruption occurs. When the power is turned on later on, it will be in stand-by condition.

# ASPECT Controls

Press <ASPECT> or <ENTER (Unit)> repeatedly to move through the aspect options:

[4:3] → [Zoom1] → [Zoom2] → [16:9]



Unit

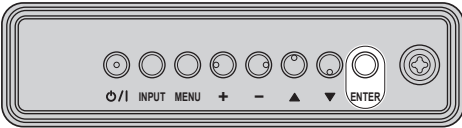

### Note

- The aspect mode is memorised separately for each input terminal.
- When input from USB, the aspect mode is fixed to [16:9].

### List of Aspect Modes

Aspect mode	Description
16:9	<p><b>Picture</b> → <b>Enlarged screen</b></p> <p>Pictures are displayed filling the screen.</p>

Aspect mode	Description
4:3	<p>Pictures are displayed in the 4:3 area. Pictures with a 4:3 aspect ratio are displayed as is. PC signals are enlarged or reduced to be displayed in the 4:3 area. Side panels are displayed both at the right and left edges of the screen.</p>
	<p>Pictures with a 4:3 aspect ratio in 16:9 signals are displayed with their original aspect ratio. The left and right edges of the pictures are masked by side panels.</p>
Zoom1	<p>Letterboxed pictures with a 16:9 aspect ratio are enlarged vertically to fill the screen. The top and bottom edges of the pictures are cut off.</p>
Zoom2	<p>Letterboxed pictures with a 16:9 aspect ratio are enlarged vertically and horizontally to fill the screen. The top and bottom edges as well as the left and right edges of the pictures are cut off.</p>

### Note

- Be aware that if you put the display in a public place for commercial purposes or a public showing and then use the aspect mode select function to shrink or expand the picture, you may be violating the copyright under copyright law. It is prohibited to show or alter the copyrighted materials of other people for commercial purposes without the prior permission of the copyright holder.
- In [ENGLISH(US)] OSD language, [16:9] is displayed as [FULL].

# Digital ZOOM

Select the screen areas (25 areas) to zoom in, and zoom in the selected image areas  $\times 2$ ,  $\times 3$  or  $\times 4$ .

(Use the remote control. The main unit's buttons cannot be used for operation.)

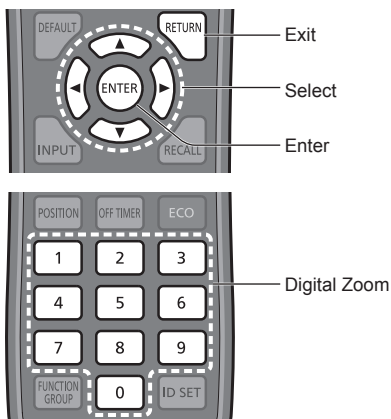

## Note

- To use the digital zoom function, assign [Digital zoom] to the numeric button of the remote control in [Function button settings] - [Shortcut]. (see page 74)

## 1 Set the digital zoom mode.

Press the numeric button out of <0> to <9> that you have assigned [Digital zoom].

- Use the button you have set to [Digital zoom] in [Function button settings] - [Shortcut].

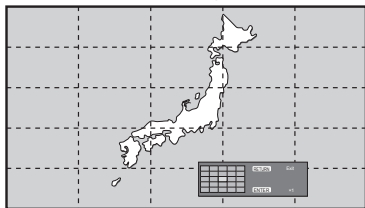

The screen aspect is set to [16:9], and the digital zoom operation guide is displayed.

## 2 Select the image areas to zoom in.

Select pressing  $\blacktriangledown$   $\blacktriangle$   $\blacktriangleleft$   $\blacktriangleright$ .

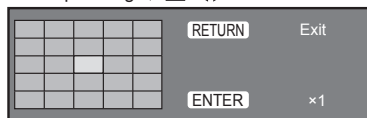

Digital Zoom operation guide

## 3 Switch the zoom ratio for the screen areas.

Switches every time <ENTER> is pressed.

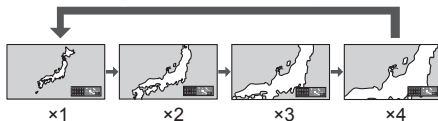

- If no operation is performed for approx. 60 seconds when the zoom ratio for the screen is " $\times 1$ ", the unit exits the zoom mode.
- If no operation is performed for approx. 3 seconds when the zoom ratio for the screen is " $\times 2$ ", " $\times 3$ " or " $\times 4$ ", the digital zoom operation guide display disappears. Pressing any of the  $\blacktriangledown$   $\blacktriangle$   $\blacktriangleleft$   $\blacktriangleright$  buttons displays the guide again.

## 4 Exit the digital zoom mode.

Press <RETURN> to exit the mode.

The screen returns to the previous state just before entering the digital zoom mode, and the digital zoom operation guide display disappears.

- Press any of the following buttons to exit the mode. Then, the operation of the pressed button is performed.

Remote Control:

<AUTO SETUP> <POSITION> <PICTURE>  
<INPUT> <SETUP> <SOUND> <DEFAULT>  
<RECALL> <MUTE> <ASPECT> <OFF  
TIMER> <FUNCTION GROUP> <MULTI  
DISPLAY> <ECO> <VOL +> <VOL ->  
<0> - <9>

Unit:

<INPUT (Unit)> <MENU (Unit)> <+ (Unit)>  
<- (Unit)>  $\blacktriangle$   $\blacktriangledown$  <ENTER (Unit)>

- When the screen saver timer starts up, the digital zoom mode finishes.
- When the power is turned OFF, a force-quit is performed.
  - When the power is turned OFF by pressing <STANDBY> or <Power button (Unit)>
  - When the power is turned OFF by the off-timer
  - When the power is turned OFF by [No signal power off] or [Power management].

## Note

- In the following cases, the digital zoom mode is not available.
  - When [Multi display setting] is [On]
  - When the screen saver is in operation
  - When USB input is selected.
- The zoomed image is rougher than the original image.
- For multi display use, use the functions in [Multi display settings]. (see page 58)

# On-Screen Menu Displays

## 1 Display the menu screen.

Remote Control

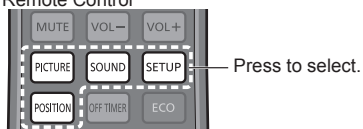

Unit



Each time the button is pressed, the menu screen will switch.

Normal Viewing → [Picture] → [Setup] → [Position] → [Sound]

## 2 Select the item.

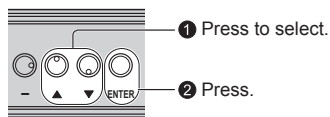
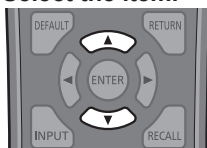

(Example: [Picture] menu)

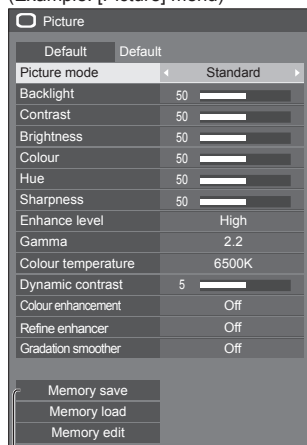

Submenu

Press <ENTER> to display the submenu.

## 3 Set.

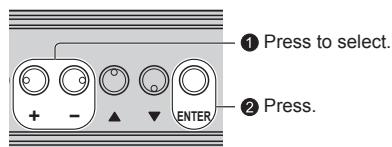

## 4 Exit from the menu.

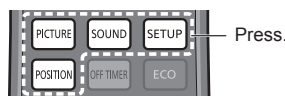

Press <RETURN> to return to the previous screen.

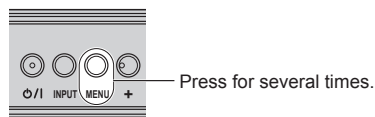

### Note

- When changing the settings of the display, picture or sound disturbance may occur temporarily. This is not a malfunction.



## Menu display list

- Menu that cannot be adjusted is greyed out.  
Adjustable menu changes depending on signal, input and menu setting.

## [Position] menu

(see page 42 - 43)

Position	
Default	Default
Auto setup	
H-position	0
H-size	0
V-position	0
V-size	0
Clock phase	15
Dot clock	0
1:1 pixel mode	Off

## [Sound] menu

(see page 44)

Sound	
Default	Default
Output select	Speaker out
Balance	0
Sound mode	Normal
Bass	0
Treble	0
Surround	Off

## [Picture] menu

(see page 45 - 50)

Picture	
Default	Default
Picture mode	Standard
Backlight	50
Contrast	50
Brightness	50
Colour	50
Hue	50
Sharpness	50
Enhance level	High
Gamma	2.2
Colour temperature	6500K
Dynamic contrast	5
Colour enhancement	Off
Refine enhancer	Off
Gradation smoother	Off
Memory save	
Memory load	
Memory edit	

## [Setup] menu

(see page 51 - 77)

Setup 1/2	
Signal	
Control settings	
Multi display settings	
Input search	
Failover/Failback	
Colour matching function	
Screensaver	
Input label	
Power management settings	
Wobbling	Off
DIGITAL LINK out	Monitor out(Digital)
No activity power off	Disable
Power ON screen delay	Off
OSD language	English(UK)

Setup 2/2	
Set up timer	
Date and time	
Network settings	
USB media player settings	
Function button settings	
Startup image settings	
Display orientation	Landscape
OSD position	Right
Menu display duration	60 sec
Menu transparency	20

# Adjusting Position

## 1 Press <POSITION> to display the [Position] menu.

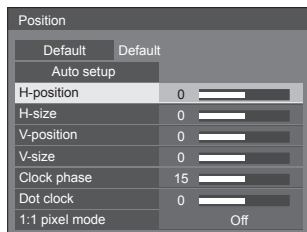

## 2 Select the item to adjust with ▲ ▼.

- Unadjustable items are greyed out.

Adjustable items differ depending on the signal, input and the display mode.

## 3 Adjust with ◀▶.

## 4 Press <POSITION> to exit from adjust mode.

### ■ To return to the previous screen

Press <RETURN>.

### ■ To reset to defaults

When [Default] is selected, pressing <ENTER> resets the adjustment values of all the displayed menus to default.

When adjusting each item, pressing <DEFAULT> resets the adjustment value of the item to default.

#### Note

- Settings for [Position] are memorised separately for each input signal.

### Setting [Position] when the display is installed vertically

When adjusting, please note that even when the display is installed vertically, setting directions of position / size are the same as that of horizontal installation.

## Auto setup

When inputting a PC signal, [H-position] / [V-position], [H-size] / [V-size], [Clock phase] and [Dot clock] are automatically corrected.

**This setting is enabled under the following condition:**

- When inputting from PC IN or RGB IN

**While displaying the picture of the corresponding signal, select [Auto setup] and press <ENTER>.**

### Using Remote Control

**Press <AUTO SETUP>.**

When Auto Setup does not work, [Invalid] is displayed.

### Auto mode

When the [PC auto setting] is set to [On] in the [Options] menu (see page 81), automatic position adjustment starts under the following conditions:

- When the display power is turned On.
- When the input signal is switched.

#### Note

- When the dot clock frequency of a PC signal is 162 MHz or higher, [Clock phase] and [Dot clock] cannot be automatically corrected.
- Auto Setup may not work when a cropped or dark image is input. In such case, switch to a bright image with borders and other objects are clearly shown, and then try auto setup again.
- Depending on the signal, out of alignment may occur after Auto Setup. Carry out fine tuning for the position/size as required.
- If Auto Setup cannot set properly for XGA signal (1024×768, 1280×768, 1366×768), pre-selecting the individual signal in [XGA mode] (see page 53) may result in correct Auto Setup.
- Accurate auto setup is not possible when a signal such as additional information is superimposed out of valid image period or when intervals between synchronizing signal and image signal are short. Also, accurate auto setup is not possible when image signals with tri level synchronizing signal added, or when some SYNC ON G signals are input.
- If Auto Setup does not work well, select [Default], press <ENTER>, and then adjust the position/size manually.

**[H-position]** Adjust the horizontal position with ◀▶.

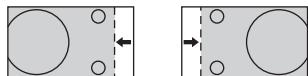

**[H-size]** Adjust the horizontal size with ◀▶.

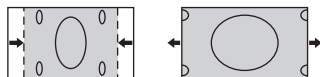

**[V-position]** Adjust the vertical position with ▲▼.

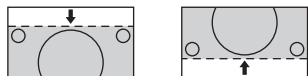

**[V-size]** Adjust the vertical size with ▲▼.

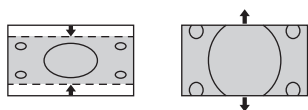

**[Clock phase]** (For RGB IN or PC IN input)

In some cases, frame of the screen appears blurred or smudged, when RGB signal or PC signal are input.

**[Dot clock]** (For RGB IN or PC IN input)

Periodic striped pattern interference (noise) may occur when a striped pattern is displayed. If this happens, adjust so that any such noise is minimized.

**[Over scan]** Turn image over scan On/Off.

**Applicable input signal:**

525i, 525p, 625i, 625p, 750/60p, 750/50p  
(Component Video, RGB, DVI-D, HDMI, DisplayPort, DIGITAL LINK)

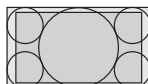

[On]



[Off]

**Note**

- When [Off] is set, [H-size] and [V-size] cannot be adjusted.

**[1:1 pixel mode]** Adjusts the display size when 1125i or 1125p signal is input.



[Off]



[On]

**Applicable input signal:**

1125 / 50i, 60i, 24PsF, 24p, 25p, 30p, 50p, 60p

**Note**

- Select [Off] when flickering is shown around the image.
- [H-size] and [V-size] cannot be adjusted when [On] is selected.

**Note**

- In some cases, noise appears outside the area picture is displayed, but it is not a malfunction.

# Sound Adjustment

## 1 Press <SOUND> to display the [Sound] menu.

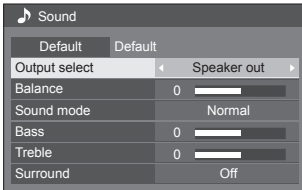

## 2 Select the item to adjust with ▲ ▼.

- Menu that cannot be adjusted is greyed out.

## 3 Adjust with ◀ ▶.

## 4 Press <SOUND> to exit from adjust mode.

### ■ To return to the previous screen

Press <RETURN>.

### ■ To reset to defaults

Press <DEFAULT> while the menu is displayed, or press <ENTER> when [Default] is selected, then the adjustment values of all the displayed menus are reset to default.

**[Output select]** Select the audio output.

#### **[Speaker out]:**

External speakers

#### **[AUDIO OUT]:**

AUDIO OUT terminal output

- When [AUDIO OUT] is selected, the other menus are greyed out and cannot be selected.
- Audio volume setting is memorized separately for each output.

**[Balance]** Adjusts left and right volumes.

**[Sound mode]** Select for best audio.

#### **[Normal]:**

Emits the original sound.

#### **[Dynamic]:**

Accentuates sharp sound.

#### **[Clear]:**

Attenuates human voice.

- In [ENGLISH(US)] OSD language, [Sound mode] and [Normal] are displayed as [AUDIO MENU] and [STANDARD].

**[Bass]**

Adjusts low pitch sounds.

**[Treble]**

Adjusts high pitch sounds.

**[Surround]**

**[Off]:**

Normal sound

**[On]:**

Surround sound

### Note

- [Bass], [Treble] and [Surround] settings are memorised separately for [Normal], [Dynamic] and [Clear] in [Sound mode].

# Picture Adjustments

## 1 Press <PICTURE> to display the [Picture] menu.

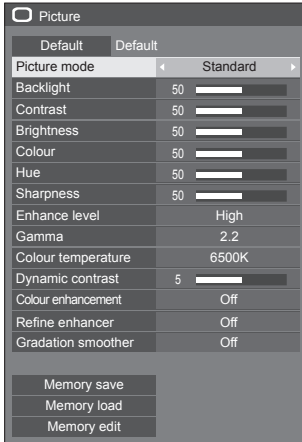

## 2 Select the item to adjust with ▲ ▼.

- Menu that cannot be adjusted is greyed out.

## 3 Adjust with ◀ ▶.

## 4 Press <PICTURE> to exit from adjust mode.

### ■ To return to the previous screen

Press <RETURN>.

### ■ To reset to defaults

When [Default] is selected, pressing <ENTER> resets the adjustment values of all the displayed menus to default.

When adjusting each item, pressing <DEFAULT> resets the adjustment value of the item to default.

#### Note

- When displaying still picture with USB input (USB media player), only the following settings have an effect on the picture.

[Backlight], [Gamma], [Colour temperature]

### [Picture mode]

This menu switches to easy-to-see pictures suitable to the picture source or environment where this unit is used.

#### [Vivid signage]

Suitable for signage applications featuring more vivid and sharper images in bright environments such as a shop.

#### [Natural signage]

Suitable for signage applications such as merchandise exhibition, featuring natural tone images with colour reproduction emphasized under light.

#### [Standard]

Faithfully reproduces original picture.

#### [Surveillance]

Tone-focused pictures with brightness reduced suitable for input from a monitoring camera.

#### [Graphic]

Suitable for PC input.

#### [DICOM]

Pictures close to the grayscale standard DICOM Part14.

- The settings are memorised separately for each input terminal.

- In [ENGLISH(US)] OSD language, the [Picture mode] is displayed as [PICTURE MENU].

#### Note

- DICOM is the abbreviation for "Digital Imaging and Communications in Medicine", which is a standard for communications between medical imaging devices. Although "DICOM" is used as a picture mode name, this unit is not a medical device. Do not use displayed images for such purposes as diagnosis.

### [Backlight]

Adjusts luminance of the back light.

**Darker ↔ Brighter**

### [Contrast]

Selects the proper brightness and density for the room.

**Less ↔ More**

- In [ENGLISH(US)] OSD language, [Contrast] is displayed as [PICTURE].

**[Brightness]** Adjusts for easier viewing of dark pictures.

**Darker ↔ Brighter**

**[Colour]** Adjusts colour saturation.

**Less ↔ More**

**[Hue]** Adjusts hue of skin colour.

**Reddish ↔ Greenish**

- In [ENGLISH(US)] OSD language, [Hue] is displayed as [TINT].

**[Sharpness]** Adjusts picture sharpness.

**Less ↔ More**

**[Enhance level]** Switches the effect range for sharpness.

**[High]:**

Large effect

**[Low]:**

Small effect

**[Gamma]** Adjusts gamma.

**[2.0], [2.2], [2.4], [2.6],**

**[DICOM]:**

Small tilt - Large tilt

**Note**

- When [DICOM] is selected in [Picture mode], [Gamma] is fixed to [DICOM].  
When the items other than [DICOM] are selected in [Picture mode], [DICOM] cannot be set for [Gamma].

**[Colour temperature]** Adjusts colour tone.

**[3200K], [4000K], [5000K], [6500K], [7500K], [9300K], [10700K], [Native], [USER1], [USER2]**

**Note**

- Emphasizes red when the numerical value of [Colour temperature] is small, and emphasizes blue when it is big.
- [Native] is a colour tone of the panel element. When this is selected, [Gamma] is fixed to 2.2 or equivalent and it cannot be adjusted.
- When [DICOM] is selected in [Picture mode], only [6500K] and [9300K] can be selected.

**User setting of [Colour temperature]**

2 kinds of detailed [Colour temperature] settings ([USER1] and [USER2]) can be stored.

1 Press <ENTER> while setting [Colour temperature].

Enhance level	High
Gamma	2.2
Colour temperature	6500K

Example:

When [Colour temperature] is [6500K], it is possible to reflect the set point, [6500K], to the set point of [USER1] and [USER2].

2 Select the user to memorise settings with ▲▼ and press <ENTER>.

Adjust colour temperature	
Change to 6500K	
USER1	
USER2	

3 Select [Yes] with ◀▶ and press <ENTER>.

Adjust colour temperature	
Overwrite colour temperature "USER1"?	
Yes	No

4 Set each item on detail settings screen.

Adjust colour temperature	
USER1	
R gain	255
G gain	150
B gain	64
R bias	0
G bias	0
B bias	0

**[R gain]**

Adjusts the white balance for light red areas.

**0 to 255**

**[G gain]**

Adjusts the white balance for light green areas.

**0 to 255**

**[B gain]**

Adjusts the white balance for light blue areas.

**0 to 255**

**[R bias]**

Adjusts the white balance for dark red areas.

**-127 to 128**

### [G bias]

Adjusts the white balance for dark green areas.

-127 to 128

### [B bias]

Adjusts the white balance for dark blue areas.

-127 to 128

The settings are saved for the user. When you return to [Picture] menu, the user you have set is selected for [Colour temperature].

Enhance level	High
Gamma	2.2
Colour temperature	USER1

### [Dynamic contrast]

Automatically adjusts the contrast by determining the changes in the use of colours for images that constantly change, such as motion pictures.

**No effect ↔ Large effect**

### [Colour enhancement]

Displays images by emphasising colours.

**[Off], [Low], [Mid], [High]**

(Small effect to Large effect)

### [Refine enhancer]

Enhances the sense of resolution by correcting fuzzy outlines of pictures resulted from resizing, etc.

**[Off], [Low], [Mid], [High]**

(Small effect to Large effect)

### [Gradation smoother]

Extracts and eliminates noise components from the input video signals, and then displays noiseless pictures.

**[Off], [On]**

# Picture Profiles

Up to 8 combinations of picture adjustment values (in the [Picture] menu) can be stored in the display memory as profiles and applied as needed, for a convenient way to enjoy your preferred picture settings.



### [Memory save]

(see page 48)

### [Memory load]

(see page 49)

### [Memory edit]

(see page 50)

1. [ ]	MEMORY1
2. [*]	MEMORY2
3. [*]	MEMORY3
4. [ ]	MEMORY4
5. [ ]	MEMORY5
6. [ ]	MEMORY6
7. [ ]	MEMORY7
8. [ ]	MEMORY8

## Overview of Picture Profiles

### Original picture



Adjust picture.  
(see page 45 - 47)



### Custom picture



Example:  
Save the picture adjustment values in the [MEMORY1] profile.  
**[Memory save]**

### Original picture



Example:  
Load [MEMORY1].  
**[Memory load]**



### Custom picture



### [Memory edit] screen

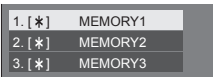

Example:  
Change the memory name to [MY PICTURE].  
**[Memory edit]**



## Saving profiles

Follow these steps to save picture adjustment values as profiles.

- 1 Specify the picture quality in the [Picture] menu.  
(see page 45 - 47)
- 2 In the [Picture] menu, select [Memory save] with ▲ ▼ and press <ENTER>.

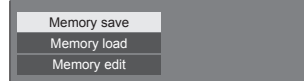

- 3 Select a profile name for saving the picture adjustment values with ▲ ▼ and press <ENTER>.

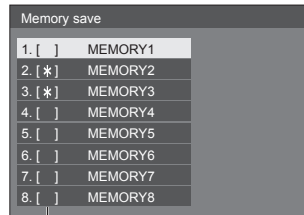

- [\*] appears for a profile in which the picture adjustments have already been saved.

- 4 Select [Ok] with ◀ ▶ and press <ENTER>.

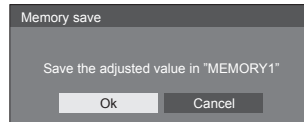

- 5 Enter a profile name with ▲ ▼ ◀ ▶.

- Entering characters (see page 112)





- 6** When you finished entering the profile name, select [Ok] with ▲▼◀▶ and press <ENTER>.

- To cancel saving the profile, select [Cancel].

## Loading profiles

Load profiles and apply the picture adjustment values to the display as follows.

- 1** In the [Picture] menu, select [Memory load] with ▲▼ and press <ENTER>.

- 2** Select the profile to load with ▲▼ and press <ENTER>.

**Loading profiles using numeric buttons on the remote control.**

Each numeric button <1> - <8> is allocated for loading [MEMORY1] to [MEMORY8].

[Function button settings] (see page 74)

- 1** Press any of <1> - <8>.
- 2** Select [Ok] with ◀▶ and press <ENTER>.

When profile is being loaded, profile name is displayed.

### Note

- Loaded profiles are stored in memory according to the selected input terminal.

## Editing profiles

Delete or rename profiles as follows.

### ■ Deleting profiles

- 1 In the [Picture] menu, select [Memory edit] with ▲ ▼ and press <ENTER>.

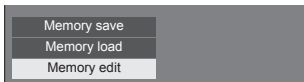

- 2 Select [Memory delete] with ▲ ▼ and press <ENTER>.

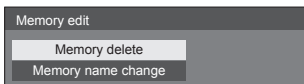

- 3 Select the profile to delete with ▲ ▼ and press <ENTER>.

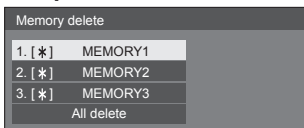

- To delete all profiles, select [All delete].

- 4 Select [Ok] with ◀▶ and press <ENTER>.

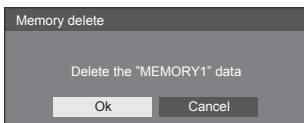

### ■ Renaming profiles

- 1 In the [Picture] menu, select [Memory edit] with ▲ ▼ and press <ENTER>.

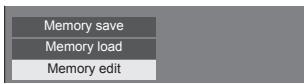

- 2 Select [Memory name change] with ▲ ▼ and press <ENTER>.

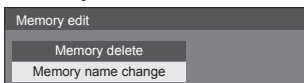

- 3 Select the profile to rename with ▲ ▼ and press <ENTER>.

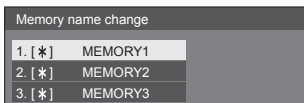

- 4 Enter a name for the profile with ▲ ▼ ◀▶.

- Entering characters (see page 112)



- 5 When you finished entering the profile name, select [Ok] with ▲ ▼ ◀▶ and press <ENTER>.



- To cancel renaming the profile, select [Cancel].

# Setup menu

## 1 Press <SETUP> to display the [Setup] menu.

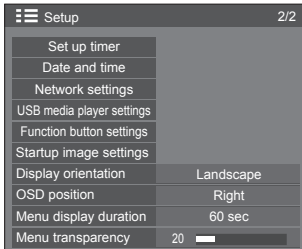
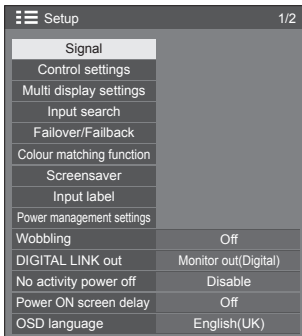

## 2 Select the item to set with ▲ ▼.

- Menu that cannot be adjusted is greyed out. Adjustable menu changes depending on signal, input and menu setting.

## 3 Set with ◀ ▶.

## 4 Press <SETUP> to exit from adjust mode.

### ■ To return to the previous screen

Press <RETURN>.

## Signal

Examples of [Signal] submenu screen

When HDMI / DVI / DisplayPort / DIGITAL LINK is selected

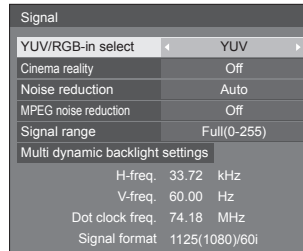

When COMPONENT / RGB is selected

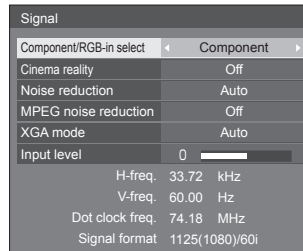

When PC is selected

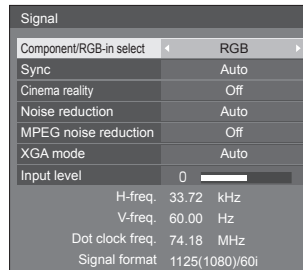

When VIDEO is selected

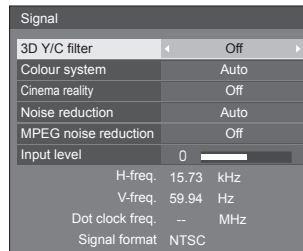

When USB is selected



**Note**

- [Signal] setup menu displays a different setting condition for each input signal.
- Menu that cannot be adjusted is greyed out.

■ **[Component/RGB-in select]**

This menu is displayed at PC IN and COMPONENT/RGB IN inputs.

Select to match the signals from the source connected to each terminal.

**[Component]** YPbPr/YCbCr signals

**[RGB]** RGB signals

**Note**

- Set for each input terminal (COMPONENT/RGB IN, PC IN).

■ **[YUV/RGB-in select]**

This menu is displayed at HDMI, DisplayPort, DIGITAL LINK, DVI-D IN 1 and DVI-D IN 2 inputs.

Select to match the signals from the source connected to each terminal.

**[YUV]** YUV signals

**[RGB]** RGB signals

**Note**

- Set for each input terminal (HDMI, DisplayPort, DIGITAL LINK, DVI-D IN 1, DVI-D IN 2).

■ **[Sync]**

This menu is displayed at PC IN input.

**Setting RGB/PC sync signal**

**[Auto]:**

The H and V sync or synchronized signal is automatically selected. When both of them have sync signal, H and V sync will be selected.

When displaying CS signal, connect to HD input terminal.

**[on G]:**

Uses a synchronized signal on the Video G signal, which is input from the G connector.

**[HV sync]:**

Uses a synchronized signal on the Video HD/VD signal, which is input from the HD/VD connector.

**Setting Component sync signal**

**[Auto]:**

The H and V sync or synchronized signal is automatically selected. When both of them have sync signal, H and V sync will be selected.

When displaying CS signal, connect to HD input terminal.

**[on Y]:**

Uses a synchronized signal on the Video Y signal, which is input from the Y connector.

**[HV sync]:**

Uses a synchronized signal on the Video HD/VD signal, which is input from the HD/VD connector.

■ **[Cinema reality]**

Faithfully reproduces videos shot with cinema films. Set this to [Off] normally.

**Note**

- In [ENGLISH(US)] OSD language, [Cinema reality] is displayed as [3:2 PULLDOWN].
- If [Cinema reality] is set to [On], videos including movies shot at 24 frames per second are reproduced more naturally.
- If the video is unnatural with [On] set, set it to [Off].

■ **[Noise reduction]**

Reduces picture noise.

**[Off]:**

Disables Noise Reduction.

**[Min], [Mid], [Max]:**

Sets strength of Noise Reduction.

**[Auto]:**

Noise reduction will be automatically selected from [Min], [Mid] or [Max].

### ■ [MPEG noise reduction]

Reduces block noise and mosquito noise on MPEG videos.

#### [Off]:

Disables Noise Reduction.

#### [Min], [Mid], [Max]:

Sets strength of Noise Reduction.

### ■ [XGA mode]

This menu is displayed at PC IN and COMPONENT/RGB IN inputs.

This unit supports XGA signals (1024 × 768, 1280 × 768, 1366 × 768) having different aspect ratios and sampling rates.

#### [Auto]:

Automatically detects the signal.

Switch the setting to suit the input signal for better display depends on the angle of view or display resolution condition.

#### Note

- After making this setting, be sure to make each adjustment (such as [Auto setup]) on the [Position] menu as necessary. (see page 42)

### ■ [Signal range]

This menu is displayed at HDMI, DisplayPort, DIGITAL LINK, DVI-D IN 1 and DVI-D IN 2 inputs. Switches the dynamic range to match the signals from the source connected to each terminal.

#### [Video(16-235)]:

If the input signal is the video range

Example: HDMI terminal output for DVD player

#### [Full(0-255)]:

If the input signal is full range

Example: HDMI terminal output for personal computer

#### [Auto]:

Switches the dynamic range automatically between [Video(16-235)] and [Full(0-255)] according to the input signal.

#### Note

- [Auto] can be selected at HDMI, DisplayPort and DIGITAL LINK signal inputs.

### ■ [Input level]

This menu is displayed at PC IN, COMPONENT/RGB IN and VIDEO IN inputs.

Adjustment of parts which are extremely bright and hard to see.

#### - 16 to + 16:

(Level low) - (Level high)

### ■ [3D Y/C filter]

Set this if the video looks unnatural at VIDEO IN input. Set this to [On] normally.

#### Note

- Depending on the signalling system, this setting may be less effective or may not be effective at all.

### ■ [Colour system]

Sets the colour system according to the signal method at VIDEO IN input. Set this to [Auto] normally. This automatically detects the input signal format.

#### [Auto], [PAL], [SECAM], [NTSC], [NTSC 4.43], [PAL M], [PAL N]:

Set this to [Auto] when viewing PAL-60 videos.

#### When images are unstable

When the system is set to [Auto], images become unstable in rare case under the condition that the input signals are at low level or have many noises. In this case, set the system so it conforms with the input signal format.

### ■ [Multi dynamic backlight settings]

This menu is displayed at HDMI, DisplayPort, DIGITAL LINK, DVI-D IN 1 and DVI-D IN 2 inputs.

Adjusts the backlight using LAN while interlocking all the main units that constitute multiple screens.

Black levels among multi-screen displays are equalized.

The settings are memorised separately for each input terminal.

[Multi dynamic backlight settings] - submenu screen

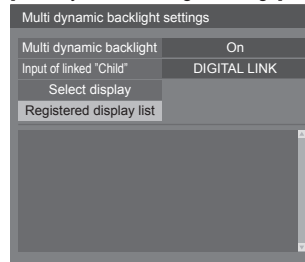

#### [Multi dynamic backlight]

**[On]:** This function is enabled, and the unit operates as a parent.

**[Auto]:** When the unit is registered as a child, this function is enabled.

#### [Input of linked "Child"]

The digital input terminal that operates on the child in conjunction with the parent can be selected. If the child receives images of input terminals other than the input terminal set on the parent, it does not operate.

### [Select display]

Select the child to operate in conjunction with the parent. The registration procedure is as follows.

- ① Set the input of the child to operate in conjunction with the current input of the parent.
- ② Select [Select display] and press <ENTER>.
- ③ When devices on the same network are listed, select the device to register, press <VOL +> to add an check mark, and press <ENTER>.
- ④ Set [Multi dynamic backlight] to [On].

### [Registered display list]

Displays the list of children registered to this unit.

The interlock status of each child can be checked.

The green mark on the list shows this function operates normally.

The red mark shows a display that is not operating. Check the LAN cable for connection, and review the power status and settings of the child. If the problem is not solved after review, the registration may have failed. Perform registration for [Select display] again.

#### Note

- When performing [Select display], turn on all the units constituting multiple screens.
- "Parent" is the unit of which [Multi dynamic backlight] is set to [On]. Operate the menu of [Multi dynamic backlight settings] of the parent to register children, etc.  
"Child" is the unit registered to the parent. The child can be confirmed on the registration display list of the setting menu of the parent.
- This function is operated regardless of the setting in [Network control] ([On] / [Off]). However, set IP address properly for all the main units that constitute multiple screens.
- This function operates among the units present on the same network (Class C setting: subnet mask [255.255.255.0]).
- Up to 31 units can be registered as children. Up to 32 units including the parent are interlocked.
- Multiple parents cannot select the same child. Before registering children, fully consider the combination of parent and child.
- Disconnecting the LAN cable during operation or turning off some of the units constituting multiple screens may cause this function to operate abnormally.
- Setting and operation are possible only with the digital input.
- If <RECALL> is pressed while performing this function, an indication to show whether the display is set to the parent or the child appears. [MDB] stands for [Multi dynamic backlight].

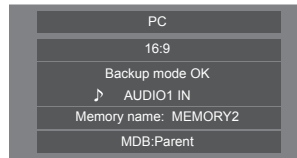

- While performing this function, the area control of backlight for each display is disabled.
- When displaying the [Multi dynamic backlight settings] sub menu screen on this unit that has been registered as a child, a message to ask whether to switch to the parent appears.  
If [Yes] is selected, the setting screen appears, and the operation is switched to that of parent.

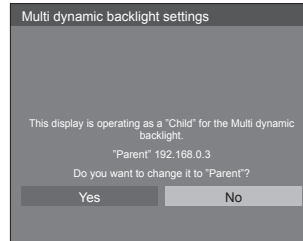

### ■ Input signal display

Displays the frequency and the type of the current input signal.

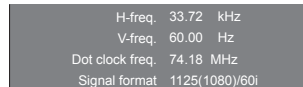

#### Display range:

Horizontal (15 kHz - 135 kHz)

Vertical (24 Hz - 120 Hz)

The dot clock frequency is displayed when Digital and PC signal are input.

## Control settings

Sets each item of the function which enables to control multiple displays at the same time, or individually.

[Control settings] - submenu screen

Control settings	
IR control	Built-in
IR out	IR OUT
Serial control	SERIAL IN
Serial out	SERIAL OUT
Display ID	0
Controller ID function	Off
Serial ID function	Off
Serial response (Normal)	On
Serial response (ID all)	Off
Serial ID group	A
Serial response (ID group)	Off
Serial daisy chain position	—
Multi control auto setting (DIGITAL LINK)	

### ■ [IR control]

Sets the terminal used for the IR signal input.

The terminal ([Built-in] / [IR IN] / [DIGITAL LINK]) which is currently selected is displayed on the [Control settings] submenu screen.

Select [IR control] with ▲ ▼ and press <ENTER>.

On the [IR control] submenu screen, select the terminal to use.



### [IR IN]:

Connecting an external IR receiver or IR cable to the IR IN terminal will switch to the remote-control operation via the IR IN terminal. The display is fixed to [IR IN].

Although the setting can be changed to something other than [IR IN] while using the IR IN terminal, the changed setting is invalid.

### [Auto]:

Only when connected to the unit via DIGITAL LINK, signals are received with the DIGITAL LINK IN terminal. For other connections, remote control signals are received with the remote control sensor of the unit.

### [Built-in]:

Remote control sensor of the unit

### [DIGITAL LINK]:

DIGITAL LINK IN terminal

### Note

- [IR IN] cannot be set manually.
- When [Auto] is set, the unit automatically detects the connection in power-on status. This setting does not respond to the connection change in standby mode.
- The changed setting is enabled when the [IR control] sub menu screen is exited.

### ■ [IR out]

Sets the terminal used for the IR signal output.

[IR OUT]: IR output terminal

[DIGITAL LINK]: DIGITAL LINK OUT terminal

### ■ [Serial control]

Sets the terminal used for the serial communication input.

[SERIAL IN]: Serial terminal

[DIGITAL LINK]: DIGITAL LINK IN terminal

### ■ [Serial out]

Sets the terminal used for the serial communication output.

[SERIAL OUT]: Serial output terminal

[DIGITAL LINK]: DIGITAL LINK OUT terminal

### ■ [Display ID]

Set ID number when controlling the Display with [Controller ID function] and [Serial ID function].

0 to 100 (Standard value: 0)

### ■ [Controller ID function]

Enables/disables the [Controller ID function].

#### [Off]:

Disables the [Controller ID function]. (Can be operated as normal remote control.)

#### [On]:

Enables the [Controller ID function]. Effective on switching to [On].

### Note

- To use the [Controller ID function], setting ID numbers both for the remote control and for the display unit is required.  
For ID number setting for the remote control, see page 111.
- About how to reset the settings to defaults: "Initialization" (see page 83)

### ■ [Serial ID function]

Set to control external control with the PC connected to SERIAL terminal according to the Display's ID number.

#### [Off]:

Disables external control by the ID.

#### [On]:

Enables the external control by the ID.

### ■ [Serial response (Normal)]

Sets whether to send the response command to normal commands without ID.

#### [Off]:

Does not respond. (Including the inquiry command)

#### [On]:

Responds.

### ■ [Serial response(ID all)]

Set whether to respond to the command or not, when serial command of ID number "0" is received.

#### [Off]:

Does not respond.

#### [On]:

Responds.

### ■ [Serial ID group]

When controlling multiple displays simultaneously via serial communication, those displays are grouped as one.

A to G (7 groups)

### ■ [Serial response(ID group)]

Sets whether to respond to the command or not, when serial command, which the group is specified, is received.

#### [Off]:

Does not respond.

#### [On]:

Responds.

### ■ [Serial daisy chain position]

Sets the first and the last terminals of the daisy chain connection when serial-controlling this unit by the daisy chain connection (including connection via the SERIAL IN/OUT terminal or via DIGITAL LINK, or mixed connection).

#### [---]:

When controlling this unit alone with serial control, or connecting at a position other than the first and last terminals in a daisy chain

#### [Top]:

When connecting at the first terminal in a daisy chain

#### [End]:

When connecting at the last terminal in a daisy chain

### ■ [Multi control auto setting(DIGITAL LINK)]

When connected with the DIGITAL LINK daisy chain, display IDs are automatically assigned to all the displays, and the serial IN/OUT terminals, remote control IN/OUT terminals and the network are automatically set.

- ① Select [Multi control auto setting(DIGITAL LINK)] with ▲ ▼ and press <ENTER>.

Multi control auto setting(DIGITAL LINK)		
Status	Wait	
DIGITAL LINK daisy chain	020/025	
Display ID	0	
Network control / IP address	Off	192.168.0.8
Serial ID / Terminal	On	SERIAL IN
Serial out terminal	SERIAL OUT	
Controller ID / Terminal	On	Built-in
Controller out terminal	IR OUT	
Start		
Display ID	1	
Changing network control	Yes	
Changing Serial/IR terminal	Yes	

The following screen is displayed on the subsequent-stage displays.

Multi control auto setting(DIGITAL LINK)		
Status	Wait	
DIGITAL LINK daisy chain	021/025	
Display ID	0	
Network control / IP address	Off	192.168.0.8

#### [Status]

Displays the execution state of the display ID auto setting.

#### [Wait]:

ID auto setting has not been executed yet.

#### [Finished]:

ID auto setting is completed.

#### [DIGITAL LINK daisy chain]

Displays the connection number counted from the first unit to this unit out of total displays connected via DIGITAL LINK.

#### [Display ID]

Displays the current display ID.

#### [Network control / IP address]

Displays [On] / [Off] of [Network control] function and IP address.

#### [Serial ID / Terminal]

Displays ON/OFF of the function to control with ID, and displays the terminal to use when serial-controlling.

#### [Serial out terminal]

Displays the terminal used for the serial communication output.



### [Controller ID / Terminal]

Displays ON/OFF of the function to control with ID, and displays the terminal to use when controlling with the remote control.

### [Controller out terminal]

Displays the terminal used for the remote control communication output.

### ② Set each item.

Multi control auto setting(DIGITAL LINK)		
Status	Wait	
DIGITAL LINK daisy chain	020/025	
Display ID	0	
Network control / IP address	Off	192.168.0.8
Serial ID / Terminal	On	SERIAL IN
Serial out terminal	SERIAL OUT	
Controller ID / Terminal	On	Built-in
Controller out terminal	IR OUT	
Start		
Display ID	◀ 1 ▶	
Changing network control	Yes	
Changing Serial/IR terminal	Yes	

### [Display ID]

Sets the ID you want to assign to the display you are operating.

#### [Auto], 1 to 100

When setting to [Auto], the ID is set using the number counted from the first unit connected with the DIGITAL LINK daisy chain.

Example: 15th unit counted from the beginning  
ID: 15

#### Note

- When connected with the DIGITAL LINK daisy chain, the ID number and control terminal are automatically set for the preceding-stage display before the display on which the operation is performed.

### [Changing network control]

Sets whether to change settings in [Network control] or maintain the current settings.

#### [No]:

Maintains the settings.

#### [Yes]:

Switches [Network control] to [On] when it is set to [Off], and switches [DHCP] to [On].

### [Changing Serial/IR terminal]

Sets whether to change the control terminal setting or maintain the current setting when performing auto setup.

**[No]:** Maintains the settings.

**[Yes]:** The setting of each IN/OUT terminal connected via DIGITAL LINK are changed to [DIGITAL LINK].

#### Note

- If there is a terminal connected with the DIGITAL LINK daisy chain on the display with only the input side or the output side connected, the setting will be changed.

### ③ Select [Start] and press <ENTER>.

Starts auto setting.

The following screen is displayed when the setting is completed.

Multi control auto setting(DIGITAL LINK)		
Status	Finished	
DIGITAL LINK daisy chain	020/025	
Display ID	1	
Network control / IP address	On	192.168.0.8

- When [DHCP] is set to [On], IP address is updated automatically.

The following screen is displayed on the subsequent-stage displays.

Multi control auto setting(DIGITAL LINK)		
Status	Finished	
DIGITAL LINK daisy chain	021/025	
Display ID	2	
Network control / IP address	On	192.168.0.9

- For each subsequent-stage display, an ID number with 1 added to the ID number of each preceding-stage display is assigned.  
If the ID number of the preceding-stage display is "100", ID number "1" is set.
- When [DHCP] is set to [On], IP address is updated automatically.

## Multi display settings

1 to 10 displays can be aligned in horizontal direction and vertical direction respectively, and those displays are regarded as one group. The enlarged image is shown on the combined display.

[Multi display settings] - submenu screen

Multi display settings	
Multi display setting	Off
Horizontal scale	2
Vertical scale	2
Bezel H adjustment	0
Bezel V adjustment	0
Location	A1
Frame control	1
Reverse scan	Off

### Note

- The settings are memorised separately for each input terminal.
- When the multi display is set to [Off], adjust to the same angle of view for [Position] (see page 42). Then, set the multi display to [On]. Again, make fine adjustment of the angle of view for [Position].
- The [Position] menu can be adjusted in the multi display status.
- When using the USB input, [Frame control] and [Reverse scan] cannot be set.
- [Frame control] and [Reverse scan] functions are effective when all of the vertical synchronizations input into each display are the same.

## ■ [Multi display setting]

### [Off]:

The display is not divided when enlarged.

### [On]:

The display is divided when enlarged.

When [On] is set, the display aspect is [16:9].

### To control with the remote control:

Switches ON / OFF by pressing <MULTI DISPLAY>.

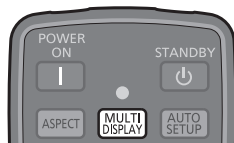

## ■ [Horizontal scale]

Set the horizontal scale in the multi display.

**1 to 10** (1 to 2 for USB input)

## ■ [Vertical scale]

Set the vertical scale in the multi display.

**1 to 10** (1 to 2 for USB input)

Example:

[Horizontal scale] [5] and [Vertical scale] [5] is set in the multi display

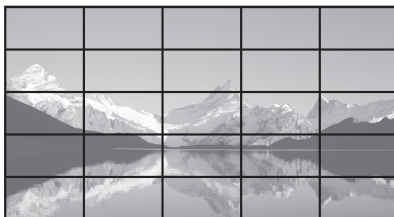

## ■ [Bezel H adjustment], [Bezel V adjustment]

Adjust the area of image hidden in the joint horizontally and vertically respectively.

**0 to 100**

Display example

Setting value: 0

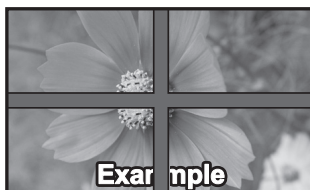

Displays the entire image including the joint area.  
(Suitable when displaying character information on PC.)

Setting value: 100



Does not display the image of the joint area.  
(Suitable when displaying motion pictures.)

## ■ [Location]

Assign the multi display position.

Example:

[Horizontal scale] [10], [Vertical scale] [10]

A1	A2	....	A9	A10
B1	B2	....	B9	B10
....	....	....	....	....
I1	I2	....	I9	I10
J1	J2	....	J9	J10

Select from A1 to J10.

- The displayed content for setting changes according to the settings for the [Horizontal scale] and [Vertical scale].
- By setting [Multi display setting] to [Off], it is possible to check the location on the screen while the setting menu is displayed.

## ■ [Frame control]

Adjusts the image display timing to display motion pictures more naturally in one screen composed of multiple screens.

**[Auto]:**

When [Multi display setting] is set to [On], the image display timing is automatically set in accordance with [Location] of vertical direction.

However, when [Multi display setting] is set to [Off], the image display timing adjustment value is fixed to [0] (not adjusted).

**1 to 5:**

Image display timing adjusted value (manual setting)

This function is operated regardless of the setting in [Multi display setting] ([On] / [Off]).

**Note**

- When any of [1] to [5] is set, and signals over a vertical frequency of 60Hz are input, the unit may not perform control operation as intended.

Also, if signals over 1080 dots in a longitudinal direction are input, a screen error may occur.

- When changing the setting of this function, picture disturbance may occur. This is not a malfunction.

## ■ [Reverse scan]

Reverses the image scan direction to display motion pictures more naturally in one screen composed of multiple screens.

**[Off]:**

Normal scan (Top to bottom)

**[On]:**

Reversed scan (Bottom to top)

**Note**

- This function can only be set when [Frame control] is set to [1] to [5].
- This function is operated regardless of the setting in [Multi display setting] ([On] / [Off]).
- Displayed picture will be interrupted while changing setting of this function.

## Input search

When a signal is not detected, another input with a signal is automatically selected.

Input search	
Input search	◀ Custom ▶
1st search input	(None)
2nd search input	(None)

**[Input search]**

**[Off]:** When there is no signal, the input is not switched automatically.

**[All inputs]:** Searches all inputs and switches to an input with a signal.

Input search is executed in the following order.

Example: When the current input is HDMI

[DisplayPort] → [DIGITAL LINK] → [DVI-D1] → [DVI-D2] → [PC] → [COMPONENT]\* → [VIDEO] → [USB] → [HDMI]

**Note**

- The inputs set to [(Skip)] in [Input label] (see page 66) are skipped when searching.
- When Y/G/VIDEO terminal is used as VIDEO input, set [COMPONENT]\* to [(Skip)].

\*: [COMPONENT] may be displayed as [RGB] depending on the settings of [Component/RGB-in select]. (see page 52)

**[Custom]:** Repeatedly searches [Current input], [1st search input] and [2nd search input] in order, and switches to an input with a signal.

**[Input detection]:** Monitors the following inputs set to [On], detect the status change from no signal to signal present, and switches to the input.

[HDMI], [DIGITAL LINK], [DVI-D1], [DVI-D2], [PC]

**Note**

- If the DIGITAL LINK terminal receives output from another unit, [Input detection] may not operate normally.

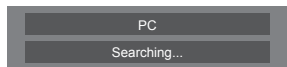

[Searching...] is displayed during the input search.

## [1st search input], [2nd search input]

Set the input to search when [Custom] is selected.

[HDMI] / [DisplayPort] / [DIGITAL LINK] / [DVI-D1] / [DVI-D2] / [PC] / [COMPONENT]\* / [VIDEO] / [USB] / [(None)]

\*: [COMPONENT] may be displayed as [RGB] depending on the settings of [Component/RGB-in select]. (see page 52)

## [HDMI], [DIGITAL LINK], [DVI-D1], [DVI-D2], [PC]

Sets the input for signal detection during [Input detection].

[Off]: Signal detection is not performed for the set input.

[On]: Signal detection is performed for the set input.

## [Changing delay]

Sets the delay time until the input is switched during [Input detection].

[Off]: Switches the input if a signal is interrupted even for a very short period.

1 – 10: Sets the delay time (sec.).

Switches the input when the set time has elapsed after detecting no signal is present. However, if the detection period during which no signal is present is shorter than the set delay time, the input is not switched.

### Note

- With the USB input, the unit determines no signal is present when the USB memory is not connected to the USB terminal.

In addition, even when a USB memory is connected, if there is no playable file, the unit determines no signal is present.

- This menu will be greyed out and cannot be set under the following conditions.
  - [Input lock] is not set to [Off]. (see page 80)
  - [Failover/Fallback] - [Input change mode] is not set to [Off]. (see page 60)
- If the input is changed by this function, the last input is selected when the power is turned on next time.

If you wish to retain the original input when the power is turned on, set [Initial input] to the original input. (see page 80)

- [Input detection] is the function that automatically switches the input as below by monitoring the presence of signal for the set input.
  - If a video signal is input to the set input that is not displayed (When the status has changed from signal absent to signal present.), the input is selected and switched.
  - If no signal is detected for the displayed input, the setting switches to the set input to which a signal is input. Also, if no signal is present for the displayed input when the power is turned on or when the input is switched, the setting switches to the set input to which a signal is input. When signals are input to multiple set inputs, the priority order as default (immediately after power-on) is as follows: HDMI, DIGITAL LINK, DVI-D1, DVI-D2, PC.

In the other case (When the input is switched after power-on), the input displayed last takes priority.

- [Changing delay] is the function to prevent the accidental input switch during a short period, such as when the signal is interrupted due to the frequency change for the input signal while [Input detection] is operating.  
If a signal is detected again within the set period (sec.), the input is not switched.
- [Input detection] may not operate correctly depending on the image playback device.
- [Input detection] may not operate correctly when connected with the DIGITAL LINK daisy chain.

## Failover/Fallback

Automatically switches to the backup input video if an interruption of video occurs.

### [Input change mode]

#### [Off]:

Disables the Backup Input function.

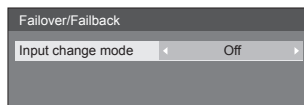

#### [Quick]:

Promptly switches to the backup input (Failover) or puts back to the original input (Fallback) if an interruption of video occurs.

The backup video signal needs to be in the same format as the (main) input in use for viewing.

Upon switching to the backup input, the video and audio adjustment values for the (main) input used for viewing will be inherited.

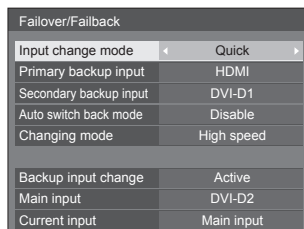

#### [Normal]:

Promptly switches to the backup input or puts back to the original input if an interruption of video occurs.

The backup video signal does not need to be in the same format as the (main) input in use for viewing.

Upon switching to the backup input, the video and audio adjustment values for the backup input will be used.

## ■ [Input change mode]: [Quick]

Promptly switches to the backup input if an interruption of video occurs, and enables switching between digital (HDMI / DIGITAL LINK / DVI-D1 / DVI-D2) inputs.

### Note

- The backup video signal needs to be in the same format as the (main) input in use for viewing.
- Upon switching to the backup input, the video and audio adjustment values for the (main) input used for viewing will be inherited.
- This function will start operating once a video signal is detected by both the input in use for viewing and the backup input and the [Backup input change] item is displayed as [Active].
- This function may not operate correctly depending on the image playback device.

## [Primary backup input]

Sets the first priority backup input.

**(None) / [HDMI] / [DIGITAL LINK] / [DVI-D1] / [DVI-D2]**

The input that is of the same type as the one in use for viewing will be greyed out.

## [Secondary backup input]

Sets the second priority backup input.

**(None) / [HDMI] / [DIGITAL LINK] / [DVI-D1] / [DVI-D2]**

The input that is of the same type as the one in use for viewing will be greyed out.

## [Auto switch back mode]

Sets whether or not to automatically return to the former (main) input when the former input video initially viewed is restored while viewing the video of the backup input enabled by the operation of the Backup Input function. (Failback)

### [Disable]:

Unreturned

### [Enable]:

Returned

## [Changing mode]

Select speed of input switching.

### [High speed]:

If switching between the same signal formats, it is possible to switch within 1 second.

If switching between the different signal formats, picture noise may be caused.

### [Normal speed]:

If switching between the same signal formats, it is possible to switch within 2 seconds.

If switching between the different signal formats, it takes 3 to 4 seconds to switch but picture noise is not caused.

## [Backup input change]

Displays whether or not operating conditions for the Backup Input function are met.

### [Inactive]:

Indicates that the conditions are not met, and inactivates the Backup Input function.

### [Active]:

Indicates that the conditions are met, and activates the Backup Input function.

## [Main input]

Displays the (main) input initially used for viewing.

## [Current input]

Displays whether the input currently in use for viewing is the (main) input initially used for viewing or the backup one.

## Setting conditions

The following table describes restrictions (available combinations) on each setting item.

		Main		
		HDMI DIGITAL LINK DVI-D1 DVI-D2	PC COMPONENT* VIDEO	USB
Backup	HDMI DIGITAL LINK DVI-D1 DVI-D2	○	×	×
	PC COMPONENT* VIDEO	×	×	×
	USB	×	×	×

○: Selectable for both Primary and Secondary.

×: Not selectable for neither Primary nor Secondary.

\*: [COMPONENT] may be displayed as [RGB] depending on the settings of [Component/RGB-in select]. (see page 52)

## Recall display

Pressing <RECALL> displays any of the followings.

- When the main input is being used for viewing and the operating conditions for the Backup Input function are met.

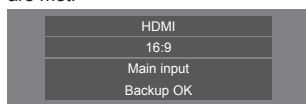

- When the backup input, enabled by the operation of the Backup Input function, is being used for viewing.

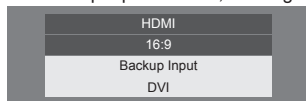

When the conditions for the Backup Input function are met, the following screen is displayed.



## ■ [Input change mode]: [Normal]

Switches to the backup input if an interruption of video occurs.

### Note

- Upon switching to the backup input, the video and audio adjustment values for the backup input will be used.
- When an analogue (PC, COMPONENT or VIDEO) input is being used for viewing, you cannot set an analogue (PC, COMPONENT or VIDEO) input as a backup input.
- Any analogue (PC, COMPONENT or VIDEO) input cannot be set as [Primary backup input] or [Secondary backup input].
- This function will start operating once a video signal is detected by both the input in use for viewing and the backup input and the [Backup input change] item is displayed as [Active].

### [Primary backup input]

Sets the first priority backup input.

**(None) / [HDMI] / [DIGITAL LINK] / [DVI-D1] / [DVI-D2] / [PC] / [COMPONENT]\* / [VIDEO] / [USB]**

The input that is of the same type as the one in use for viewing will be greyed out.

When an analogue (PC, COMPONENT or VIDEO) input is being used for viewing, you cannot set an analogue (PC, COMPONENT or VIDEO) input as a backup input.

Any analogue (PC, COMPONENT or VIDEO) input cannot be set as [Primary backup input] or [Secondary backup input].

### [Secondary backup input]

Sets the second priority backup input.

**(None) / [HDMI] / [DIGITAL LINK] / [DVI-D1] / [DVI-D2] / [PC] / [COMPONENT]\* / [VIDEO] / [USB]**

The input that is of the same type as the one in use for viewing will be greyed out.

When an analogue (PC, COMPONENT or VIDEO) input is being used for viewing, you cannot set an analogue (PC, COMPONENT or VIDEO) input as a backup input.

Any analogue (PC, COMPONENT or VIDEO) input cannot be set as [Primary backup input] or [Secondary backup input].

### [Auto switch back mode]

Sets whether or not to automatically return to the former (main) input when the former input video initially viewed is restored while viewing the video of the backup input enabled by the operation of the Backup Input function.

#### [Disable]:

Unreturned

#### [Enable]:

Returned

### [Backup input change]

Displays whether or not operating conditions for the Backup Input function are met.

#### [Inactive]:

Indicates that the conditions are not met, and inactivates the Backup Input function.

#### [Active]:

Indicates that the conditions are met, and activates the Backup Input function.

### [Main input]

Displays the (main) input initially used for viewing.

### [Current input]

Displays whether the input currently in use for viewing is the (main) input initially used for viewing or the backup one.

\*: [COMPONENT] may be displayed as [RGB] depending on the settings of [Component/RGB-in select]. (see page 52)

### Setting conditions

The following table describes restrictions (available combinations) on each setting item.

		Main		
		HDMI DIGITAL LINK DVI-D1 DVI-D2	PC COMPONENT* VIDEO	USB
Backup	HDMI DIGITAL LINK DVI-D1 DVI-D2	○	○	○
	PC COMPONENT* VIDEO	△	×	△
	USB	○	○	×

○: Selectable for both Primary and Secondary.

△: Selectable for either Primary or Secondary.

×: Not selectable for neither Primary nor Secondary.

\*: [COMPONENT] may be displayed as [RGB] depending on the settings of [Component/RGB-in select]. (see page 52)

### Recall display

Pressing <RECALL> displays any of the followings.

- When the main input is being used for viewing and the operating conditions for the Backup Input function are met.

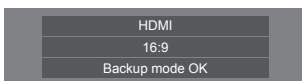

- When the backup input, enabled by the operation of the Backup Input function, is being used for viewing.

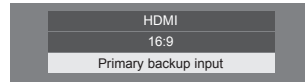

When the conditions for the Backup Input function are met, the following screen is displayed.

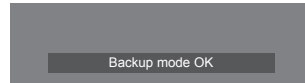

#### Note

- This menu will be greyed out and cannot be set when [Input search] is set to the item other than [Off]. (see page 59)
- With the USB input, the unit determines video signals are interrupted by judging the USB memory is not connected to the USB terminal.
- Switching to the input connected with the daisy chain via DIGITAL LINK requires the switching time.
- This function may not operate correctly depending on the image playback device.

## Colour matching function

Corrects unevenness of colours among multiple screens. R (red), G (green), B (blue) and intermediate colours (cyan, magenta and yellow) are corrected individually on each display.

### Note

- When displaying still picture with USB input (USB media player), it does not have an effect on the picture.

[Colour matching function] - submenu screen

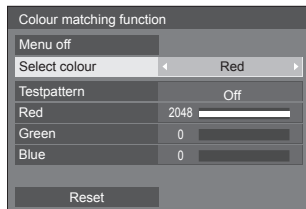

### [Select colour]

Select the colour to correct with ◀▶.

### [Testpattern]

#### [On]:

Displays the test pattern of the selected colour.  
(The sound is muted.)

#### [Off]:

Displays the normal input signals.

### [Red]

Finely adjusts the intensity of red component.

**0 to 1023 or 1024 to 2048**

### [Green]

Finely adjusts the intensity of green component.

**0 to 1023 or 1024 to 2048**

### [Blue]

Finely adjusts the intensity of blue component.

**0 to 1023 or 1024 to 2048**

### [Reset]

Restores each adjustment of all colour selections to default.

Select [Yes] with ◀▶ and press <ENTER>.

## ■ To restore each adjustment of the selected colour to default

Press <DEFAULT> while the menu is displayed, then each adjustment of the selected colour is restored to default.

## ■ [Menu off]

Adjustable when the [Colour matching function] menu is not displayed.

Select [Menu off] and press <ENTER>.

The menu display disappears, and the remote control operation is enabled.

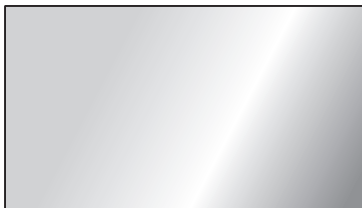

- Pressing <RETURN> displays the menu.
- Pressing <RECALL> displays the operation guide.

### Note

- While the menu is deleted, this setting will finish in 60 minutes after no operation, regardless of the [Menu display duration] (see page 77) setting.



## Remote control operation while the menu is deleted

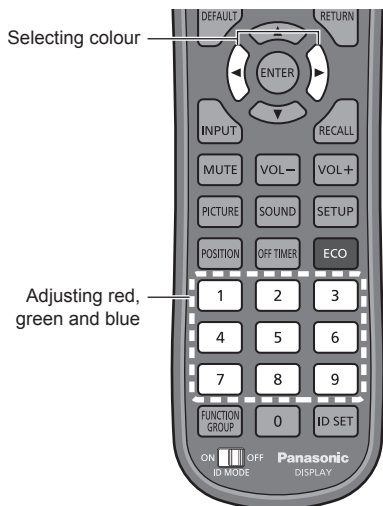

Displayed for 5 seconds if remote control operation is performed.



### [Select colour]

Select the colour to correct with ◀▶.

### Adjusting red, green and blue

Adjust with numeric buttons (<1> to <9>).

<b>Red</b>	<1> -
	<2> Press and hold to reset to default.
	<3> +
<b>Green</b>	<4> -
	<5> Press and hold to reset to default.
	<6> +
<b>Blue</b>	<7> -
	<8> Press and hold to reset to default.
	<9> +

- Pressing and holding <1><4><7> and <3><6><9> will increase or decrease the value in succession.
- Pressing <2><5><8> briefly will show the current value.

#### Note

- While the menu is deleted, this setting cannot be operated with the buttons on the unit.

## Screensaver (For preventing image retention)

Do not display a still picture, especially in 4:3 mode, for any length of time.

If the display must remain on, a Screensaver should be used.



### ■ Screensaver settings

#### Screensaver operation

When the Screensaver is operating, the following 5 patterns are displayed full screen for 5 seconds each, and it will be repeated.

Black → Dark grey → Grey → Light grey → White → Light grey → Grey → Dark grey

#### To start Screensaver now

- Select [On] in [Mode].
- Select [Start] and press <ENTER>.
  - The menu screen will disappear and the Screensaver will be activated.

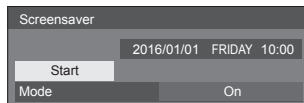

#### Note

- If the following buttons are pressed while the screen saver is operating, the screen saver is cancelled.  
Remote control: <RETURN>  
Main unit: <MENU (Unit)> <INPUT> <+ (Unit)> <- (Unit)> ▲▼ <ENTER (Unit)>
- When the display is turned off, the Screensaver will be deactivated.

#### To set interval of Screensaver

- Select [Interval] in [Mode].
- Set [Periodic time].
  - Press ◀▶ to change the time by 15 minutes.
  - In [ENGLISH(US)] OSD language, [Periodic time] is displayed as [SHOW DURATION].
- Set [Operating time].
  - Press ◀▶ once to change the time by 1 minute. Keep pressing down to change the time by 15 minutes.
  - In [ENGLISH(US)] OSD language, [Operating time] is displayed as [SAVER DURATION].

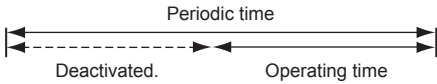
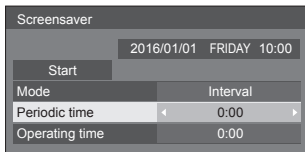

**Note**

- It is not possible to set the duration of [Operating time] longer than that of [Periodic time].

**To set start and finish time of Screensaver**

- Select [Time designation] in [Mode].
- Set [Start time] and [Finish time].
  - Press ◀▶ once to change the time by 1 minute. Keep pressing down to change the time by 15 minutes.
  - In [ENGLISH(US)] OSD language, [Time designation] is displayed as [TIME OF DAY].

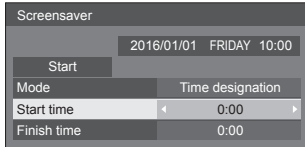

**Note**

- When the current time is displayed as [- :], set [Date and time] before setting [Start time] and [Finish time]. (see page 70)

**To turn the power off after Screensaver**

- Select [Standby after SCR saver] in [Mode].
- Set [Screensaver duration].
  - Press ◀▶ once to change the time by 1 minute. Keep pressing down to change the time by 15 minutes.
- Select [Start] and press <ENTER>.
  - Screensaver will be activated and the power will be turned off (Standby) at the time set.

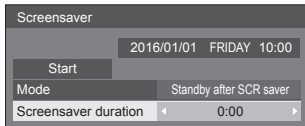

**Note**

- [Screensaver duration] can be set from 0:00 to 23:59. When this is set to [0:00], [Standby after SCR saver] will not be activated.

**Input label**

This function can change the label of the Input signal to be displayed.

[Input label] - submenu screen

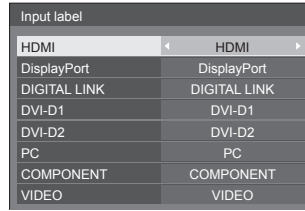

<b>[HDMI]</b>	[HDMI] / [DVD1] / [DVD2] / [DVD3] / [Blu-ray1] / [Blu-ray2] / [Blu-ray3] / [CATV] / [VCR] / [STB] / (Skip)
<b>[DisplayPort]</b>	[DisplayPort] / [DVD1] / [DVD2] / [DVD3] / [Blu-ray1] / [Blu-ray2] / [Blu-ray3] / [CATV] / [VCR] / [STB] / (Skip)
<b>[DIGITAL LINK]</b>	[DIGITAL LINK] / [DVD1] / [DVD2] / [DVD3] / [Blu-ray1] / [Blu-ray2] / [Blu-ray3] / [CATV] / [VCR] / [STB] / (Skip)
<b>[DVI-D1]</b>	[DVI-D1] / [DVD1] / [DVD2] / [DVD3] / [Blu-ray1] / [Blu-ray2] / [Blu-ray3] / [CATV] / [VCR] / [STB] / (Skip)
<b>[DVI-D2]</b>	[DVI-D2] / [DVD1] / [DVD2] / [DVD3] / [Blu-ray1] / [Blu-ray2] / [Blu-ray3] / [CATV] / [VCR] / [STB] / (Skip)
<b>[PC]</b>	[PC] / [DVD1] / [DVD2] / [DVD3] / [Blu-ray1] / [Blu-ray2] / [Blu-ray3] / [CATV] / [VCR] / [STB] / (Skip)
<b>[COMPONENT]*</b>	[COMPONENT] / [DVD1] / [DVD2] / [DVD3] / [Blu-ray1] / [Blu-ray2] / [Blu-ray3] / [CATV] / [VCR] / [STB] / (Skip)
<b>[VIDEO]</b>	[VIDEO] / [DVD1] / [DVD2] / [DVD3] / [Blu-ray1] / [Blu-ray2] / [Blu-ray3] / [CATV] / [VCR] / [STB] / (Skip)

(Skip): When <INPUT> is pressed, the input will be skipped.

\*: [COMPONENT] may be displayed as [RGB] depending on the settings of [Component/RGB-in select]. (see page 52)

## Power management settings

Set each item to reduce power consumption.

This function works only for the input terminal that is currently selected.

[Power management settings] - submenu screen

Power management settings	
Power management mode	Custom
No signal power off	Disable
HDMI power management	Off
DIGITAL LINK power management	Off
DVI-D1 power management	Off
DVI-D2 power management	Off
PC power management	Off
Extended standby mode	Off

### To control with the remote control:

Switches [Power management mode] by pressing <ECO>.

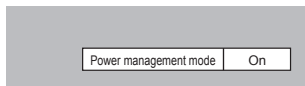

### ■ [Power management mode]: [On]

The following fixed values are set to the menu of power consumption reduction. Individual setting is not available.

[No signal power off]: [Enable]

[HDMI power management]: [On]

[DIGITAL LINK power management]: [On]

[DVI-D1 power management]: [On]

[DVI-D2 power management]: [On]

[PC power management]: [On]

### ■ [Power management mode]: [Custom]

The menu of the power consumption reduction is individually set. This setting is enabled when [Power management mode] is set to [Custom].

### [No signal power off]

When this is set to [Enable], the power supply of the unit goes off automatically when there is no operation or sync signal for about 10 minutes.

#### Note

- With the USB input, the unit determines no signal is present when the USB memory is not connected to the USB terminal, or the connected USB memory does not contain any playable file.
- This function may not operate depending on the video output devices.

### [HDMI power management]

When this function is set to [On], it operates under the following conditions to turn the power on or off automatically.

#### When no pictures (sync signal) are detected for 60 seconds or so at HDMI input:

Power is turned off (standby); the power indicator lights up orange.

#### When pictures (sync signal) are subsequently detected at HDMI input:

Power is turned on; the power indicator lights up green.

### [DIGITAL LINK power management]

When this function is set to [On], it operates under the following conditions to turn the power on or off automatically.

#### When no pictures (sync signal) are detected for 60 seconds or so at DIGITAL LINK input:

Power is turned off (standby); the power indicator lights up orange.

#### When pictures (sync signal) are subsequently detected at DIGITAL LINK input:

Power is turned on; the power indicator lights up green.

### [DVI-D1 power management]

When this function is set to [On], it operates under the following conditions to turn the power on or off automatically.

#### When no pictures (sync signal) are detected for 60 or so seconds at DVI-D1 input:

Power is turned off (standby); the power indicator lights up orange.

#### When pictures (sync signal) are subsequently detected at DVI-D1 input:

Power is turned on; the power indicator lights up green.

### [DVI-D2 power management]

When this function is set to [On], it operates under the following conditions to turn the power on or off automatically.

#### When no pictures (sync signal) are detected for 60 or so seconds at DVI-D2 input:

Power is turned off (standby); the power indicator lights up orange.

#### When pictures (sync signal) are subsequently at DVI-D2 input:

Power is turned on; the power indicator lights up green.

### [PC power management] (DPMS function)

When this function is set to [On], it operates under the following conditions to turn the power on or off automatically.

#### When no pictures (HD/VD sync signals) are detected for 60 or so seconds at PC input:

Power is turned off (standby); the power indicator lights up orange.

#### When pictures (HD/VD sync signals) are subsequently detected at PC input:

Power is turned on; the power indicator lights up green.

#### Note

- This function is effective when [Sync] in [Signal] is set to [Auto] or [HV sync] and [Component/RGB-in select] are set to [RGB]. (see page 52)

### [Extended standby mode]

Sets the operation in standby mode by the "Power management" function for the input terminal for which the "Power management" function is set to [On].

**[On]:** If a video signal (synchronized signal) is detected at any of the input terminals for which the "Power management" function is set to [On], the power is turned "ON", and the input is switched to the detected input.

**[Off]:** If a video signal (synchronized signal) is detected at the input terminal with which the standby mode is entered, the power is turned "ON" with the input.

#### Note

- If [Input search] is set to items other than [Off], the [Input search] function is prioritised. (The "Power management" function does not operate for each terminal.) (For details of [Input search] function, see page 59.)
- If [Failover/Failback] - [Input change mode] is set to items other than [Off], the [Failover/Failback] function is prioritised. (The "Power management" function does not operate for each terminal.) (For details of [Failover/Failback] function, see page 60.)

## Wobbling

Automatically shifts the display image (therefore unnoticeable to the eye) to prevent image retention of sharper contour of image.

Setting this to [On] moves the screen position at certain intervals and displays the images.

#### Note

- If [Multi display setting] is set to [On], this function does not operate. (see page 58)
- When this function is operating, part of the screen may appear to be missing.

## DIGITAL LINK out

Sets the signal to output from DIGITAL LINK OUT terminal.

<b>[Monitor out(Digital)]:</b>	The input signal which is currently selected (only when digital signal is selected)
<b>[HDMI]:</b>	HDMI input signal
<b>[DisplayPort]:</b>	DisplayPort input signal
<b>[DIGITAL LINK]:</b>	DIGITAL LINK input signal
<b>[DVI-D1]:</b>	DVI-D1 input signal
<b>[DVI-D2]:</b>	DVI-D2 input signal
<b>[Off]:</b>	The signal is not output.

#### Note

- When outputting the HDMI, DisplayPort, or DIGITAL LINK input signal, if the audio signal is multiplexed, the signal is output. Analogue audio is not output.

## No activity power off

When this function is set to [Enable], the power is turned off (standby) automatically when there is no operation of the Display for 4 hours.

Starting from 3 minutes before the turn off, the remaining time will be displayed.

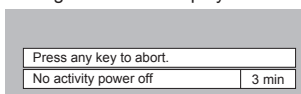

When the power is turned off due to this function, a message [Last turn off due to 'No activity power off. '] is displayed next time the power is turned on.

#### Note

- While the screensaver is running, this function is disabled.

## Power ON screen delay

You can set the power-on delay time of the displays to reduce the power load, when turning on the power of the multiple displays that are set together.

Set each display's setting individually.

### [Off]:

When the display is switched to power-on state, it is powered on at once.

### [Auto]:

Sets the delay time automatically according to the number set for [Display ID].

The delay time is determined by multiplying [Display ID] × 0.3 seconds.

Example:

When [Display ID] is 3 → 0.9 seconds

[Display ID] (see page 55)

### 1 to 30:

Set the power-on delay time (second).

When the display is switched to power-on state, it is powered on with time delay in accordance with the setting.

### Note

- While this function is working, the power indicator is blinking green.
- This function also works when the power recovers from failure or after plugging off and in again the power cord.

## OSD language

Select your preferred language.

### Selectable languages

English(UK)

Deutsch

Français

Italiano

Español

ENGLISH(US)

中文 : Chinese

日本語 : Japanese

Русский : Russian

## Set up timer

Sets the program to turn the power on with the specified time and video input, or to turn the power off at the specified time. Up to 20 programmes can be set.

### Note

- When the current time is displayed as [- -], set [Date and time] before setting [Set up timer]. (see page 70)
- When multiple programs are set at the same time, the program with the smallest program number is enabled.
- If [Power mode] is set to [Power on], executing the program at power-on will switch to the input set for [Input].

[Set up timer] - submenu screen

Setting Example

Program 1, Every Monday, 12:00,

Power On, Input: HDMI

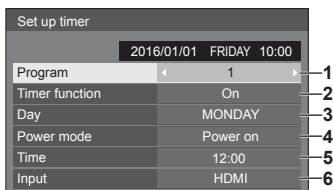

- 1 Set the program number.
- 2 To execute the program, set to [On].  
The program is disabled when [Off] is set.
- 3 Set the day.  
The program is executed every day when [Everyday] is set.
- 4 Set the power On/Off.
- 5 Set the time.  
Pressing ◀▶ once changes time 1 minute.  
Pressing continuously changes time by 15 minutes.
- 6 Set the input.

## Date and time

Set date and time. ([- -] shows no programme is set.)

[Date and time] - submenu screen

Date and time	
	2016/01/01 FRIDAY 10:00
Set	
Year	2016
Month	1
Day	1
Hour	10
Minute	0

### ■ Set date and time

- ① Select [Year / Month / Day / Hour / Minute].
- ② Set the selected item.



Date and time	
	2016/01/01 FRIDAY 10:00
Set	
Year	2017
Month	1
Day	1
Hour	10
Minute	0

- ③ Select [Set] and press <ENTER>.

Date and time	
	2017/02/05 SUNDAY 18:00
Set	
Year	2017
Month	2
Day	5
Hour	18
Minute	0

#### Note

- If the present date and time are not set, the time settings for [Set up timer], [Screensaver], etc. cannot be made.
- The present date and time setting is reset in the following case.  
When the main unit is left unattended for 7 days or longer after the main unit is turned off with the <Main power switch>, the power plug is removed, or power failure has occurred, etc.
- Date and time cannot be set when [Year / Month / Day / Hour / Minute] are set to [- -].

## Network settings

Set when networking with a computer.

[Network settings] submenu will be displayed.

Network settings	
Network control	Off
Auto display name	On
Display name	VF1H-000
LAN setup	
Network status	
DIGITAL LINK mode	Auto
DIGITAL LINK status	
DIGITAL LINK menu	
AMX D. D.	Off
Crestron Connected™	Off
Extron XTP	Off
USB memory network settings	Permit
Reset	

### ■ [Network control]

Set when controlling with the unit's LAN terminal.

#### [On]:

Controls via LAN using the LAN terminal of the Display. The power indicator lights orange when the power is turned off with the remote control (standby).

#### [Off]:

Invalidates control with LAN terminal.

(In this case, the power consumption of Standby condition (when the power is turned off with the remote control) will be slightly reduced.)

#### Note

- When using the LAN control function for "Using Network Function" (see page 84 - 98), set this function to [On].

### ■ [Auto display name]

Sets whether to change the display name automatically.

#### [On]:

Changes the display name automatically in accordance with the set point of the display ID.

#### [Off]:

The display name is not changed automatically.

### ■ [Display name]

The name of the Display that is shown on the network can be changed.

#### Note

- The name can be changed only when [Auto display name] is set to [Off].
- Display ID is not reset to default with [Network settings] - [Reset].

## ■ [LAN setup]

Detailed network settings for the LAN established via the LAN terminal of the Display can be configured.

Select [LAN setup] with ▲ ▼ and press <ENTER>.

LAN setup	
Save	
DHCP	Off
IP address	192.168. 0. 8
Subnet mask	255.255.255. 0
Gateway	192.168. 0. 1
Port	1024
MAC address	-----

### [DHCP] / [IP address] / [Subnet mask] / [Gateway]

#### ① Set [On] / [Off] of [DHCP] with ◀▶.

When [Off] is selected, IP address and other settings can be set manually.

#### [DHCP]:

(DHCP client function)

##### [On]:

Obtains an IP address automatically when a DHCP server exists in the network the Display is going to be connected.

##### [Off]:

When a DHCP server does not exist in the network the Display is going to be connected, set [IP address], [Subnet mask] and [Gateway] manually.

#### [IP address]:

(IP address display and setting)

Enter an IP address when DHCP server is not used.

#### [Subnet mask]:

(Subnet mask display and setting)

Enter a Subnet mask when DHCP server is not used.

#### [Gateway]:

(Gateway address display and setting)

Enter a gateway address when DHCP server is not used.

#### Note

- When [DHCP] is set to [On], the IP address, etc. will be displayed in grey.

## Entering numbers

IP address
192.168.000.008

1. Select the address and press <ENTER>.
2. Select digits with ◀▶.
3. Change numbers with ▲ ▼.
4. Press <ENTER>.

You can cancel the change by pressing <RETURN>.

## ② Select [Save] and press <ENTER>.

Save the current network Setup.

#### Note

- To use a DHCP server, make sure the DHCP server is started.
- Contact your network administrator for details on [IP address], [Subnet mask] and [Gateway].
- Shipping condition

[DHCP]: [Off]

[IP address]: 192.168.0.8

[Subnet mask]: 255.255.255.0

[Gateway]: 192.168.0.1

## [Port]

Set the port number used for command control.

Select [Port] and press <ENTER> to set the number.

- The available setting range is 1024 - 65535.
- Entering numbers (see page 71)

#### Note

- When the PLink protocol is used, the port setting is not necessary.

## [MAC address]

Displays the MAC address of this unit.

## ■ [Network status]

Checks the current Network settings status.

Network status	
DHCP	Off
IP address	192.168. 0. 8
Subnet mask	255.255.255. 0
Gateway	192.168. 0. 1
MAC address	12:34:56:78:9A:BC

## ■ [DIGITAL LINK mode]

Switches communication method of DIGITAL LINK terminal.

### [Auto]:

Communication method is selected automatically. HDMI, LAN, serial communication are possible. Ethernet connection is possible.

### [DIGITAL LINK]:

HDMI, LAN, serial communication are possible via a twisted pair cable transmitter.

### [Ethernet]:

LAN communication is possible via the LAN terminal of the display.

### [Long reach]:

Communication method is fixed to Long reach.

### Modes allowing communication

✓ : Valid

— : Invalid

Settings		Communication validity			
		Picture transmission 100 m 150 m		Ethernet	RS-232C
Auto	For DIGITAL LINK	✓	—	✓	✓
	For Long reach	—	✓	✓	✓
	For Ethernet	—	—	✓	—
DIGITAL LINK		✓	—	✓	✓
Long reach		—	✓	✓	✓
Ethernet		—	—	✓	—

### Note

- When connected with the [Long reach] communication method, the maximum transmission distance is 150 m. In this case, this unit can receive the signals of up to 1080/60p (148.5 MHz).
- If the communication method of the twisted pair cable transmitter is set to [Long reach], set [DIGITAL LINK mode] to [Auto]. Then, connection is enabled with the [Long reach] communication method.

When connecting with the separately sold DIGITAL LINK Switcher (ET-YFB200G) with the [Long reach] communication method, set [DIGITAL LINK mode] to [Long reach].

- Even if [DIGITAL LINK mode] is set to [Long reach], when the twisted pair cable transmitter does not support the communication method of [Long reach], it will not be connected properly.

## ■ DIGITAL LINK status

Display the DIGITAL LINK connection environment.

Select [DIGITAL LINK status] with ▲ ▼ and press <ENTER>.

DIGITAL LINK status	
LINK status	No link
HDMI status	No HDMI
Signal quality	
Min	-XX dB
Max	-YY dB

### [LINK status]:

1 of the followings will be displayed.

#### [No link]:

No LAN connection, etc.

#### [DIGITAL LINK]:

Connected to the DIGITAL LINK device by LAN.

#### [Long reach]:

Communication method is set to [Long reach] and is connected to the DIGITAL LINK device by LAN.

#### [Ethernet]:

The PC is connected to the DIGITAL LINK / LAN terminal of this product and is LAN connected.

### [HDMI status]:

Displays the connection status of the HDMI format.

1 of the followings will be displayed.

#### [No HDMI]:

DIGITAL LINK not connected

#### [HDMI on]:

DIGITAL LINK connected

#### [HDCP on]:

HDCP supported on DIGITAL LINK

### [Signal quality]:

It is the quantified minimum and maximum numbers of errors that have occurred. The display colours are red, yellow, or green, depending on the number.

Signal quality	Display Colours	Reception Status
-12dB or below	Green	Good
-11 to -8dB	Yellow	Bad
-7dB or above	Red	Terrible

- The number is represented by yellow or red if the LAN cable is disconnected or the cable is not shielded.
- This signal quality shows figures between the twisted pair cable transmitter that is connected and the display.



## ■ DIGITAL LINK menu

Displays the setting menu of Digital Interface Box.

Select [DIGITAL LINK menu] with ▲ ▼ and press <ENTER>.

### Note

- This function can only be selected when the Panasonic device that supports DIGITAL LINK output (ET-YFB100G, ET-YFB200G) is connected to a DIGITAL LINK / LAN terminal and its power is on.
- For details, refer to the manuals of the devices that support DIGITAL LINK output.

## ■ [AMX D. D.]

Set whether to allow the Display to be detected by AMX Device Discovery.

### [On]:

Enables detection by AMX Device Discovery.

### [Off]:

Disables detection by AMX Device Discovery.

- For more details, visit the following web site.  
<http://www.amx.com/>

## ■ [Crestron Connected™]

When this function is set to [On], the Display can be monitored or controlled via the network using equipment and application software of Crestron Electronics, Inc.

This Display supports the following application software from Crestron Electronics, Inc.

- RoomView® Express
- Fusion RV®
- RoomView® Server Edition

[Crestron Connected™] is a function to connect to a system developed by Crestron Electronics, Inc. which manages and controls multiple system devices connected to the network.

- For details of "Crestron Connected™", refer to the Crestron Electronics, Inc. web site (Provided only in English).

<http://www.crestron.com/>

For the download of "RoomView® Express", refer to the Crestron Electronics, Inc. web site (Provided only in English).

<http://www.crestron.com/getroomview>

## ■ [Extron XTP]

Set to [On] when connecting XTP Transmitter made by Extron to DIGITAL LINK terminal.

- For more details on Extron, visit the following web site.  
<http://www.extron.com>

## ■ [USB memory network settings]

Sets whether to permit the network setting using the USB memory device. (see page 110)

### [Permit]:

Permits USB memory network settings.

### [Prohibit]:

Prohibits USB memory network settings.

### Note

- This function is set to [Permit] as factory default.
- Once the network setting is done with USB memory device, this function is set to [Prohibit].

## ■ [Reset]

You can reset the network setting to the factory default of the Display.

Select [Yes] with ◀▶ and press <ENTER>.

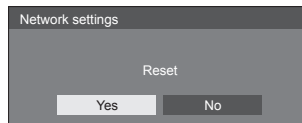

## USB media player settings

Set for [USB media player] function.

[USB media player settings] - submenu screen

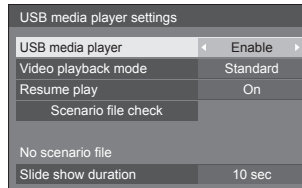

## ■ [USB media player]

Set to enable or disable the [USB media player] function.

## ■ [Video playback mode]

Sets the video playback mode.

If image disturbance occurs at the switching timing of motion picture files during playback in the Standard mode, switch to the Adjust mode.

### [Standard]:

Plays without a black image at the joint between video files.

### [Adjust]:

Plays with a black image (approx. 2 seconds) inserted at the joint between video files.

### Note

- The mode switching is enabled only when using the single media player.
- The display may be disturbed at the switching timing of files during playback in the Standard mode.

## ■ [Resume play]

Set to enable or disable resume play.

## ■ [Scenario file check]

Execute the USB memory contents check. If any error is detected, the error code and file name will be displayed.

For details of the error codes, refer to "USB memory contents check". (see page 104)

Select [Scenario file check] with ▲▼ and press <ENTER>.

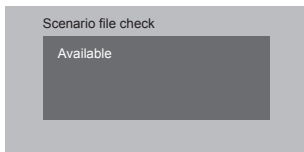

## ■ [Slide show duration]

Select the displaying duration for still images.

[10 sec] to [600 sec]

## Function button settings

Assigns specific functions to the numeric buttons (<0> to <9>). The buttons can be used as shortcut keys by assigning frequently used operations.

### 1 Switch [Function group] with ◀▶.

[Function button settings] - submenu screen

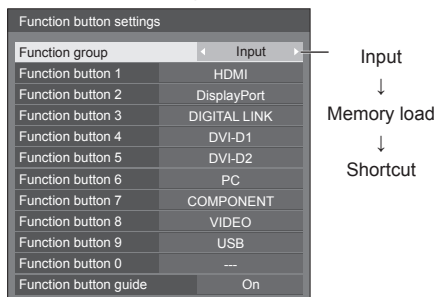

### 2 Select the numeric button with ▲▼ and set the function to assign with ◀▶.

## ■ Functions assignable to the numeric buttons

### [Input] (Direct input select)

Input can be selected with single-touch operation.

[HDMI] / [DisplayPort] / [DIGITAL LINK] / [DVI-D1] / [DVI-D2] / [PC] / [COMPONENT]\* / [VIDEO] / [USB]

\*: [COMPONENT] may be displayed as [RGB] depending on the settings of [Component/RGB-in select]. (see page 52)

### [Memory load]

Memory can be loaded with single-touch operation.

Memory load (see page 49)

### [MEMORY1] to [MEMORY8]

- [MEMORY1] to [MEMORY8] load functions are already assigned to <1> to <8> respectively. These settings cannot be changed.

### [Shortcut]

[Signal], [Screensaver], [Set up timer], [Power management settings], [Network settings], [Multi display settings]

- Pressing the numeric button displays the menu screen. Pressing the button again exits the menu screen.

### [AV mute]

- Pressing the numeric button mutes the audio and pictures.

To cancel, press any button on the remote control except power button.

### [Digital zoom]

- Switches to [Digital zoom] mode by pressing numeric buttons. (see page 39)

### [Display ID / Display name]

- Pressing the numeric button enlarges [Display ID] and [Display name].

## Shipping condition

The following functions are assigned to the numeric buttons as factory default.

	[Input]	[Memory load]	[Shortcut]
1	HDMI	MEMORY1	[Signal]
2	DisplayPort	MEMORY2	[Screensaver]
3	DIGITAL LINK	MEMORY3	[Set up timer]
4	DVI-D1	MEMORY4	[Power management settings]
5	DVI-D2	MEMORY5	[Network settings]
6	PC	MEMORY6	[AV mute]
7	COMPONENT	MEMORY7	[Multi display setting]
8	VIDEO	MEMORY8	[Digital zoom]
9	USB	—	Display ID / Display name
0	—	—	—

## ■ Function button guide

Sets the function display when numeric buttons are pressed. Set this for each function group.

### [On]:

Displays the function list for the numeric buttons.

### [Off]:

Does not display the function list. Operation starts when numeric buttons are pressed.

### Note

- When <FUNCTION GROUP> is pressed, [Function button guide] will be displayed regardless of the [On] / [Off] settings.

## ■ To use shortcut (numeric buttons)

### 1 Press <FUNCTION GROUP> or <0> - <9>.

[Function button guide] will be displayed.

[Function button guide]: When [Off] is set, pressing the numeric button starts operation.

Example: Input

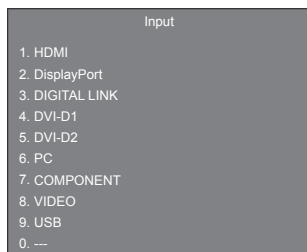

### 2 Press <FUNCTION GROUP> to switch function group.

Example: Memory load

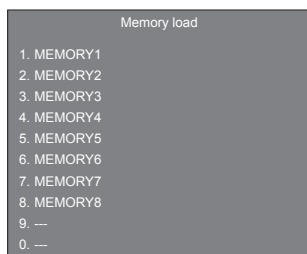

### 3 Press <0> - <9>.

The function for the pressed button starts to operate.

Example: When <2> is pressed.

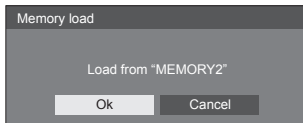

## Startup image settings

Sets the image displayed on the screen when the power is turned on.

### Conditions of the image that can be set in [Read user image]

- Image size: 1920 × 1080 only
- jpg files / bmp files (except for the ones that cannot be played back with [USB media player] (see page 100))

File and folder names are displayed on the file list with conditions as below.

– If a file or folder is placed directly under the root directory of the USB device.

- Up to 246 characters of file name (including the extension) are properly displayed.

Note that the file list may disappear due to the display time of the on-screen menu before the entire display of file names completely appears.

- Up to 244 characters of folder name are properly displayed.

\* If the folder is placed hierarchically, the number of characters displayed decreases by the number of characters for the file path (folder information).

– Only the files with file names described with ASCII characters excluding control code are displayed.

### Note

- [Picture] cannot be adjusted when setting the startup image.
- Image displayed for the startup image may slightly differ from image confirmed on the computer.

[Startup image settings] - submenu screen

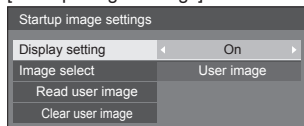

### [Display setting]

Sets the image display when the power is turned on.

#### [Off]:

The function does not operate.

#### [On]:

Enables the function.

### [Image select]

Select the image to display.

#### [Default image]:

Panasonic logo (blue background)

#### [User image]:

Image registered by the user

#### Note

- Only when [Default image] is displayed, the logo automatically rotates when displayed, according to the [Display orientation] (see page 77) setting ([Landscape] / [Portrait]).
- When [User image] is selected, the image does not rotate according to the [Display orientation] setting. Prepare an image of 1920 × 1080 aspect ratio compatible with the installation direction.

### [Read user image]

Register the image read from a USB memory device.

#### [Read user image] - submenu screen

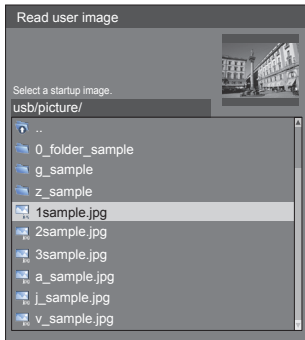

#### Note

- Set the input to something other than USB, and read the image.
- Only one user image can be registered.
- Do not turn the power off while reading the user image.
- The selected image is previewed on the [Read user image] submenu screen.
- While the [Read user image] submenu screen is being displayed, the [USB media player] stops playback.
- When USB memory device is not connected to the USB terminal, [Read user image] is greyed out and cannot be selected.

- If starting to read the image while creating the preview image, an access error will occur, and the image may not be recognized as a image file. Confirm the preview image display, and then start reading process.
- The displayed file names are restricted as follows.
  - Applicable extension: jpg, jpe, jpeg or bmp
  - The file name is not ".jpg", ".jpe", ".jpeg", or ".bmp" which start with dot (.).
- Depending on the OS setting, folders or files in the USB memory invisible on your computer may be displayed on this unit.

### [Clear user image]

Clears the image registered in [Read user image].

#### [Startup image settings] - submenu screen

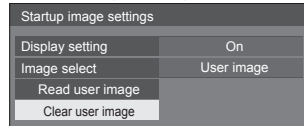

#### Note

- When there is no [User image] that have been read, [Clear user image] is greyed out and cannot be selected.
- When [Image select] is set to [User image], performing [Clear user image] will change the setting of [Image select] to [Default image].

## Display orientation

Sets the on-screen display orientation in the portrait setting.

### [Landscape]:

On-screen display angle is for horizontal installation.

### [Portrait]:

The on-screen display rotates anticlockwise by 90 degrees for easy view in the portrait setting.

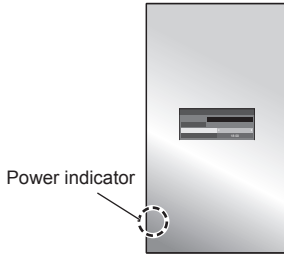

### Note

- For portrait installation, please turn this Display right so that the Power Indicator comes to the downside. (The Power Indicator is situated at the back.)

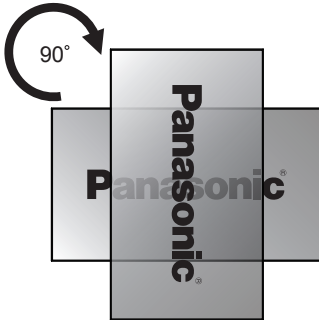

## OSD position

Sets the display position of the on-screen menu.

Each time ◀ or ▶ is pressed, the display position of the on-screen menu changes.

Display example:

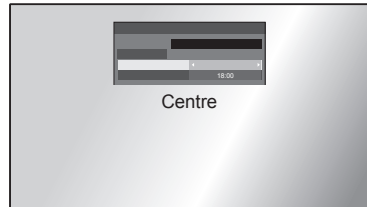
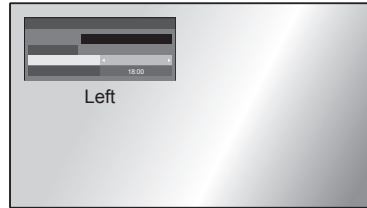

## Menu display duration

Sets the display duration time for the on-screen menu.

**[5 sec] to [180 sec]**

## Menu transparency

Sets the transparency rate of the on-screen menu display background.

**0 to 100**

# Options Adjustments

This unit offers special functions conveniently used according to the installation location and application.

## ■ Remote control

### 1 Press <SETUP>.

[Setup] menu screen will be displayed.

### 2 Select [OSD language] with ▲ ▼ and press <ENTER> for more than 3 seconds.

Following screen will be displayed.

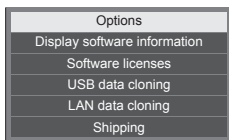

### 3 Select [Options] with ▲ ▼ and press <ENTER>.

[Options] menu screen will be displayed.

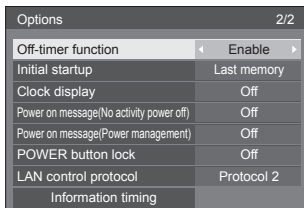
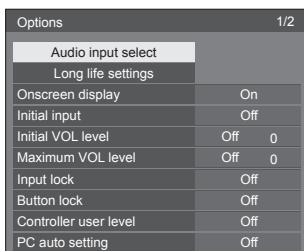

#### Note

- [POWER button lock] function is only for TH-55VF1HU.

### 4 Select the item to set with ▲ ▼.

For [Audio input select], [Long life settings] and [Information timing], the submenu screen will be displayed when you press <ENTER>.

(see page 79, 79, 82)

### 5 Set with ◀ ▶.

### 6 Press <SETUP> to exit from [Options] menu.

## ■ Unit

### 1 Press <MENU (Unit)> for several times and display the [Setup] menu.

### 2 Select [OSD language] with ▲ ▼, and then press and hold <ENTER (Unit)> for more than 5 seconds.

### 3 Select [Options] with ▲ ▼ and press <ENTER (Unit)>.

[Options] menu screen will be displayed.

### 4 Select the item to set with ▲ ▼.

For [Audio input select], [Long life settings] and [Information timing], the submenu screen will be displayed when you press <ENTER>.

(see page 79, 79, 82)

### 5 Set with <- (Unit)> or <+ (Unit)>.

### 6 Press <MENU (Unit)> for several times to exit from [Options] menu.

#### Note

- The remote control is necessary to operate [Initial VOL level] and [Maximum VOL level] in the [Options] menu.
- Press <RETURN> to return to the previous menu.
- The serial number and the software version of this unit are displayed when [Display software information] is selected in step 3.
- The software License is displayed when [Software licenses] is selected in step 3.

## Audio input select

Set up the sound when a video input is selected.

### 1 Select the video input with ▲▼.

Set the audio input with ◀▶.

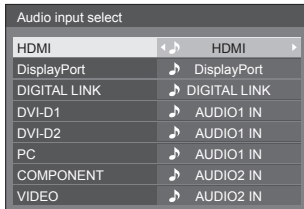

- The illustration above shows the factory settings.

Video input	Audio input
HDMI	HDMI / AUDIO1 IN / AUDIO2 IN / No audio
DisplayPort	DisplayPort / AUDIO1 IN / AUDIO2 IN / No audio
DIGITAL LINK	DIGITAL LINK / AUDIO1 IN / AUDIO2 IN / No audio
DVI-D1 / DVI-D2/ PC / COMPONENT* / VIDEO	AUDIO1 IN / AUDIO2 IN / No audio

- [No audio]: No audio input (Mute)

\*: [COMPONENT] may be displayed as [RGB] depending on the settings of [Component/RGB-in select]. (see page 52)

When the setting for the audio input has been changed from the factory settings, the audio input is displayed as below.

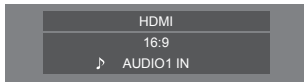

## Long life settings



### [Long life mode]

Extends the panel life by reducing the backlight brightness.

#### [On1]:

Reduces the backlight brightness by approx. 20 percent compared to its maximum.

#### [On2]:

Reduces the backlight brightness by approx. 40 percent compared to its maximum.

#### [Off]:

Does not reduce brightness.

### [Auto brightness adjustment]

Corrects the brightness automatically for the brightness change due to ageing caused by the panel illumination.

#### [On]:

Corrects automatically.

#### [Off]:

Does not correct automatically.

### Note

- This function can be set when the unit is turned on for the first time. (see page 34)  
In case it was not set, it is possible to set under this menu.
- [Auto brightness adjustment] cannot be set to [On] if the panel illumination time exceeds 1000 hours.

## Onscreen display

Set to display / hide the following Onscreen display.

- Power on display
- Input signal switch display
- No signal display
- No external media display (at USB input)
- MUTE display after displaying the menu screen
- Off timer remaining time display when 3 minutes remaining

#### [On]:

Displays the Onscreen display.

#### [Off]:

Hides the Onscreen display.

## Initial input

Adjusts the input signal when the unit is turned on.

[Off] / [HDMI] / [DisplayPort] / [DIGITAL LINK] / [DVI-D1] / [DVI-D2] / [PC] / [COMPONENT]\* / [VIDEO] / [USB]

\*: [COMPONENT] may be displayed as [RGB] depending on the settings of [Component/RGB-in select]. (see page 52)

### Note

- This menu is available only when [Input lock] is [Off]. (see page 80)

## Initial VOL level

Adjusts the sound volume level when the unit is turned on.

### [Off]:

It will be the sound volume level which had been set before the power of the unit was turned off.

### [On]:

Sets your preferred volume.

- Outputs with the set volume when [Initial VOL level] in [On] state is selected on the menu.

### ■ To adjust sound volume level

Press <VOL +> <VOL ->.

### Note

- When [Maximum VOL level] is [On], the volume cannot be set to the level higher than the level set for [Maximum VOL level].

## Maximum VOL level

Adjusts the maximum volume.

### [Off]:

The sound volume level can be set up to 100 (maximum).

### [On]:

The sound volume level will not exceed the set point.

- Outputs with the set volume when [Maximum VOL level] in [On] state is selected on the menu.

### ■ To adjust sound volume level

Press <VOL +> <VOL ->.

### Note

- When the [Maximum VOL level] is switched from [Off] to [On], if the [Maximum VOL level] is set lower than the [Initial VOL level], the [Initial VOL level] automatically becomes the same as the [Maximum VOL level].

## Input lock

Locks the input switch operation.

[Off] / [HDMI] / [DisplayPort] / [DIGITAL LINK] / [DVI-D1] / [DVI-D2] / [PC] / [COMPONENT]\* / [VIDEO] / [USB]

\*: [COMPONENT] may be displayed as [RGB] depending on the settings of [Component/RGB-in select]. (see page 52)

### Note

- Input switch can be used when this is set to [Off].

## Button lock

Limits operation of the buttons on the unit.

### [Off]:

All the buttons on main unit can be used.

### [On]:

All button operations except for the <Power button (Unit)> are disabled.

### [MENU & ENTER]:

Locks <MENU (Unit)> and <ENTER (Unit)> buttons.

### ■ To set [Button lock]

Set with the buttons on the unit.

### [Off]:

- ① Press <+ (Unit)> for 4 times.
- ② Press <INPUT (Unit)> for 4 times.
- ③ Press <- (Unit)> for 4 times.
- ④ Press <ENTER (Unit)>.

### [On]:

- ① Press <- (Unit)> for 4 times.
- ② Press <ENTER (Unit)> for 4 times.
- ③ Press <+ (Unit)> for 4 times.
- ④ Press <ENTER (Unit)>.

### [MENU & ENTER]:

- ① Press <ENTER (Unit)> for 4 times.
- ② Press <+ (Unit)> for 4 times.
- ③ Press <INPUT (Unit)> for 4 times.
- ④ Press <ENTER (Unit)>.

### Note

- About how to reset the settings to defaults: "Initialization" (see page 83)



## Controller user level

Limits operation of the buttons on the remote control.

### [Off]:

You can use all of the buttons on the remote control.

### [User1]:

You can only use <POWER ON>, <STANDBY>, <INPUT>, <RECALL>, <MUTE>, <VOL +> and <VOL -> buttons on the remote control.

### [User2]:

You can only use <POWER ON> and <STANDBY> buttons on the remote control.

### [User3]:

Locks all the buttons on the remote control.

#### Note

- About how to reset the settings to defaults: "Initialization" (see page 83)

## PC auto setting

Sets the operational mode of the automatic position adjustment in the [Position] menu.

### [Off]:

Automatic position adjustment starts when <AUTO SETUP> is pressed on the remote control or automatic position adjustment is executed from the [Position] menu.

### [On]:

Other than remote control or menu operation, automatic position adjustment starts:

- When the display power is turned ON.
- When the input signal is switched.

## Off-timer function

Enables / disables Off timer function.

### [Enable]:

Enables the [Off-timer function].

### [Disable]:

Disables the [Off-timer function].

#### Note

- When [Disable] is set, the Off-timer is cancelled.

## Initial startup

Sets the power mode of the unit for when the power recovers from failure or after plugging off and in again.

### [Last memory]:

Power returns in as the same state as before the power interruption.

### [On]:

Power returns in power On.  
(Power Indicator: green)

### [Standby]:

Power returns in standby mode.  
(Power Indicator: red/orange)

#### Note

- When using multiple displays, [Standby] is preferred to be set in order to reduce a power load.

## Clock display

Sets to display / hide the clock.

### [Off]:

Hides the clock.

### [On]:

Displays the clock.

#### Note

- The clock is displayed at the lower left of the screen when <RECALL> button is pressed.
- When [Date and time] is not set, the clock is not displayed even when [Clock display] is [On]. (see page 70)

## Power on message(No activity power off)

Sets to show/hide [No activity power off] precautions when the power is turned on.

### [On]:

The warning precautions are shown when the power is turned on.

### [Off]:

The warning precautions are not shown when the power is turned on.

#### Note

- This setting is enabled only when [No activity power off] is [Enable] (see page 68).

## Power on message(Power management)

Sets to show/hide an information message that tells the power has been turned off by "Power management" function when the power is turned on.

### [On]:

The information is shown when the power is turned on.

### [Off]:

The information is not shown when the power is turned on.

### Note

- This setting is enabled only when "Power management" function is [On] (see page 67).

## POWER button lock

Sets the lock setting for <Power button (Unit)> (⏻/⏷).

### [On]:

<Power button (Unit)> operation is disabled.

### [Off]:

<Power button (Unit)> operation is enabled.

### Note

- This function is only for TH-55VF1HU.

## LAN control protocol

Select the LAN control protocol.

### [Protocol 1]:

Control with the Panasonic Display sequence.

### [Protocol 2]:

Control with the sequence that is compatible with Panasonic Projector.

### Note

- For PjLink and WEB browser control, the operation is possible regardless of the setting.
- When performing the command control with TCP/IP, select [Protocol 1].
- When operating the "Early Warning Software" or "Multi Monitoring & Control Software", select [Protocol 2].

## Information timing

Set up the informing manner for no signal or temperature rising.

### During RS-232C controls:

Warning or error message sent from the display automatically.

### During LAN controls:

Acquire the warning or error message from the display.

## 1 Select the item with ▲ ▼.

### Select the set point with ◀ ▶.

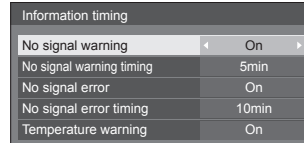

Information timing	
No signal warning	On
No signal warning timing	5min
No signal error	On
No signal error timing	10min
Temperature warning	On

### [No signal warning]

When set to [On], the display sends out the no signal warning.

### [No signal warning timing]

Set up the detecting time for no signal warning.  
(Range: 01 - 60, Interval: 1 minute)

### [No signal error]

When set to [On], the display sends out the no signal error.

### [No signal error timing]

Set up the detecting time for no signal error.  
(Range: 01 - 90, Interval: 1 minute)

- The warning of [No signal warning] and the error of [No signal error] are not sent when the no signal state is detected through any of the following functions:

[No signal power off], [HDMI power management], [DIGITAL LINK power management], [DVI-D1 power management], [DVI-D2 power management], [PC power management]  
(see page 67)

Setting Example:

- If there is no signal when [PC IN] is input, [PC power management] is activated first and the Display enters the standby mode.  
[No signal warning timing]: 5 minutes  
[No signal error timing]: 10 minutes  
[PC power management]: [On] (60 seconds)

### Note

- The [No signal error timing] cannot be set shorter than [No signal warning timing].
- With the USB input, the unit determines no signal is present when the USB memory is not connected to the USB terminal.
- In addition, even when a USB memory is connected, if there is no playable file, the unit determines no signal is present.

### [Temperature warning]

When set to [On], the display sends out the warning message.

## Initialization

When both main unit buttons and remote control buttons are disabled due to the [Button lock], [Controller user level] and [Controller ID function] (see page 55) settings, set all the values [Off] so that all the buttons are enabled again.

### Press <- (Unit)> together with <RETURN> and hold for more than 5 seconds.

[Shipping] is displayed and the lock is released when it disappears.

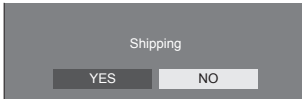

- Settings for [Button lock], [Controller user level] and [Controller ID function] will be back to [Off].

# Using Network Function

This unit has a network function and you can control the Display connected to the network using your computer.

## Necessary environment for computers to be connected

First of all, confirm your computer whether it has a wired LAN.

Before connecting the Display to the computer, be sure to check the following settings.

### Check 1: About LAN cable

- Is the cable connected properly?
- Use LAN cable that is compatible with category 5 or above.

### Check 2: LAN settings

#### Computer with a built-in LAN function

- Is your LAN switched on?

#### Computer without a built-in LAN function

- Is your LAN adapter recognized properly?
- Is your LAN adapter switched on?
- Install the LAN adapter driver beforehand.

For details on how to install the driver, refer to the instructions accompanying the LAN adapter.

#### About Web Browser

Web Browser is necessary to use WEB control.

- Compatible OS:  
Windows, Mac OS
- Compatible Web Browser:  
Internet Explorer 7.0 / 8.0 / 9.0 / 10.0 / 11.0 (Windows)  
Safari 4.x / 5.x / 6.x (Mac OS)

## Example of network connection

### Note

- To use the network function, set each item in [Network settings] and make sure to set [Network control] to [On].

(see page 70)

When it is set to [On], power indicator lights orange under the condition of power "Off" with remote control or <Power button (Unit)> (stand-by state).

### LAN Terminal connection

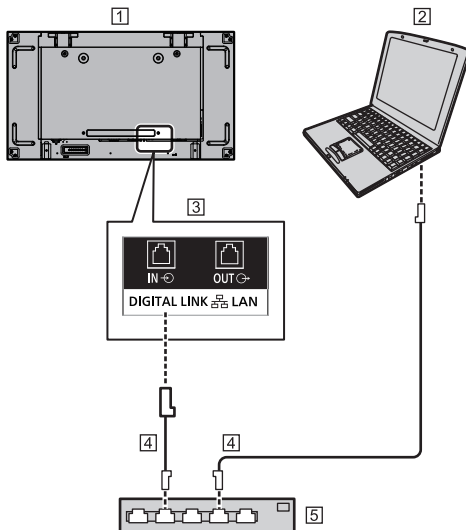

① Display (Back of the unit)

② PC

③ DIGITAL LINK / LAN Terminal

④ LAN cable (commercially available)

⑤ Hub or broadband router

### Note

- For LAN cable, use shielded cable, otherwise picture noise may be caused.
- Make sure the broadband router or hub supports 100BASE-TX.
- Touching the LAN Terminal with a statically charged hand (body) may cause damage to the device due to its discharge.

Do not touch the LAN Terminal or the metal part of the LAN cable.

- For instructions on connection, consult your network administrator.

## ■ DIGITAL LINK Terminal connection

A twisted pair cable transmitter, such as the Panasonic device that supports DIGITAL LINK output (ET-YFB100G, ET-YFB200G) uses twisted pair cables to transmit inputted video and audio signals, and these digital signals can be input to the Display via the DIGITAL LINK terminal.

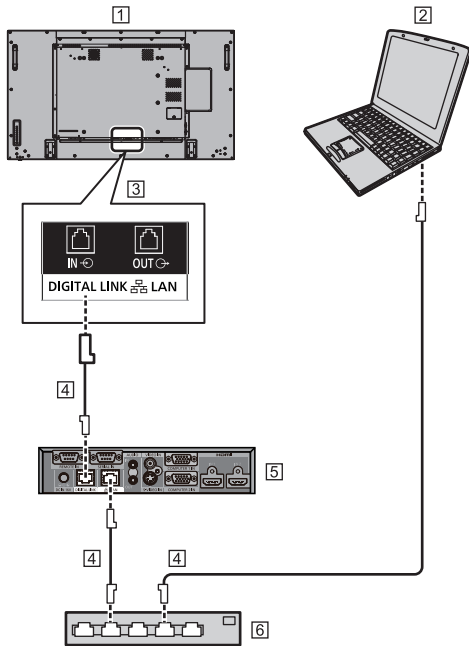

1 Display (Back of the unit)

2 PC

3 DIGITAL LINK / LAN Terminal

4 LAN cable (commercially available)

5 Example: Panasonic ET-YFB100G

6 Hub or broadband router

### Note

- When using a DIGITAL LINK connection, set each item in [Network settings]. (see page 70)

## Precautions for use while connecting with a twisted pair cable transmitter

### About installation / connection

- Ask the dealer or a qualified technician to carry out the cable wiring work for DIGITAL LINK connections. Insufficient wiring work may cause the inability to apply the cable transmission characteristics and cropped or fuzzy images and sounds.
- The transmission distance between the twisted pair cable transmitter and the device is normally up to 100 meters. When the transmitter supports [Long reach] communication method, the transmittable distance is up to 150 m. Please note that if exceeding the limit, video or audio may be interrupted, or malfunction may be caused during LAN communication. Furthermore, when connecting using [Long reach] communication method, depending on the specification of the transmitters, transmittable video signals or the distance may be limited.
- Do not use a hub between the twisted pair cable transmitter and the device.
- When connecting the Display using the twisted pair cable transmitter (receiver) of other manufacturer, do not use another twisted pair cable transmitter between the twisted pair cable transmitter of other manufacturer and this device. The images and sounds may be interrupted or become unstable.
- If possible, lay the cable extended and not coiled in order to minimize both external and internal noise.
- Lay out cables of the twist pair cable transmitter and this product away from other cables, especially from the power supply cable.
- When laying multiple cables, keep them together as close as possible running parallelly and not bundled.
- After laying the cable(s), check that the signal quality in [DIGITAL LINK status] is -12 dB or below.

### About Twisted pair cables

- Between the twisted pair cable transmitter and the device, use a LAN cable that conforms to the following conditions.
  - It meets or exceeds CAT5e standards
  - It is a straight cable
  - It is a shielded cable (with a connector)
  - It is a solid cable
- When laying the cable(s), use an instrument such as a cable tester or cable analyser and check whether the cable characteristics are CAT5e or above. When using a relay connector along the path, also include this in the measurements.
- Do not pull cables hard. Also, avoid bending or folding them forcefully.

## Other

- This device is compatible with Panasonic devices that support DIGITAL LINK output (ET-YFB100G, ET-YFB200G). For the twisted pair cable transmitter of other manufacturers, see the web site.  
([https://panasonic.net/cns/prodisplays/solutions/technology/digital\\_link/compatible\\_equipment/](https://panasonic.net/cns/prodisplays/solutions/technology/digital_link/compatible_equipment/))
- Panasonic has tested other manufacturers' devices according to our check items. This will not guarantee all the operations. For operation and performance defects caused by other manufacturers' devices, contact each manufacturer.

## Command control

Network function of the unit can control the unit in the same way as serial control from a network.

### Supported commands

Commands used in the serial control are supported.  
(see page 28)

## Control Command via LAN

The communication differs whether [Options] - [LAN control protocol] is set to [Protocol 1] or [Protocol 2].

The communication also differs depending on whether the WEB control administrator privileges password is set (Protect mode) or is not set (Non-protect mode).

Use the non-protect mode only when using a dedicated system which is not used by someone other than the network administrator.

Use the protect mode when operating within the intranet that may be used by a third party.

### Note

- Immediately after the command (received data) is sent, the network connection is automatically cut from the unit.

The above specification is adopted from the security stand point (to prevent manipulation of this product by a malicious third party). When sending commands in a row, request network connection each time before transmission.

## 1. When [LAN control protocol] is set to [Protocol 1].

Communicates using the display-specific protocol.

### ■ When the WEB control administrator privileges password has been set (Protect mode)

#### Connection method

- 1 Obtain the display's IP address and the port number (Default is 1024), and request connection to the display.

The IP address and the port number can be obtained from the following menus.

- IP address:  
[Setup] → [Network settings] → [LAN setup] or [Network status]
- Port number:  
[Setup] → [Network settings] → [LAN setup]
- For more detail of the settings, see page 71, 71.

- 2 The display responds.

Response data

Data part	Space	Mode	Space	Random number part	Last terminal symbol
[PDPCONTROL] (ASCII character string)	[ ] 0x20	[1] 0x31	[ ] 0x20	[zzzzzzzz] (ASCII code hex number)	(CR) 0x0d
10 bytes	1 byte	1 byte	1 byte	8 bytes	1 byte

Mode: 1 = Protect mode

- 3 Hash the following data with the MD5 algorithm, and generate a 32-byte hash value.

[zzzzzzzzyyyyy]

zzzzzzzz :

8-byte random number obtained in step 2

yyyyy :

Password of the WEB control administrator privileges user

- Default user name and password are as follows:  
User name: admin1  
Password: panasonic

### Command transmission method

Transmit in the following command format

Transmitted data

Header	Control symbol	Data part	Control symbol	Last terminal symbol
Hash value (see "Connection method")	(STX) 0x02	Control command (ASCII character string)	(ETX) 0x03	(CR) 0x0d
32 bytes	1 byte	Undefined	1 byte	1 byte

Received data

Control symbol	Data part	Control symbol	Last terminal symbol
(STX) 0x02	Control command (ASCII character string)	(ETX) 0x03	(CR) 0x0d
1 byte	Undefined	1 byte	1 byte

Error response

Error message	Last terminal symbol
"ERR1" : Undefined control command	(CR) 0x0d
"ERR2" : Out of parameter range	
"ERR3" : Busy status or reception invalid period	
"ERR4" : Timeout or reception invalid period	
"ERR5" : Wrong data length	
"PDPCONTROL ERRA" : Mismatching of password	(CR) 0x0d
4 bytes or 15 bytes	

### ■ When the WEB control administrator privileges password has not been set (Non-protect mode)

#### Connection method

- 1 Obtain the display's IP address and the port number (Default is 1024), and request connection to the display.  
The IP address and the port number can be obtained from the following menus.
  - IP address:  
[Setup] → [Network settings] → [LAN setup] or [Network status]
  - Port number:  
[Setup] → [Network settings] → [LAN setup]
 For more detail of the settings, see page 71, 71.

- 2 The display responds.

Response data

Data part	Space	Mode	Last terminal symbol
[PDPCONTROL] (ASCII character string)	[ ] 0x20	[0] 0x30	(CR) 0x0d
10 bytes	1 byte	1 byte	1 byte

Mode:0 = Non-protect mode

#### Command transmission method

Transmit in the following command format

Transmitted data

Control symbol	Data part	Control symbol	Last terminal symbol
(STX) 0x02	Control command (ASCII character string)	(ETX) 0x03	(CR) 0x0d
1 byte	Undefined	1 byte	1 byte

Received data

Control symbol	Data part	Control symbol	Last terminal symbol
(STX) 0x02	Control command (ASCII character string)	(ETX) 0x03	(CR) 0x0d
1 byte	Undefined	1 byte	1 byte

Error message	Last terminal symbol
“ERR1” : Undefined control command	(CR) 0x0d
“ERR2” : Out of parameter range	
“ERR3” : Busy status or reception invalid period	
“ERR4” : Timeout or reception invalid period	
“ERR5” : Wrong data length	
4 bytes	1 byte

## 2. When [LAN control protocol] is set to [Protocol 2].

Communicates with the same protocol as that of a Panasonic projector

### ■ When the WEB control administrator privileges password has been set (Protect mode)

#### Connection method

1 Obtain the display's IP address and the port number (Default is 1024), and request connection to the display.

The IP address and the port number can be obtained from the following menus.

- IP address:  
[Setup] → [Network settings] → [LAN setup] or [Network status]
- Port number:  
[Setup] → [Network settings] → [LAN setup]
- For more detail of the settings, see page 71, 71.

2 The display responds.

Response data

Data part	Space	Mode	Space	Random number part	Last terminal symbol
[NTCONTROL] (ASCII character string)	[ ] 0x20	[1] 0x31	[ ] 0x20	[zzzzzzzz] (ASCII code hex number)	(CR) 0x0d
9 bytes	1 byte	1 byte	1 byte	8 bytes	1 byte

Mode: 1 = Protect mode

3 Hash the following data with the MD5 algorithm, and generate a 32-byte hash value.

[xxxxxx:yyyyy:zzzzzzzz]

xxxxxx :

WEB control administrator privileges user name

yyyyy :

Above administrator privileges user password

- Default user name and password are as follows:

User name: admin1

Password: panasonic

zzzzzzzz :

8-byte random number obtained in step 2



### Command transmission method

Transmit in the following command format

Transmitted data

Header			Data part	Last terminal symbol
Hash value (see "Connection method")	'0' 0x30	'0' 0x30	Control command (ASCII character string)	(CR) 0x0d
32 bytes	1 byte	1 byte	Undefined	1 byte

Received data

Header		Data part	Last terminal symbol
'0' 0x30	'0' 0x30	Control command (ASCII character string)	(CR) 0x0d
1 byte	1 byte	Undefined	1 byte

Error response

Error message	Last terminal symbol
"ERR1" : Undefined control command	(CR) 0x0d
"ERR2" : Out of parameter range	
"ERR3" : Busy status or reception invalid period	
"ERR4" : Timeout or reception invalid period	
"ERR5" : Wrong data length	
"ERRA" : Mismatching of password	
4 bytes	1 byte

### ■ When the WEB control administrator privileges password has not been set (Non-protect mode)

#### Connection method

1 Obtain the display's IP address and the port number (Default is 1024), and request connection to the display.

The IP address and the port number can be obtained from the following menus.

- IP address:  
[Setup] → [Network settings] → [LAN setup] or [Network status]
- Port number:  
[Setup] → [Network settings] → [LAN setup]

For more detail of the settings, see page 71, 71.

2 The display responds.

Response data

Data part	Space	Mode	Last terminal symbol
[NTCONTROL] (ASCII character string)	[ ] 0x20	[0] 0x30	(CR) 0x0d
9 bytes	1 byte	1 byte	1 byte

Mode:0 = Non-protect mode

#### Command transmission method

Transmit in the following command format

Transmitted data

Header		Data part	Last terminal symbol
'0' 0x30	'0' 0x30	Control command (ASCII character string)	(CR) 0x0d
1 byte	1 byte	Undefined	1 byte

Received data

Header		Data part	Last terminal symbol
'0' 0x30	'0' 0x30	Control command (ASCII character string)	(CR) 0x0d
1 byte	1 byte	Undefined	1 byte

Error message	Last terminal symbol
"ERR1" : Undefined control command	(CR) 0x0d
"ERR2" : Out of parameter range	
"ERR3" : Busy status or reception invalid period	
"ERR4" : Timeout or reception invalid period	
"ERR5" : Wrong data length	
4 bytes	1 byte

**Note**

- With some of the commands, a part of character string of the transmitted data may not be included in the received data.
- Consult your local Panasonic dealer for detail instructions on command usage.

For more details, visit the following web site.

<https://panasonic.net/cns/prodisplays/>

**PJLink protocol**

The unit's Network function is compatible with PJLink Class 1. The following operations can be performed from a computer when PJLink protocol is used.

- Setting the Display
- Querying the Display status

**Supported commands**

The commands to control the unit with PJLink protocol are as follows.

Command	Control
POWER	Power control 0: Standby 1: Power On
POWER?	Power status query 0: Standby 1: Power On
INPT	Input switch 11: PC IN input (PC) 21: COMPONENT/RGB IN input (COMPONENT) 22: VIDEO input (VIDEO) 31: HDMI input (HDMI) 32: DisplayPort input (DisplayPort) 33: DIGITAL LINK input (DIGITAL LINK) 34: DVI-D IN 1 input (DVI-D1) 35: DVI-D IN 2 input (DVI-D2) 41: USB input (USB)
INPT?	Input switch query 11: PC IN input (PC) 21: COMPONENT/RGB IN input (COMPONENT) 22: VIDEO input (VIDEO) 31: HDMI input (HDMI) 32: DisplayPort input (DisplayPort) 33: DIGITAL LINK input (DIGITAL LINK) 34: DVI-D IN 1 input (DVI-D1) 35: DVI-D IN 2 input (DVI-D2) 41: USB input (USB)

Command	Control
AVMT	Shutter control 10: Picture On (picture mute deactivated) 11: Picture Off (picture on mute) 20: Audio On (audio mute deactivated) 21: Audio Off (audio on mute) 30: Shutter mode Off (picture and audio mute deactivated) 31: Shutter mode On (picture and audio on mute)
AVMT?	Shutter control query 11: Picture Off (picture on mute) 21: Audio Off (audio on mute) 30: Shutter mode Off (picture and audio mute deactivated) 31: Shutter mode On (picture and audio on mute)
ERST?	Error status query First byte: 0 Second byte: 0 Third byte: 0 Fourth byte: 0 Fifth byte: 0 Sixth byte: Other error. 0 or 2. <ul style="list-style-type: none"> <li>• Meaning of 0, 2.  0: Error is not detected,  2: Error</li> </ul>
LAMP?	Lamp status query Not supported
INST?	Input switch list query 11: PC IN input (PC) 21: COMPONENT/RGB IN input (Component) 22: VIDEO input (VIDEO) 31: HDMI input (HDMI) 32: DisplayPort input (DisplayPort) 33: DIGITAL LINK input (DIGITAL LINK) 34: DVI-D IN 1 input (DVI-D1) 35: DVI-D IN 2 input (DVI-D2) 41: USB input (USB)
NAME?	Display name query The name selected in [Network settings] - [Display name] is returned.
INF1?	Manufacturer name query Returns "Panasonic".

Command	Control
INF2?	Model name query Returns "55VF1HU" / "55VF1HW". (Example: 55-inch VF1HU / VF1HW model)
INFO?	Other information query Returns version number.
CLSS?	Class information query Returns "1".

### PJLink security authentication

The password used for PJLink is the same as the password set for the WEB control. (see page 93)

When using PJLink without security authorization, set use without the password (blank) for administrator privileges and the password for user privileges of Web browser control.

- Concerning the specification of PJLink, see the web site of Japan Business Machine and Information System Industries Association (JBMA) below:  
<http://pjlink.jbma.or.jp/english/index.html>

### Early Warning Software

This unit supports "Early Warning Software" which monitors the statuses of devices (projectors or flat-panel displays) connected to an intranet, reports failures of devices and gives advance warning by detecting a predicted abnormality.

The maximum number of devices that can be registered to monitor differs according to the type of license. Up to 2048 devices can be registered and used for free for a maximum of 90 days after the installation to PC has completed.

- For more details, visit the following web site.

(<https://panasonic.net/cns/prodisplays/products/et-swa100/index.html>)

### Multi Monitoring & Control Software

This unit supports "Multi Monitoring & Control Software" which monitors and controls devices (projectors or flat-panel displays) connected to an intranet.

- For details, see the following website.

(<https://panasonic.net/cns/prodisplays/download/software/index.html>)

### Video Wall Manager

This unit supports the "Video Wall Manager" software which adjusts multiple displays simultaneously or separately on one computer without rearranging cables.

- For more details, visit the following web site.

(<https://panasonic.net/cns/prodisplays/download/software/index.html>)

# Connecting with LAN

## Note

- To use the network function, set each item in [Network settings] and be sure to set [Network control] to [On]. (see page 70)

## Computer operation

- 1 Turn on the computer.
- 2 Make the network setting according to your system administrator.

When the Display settings are the default settings (see page 71), the computer can be used with the following network settings.

IP address	192.168.0.9
Subnet mask	255.255.255.0
Gateway	192.168.0.1

# Using Web Browser Control

You can use a Web browser to control the unit and set up a network and password.

## Before Using Web Browser Control

To use the Web browser control, the unit and computer set ups are required.

### ■ About Web Browser

Set each item in [Network settings] and be sure to set [Network control] to [On]. (see page 70)

### ■ Computer Setup

Disable the proxy server settings and enable JavaScript.

- The setting procedure differs depending on the software version.

Please refer to description in HELP, etc. of the software.

### (Windows)

Windows 7 is used as an example.

#### Disable proxy server settings

- 1 Display [Internet Properties] window.  
Click [Start] - [Control Panel] - [Network and Internet] - [Internet Options].
  - If the on screen display looks different, please set [View by:] to [Category].
- 2 Click the [Connections] tab and then [LAN Settings].
- 3 Deselect the [Use automatic configuration script] and [Use a proxy server for your LAN] boxes.
- 4 Click [OK].

#### Enable JavaScript

- 1 Display [Internet Properties] window.  
Click [Start] - [Control Panel] - [Network and Internet] - [Internet Options].
  - If the on screen display looks different, please set [View by:] to [Category].
- 2 Set the security level on the [Security] tab to [Default Level]. Alternatively enable [Active scripting] from the [Custom Level] button.

### (Macintosh)

#### Disable proxy server settings

- 1 From the [Safari] menu, click [Preferences].  
General screen is displayed.
- 2 From the [Advanced] tab, click the [Change Settings...] button next to [Proxies].  
Click [Proxies] and set up a proxy server.
- 3 Deselect the [Web Proxy] and [Automatic Proxy Configuration] boxes.
- 4 Click [Apply Now].

## Enable JavaScript

- 1 Display [Security] of Safari.
- 2 Select [Enable JavaScript] under [Web content].

## Access from Web Browser

Access to the TOP screen of the Web browser control using a Web browser.

- 1 Start your Web browser.
- 2 Enter the IP address set with the [LAN setup] of the unit.  
(see page 71)

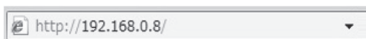

- 3 Enter the user name and password when the Authentication screen is displayed.

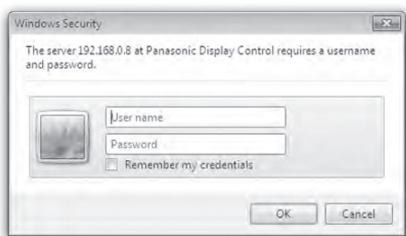

- 4 Click [OK].

After logged in, the TOP screen of the Web Browser Control is displayed.

### Note

- The password used here is the same password used for command control and the PJLink security authentication.
- Default user name and password are as follows:  
User name: user1 (user rights), admin1 (administrator rights)  
Password: panasonic  
Change password first.
- The password can be changed on the Password Setup screen after logging in (see page 95). Log in with administrator privileges to change this.
- When using "Crestron Connected™" (see page 97), log in with the administrator rights.
- Under no circumstances, Panasonic Corporation or its associated companies will ask customers their password directly.  
Even if you are asked directly, please do not reveal your password.

## Operating with Web Browser

### ■ Description of each section

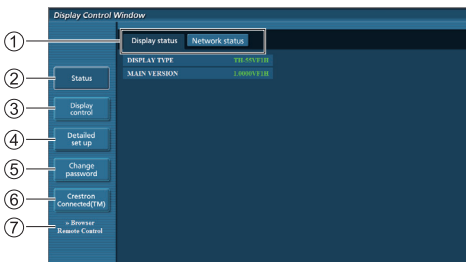

- 1 **Page tab**  
Click these to switch pages.
- 2 **[Status]**  
Click this item, and the status of the Display is displayed.
- 3 **[Display control]**  
Click this item to display the Display control page.
- 4 **[Detailed set up]**  
Click this item to display the advanced settings page.
- 5 **[Change password]**
- 6 **[Crestron Connected™]**  
Click this item to display the Crestron Connected™ operation page.
- 7 **[Browser Remote Control]**  
Click this item to display the Browser Remote Control on the WEB browser, which is the same as the supplied remote control.

### Display status page

Click [Status], then [Display status] to display the Status information page.

This page displays the Display statuses established for the items shown below.

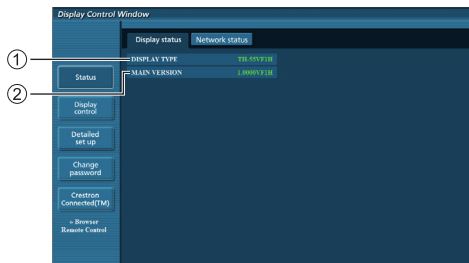

- ① Displays the type of Display.
- ② Displays the firmware version of the Display main unit.

## Network status page

Click [Status], then [Network Status] to display the Status information page.

Displays the current configuration information of the network.



- 1 Displays the configuration details of wired LAN.

## Basic control page

To move from another page, click [Display control], then [Basic control].



- 1 Power On/Off control
- 2 Use these to select the input signals
- 3 AUDIO mute
- 4 Switches aspect mode

## Detail control page

Click [Display control], then [Advanced control] to display the Detail control page.

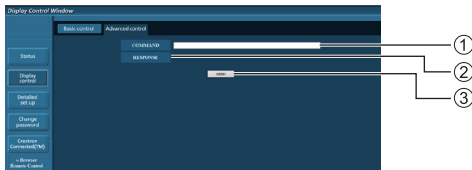

- 1 Enter a command. Use the same command used for the serial control.
- 2 Response from the unit is displayed.
- 3 Command is sent and run.

### Note

- After the settings are changed, it may take a while till the display status is displayed.

## Change Password page

Click [Change password].

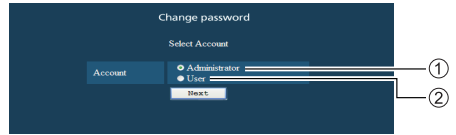

- 1 Administrator
- 2 User

### Administrator mode

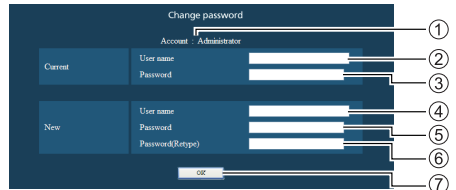

- 1 Account
- 2 Current user name input field
- 3 Current password input field
- 4 New user name input field
- 5 New password input field
- 6 New password input field (re-enter for confirmation)
- 7 Button for executing password change

### User account

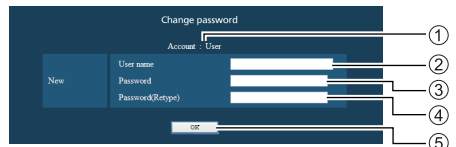

- 1 Account
- 2 New user name input field
- 3 New password input field
- 4 New password input field (re-enter for confirmation)
- 5 Button for executing password change

## ■ User mode

A user can change password only.

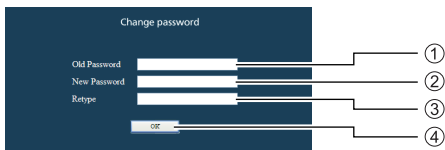

- ① Current password input field
- ② New password input field
- ③ New password input field (re-enter for confirmation)
- ④ Button for executing password change

### Note

- Up to 16 alphanumeric characters can be used for a password.
- When changing the administrator account, both “Current user name” and “Current password” are required.

## Network config page

When connecting by logging in with administrator privileges, you can make detailed settings for network related to display.

## ■ LAN settings

### 1 Click [Detailed set up] in the menu.

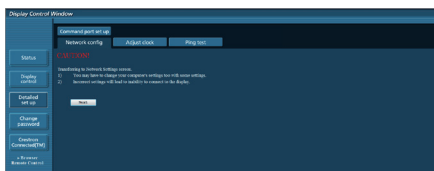

### 2 Click [Next].

The settings window appears, showing the current settings.

- To change the LAN settings, click [Change].
- To return to the previous window, click [Back].

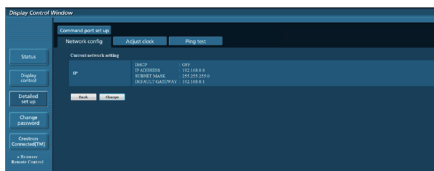

### 3 Complete the detailed settings and click [Next].

Setting contents here are the same as the address information contents set for the [LAN setup] menu of the Display.

After all required items have been entered, click [Next]. Then, a confirmation window appears.

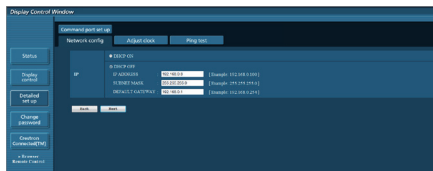

### 4 Click [Submit].

The settings will be registered.

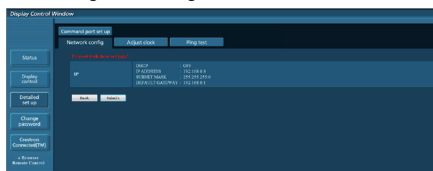

### Note

- Changing the setting of LAN while connected with LAN might disconnect the connection.

## Adjust clock page

Click [Detailed set up], then [Adjust clock] to display the Adjust clock page.

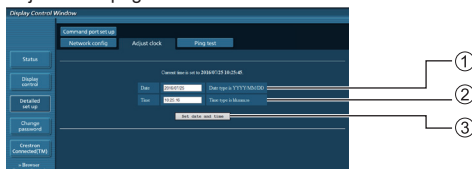

- ① New date field
- ② New time field
- ③ Button to update time and date settings

### Note

- Date and time is displayed as [- -] when they are not set.
- When [Network control] is set to [On] and it is in standby mode, date and time display will be blank and they cannot be set.
- If the time becomes incorrect immediately after setting the correct time, contact the dealer where you bought the Display.

## Ping test page

This page makes it possible to check whether the network is connected to the DNS server, etc.

Click [Detailed set up], then [Ping test] to display the Ping test page.

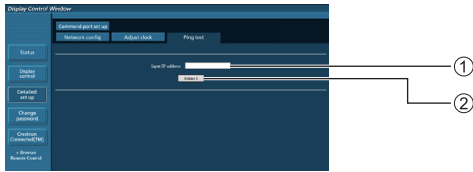

- ① Enter the IP address of the server to be tested.
- ② Button for conducting the test

Display which appears when the connection was successful.

```
PING 192.168.0.10 (192.168.0.10): 56 data bytes
64 bytes from 192.168.0.10: seq=0 ttl=128 time=2.271 ms
64 bytes from 192.168.0.10: seq=1 ttl=128 time=2.078 ms
64 bytes from 192.168.0.10: seq=2 ttl=128 time=2.017 ms
64 bytes from 192.168.0.10: seq=3 ttl=128 time=1.845 ms

--- 192.168.0.10 ping statistics ---
4 packets transmitted, 4 packets received, 0% packet loss
round-trip min/avg/max = 1.845/2.052/2.271 ms
```

Display which appears when the connection failed.

```
PING 192.168.0.15 (192.168.0.15): 56 data bytes
--- 192.168.0.15 ping statistics ---
4 packets transmitted, 0 packets received, 100% packet loss
```

## Command port set up page

Set the port number to be used with command control.

Click [Detailed set up], then [Command port set up] to display the Command port set up page.

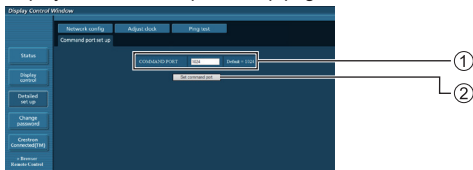

- ① Input the port number to be used with command control.
- ② Setting update button.

## [Browser Remote Control]

It is possible to operate the display with the operation buttons displayed on the WEB browser.

Click [Browser Remote Control].

The [Browser Remote Control] screen is displayed.

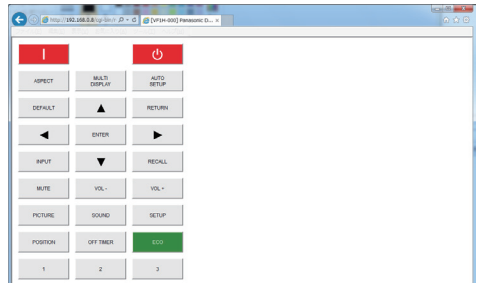

## Browser Remote Control

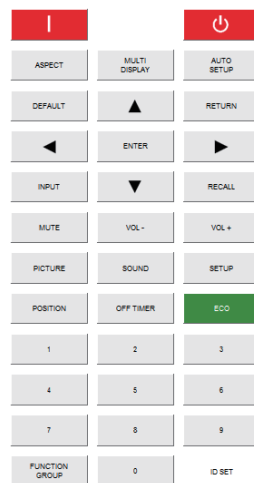

The Browser Remote Control can be operated in the same way as the supplied remote control.

For allocation / function of each button, see page 32.

To finish the Browser Remote Control, click

[Display Control Window] or exit the browser.



## Note

- To use this function, set [Network control] to [On]. (see page 70)
- The Browser Remote Control can also be displayed by entering "http://xxx.xxx.xxx.xxx/remotec/" in the WEB browser URL entry field.
  - xxx.xxx.xxx.xxx is the IP address set for this display.
- The button long press operation is invalid.
- [Options] menu (see page 78) cannot be displayed.
- The restriction for the remote control button operation set for [Options] - [Controller user level] (see page 81) does not apply.
- Avoid operating the multiple Browser Remote Control simultaneously.
- The same operations are applicable to both administrator privileges and user privileges.
- If the Browser Remote Control screen is not displayed, consult your network administrator.
- The screen may turn white for a moment when updating the Browser Remote Control screen, but it is not a malfunction.
- While operating the Browser Remote Control, do not operate the unit by other methods such as WEB control screen, remote control and external control command.
- If the "Back" or "Forward" functions on the WEB browser is used, the screen display may be abnormal. In this case, the subsequent operations are not guaranteed. Update the WEB browser.

## Using Web Browser Control

### Crestron Connected™

#### (Crestron Connected™ operation screen)

You can monitor or control the Display using "Crestron Connected™".

If Adobe Flash Player is not installed in your computer, or if the browser does not support Flash, this page does not appear. In this case, return to the previous page by clicking [Back] in the operation page.

- Operation page

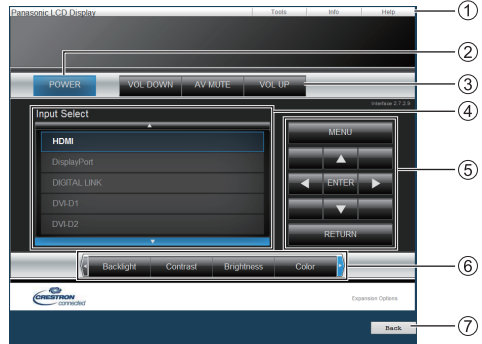

#### ① [Tools], [Info], [Help]

Switches the pages for tools, information, help using the tab.

#### ② [POWER]

Switches between on and off of the power.

#### ③ [VOL DOWN], [AV MUTE], [VOL UP]

Sets the volume, AV mute.

When the power of the Display is turned off, these operations are not available.

#### ④ [Input Select]

Sets the input selection.

When the power of the Display is turned off, this operation is not available.

#### ⑤ Operation buttons on the menu screen

Operates on the menu screen.

#### ⑥ Image quality adjustments

Operate items related to image quality.

#### ⑦ [Back]

Returns to the previous page.

- [Tools] page

Click [Tools] on the operation page.

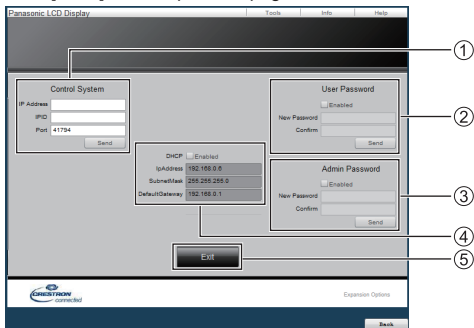

① **[Control System]**

Sets the information required for the communication with the controller that is connected to the Display.

② **[User Password]**

Sets the password for the user rights in the operation page of "Crestron Connected™".

③ **[Admin Password]**

Sets the password for the administrator rights in the operation page of "Crestron Connected™".

④ **[Network Status]**

Displays the setting of LAN.

- [DHCP]
- [IpAddress]
- [SubnetMask]
- [DefaultGateway]

Displays the value in the current setting.

⑤ **[Exit]**

Returns to the operation page.

**Note**

- When you monitor or control the Display using "Crestron Connected™", set [Crestron Connected™] to [On] in the [Network settings] menu.

- [Info] page

Click [Info] on the operation page.

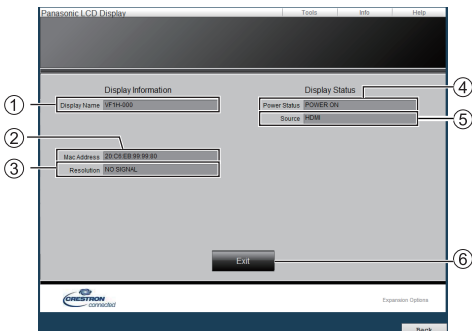

① **[Display Name]**

Displays the name of the Display.

② **[Mac Address]**

Displays the MAC address.

③ **[Resolution]**

Displays the resolution of the Display.

④ **[Power Status]**

Displays the status of the power.

⑤ **[Source]**

Displays the selected video input.

⑥ **[Exit]**

Returns to the operation page.

- [Help] page

Click [Help] on the operation page.

The [Help Desk] screen is displayed.

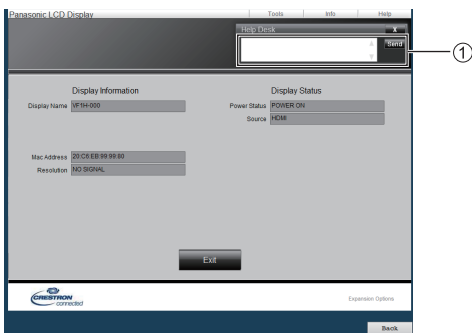

① **[Help Desk]**

Sends or receives messages to the administrator who uses "Crestron Connected™".

# USB media player

## Function description

The [USB media player] displays still pictures and motion pictures saved in a USB memory by inserting the USB memory device into the display unit.

### Note

- To use this function, set [USB media player] to [Enable] in [Setup] - [USB media player settings]. (see page 73)

- When using the "Single Media Player", the unit prevents a black screen from appearing at the switching timing of still pictures or motion pictures. Note the following restrictions.

- (1) A black screen appears when switching a motion picture codec.
- (2) A black screen may appear or images may be disturbed when switching to motion pictures of a different frame rate or aspect ratio.

If an angle of view for something other than for 16:9 is used, images may be disturbed near the end of playback.

Inserting a black screen (approx. 2 sec.) at the switching timing for all the motion pictures can avoid image disturbance in above (2).

([USB media player settings] (see page 73))

- Using the content list delivery function of the Multi Monitoring & Control Software (see page 91), content (still/motion pictures) played back on a USB media player and the playback list can be delivered.

(Still pictures that can be delivered are only jpg files.)

For details, refer to the manual of Multi Monitoring & Control Software.

- The multi display mode is not available with USB input.

### Single Media Player

Files are played by a single unit.



### Multi Media Player

Connecting more than one unit using LAN cables plays back files in the USB memory simultaneously.

One of the multiple units becomes the parent, and the others are children. The two-unit configuration example is shown below.

For LAN connection, see "Network environment (Multi Media Player only)" (see page 105).

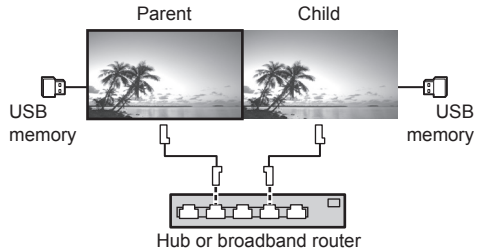

### Note

- For Multi Media Player, one USB memory device is required for one unit.
- For Multi Media Player, the parent requires both "scenario.dat" and "filelist.dat", and the child requires "filelist.dat" only.
- Describe "GroupID:G01" without changing characters other than numbers (2-digit description required). Without description, the Multi Media Player does not function.
- When motion pictures are played on the multi media player, a black screen may be displayed for a certain period of time at the switching timing of motion pictures.
- Pictures in the USB memory cannot be displayed via a daisy chain connection with the DIGITAL LINK IN/OUT terminal.

## Preparation

### ■ Supported device

- Commercially available USB memory devices are supported. (Those with security functions are not supported. Operation is not guaranteed.)
- USB memory devices other than those formatted in FAT16 or FAT32 cannot be used.
- Up to 32 GB of USB memory in size are supported.
- Only single partition configuration is supported.

### ■ Preparation

Prepare the following files in the USB memory for the media player.

- Play file
- Scenario (as necessary)
- File list (as necessary)

#### Note

- Delete files irrelevant to playback from the USB memory device.
- Up to 999 files can be played back. If more than the maximum number of files are present, some files are not played back.

An error is displayed by the scenario file check (see page 73).

- Up to 999 lines of Scenario files are valid.

### ■ Play file

The unit's Media Player supports the formats below.

#### Still pictures

Extension	Format	Limitation
jpg/ jpeg/ jpe	JPEG	Maximum number of pixels: 4096 × 4096 (supports baseline only) YUV format: supports YUV444, YUV442 and YUV440 Colour mode: supports RGB only
bmp	Windows Bitmap	Maximum number of pixels: 4096 × 4096 (1 bit, 4 bits, 8 bits, 24 bits) Following formats are not supported: Run-length encoding, bit field, top-down, transparent data

#### Motion pictures

Extension	Codec	
	Video	Audio
avi	MPEG4 AVC/ H.264 MPEG-4 Visual	MPEG-1/2 Audio Layer- 3(MP3) Linear PCM

mkv	MPEG4 AVC/ H.264 MPEG-4 Visual	MPEG-1/2 Audio Layer-3 Linear PCM AAC HE-AAC
asf/wmv	MPEG4 AVC/ H.264 MPEG-4 Visual VC-1 Advanced VC-1 Simple&Main	MPEG-1/2 Audio Layer-3 WMA Standard WMA9/10Pro
ts/mts	MPEG4 AVC/ H.264 MPEG-4 Visual	MPEG-1/2 Audio Layer-3 HE-AAC
mp4	MPEG4 AVC/ H.264 MPEG-4 Visual	MPEG-1/2 Audio Layer-3 AAC HE-AAC
3gp	MPEG4 AVC/ H.264 MPEG-4 Visual	AAC HE-AAC
mov	MPEG4 AVC/ H.264 MPEG-4 Visual	MPEG-1/2 Audio Layer-3 Linear PCM AAC HE-AAC
flv/f4v	MPEG4 AVC/ H.264	MPEG-1/2 Audio Layer-3 AAC Linear PCM

#### Limitation

Video	
Codec	
MPEG-4 AVC/ H.264 High Profile	Maximum resolution: 1920 × 1080 Maximum frame rate: 30fps (progressive) Maximum bit rate: 30Mbps • Level 4.2 or less • MVC (Multi-view Video Coding) unsupported
MPEG-4 Visual Simple Profile and Advanced Simple Profile	Maximum resolution: 1920 × 1080 Maximum frame rate: 30fps (progressive) Maximum bit rate: 30Mbps • Only 1 warp-point GMC supported • Data Partitioning is not supported.
VC-1 Simple Profile and Main Profile	Maximum resolution: 1920 × 1080 Maximum frame rate: 30fps (progressive) Maximum bit rate: 20Mbps
VC-1 Advanced Profile	Maximum resolution: 1920 × 1080 Maximum frame rate: 24fps (progressive), 30fps (interlace) Maximum bit rate: 30Mbps • Level: L3 or less supported

Audio		
Codec	Sampling frequency (kHz)	Bit rate (kbps)
MP3	8/10.025/12/16/	8 – 320
WMA Standard	22.05/24/32/44.1/48	32 – 384
WMA 9		32 – 384
WMA 10 Pro		32 – 384
LPCM		64 – 1536
		Supported quantization bit: 8/16/24/32
AAC		8 – 1440
HE-AAC		8 – 256

#### Note

- Maximum size per one file is 2 GB.
- Some files may not be played back even if their formats are supported as described here.
- Files protected by Digital Rights Management (DRM) cannot be played back.
- Make sure that both audio codec and video codec are supported. If the audio codec of motion picture file is incompatible in format, the pictures may not be correctly displayed. In addition, files which contain only audio cannot be played back.
- Playback is not possible if the maximum bit rate specified in the codec Profile or Level is exceeded. Also, depending on the USB memory device, playback may be impossible even if the bit rate is less than the indicated maximum bit rate.
- A part of information of still pictures/motion pictures can be confirmed on the computer accessible to the target files.
- Example of an operation

#### (Windows)

1. Right-click the file, and then click [Properties].
2. Click the [Details] tab.

#### (Macintosh)

1. Control-click the file, and then click [Get Info].
2. Click [Details].

## ■ Scenario

The play order and time can be specified for a play file. Save under the name (one-byte alphabetical characters) “scenario.dat” immediately below root in USB memory.

- Save files as UTF-8N format.
- 1 to 999 lines can be specified for Scenario.

## ■ File list

It is a list of play files.

Save under the name (one-byte alphabetical characters) “filelist.dat” immediately below root in USB memory.

- Save files as UTF-8N format.

## ■ Scenario- / File list-associated terms

### File name

It is the name of a play file.

A file name needs to include its extension.

Example:

```
introduction.jpg
Contents_video01.wmv
```

- Enter the extension of a file name using one-byte alphanumeric characters.

### File definition

It is a file definition that is shared among scenarios and files.

```
PHOTO_xxx: still image file definition
VIDEO_xxx: moving image file definition
```

- The “xxx” portion can be set from 001 to 999.
- Enter a file definition using one-byte alphanumeric characters.

### Play time

It is the play time of a file.

Play time can be specified from 3 seconds to 24 hours. (Unit: second)

Example:

```
10: 10 seconds
86400: 24 hours
10.5: 10.5 seconds
```

It can be set down to one-tenth (1/10) of a second using a decimal point (full stop).

Play time is omissible.

For still images, a file will be played for the period of time that you selected in [USB media player settings] - [Slide show duration]. (see page 73)

For moving images: a file will be played for the duration of the play time of the file.

- Enter play time using one-byte numeric characters.
- When playing back large sized files, if you set the playing back duration short, it may not be played back properly, for example, noise appears on the screen.

In that case, set the playing back duration longer (10 seconds or longer).

### Group ID (for Multi Media Player)

It is an ID used for grouping on a network during Multi Media Player conditions.

GroupID:Gxx : Group xx

- The "xx" portion can be set from 01 to 10.
- Enter a group ID using one-byte alphanumeric characters.

#### Note

- "UTF-8N": UTF-8 encoding without BOM. Notepad for windows doesn't support this encoding. Please use another editor supported UTF-8 encoding without BOM.

## Playing back the files

### ■ Example of setting in each mode

#### Single Media Player (Type 1)

Files will be played in the order in which their names appear in USB memory.

##### Scenario and file list

Scenario:  
Unnecessary

File list:  
Unnecessary

#### Setting example

##### USB memory contents

```
├─ 001_Introduction.jpg
├─ 002_Contents_Video1.wmv
├─ 003_Contents_Video2.wmv
├─ 004_Contents_Video3.wmv
```

##### Play contents

For the above setting example, the following contents will be played on repeat (loop).

1. 001\_Introduction.jpg (\*1)
2. 002\_Contents\_Video1.wmv (\*2)
3. 003\_Contents\_Video2.wmv (\*2)
4. 004\_Contents\_Video3.wmv (\*2)

\*1: Played for the duration set in [Slide show duration].

\*2: Played for the duration of the play time of the file.

#### Single Media Player (Type 2)

Files will be played in the order they were listed in a scenario.

##### Scenario and file list

Scenario:  
Enter [File name: Play time].

File list:  
Unnecessary

#### Setting example

##### USB memory contents

```
├─ scenario.dat
├─ Introduction.jpg
├─ Contents_Video1.wmv
├─ Contents_Video2.wmv
├─ Contents_Video3.wmv
```

##### scenario.dat

```
Introduction.jpg:10
Contents_Video1.wmv:10
Contents_Video2.wmv:20
Contents_Video3.wmv:
```

##### Play contents

For the above setting example, the following contents will be played on repeat (loop).

1. Introduction.jpg (10 seconds)
2. Contents\_Video1.wmv (10 seconds)
3. Contents\_Video2.wmv (20 seconds)
4. Contents\_Video3.wmv (Played for the duration of the play time of the file)

#### Single Media Player (Type 3)

Files will be played in the order they were listed in a scenario.

##### Scenario and file list

Scenario:  
Enter [File definition: Play time].

File list:  
Enter [File definition: File name].

## Setting example

### USB memory contents

```
└─ filelist.dat
  └─ scenario.dat
    └─ Introduction.jpg
      └─ Contents_Video1.wmv
        └─ Contents_Video2.wmv
          └─ Contents_Video3.wmv
```

### scenario.dat

```
PHOTO_001:10
VIDEO_001:10
VIDEO_002:20
VIDEO_003:
```

### filelist.dat

```
PHOTO_001:Introduction.jpg
VIDEO_001:Contents_Video1.wmv
VIDEO_002:Contents_Video2.wmv
VIDEO_003:Contents_Video3.wmv
```

### Play contents

For the above setting example, the following contents will be played on repeat (loop).

1. Introduction.jpg (10 seconds)
2. Contents\_Video1.wmv (10 seconds)
3. Contents\_Video2.wmv (20 seconds)
4. Contents\_Video3.wmv (Played for the duration of the play time of the file)

## Multi Media Player

Files will be played in the order they were listed in the scenario for Parent.

### Scenario and file list

#### Parent side

Scenario:

Enter [File definition: Play time].

File list - The first line:

Enter [Group ID].

File list - The second and subsequent lines:

Enter [File definition: File name].

#### Child side

Scenario:

Unnecessary

File list - The first line:

Enter [Group ID].

File list - The second and subsequent lines:

Enter [File definition: File name].

## Setting example

### Parent side

#### USB memory contents

```
└─ filelist.dat
  └─ scenario.dat
    └─ L_Introduction.jpg
      └─ L_Contents_Video1.wmv
        └─ L_Contents_Video2.wmv
          └─ L_Contents_Video3.wmv
```

### scenario.dat

```
PHOTO_001:10
VIDEO_001:10
VIDEO_002:20
VIDEO_003:
```

### filelist.dat

```
GroupID:G01
PHOTO_001:L_Introduction.jpg
VIDEO_001:L_Contents_Video1.wmv
VIDEO_002:L_Contents_Video2.wmv
VIDEO_003:L_Contents_Video3.wmv
```

### Child side

#### USB memory contents

```
└─ filelist.dat
  └─ R_Introduction.jpg
    └─ R_Contents_Video1.wmv
      └─ R_Contents_Video2.wmv
        └─ R_Contents_Video3.wmv
```

### filelist.dat

```
GroupID:G01
PHOTO_001:R_Introduction.jpg
VIDEO_001:R_Contents_Video1.wmv
VIDEO_002:R_Contents_Video2.wmv
VIDEO_003:R_Contents_Video3.wmv
```

## Play contents

For the above setting example, the following contents will be played on repeat (loop).

### Parent side

1. L\_Introduction.jpg (10 seconds)
2. L\_Contents\_Video1.wmv (10 seconds)
3. L\_Contents\_Video2.wmv (20 seconds)
4. L\_Contents\_Video3.wmv (\*1)

### Child side

1. R\_Introduction.jpg (10 seconds)
2. R\_Contents\_Video1.wmv (10 seconds)
3. R\_Contents\_Video2.wmv (20 seconds)
4. R\_Contents\_Video3.wmv (\*1)

\*1: Played for the duration of the play time of L\_Contents\_Video3.wmv (Parent side).

### Note

- While the menu screen is not displayed, you can skip to the next playback file with ►, to the previous playback file with ◀, or play back again from the beginning of the file with ▼ (Remote control operation only).

When this operation is performed, a black screen is inserted before playback.

- [Multi display settings] supports 2×1, 1×2 and 2×2. (see page 58)

## ■ USB memory contents check

You can run a USB memory contents check in [USB media player settings] - [Scenario file check]. (see page 73)

If an error is present, the information is given with the following details.

A(B): C  
D

A: Name of the file with an error

B: Row with an error

C: Error code

D: Detail of the error

### Note

- Shows leading error codes.

Details of the detected errors are as follows.

Error code	Detail of the error
1.	No USB memory is inserted.
2.	scenario.dat/filelist.dat cannot be opened.
3.	There is an error in the contents of scenario.dat/filelist.dat.
4.	The play file format is not supported.
5.	No play file exists.
6.	The necessary group ID for Multi Media Player has not been specified.
7.	There are several identical file definitions.
8.	The scenario's play time is over the limit.
9.	The file definition listed in the scenario is not in the file list.
10.	The scenario contains 0 or over 1000 play files.
11.	There are 0 or over 1000 play files. (Single Media Player (Type 1) only)
12.	Only the group ID is listed on the file list. (Multi Media Player only)

- For error code 1 and 11, only the error code and the detail of the error are displayed as shown below.

1

No USB memory is inserted.

### Supplementary note

The USB memory contents check does not determine whether or not a play file is playable.

If a file cannot be played while Media Player is active, an error message will be displayed.

When performing the synchronized playback on the Multi Media Player, check in the menu [USB media player settings] - [Scenario file check] that the file is playable.



## Network environment (Multi Media Player only)

### ■ Example of setting up LAN connection and IP address / Subnet mask

As mentioned below, connect several units together with LAN cables and set up IP addresses / Subnet masks so that all the displays exist on the same network.

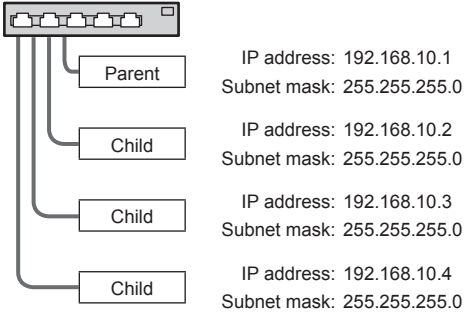

#### Note

- Set [Network control] of all displays to [On]. (see page 70)
- Depending on the network environment, synchronization may be largely lost.
- Do not connect other devices to prevent network traffic jam.
- With a router put in between, you cannot set up connection. Use them within the same subnet.
- Do not use wireless LAN for connection since playback may not be performed normally.

## Starting / ending Media Player

### ■ For Single Media Player

#### Start

1. Insert USB memory for Media Player.

#### Note

- Depending on the type of a USB memory device, it may come in contact with the periphery such as a back cover, and cannot be attached. Use a commercially sold extension cable, or use a small type of a USB memory device connectable to this unit.

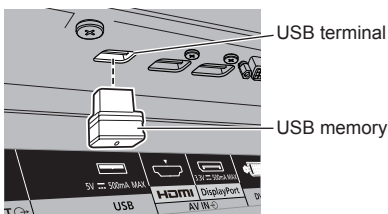

2. Run a USB memory contents check.
3. Change INPUT to [USB].

#### Ending

Change INPUT to other than [USB].

### ■ For Multi Media Player

#### Start

1. Connect several units with LAN cables.  
(See "Example of setting up LAN connection and IP address / Subnet mask" in the previous section.)
2. Insert USB memory for Media Player into each Display.
3. Executes USB memory contents check on each Display.
4. Change INPUT for Child to [USB].
5. Change INPUT for Parent to [USB].

#### Ending

Change INPUT for Parent to other than [USB].

## Resume Play function

After Media Player ends, the file to be resumed when resuming playing varies depending on the setting of [USB media player settings] - [Resume play].

#### When set to [On]:

The file played prior to the end of Media Player starts playing from the beginning.

#### When set to [Off]:

Play starts from the beginning of the first file of the scenario.

#### Note

- The resume play function is retained until the unit is turned off or the USB memory device is taken out.

# Data Cloning

Menu settings and adjusted values set on a single display can be copied to multiple displays via LAN or using a USB memory.

## ■ Data that can be copied

Settings and set values of [Picture], [Sound], [Setup], [Position] and [Options] menus

User image registered in [Setup] - [Startup image settings]

- The following data cannot be copied. Setting is required for each display.

[Date and time]

Setting for [Network settings] - [LAN setup]

Display ID in [Control settings]

Setting for [Signal] - [Multi dynamic backlight settings]

Setting for [Options] - [Long life settings]

## ■ Supported device

- Commercially available USB memory devices are supported. (Those with security functions are not supported.)
- USB memory devices other than those formatted in FAT16 or FAT32 cannot be used.
- Up to 32 GB of USB memory in size are supported.
- Only single partition configuration is supported.

### Note

- Set the input to something other than [USB], and perform the data cloning.
- [USB data cloning] can also be displayed using the main unit buttons.  
Operate in the same way as described in "Options Adjustments" - "Unit" (see page 78).
- The remote control is necessary to operate [LAN data cloning].

## Copying data to other display via LAN

- 1 Display [Setup] menu pressing <SETUP>.
- 2 Select [OSD language] with ▲▼ and press <ENTER> for over 3 seconds.

The following display appears.

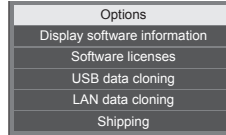

- 3 Select [LAN data cloning] with ▲▼ and press <ENTER>.
- 4 Select [Select display] with ▲▼ and press <ENTER>.

Displays on the same subnet are listed.

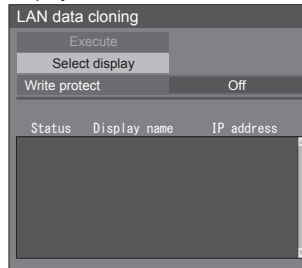

- 5 Select the display to copy the data to with ▲▼ and press <VOL +>.

Select all the displays to copy the data to.

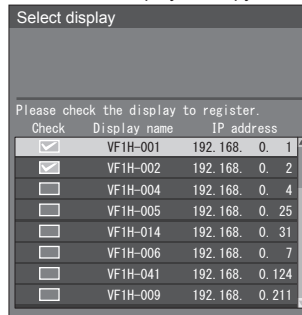

- 6 Press <ENTER>.

## 7 Select [Execute] with ▲▼ and press <ENTER>.

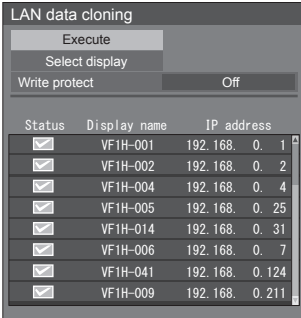

### Note

- Data cannot be copied to the display for which [Write protect] is set to [On]. Set this to [On] to prevent [LAN data cloning] from being performed mistakenly when data copy is not necessary.
- Once [LAN data cloning] is performed, [Write protect] is set to [On].

## 8 A confirmation window appears.

Select [Execute] with ◀▶ and press <ENTER>.

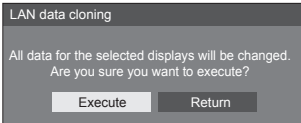

Data copy to the display starts.

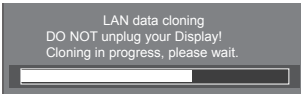

## 9 The exit screen appears.

The green mark on the list shows the data has been copied successfully. The red mark shows failure. If the red mark appears, check the LAN cable connection or power status of the display of the copy destination.

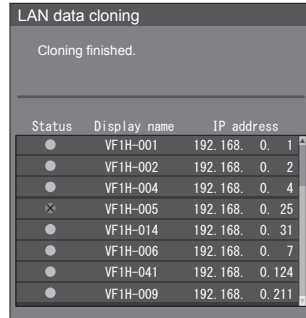

If the data copy has finished, the message appears on the display of the copy destination.

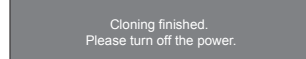

## 10 Switch the <Main power switch> (○ / | ) on the display of the copy destination to (○) to turn the power OFF.

The copied content is applied to the display.

- Alternatively, disconnect the AC cord plug from the wall outlet.

### Note

- If the data is copied with [POWER button lock] set to [On], this function operates after turning the power off, and the <Power button (Unit)> cannot be used to turn the power on. In this case, remove the power plug, wait sufficient time, and then connect the power plug again to turn the power on.
- [POWER button lock] function is only for TH-55VF1HU.

## Copying the display data to the USB memory

- 1 Insert the USB memory device to the USB terminal at the bottom of the display.

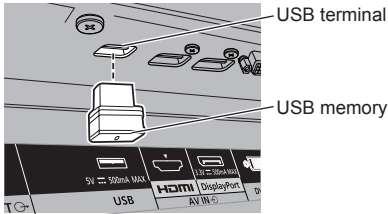

### Note

- Depending on the type of a USB memory device, it may come in contact with the periphery such as a back cover, and cannot be attached. Use a commercially sold extension cable, or use a small type of a USB memory device connectable to this unit.
- Failure to save in or read from the USB memory displays an error message.

- 2 After the [Select Copy Type] screen is displayed, go to the step 6.

When the [Select Copy Type] screen is not displayed, follow the steps 3 to 5 to display.

- 3 Display [Setup] menu pressing <SETUP>.
- 4 Select [OSD language] with ▲ ▼ and press <ENTER> for over 3 seconds.

The following display appears.

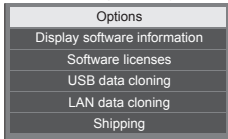

- 5 Select [USB data cloning] with ▲ ▼ and press <ENTER>.
- 6 Select [Display → USB Memory] with ▲ ▼ and press <ENTER>.



- 7 Select [YES] with ◀ ▶ and press <ENTER>.

Data copy to the USB memory starts.

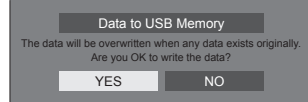

The following message is displayed after data copy has finished.



- 8 After data copy has finished, remove the USB memory device from the USB terminal.

## Copying the USB memory data to the display

**1 Insert the USB memory device, which the data has been copied, to the USB terminal of the display for data copy (same as the step 1 on page 108).**

**2 After the [Select Copy Type] screen is displayed, go to the step 6.**

When the [Select Copy Type] screen is not displayed, follow the steps 3 to 5 to display.

### Note

- If the USB memory containing the data for cloning is connected in power-on state, the [Select Copy Type] message is displayed.

**3 Display [Setup] menu pressing <SETUP>.**

**4 Select [OSD language] with ▲ ▼ and press <ENTER> for over 3 seconds.**

The following display appears.

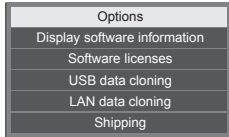

**5 Select [USB data cloning] with ▲ ▼ and press <ENTER>.**

**6 Select [USB Memory → Display] with ▲ ▼ and press <ENTER>.**

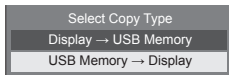

**7 Select [YES] with ◀ ▶ and press <ENTER>.**

Data copy to the display starts.

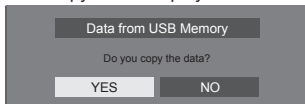

The following message is displayed after data copy has finished.

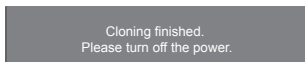

**8 After data copy has finished, remove the USB memory device from the USB terminal.**

**9 Turn the power off by switching the <Main power switch> (○ / | ) OFF (○).**

The copied content is applied to the display.

- Or, disconnect the AC cord plug from the wall outlet.
- When USB memory is not removed in the step 8, the message [Select Copy Type] is displayed when the display is turned on again.

### Note

- If the data is copied with [POWER button lock] set to [On], this function operates after turning the power off, and the <Power button (Unit)> cannot be used to turn the power on. In this case, remove the power plug, wait sufficient time, and then connect the power plug again to turn the power on.
- [POWER button lock] function is only for TH-55VF1HU.

# USB memory network settings

Using a USB memory device, the network setting can be made for multiple displays.

## About the setting

The following items in [Network settings] - [LAN setup] can be set.

[IP address], [Subnet mask], [Gateway], [Port]

### Note

- [Network settings] - [LAN setup] - [DHCP] is set to [Off].
- [Network settings] - [Network control] is set to [On].
- Make sure that [Network settings] - [USB memory network settings] is set to [Permit].

If it is set to [Prohibit], network setting cannot be made with this function. (see page 73)

## Supported device

- Commercially available USB memory devices are supported. (Those with security functions are not supported. Operation is not guaranteed.)
- USB memory devices other than those formatted in FAT16 or FAT32 cannot be used.
- Up to 32 GB of USB memory in size are supported.
- Only single partition configuration is supported.
- Use a writable USB memory device.

## Saving the LAN setting file to the USB memory device

Create the following files, and save them to the USB memory device.

File name: `th-55vf1h_network.sh`

Setting Example

```
TH-55VF1H_LAN_SETTINGS
A:192.168.0.18
S:255.255.255.0
G:192.168.0.1
P:1024
I:ON
```

## TH-55VF1H\_LAN\_SETTINGS:

Fixed characters representing the model name

Be sure to input.

**A:** Specifies the IP address.

**S:** Specifies the subnet mask

**G:** Specifies the gateway address

**P:** Specifies the port number

**I:** Setting this to [ON] can set individual IP addresses for each main unit.

One IP address is assigned to each main unit in the range that can be specified as an IP address.

### Note

- Deleting the rows S, G, P and I will not overwrite the deleted setting items. The original setting contents are retained.

- Be sure to fill in the rows of the fixed character and IP address.

- If the network setting fails with this function, an error message is displayed.

If fails, the network setting is not changed.

Be sure to confirm the file description, and insert the USB memory device again.

- This function operates only when a file with the above file name exists in the USB memory device.
- Use one-byte alphanumeric characters to describe file contents.

## Copying the USB memory data to the display

- 1 Insert the USB memory device to the USB terminal at the bottom of the display.

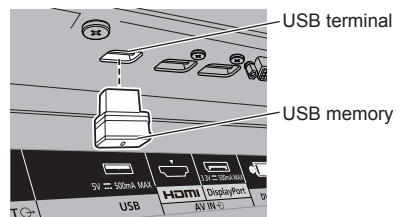

- 2 The [LAN setup] screen is displayed after data copy has finished.
- 3 Remove the USB memory device from the USB terminal.

# Controller ID function

You can set the remote control ID when you want to use this remote control on one of several different displays. In that case, you need to set the remote control's ID number to match the Display's ID number you have set in [Control settings] - [Display ID] following the steps below.



## Setting the remote control's ID number

### 1 Set [Control settings] - [Controller ID function] to [On].

(see page 55)

### 2 Set the remote control's <ID MODE> switch to <ON>.

### 3 Pointing the remote control at the Display you want to control, press <ID SET>.

ID set	
Display ID	0
Controller ID	?

### 4 Press one of <0> - <9>.

Sets the tens digit.

### 5 Press one of <0> - <9>.

Sets the units digit.

- The steps from 3 to 5 need to be done within 5 seconds.
- Adjustable ID number range is 0 - 100.

Example:

- To set the ID to "1": After step 3, press <0> and then <1>.
- To set the ID to "12": After step 3, press <1> and then <2>.
- To set the ID to "100": After step 3, press <1> <0> <0>.

## Canceling the setting of remote control's ID number (ID "0")

You can operate even if the ID does not match the ID set in [Control settings] - [Display ID].

### Press <ID SET> for more than 3 seconds.

This has the same effect as pressing <ID SET> <0> <0>.

#### Note

- The ID remote control cannot be used when [Display ID] is set to anything other than "0", and the remote control ID is not the same as the [Display ID] number. (see page 55)

# Entering characters

Some settings require to enter characters.

To enter text, select characters in the on-screen keyboard.

Example: Entering profile names ([Memory save])



The default profile name is [MEMORY1], here, we are changing it to [MY PICTURE] as an example.

## 1 Select [All delete] with ▲ ▼ ◀ ▶, and press <ENTER>.

MEMORY1

All text is deleted.

To delete individual characters, select [Delete].

## 2 Select [a / A / @] with ▲ ▼ ◀ ▶, and press <ENTER>.



Switches the keyboard to the upper case alphabet.

Each time <ENTER> is pressed, the keyboard is switched in the order of lower case, upper case and symbols.

## 3 Select [M] with ▲ ▼ ◀ ▶, and press <ENTER>.

M

Repeat this process to enter the next character.

## 4 Select Space key with ▲ ▼ ◀ ▶, and press <ENTER>.



Space key

As shown in step 3, select the characters to enter [PICTURE].

## 5 When you finished entering the profile name, select [OK] with ▲ ▼ ◀ ▶ and press <ENTER>.



- To cancel saving the profile, select [Cancel].



# Preset Signals

This unit can display the video signals shown in the table below.

## ■ Video signal

Corresponding signal	Resolution (Dot)	Scanning frequency		Dot clock frequency (MHz)	Format* <sup>3</sup>
		Horizontal (kHz)	Vertical (Hz)		
NTSC/NTSC4.43/ PAL-M/PAL60	720 × 480i	15.73	59.94	13.50	V
PAL/PAL-N/SECAM	720 × 576i	15.63	50.00	13.50	V
525i(480i)	720 × 480i	15.73	59.94	13.50	R/Y
625i(576i)	720 × 576i	15.63	50.00	13.50	R/Y
525i(480i)	720(1 440) × 480i* <sup>2</sup>	15.73	59.94	27.00	D/H/DP/DL
625i(576i)	720(1 440) × 576i* <sup>2</sup>	15.63	50.00	27.00	D/H/DP/DL
525p(480p)	720 × 480	31.47	59.94	27.00	R/Y/D/H/DP/DL
625p(576p)	720 × 576	31.25	50.00	27.00	R/Y/D/H/DP/DL
750(720)/60p	1 280 × 720	45.00	60.00	47.25	R/Y/D/H/DP/DL
750(720)/50p	1 280 × 720	37.50	50.00	74.25	R/Y/D/H/DP/DL
1125(1080)/60i* <sup>1</sup>	1 920 × 1 080i	33.75	60.00	74.25	R/Y/D/H/DP/DL
1125(1080)/50i	1 920 × 1 080i	28.13	60.00	74.25	R/Y/D/H/DP/DL
1125(1080)/24p	1 920 × 1 080	27.00	24.00	74.25	R/Y/D/H/DP/DL
1125(1080)/24PsF	1 920 × 1 080i	27.00	48.00	74.25	R/Y
1125(1080)/25p	1 920 × 1 080	28.13	25.00	74.25	R/Y/D/H/DP/DL
1125(1080)/30p	1 920 × 1 080	33.75	30.00	74.25	R/Y/D/H/DP/DL
1125(1080)/60p	1 920 × 1 080	67.50	60.00	148.50	R/Y/D/H/DP/DL
1125(1080)/50p	1 920 × 1 080	56.25	50.00	148.50	R/Y/D/H/DP/DL

## ■ PC signal

Corresponding signal	Resolution (Dot)	Scanning frequency		Dot clock frequency (MHz)	Format* <sup>3</sup>
		Horizontal (kHz)	Vertical (Hz)		
VESA400* <sup>7</sup>	640 × 400	31.47	70.09	25.18	R/Y/D/H/DP/DL
		37.86	85.08	31.50	R/Y/D/H/DP/DL
VGA* <sup>7</sup>	640 × 480	31.47	59.94	25.18	R/Y/D/H/DP/DL
		35.00	66.67	30.24	R/Y/D/H/DP/DL
		37.86	72.81	31.50	R/Y/D/H/DP/DL
		37.50	75.00	31.50	R/Y/D/H/DP/DL
		43.27	85.01	36.00	R/Y/D/H/DP/DL
SVGA* <sup>7</sup>	800 × 600	35.16	56.25	36.00	R/Y/D/H/DP/DL
		37.88	60.32	40.00	R/Y/D/H/DP/DL
		48.08	72.19	50.00	R/Y/D/H/DP/DL
		46.88	75.00	49.50	R/Y/D/H/DP/DL
		53.67	85.06	56.25	R/Y/D/H/DP/DL
MAC16* <sup>7</sup>	832 × 624	49.72	74.55	57.28	R/Y/D/H/DP/DL
852 × 480* <sup>7</sup>	852 × 480	31.47	59.94	34.24	D/H/DP/DL
		39.55	50.00	51.89	D/H/DP/DL
XGA* <sup>7</sup>	1 024 × 768	48.36	60.00	65.00	R/Y/D/H/DP/DL
		56.48	70.07	75.00	R/Y/D/H/DP/DL
		60.02	75.03	78.75	R/Y/D/H/DP/DL
		65.55	81.63	86.00	R/Y/D/H/DP/DL
		68.68	85.00	94.50	R/Y/D/H/DP/DL
		37.64	59.94	53.00	D/H/DP/DL
WSVGA* <sup>7</sup>	1 066 × 600	53.70	60.00	81.62	D/H/DP/DL
		63.99	70.02	94.20	R/Y/D/H/DP/DL
		67.50	75.00	108.00	R/Y/D/H/DP/DL
		77.09	85.00	119.65	R/Y/D/H/DP/DL
MAC21* <sup>7</sup>	1 152 × 870	68.68	75.06	100.00	R/Y/D/H/DP/DL
1280 × 720* <sup>7</sup>	1 280 × 720	44.76	60.00	74.48	R/Y/D/H/DP/DL
		39.55	49.94	65.18	R/Y/D/H/DP/DL
1280 × 768* <sup>7</sup>	1 280 × 768	47.70	60.00	80.14	R/Y/D/H/DP/DL
		47.78	59.87	79.50	R/Y/D/H/DP/DL

Corresponding signal	Resolution (Dot)	Scanning frequency		Dot clock frequency (MHz)	Format*3
		Horizontal (kHz)	Vertical (Hz)		
1280 × 800*7	1 280 × 800	41.20	50.00	68.56	R/Y/D/H/DP/DL
		49.31	59.91	71.00	R/Y/D/H/DP/DL
		49.70	59.81	83.50	R/Y/D/H/DP/DL
MSXGA*7	1 280 × 960	60.00	60.00	108.00	R/Y/D/H/DP/DL
		85.94	85.00	148.50	R/Y
SXGA*7	1 280 × 1 024	63.98	60.02	108.00	R/Y/D/H/DP/DL
		79.98	75.02	135.00	R/Y/D/H/DP/DL
		91.15	85.02	157.50	R/Y/D/H/DP/DL
1360 × 768*7	1 360 × 768	47.71	60.02	85.50	D/H/DP/DL
		47.70	60.00	84.72	D/H/DP/DL
		47.72	59.80	84.75	D/H/DP/DL
1366 × 768*7	1 366 × 768	39.55	50.00	69.92	D/H/DP/DL
		48.39	60.03	86.71	R/Y/D/H/DP/DL
		48.00	60.00	72.00	R/Y/D/H/DP/DL
		39.56	49.89	69.00	R/Y/D/H/DP/DL
		47.71	59.79	85.50	R/Y/D/H/DP/DL
		65.22	60.00	122.61	D/H/DP/DL
SXGA+*7	1 400 × 1 050	82.20	75.00	155.85	R/Y/D/H/DP/DL
		55.47	59.90	88.75	R/Y/D/H/DP/DL
WXGA+*7	1 440 × 900	55.92	60.00	106.47	R/Y/D/H/DP/DL
		46.30	50.00	97.05	D/H/DP/DL
1600 × 900*7	1 600 × 900	60.00	60.00	108.00	D/H/DP/DL
		55.99	59.95	118.25	D/H/DP/DL
		55.92	60.00	119.00	D/H/DP/DL
		65.29	59.95	146.25	R/Y/D/H/DP/DL
WSXGA+*7	1 680 × 1 050	65.29	59.95	146.25	R/Y/D/H/DP/DL
UXGA*7	1 600 × 1 200 *4	75.00	60.00	162.00	R/Y/D/H/DP/DL
1920 × 1080*7	1 920 × 1 080 *5	66.59	59.93	138.50	R/Y/D/H/DP/DL
	1 920 × 1 080	67.50	60.00	148.50	R/Y/D/H/DP/DL
WUXGA*7	1 920 × 1 200 *4*6	74.04	59.95	154.00	R/Y/D/H/DP/DL

\*1: When 1 125(1 035)/60i signal is input, it is displayed as 1 125(1 080)/60i signal.

\*2: Pixel-Repetition signal (dot clock frequency 27.0 MHz) only

\*3: Signals to represent formats are as follows.

- V : Composite Video (VIDEO IN)
  - R : D-sub RGB (RGB IN, PC IN)
  - Y : YCbCr/YPbPr (COMPONENT IN, PC IN)
  - D : DVI-D (DVI-D IN 1, DVI-D IN 2)
  - H : HDMI (HDMI)
  - DP : DisplayPort (DisplayPort)
  - DL : DIGITAL LINK (DIGITAL LINK)
- The analogue input supports onG and onY.

\*4: Displayed with image elements thinned out in the image processing circuit.

\*5: Based on VESA CVT-RB (Reduced Blanking) standard

\*6: Not supported when [DIGITAL LINK mode] is set to [Long reach].

\*7: The picture may not be displayed correctly with the PC signal from COMPONENT IN/RGB IN inputs.

**Note**

- An auto detected signal format may be differently displayed from the actual input signal.
- [ i ] shown after the number of dots of resolution means the interlace signal.
- When 1 125(1 080)/30PsF signal and 1 125(1 080)/25PsF signal are input, they are processed as 1 125(1 080)/60i signal and 1 125(1 080)/50i signal, and then displayed.

# Shipping condition

You can reset the settings / the adjusted values of the following menus to the factory settings:

[Picture], [Sound], [Setup], [Position], [Options]

## Note

- The setting for [Options] - [Long life settings] is not reset to the factory setting with [Shipping].

## ■ Remote control

- 1 Press **<SETUP>** to display the [Setup] menu.
- 2 Select [OSD language] with **▲▼** and press **<ENTER>** for more than 3 seconds.

The following screen will be displayed.

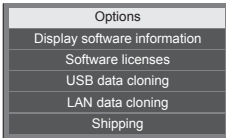

- 3 Select [Shipping] with **▲▼** and press **<ENTER>**.

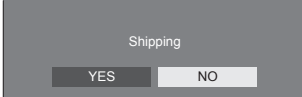

- 4 Select [YES] with **◀▶** and press **<ENTER>**.

The message [Shipping ( Wait a moment )] will be displayed.

- 5 After the message [Please turn off the power] is displayed, turn the power off by switching the **<Main power switch>** ( **○ / |** ) **OFF** ( **○** ).

- Or, disconnect the AC cord plug from the wall outlet.











## ■ Unit

- 1 Press **<MENU (Unit)>** for several times and display the [Setup] menu.
- 2 Select [Menu display duration] with **▲▼**, and then press and hold **<ENTER (Unit)>** for more than 5 seconds.
- 3 Select [YES] with **<- (Unit)>** and press **<ENTER (Unit)>**.  
The message [Shipping ( Wait a moment )] will be displayed.
- 4 After the message [Please turn off the power] is displayed, turn the power off by switching the **<Main power switch>** ( **○ / |** ) **OFF** ( **○** ).

- Or, disconnect the AC cord plug from the wall outlet.

# Troubleshooting

Before you call for service, determine the symptoms and make a few simple checks as shown below.

Symptoms		Check
Picture	Sound	
 <p>Interference</p>	 <p>Noisy Sound</p>	<p>Electrical Appliances Cars / Motorcycles Fluorescent light</p>
 <p>Normal Picture</p>	 <p>No Sound</p>	<p>Volume (Check whether the mute function has been activated on the remote control.)</p>
 <p>No Picture</p>	 <p>No Sound</p>	<p>Not plugged into AC outlet Not switched on Picture and Brightness/Volume setting (Check by pressing the &lt;Main power switch&gt; or &lt;POWER ON&gt; button on the remote control.)</p>
 <p>No Picture</p>	 <p>Normal Sound</p>	<p>If a signal with a non-applicable colour system format, or frequency is input, only the input terminal indication is displayed.</p>
 <p>No Colour</p>	 <p>Normal Sound</p>	<p>Colour controls set at minimum level (see page 45)</p>
<p>Power cannot be turned on.</p>		<p>Check that the power plug or the connector are not disconnected from the socket or the display. (see page 17) Check that the &lt;Main power switch&gt; at the back of the display is switched to ON (   ). (see page 33)</p>
<p>Power automatically turns off unexpectedly.</p>		<p>Check the settings of [No signal power off], [HDMI power management], [DIGITAL LINK power management], [DVI-D1 power management], [DVI-D2 power management], [PC power management] and [No activity power off]. Any of them may be set to [On (Enable)]. (see page 67 - 68)</p>
<p>Power indicator is blinking in red.</p>		<p>There is possibility of malfunction. Please contact an Authorized Service Centre.</p>
<p>No remote control operations can be performed.</p>		<p>Check whether the batteries have discharged completely and, if they have not, whether they were inserted properly. Check whether the remote control sensor is exposed to an outdoor light or a strong fluorescent light. Check whether any obstacle is present between the remote control sensor and the remote control. Check whether the remote control designed specifically for use with the unit is being used. (The unit cannot be operated by any other remote control.) Check whether the option other than [Off] is selected in [Controller user level] in the [Options] menu. (see page 81) Check whether [Control settings] - [Controller ID function] menu is set to [On]. (see page 55) Check whether &lt;ID MODE&gt; switch is set to &lt;ON&gt;. (see page 111)</p>

Symptoms	Check
[Controller ID function] cannot be used.	<p>Check whether [Control settings] - [Controller ID function] is set to [On] (see page 55), or &lt;ID MODE&gt; switch is set to &lt;ON&gt;.</p> <p>(When [Controller ID function] is set to [On], you need to set &lt;ID MODE&gt; switch to &lt;ON&gt; and set the ID number.)</p>
The top or bottom of the picture on the screen is cut off.	<p>The image position has been adjusted in the [Position] menu.</p> <p>Adjust the position of the picture on the screen. (see page 42, 43)</p>
There are areas at the top and bottom of the screen where picture is not displayed.	<p>When using a video software program (such as a cinema size program) with a screen wider than one in the 16:9 mode, blank areas separate from the images are formed at the top and bottom of the screen.</p>
Parts of the unit become hot.	<p>Even when the temperature of parts of the front, top and rear panels has risen, these temperature rises will not pose any problems in terms of performance or quality.</p>
There is no picture displayed or sound output sometimes.	<p>When HDMI or DVI signals are input to the Display using a selector or distributor, sound or images may not be output in the normal fashion depending on the selector or distributor used.</p> <p>The symptoms may be improved by turning the power off and on again, or by replacing the selector or distributor.</p>
The RS-232C is uncontrollable.	<p>Check that the connection has been made properly. (see page 26)</p> <p>To control RS-232C with the Display's SERIAL IN terminal: Check that [Control settings] - [Serial control] is set to [SERIAL IN].</p> <p>To control RS-232C with the twisted pair cable transmitter: Check that [Control settings] - [Serial control] is set to [DIGITAL LINK], [Network settings] - [Network control] is set to [On] and [DIGITAL LINK mode] is set to [Auto], [DIGITAL LINK] or [Long reach]. (see page 55, 72)</p>
The LAN is uncontrollable.	<p>Check that the connection has been made properly. (see page 84)</p> <p>To control with WEB browser control or command control, check that [Network settings] - [Network control] is set to [On]. (see page 70)</p> <p>Check that [LAN setup] is set properly. (see page 71)</p> <p>When connecting to a device of AMX, Extron or Crestron Electronics, Inc., set [AMX D. D.], [Extron XTP] or [Crestron Connected™] according to the device to use. (see page 73)</p> <p>See the [DIGITAL LINK status] - [Signal quality] information to check the LAN cable status such as whether the LAN cable is disconnected or the cable is not shielded. (see page 72)</p>

Symptoms	Check
There is no picture displayed or sound output from the [DIGITAL LINK] terminal.	Check whether the connection has been made properly between the video (output) equipment and twisted pair cable transmitter and between the twisted pair cable transmitter and this product. (see page 85) Check that [Network settings] - [DIGITAL LINK mode] is not set to [Ethernet]. (see page 72)

### LCD Display panel

Symptoms	Check
The screen darkens slightly when bright pictures with minimal movements are shown.	The screen will darken slightly when photos, still images of a computer or other pictures with minimal movements are shown for an extended period. This is done to reduce image retention on the screen and the shortening of the screen's service life: It is normal and not indicative of malfunctioning.
It takes a while for the picture to appear.	The unit digitally processes the various signals in order to reproduce esthetically pleasing images. As such, it sometimes takes a few moments for the picture to appear when the power has been turned on, when the input has been switched.
The edges of the images flicker.	Due to the characteristics of the system used to drive the panel, the edges may appear to flicker in the fast-moving parts of the images: This is normal and not indicative of malfunctioning.
There may be red spots, blue spots, green spots and black spots on the screen.	This is a characteristic of liquid crystal panels and is not a problem. The liquid crystal panel is built with very high precision technology giving you fine picture details. Occasionally, a few non-active pixels may appear on the screen as fixed points of red, blue, green, or black. Please note this does not affect the performance of your LCD.
 <p>Image retention appears</p>	Image retention may occur. If you display a still picture for an extended period, the image might remain on the screen. However, it will disappear when a general moving picture is displayed for a while. This is not considered as malfunction.

This LCD Display uses special image processing. Hence a slight time lag may occur between image and audio, depending on the type of input signal. However, this is not a malfunction.

# Specifications

## Model No.

TH-55VF1HU  
TH-55VF1HW

## Power Consumption

300 W

### Power off with the <Main power switch>

0 W

### Stand-by condition

0.5 W

## LCD Display panel

55-inch IPS panel (Direct LED backlight), 16:9 aspect ratio

## Screen size

1 209 mm (W) × 680 mm (H) × 1 387 mm (diagonal) /  
47.6" (W) × 26.7" (H) × 54.6" (diagonal)

### (No. of pixels)

2 073 600

(1 920 (Horizontal) × 1 080 (Vertical))

## Dimensions (W × H × D)

1 212 mm × 683 mm × 99 mm /  
47.7" × 26.9" × 3.9" (without handles)

## Mass

approx. 25.0 kg / 56.0 lbs net

## Power source

TH-55VF1HU:

110 – 127 V ~ (110 – 127 V alternating current),  
50/60Hz

TH-55VF1HW:

220 – 240 V ~ (220 – 240 V alternating current),  
50/60Hz

## Operating condition

### Temperature

0 °C to 40 °C (32 °F to 104 °F)\*1

### Humidity

10 % to 90 % (no condensation)

## Storing condition

### Temperature

-20 °C to 60 °C (-4 °F to 140 °F)

### Humidity

10 % to 90 % (no condensation)

## Connection terminals

### HDMI

TYPE A Connector\*2 × 1

Audio signal:

Linear PCM (sampling frequencies - 48 kHz,  
44.1 kHz, 32 kHz)

### DisplayPort

DisplayPort Terminal × 1

Ver 1.1 Dual Mode only

### DVI-D IN 1

DVI-D 24 Pin × 1:

Compliance with DVI Revision 1.0

Content Protection:

Compatible with HDCP 1.1

### DVI-D IN 2

DVI-D 24 Pin × 1:

Compliance with DVI Revision 1.0

Content Protection:

Compatible with HDCP 1.1

### COMPONENT/RGB IN

Y/G

BNC terminal × 1

1.0 Vp-p (75 Ω) (with sync)

Pb/Cb/B

BNC terminal × 1

0.7 Vp-p (75 Ω) (without sync)

Pr/Cr/R

BNC terminal × 1

0.7 Vp-p (75 Ω) (without sync)

### VIDEO IN

VIDEO

BNC terminal × 1

1.0 V [p-p] (75 Ω)

Also used as Y/G terminal

## PC IN

Mini D-sub 15 Pin × 1:

Compatible with DDC2B

Y/G:

1.0 Vp-p (75 Ω) (with sync)

0.7 Vp-p (75 Ω) (without sync)

Pb/Cb/B:

0.7 Vp-p (75 Ω) (without sync)

Pr/Cr/R:

0.7 Vp-p (75 Ω) (without sync)

HD/VD:

1.0 – 5.0 Vp-p (high impedance)

## AUDIO1 IN

Stereo mini jack (M3) × 1, 0.5 Vrms

Shared with DVI-D IN 1 / DVI-D IN 2 and PC IN

## AUDIO2 IN

Pin jack × 2 (L/R), 0.5 Vrms

Shared with COMPONENT/RGB IN and VIDEO IN

## AUDIO OUT

Pin jack × 2 (L/R), 0.5 Vrms

Output: Variable (-∞ to 0 dB)

(1 kHz 0 dB input, 10 kΩ load)

## SERIAL IN

External Control Terminal

D-sub 9 Pin × 1:

RS-232C compatible

## SERIAL OUT

External Control Terminal

D-sub 9 Pin × 1:

RS-232C compatible

## DIGITAL LINK / LAN IN

## DIGITAL LINK / LAN OUT

RJ45 × 2:

For RJ45 network connections, compatible with PLink

Communication method:

RJ45 100BASE-TX

## IR IN

Stereo mini jack (M3) × 1

## IR OUT

Stereo mini jack (M3) × 1

## USB

TYPE A USB connector × 1

5V DC / 500mA (USB 3.0 is not supported.)

## EXT SP

8 Ω, 20 W [10 W + 10 W] (10 % THD)

## Sound

### Audio Output

20 W [10 W + 10 W] (10 % THD)

## Remote Control Transmitter

### Power source

DC 3 V (battery (AAA/R03/UM4 type) × 2)

### Mass

approx. 102 g (including batteries)

### Dimensions (W × H × D)

48 mm × 145 mm × 27 mm /

1.89" × 5.71" × 1.06"

\*1: Environmental temperature to use this unit at high altitudes (1 400 m (4 593 ft) and higher and below 2 800 m (9 186 ft) above sea level): 0 °C to 35 °C (32 °F to 95 °F)

\*2: VIERA LINK is not supported.

### Note

- Design and specifications are subject to change without notice. Mass and dimensions shown are approximate.



# Software License

---

This product incorporates the following software:

- (1) the software developed independently by or for Panasonic Corporation,
- (2) the software owned by third party and licensed to Panasonic Corporation,
- (3) the software licensed under the GNU General Public License, Version 2.0 (GPL V2.0),
- (4) the software licensed under the GNU LESSER General Public License, Version 2.1 (LGPL V2.1), and/or
- (5) open source software other than the software licensed under the GPL V2.0 and/or LGPL V2.1.

The software categorized as (3) - (5) are distributed in the hope that it will be useful, but WITHOUT ANY WARRANTY, without even the implied warranty of MERCHANTABILITY or FITNESS FOR A PARTICULAR PURPOSE. For details, see the license conditions displayed by selecting [Software licenses], following the specified operation from the initial setting menu of this product.

At least three (3) years from delivery of this product, Panasonic will give to any third party who contacts us at the contact information provided below, for a charge no more than our cost of physically performing source code distribution, a complete machine-readable copy of the corresponding source code covered under GPL V2.0, LGPL V2.1 or the other licenses with the obligation to do so, as well as the respective copyright notice thereof.

Contact Information:

oss-cd-request@gg.jp.panasonic.com

## Notice about AVC/VC-1/MPEG-4

This product is licensed under the AVC Patent Portfolio License, VC-1 Patent Portfolio License and MPEG-4 Visual Patent Portfolio License for the personal use of a consumer or other uses in which it does not receive remuneration to (i) encode video in compliance with the AVC Standard, VC-1 Standard and MPEG-4 Visual Standard ("AVC/VC-1/MPEG-4 Video") and/or (ii) decode AVC/VC-1/MPEG-4 Video that was encoded by a consumer engaged in a personal activity and/or was obtained from a video provider licensed to provide AVC/VC-1/MPEG-4 Video. No license is granted or shall be implied for any other use. Additional information may be obtained from MPEG LA, LLC. See <http://www.mpegla.com>.

## Disposal of Old Equipment and Batteries

### Only for European Union and countries with recycling systems



These symbols on the products, packaging, and/or accompanying documents mean that used electrical and electronic products and batteries must not be mixed with general household waste. For proper treatment, recovery and recycling of old products and used batteries, please take them to applicable collection points in accordance with your national legislation.

By disposing of them correctly, you will help to save valuable resources and prevent any potential negative effects on human health and the environment.

For more information about collection and recycling, please contact your local municipality. Penalties may be applicable for incorrect disposal of this waste, in accordance with national legislation.



#### Note for the battery symbol (bottom symbol)

This symbol might be used in combination with a chemical symbol. In this case it complies with the requirement set by the Directive for the chemical involved.

#### Information on Disposal in other Countries outside the European Union

These symbols are only valid in the European Union.

If you wish to discard these items, please contact your local authorities or dealer and ask for the correct method of disposal.

#### Notice (U.S.A. only)

Disposal may be regulated in your community due to environmental considerations. For disposal or recycling information, please visit Panasonic website:

<http://www.panasonic.com/environmental>

or call 1-888-769-0149.

#### Customer's Record

The model number and serial number of this product may be found on its rear panel. You should note this serial number in the space provided below and retain this book, plus your purchase receipt, as a permanent record of your purchase to aid in identification in the event of theft or loss, and for Warranty Service purposes.

**Model Number**

**Serial Number**

#### For TH-55VF1HU

### Panasonic System Communications Company of North America

Unit of Panasonic Corporation of North America

#### Executive Office :

Two Riverfront Plaza, Newark, New Jersey 07102-5490

#### Panasonic Canada Inc.

5770 Ambler Drive

Mississauga, Ontario

L4W 2T3

#### For TH-55VF1HW

Panasonic Testing Centre

Panasonic Service Europe, a division of Panasonic Marketing Europe GmbH

Winsbergring 15, 22525 Hamburg, F.R. Germany

Panasonic Corporation

English

Web Site: <https://panasonic.net/cns/prodisplays/>

TP1016TS1107 -PB