



Product specification (design and specification subject to change without notice)

■ DISPLAY PANEL

Screen Size (Diagonal)	65-inch (1639 mm)
Panel type	IPS / Edge-LED
Aspect ratio	16:9
Effective Display Area (W x H)	1428 x 803 mm
Number of pixels (H x V)	1920 x 1080 pixels
Brightness	450 cd/m ² (typ.)
Contrast Ratio	1300:1 (typ.)
Dynamic Contrast	50000:1 (typ.)
Max. Display Colors	approx. 1.07 Billion
Response Time	10 ms (typ.) (G to G)
Viewing Angle (Horizontal / Vertical)	178° / 178° (CR ≥ 10)
Panel Life Time ^{*1}	approx. 50000 hours (typ)
Panel Surface Treatment	Anti glare type (Haze 1%)

*1 When the panel lifetime is at 50% of the brightness under the condition of 25 degrees Celsius (+/- 2 degrees Celsius).

■ CONNECTION TERMINAL

HDMI IN	HDMI Type A Connector x 2	Linear PCM (Sampling frequency : 48 kHz/44.1 kHz/32 kHz)
VIDEO/ AUDIO IN (AV IN)	4 Port mini Jack (M3) x 1 / x 1 (AUDIO IN Shared with DVI-D IN, PC IN, VIDEO IN)	VIDEO : 1.0 V [p-p] (75 Ω) AUDIO: 0.5 V [rms]
DVI-D IN	DVI-D 24-pin x 1	Compliance with DVI Revision 1.0 Compatible with HDCP 1.1
DVI-D OUT	DVI-D 24-pin x 1	Compliance with DVI Revision 1.0 Compatible with HDCP 1.1
PC IN	Mini D-Sub 15-pin (DDC2B) x 1	Y/G : with sync 1.0 V [p-p] (75 Ω) : without sync 0.7 V [p-p] (75 Ω) P _B /C _B /B : 0.7 V [p-p] (75 Ω) P _R /C _R /R : 0.7 V [p-p] (75 Ω) HD/VD : HD/VD TTL (high impedance)
SERIAL IN / OUT	D-sub 9-pin x 1 / x 1, RS-232C Compatible	
LAN / DIGITAL LINK IN	RJ45 x 1 100BASE-TX, compatible with PLink (Shared with LAN, Long reach mode)	
IR TRANSMITTER IN / OUT	Stereo Mini Jack (M3) x 1 / x 1	
AUDIO OUT	Stereo Mini Jack (M3) x 1	0.5 V [rms]
USB	Variable (-∞ - 0 dB) (1 kHz 0 dB Input, 10 k Ω Load)	
USB	USB 2.0 Type A connector x 1 DC 5 V/1A (USB 3.0 is not supported.)	

■ AUDIO

Built in Speaker	20 W [10 W +10 W]
------------------	-------------------

■ ELECTRICAL

Power Requirements	AC 220 - 240 V 50/60 Hz
Power Consumption	155 W
On Mode Average Power Consumption*	124 W
Power Off Condition	approx. 0.3 W
Stand-by Condition	approx. 0.5 W
Apparent power	159 VA

*Based on IEC 62087 Ed.2 measurement method

■ MECHANICAL

Dimensions (W x H x D)	1452 x 834 x 64 mm
Weight	approx. 29.8 kg
Bezel Color	Black
Bezel Width	T/R/L 9.5 mm, B 15.7 mm
Carton Dimensions (W x H x D)	1648 x 1076 x 280 mm
Gross Weight	approx. 41.0 kg
Cabinet Material	Front: Metal / Back: Plastic
Pitch for Wall-Hanging	VESA Compliant 400 x 400 mm (Installed by: M6 screws / Screw hole depth 10 mm)

■ INSTALLATION

Orientation	Landscape / Portrait (Rotation: Up to 45 degrees for each right and left with the display installed landscape)
Tilting Angle	Landscape : 0 - 45 degrees forward / backward Portrait : 0 - 45 degrees forward / backward

*Please contact your sales representative with regard to the tilt angle before installation.

*When you install the product upright, be sure to make the power lamp of the main body come to the upper side.

■ ENVIRONMENTAL

Operating Environment	Temperature: 0°C to 40°C ^{*1} : 0°C to 35°C ^{*2}
	Humidity : 20% to 80% (No condensation)
	Altitude : 0 to 2800 m
Storage Environment	Temperature: -20°C to 60°C
	Humidity : 20% to 80% (No condensation)

*1 : for up to 1400 m altitude *2 : for between 1400 m and 2800 m altitude

Depending on the temperature or humidity conditions, uneven brightness may be observed. This is not a malfunction.

• This unevenness will disappear while applying current continuously. If not, consult the distributor.

MAIN FEATURE

USB Media Player	YES
Failback / Failover	YES
Data Cloning	YES
Digital ZOOM	YES
Multi display settings	YES
Power on screen delay	YES
Auto setting	YES
Screensaver	YES
HDMI power management	YES
DIGITAL LINK power management	YES
PC power management	YES
DVI-D power management	YES
Power save	YES
Button lock	YES
Controller user level	YES
Input search	YES
6-segment colour management	YES
Dynamic contrast	YES
Colour enhancement	YES
Refine enhancer	YES
Gradation smoother	YES
Set up timer	YES
AMX D.D.	YES
Crestron Connected™	YES
Extron XTP	YES
WEB Browser control	YES
PJLink™	YES
Image compatible	YES
Input Detection	YES
HDMI CEC compatible	YES
Viewer	YES
Early Warning Software compatible	YES
Multi Monitoring & Control Software compatible	YES
Video Wall Manager compatible	YES
CMS Content management Software compatible	YES

Operating Time*	24h/day
-----------------	---------

* The brightness of the display panel is equivalent to about 75% its full capacity, when the Light ID is transmitted. The displayed image may flicker, but this is due to a change in the brightness during Light ID transmission and not due to trouble.

* In case of running for a long time, the moving image is recommended to be displayed. If you display a still picture for an extended period, the image retention might remain on the screen. However, image retention can gradually disappear by displaying a moving images.

* Specifications and appearance are subject to change without notice.

STANDARD (CERTIFICATIONS)

SAFETY REGULATIONS	IEC60950-1 AS/NZS Deviation
RADIATION REGULATIONS	AS/NZS CISPR32:2013 RCM Mark

REMOTE CONTROL TRANSMITTER

Power Requirements	DC 3 V (2 x AAA Size batteries)
Operating distance	approx. 7 m*
Weight	approx. 63 g including batteries
Dimensions (W x H x D)	48 x 134 x 20 mm

*When operated directly in front of receptor.

INCLUDED ACCESSORIES

- AC cord (2.0 m) - Remote Control - Batteries (AAA size) x 2
- Clamper x 3 - User Manual

OPTIONAL ACCESSORIES

Pedestal Stand	TY-ST55PE9
----------------	------------

DIMENSIONS

Cautions: This drawing is not a scale
Units : mm

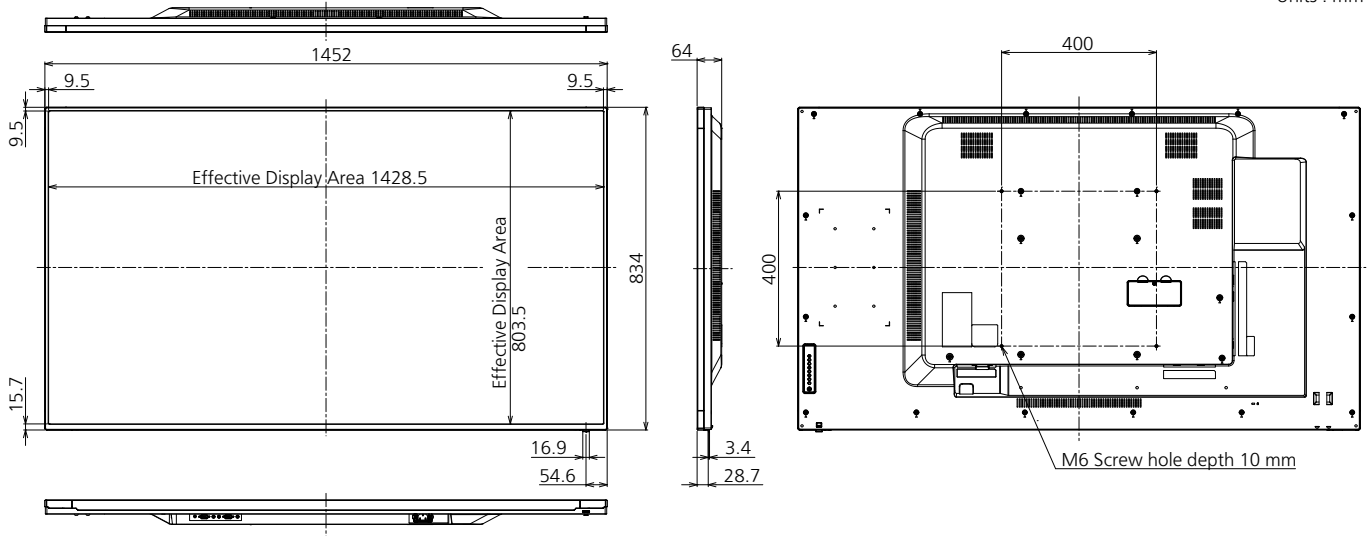

CONNECTION TERMINAL

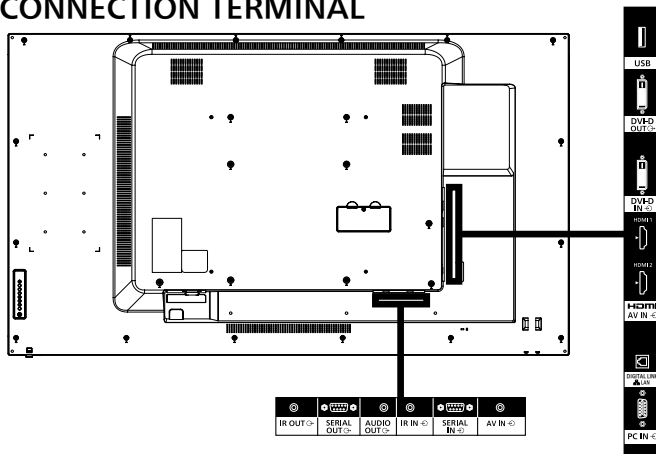

* Specifications and appearance are subject to change without notice.

List of correspondence signals

The picture signal which can indicate this machine is as it is the following table.

V : VIDEO
R : D-sub RGB
Y : YCbCr/YPbPr

D : DVI-D
H : HDMI
DL : Digital Link

Correspondence signal	Resolution (dot)	Scan rate		Dot clock rate (MHz)	Format
		Horizontal (kHz)	Vertical (Hz)		
NTSC/NTSC4.43/ PAL-M/PAL60	720 x 480i	15.73	59.94	-	V
PAL/PAL-N/SECAM	720 x 576i	15.63	50.00	-	V
480/60i	720 x 480	15.73	59.94	13.50	R/Y
576/50i	720 x 576i	15.63	50.00	13.50	R/Y
480/60i	720 (1440) x 480i ^{*2}	15.73	59.94	27.00	D/H/DL
576/50i	720 (1440) x 576i ^{*2}	15.63	50.00	27.00	D/H/DL
480/60p	720 x 483	31.47	59.94	27.00	R/Y/D/H/DL
576/50p	720 x 576	31.25	50.00	27.00	R/Y/D/H/DL
720/60p	1280 x 720	45.00	60.00	74.25	R/Y/D/H/DL
720/50p	1280 x 720	37.50	50.00	74.25	R/Y/D/H/DL
1080/60i ^{*1}	1920 x 1080i	33.75	60.00	74.25	R/Y/D/H/DL
1080/50i	1920 x 1080i	28.13	50.00	74.25	R/Y/D/H/DL
1080/24p	1920 x 1080	27.00	24.00	74.25	R/Y/D/H/DL
1080/24PsF	1920 x 1080i	27.00	48.00	74.25	R/Y
1080/25p	1920 x 1080	28.13	25.00	74.25	R/Y/D/H/DL
1080/30p	1920 x 1080	33.75	30.00	74.25	R/Y/D/H/DL
1080/60p	1920 x 1080	67.50	60.00	148.50	R/Y/D/H/DL
1080/50p	1920 x 1080	56.25	50.00	148.50	R/Y/D/H/DL
640 x 400/70	640 x 400	31.47	70.09	25.18	R/Y/D/H/DL
640 x 400/85	640 x 400	37.86	85.08	31.50	R/Y/D/H/DL
640 x 480/60	640 x 480	31.47	59.94	25.18	R/Y/D/H/DL
640 x 480/67	640 x 480	35.00	66.67	30.24	R/Y/D/H/DL
640 x 480/73	640 x 480	37.86	72.81	31.50	R/Y/D/H/DL
640 x 480/75	640 x 480	37.50	75.00	31.50	R/Y/D/H/DL
640 x 480/85	640 x 480	43.27	85.01	36.00	R/Y/D/H/DL
800 x 600/56	800 x 600	35.16	56.25	36.00	R/Y/D/H/DL
800 x 600/60	800 x 600	37.88	60.32	40.00	R/Y/D/H/DL
800 x 600/72	800 x 600	48.08	72.19	50.00	R/Y/D/H/DL
800 x 600/75	800 x 600	46.88	75.00	49.50	R/Y/D/H/DL
800 x 600/85	800 x 600	53.67	85.06	56.25	R/Y/D/H/DL
832 x 624/75	832 x 624	49.72	74.55	57.28	R/Y/D/H/DL
852 x 480/60	852 x 480	31.47	59.94	34.24	D/H/DL
1024 x 768/50	1024 x 768	39.55	50.00	51.89	D/H/DL
1024 x 768/60	1024 x 768	48.36	60.00	65.00	R/Y/D/H/DL
1024 x 768/70	1024 x 768	56.48	70.07	75.00	R/Y/D/H/DL
1024 x 768/75	1024 x 768	60.02	75.03	78.75	R/Y/D/H/DL
1024 x 768/82	1024 x 768	65.55	81.63	86.00	R/Y/D/H/DL
1024 x 768/85	1024 x 768	68.68	85.00	94.50	R/Y/D/H/DL
1066 x 600/60	1066 x 600	37.64	59.94	53.00	D/H/DL
1152 x 864/60	1152 x 864	53.70	60.00	81.62	D/H/DL
1152 x 864/70	1152 x 864	63.99	70.02	94.20	R/Y/D/H/DL
1152 x 864/75	1152 x 864	67.50	75.00	108.00	R/Y/D/H/DL
1152 x 864/85	1152 x 864	77.09	85.00	119.65	R/Y/D/H/DL
1152 x 870/75	1152 x 870	68.68	75.06	100.00	R/Y/D/H/DL
1280 x 720/60	1280 x 720	44.76	60.00	74.48	R/Y/D/H/DL
1280 x 768/50	1280 x 768	39.55	49.94	65.18	R/Y/D/H/DL
1280 x 768/60	1280 x 768	47.70	60.00	80.14	R/Y/D/H/DL
	1280 x 768	47.78	59.87	79.50	R/Y/D/H/DL
1280 x 800/50	1280 x 800	41.20	50.00	68.56	R/Y/D/H/DL
1280 x 800/60	1280 x 800	49.31	59.91	71.00	R/Y/D/H/DL
	1280 x 800	49.70	59.81	83.50	R/Y/D/H/DL
1280 x 960/60	1280 x 960	60.00	60.00	108.00	R/Y/D/H/DL
1280 x 960/85	1280 x 960	85.94	85.00	148.50	R/Y
1280 x 1024/60	1280 x 1024	63.98	60.02	108.00	R/Y/D/H/DL
1280 x 1024/75	1280 x 1024	79.98	75.02	135.00	R/Y/D/H/DL
1280 x 1024/85	1280 x 1024	91.15	85.02	157.50	R/Y/D/H/DL
1360 x 768/60	1360 x 768	47.71	60.02	85.50	D/H/DL
	1360 x 768	47.70	60.00	84.72	D/H/DL
	1360 x 768	47.72	59.80	84.75	D/H/DL
1366 x 768/50	1366 x 768	39.55	50.00	69.92	D/H/DL
1366 x 768/60	1366 x 768	48.39	60.03	86.71	R/Y/D/H/DL
	1366 x 768	48.00	60.00	72.00	R/Y/D/H/DL
1366 x 768/50	1366 x 768	39.56	49.89	69.00	R/Y/D/H/DL
1366 x 768/60	1366 x 768	47.71	59.79	85.50	R/Y/D/H/DL
1400 x 1050/60	1400 x 1050	65.22	60.00	122.61	D/H/DL
1400 x 1050/75	1400 x 1050	82.20	75.00	155.85	R/Y/D/H/DL
1440 x 900/60	1440 x 900	55.47	59.90	88.75	R/Y/D/H/DL
	1440 x 900	55.92	60.00	106.47	R/Y/D/H/DL
1600 x 900/50	1600 x 900	46.30	50.00	97.05	D/H/DL
1600 x 900/60	1600 x 900	60.00	60.00	108.00	D/H/DL
	1600 x 900	55.99	59.95	118.25	D/H/DL
	1600 x 900	55.92	60.00	119.00	D/H/DL
1680 x 1050/60	1680 x 1050	65.29	59.95	146.25	R/Y/D/H/DL
1600 x 1200/60	1600 x 1200 ^{*3}	75.00	60.00	162.00	R/Y/D/H/DL
1920 x 1080/60	1920 x 1080 ^{*4}	66.59	59.93	138.50	R/Y/D/H/DL
	1920 x 1080	67.50	60.00	148.50	R/Y/D/H/DL
1920 x 1200/60	1920 x 1200 ^{*3}	74.04	59.95	154.00	R/Y/D/H/DL

● The signal format distinguished automatically will be sometimes indication different from an actual input signal.

*1: When 1125 (1035) /60i signal is input, it is displayed as 1125 (1080) /60i signal. *3: Displayed with image elements thinned out in the image processing circuit.

*2: Pixel-Repetition signal (dot clock frequency 27.0 MHz) only

*4: Based on VESA CVT-RB (Reduced Blanking) standard

Drawing of terminals

View from back

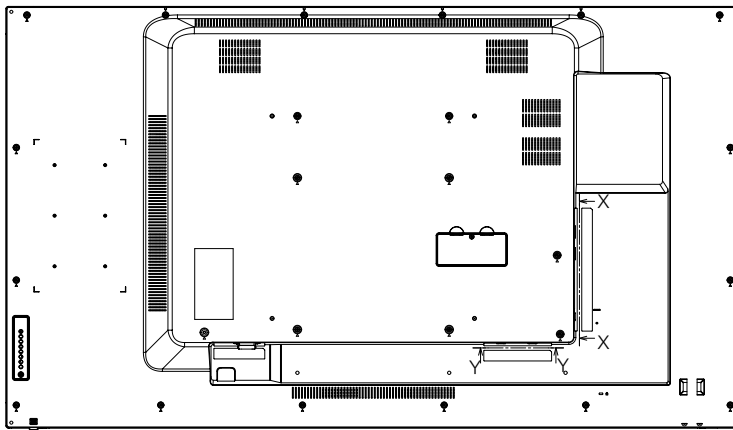

Magnified figure of terminal a

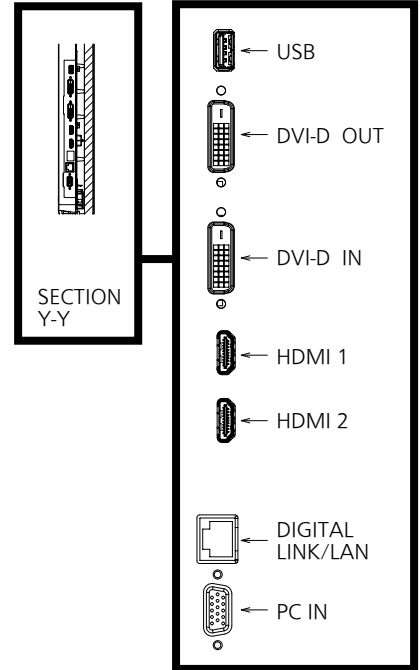

Magnified figure of terminal b

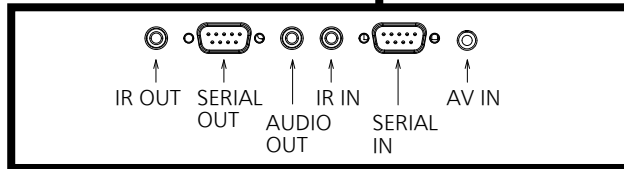

Sectional view of terminal a (USB/DVI-D OUT/DVI-D IN/HDMI 1,2/DIGITAL LINK LAN/PC IN)

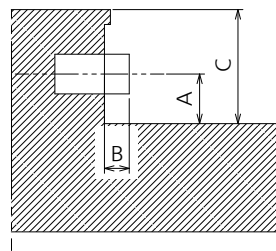

Terminal a
65SF2W Terminal (Side)

Units : mm

	USB	DVI-D IN/OUT	HDMI	DIGITAL LINK/LAN	PC IN
A	7.8	8.8	7.2	8.8	10
B		5.6			5.3
C			30.2		

Sectional view of terminal b (IR OUT/SERIAL OUT/AUDIO OUT/IR IN/SERIAL IN/AV IN)

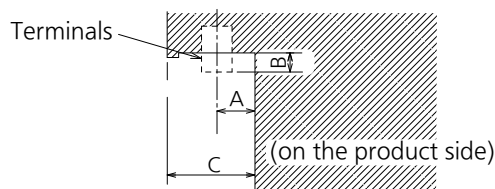

Terminal b
65SF2W Terminal (Bottom)

Units : mm

	IR IN/OUT	SERIAL OUT	AUDIO OUT	SERIAL IN	AV IN
A	2.7	5.2	2.7	5.2	1.7
B	10.1	10.1	10.1	10.1	9.3
C			30.2		

*Due to the construction of terminal, some types of connecting cable or USB memory device cannot be used. Be sure to use connecting cable or USB memory device after confirmation in this drawing.

● Installation precautions

The SF2 Series is designed for use in either portrait or horizontal orientation with angle adjustment. Tilting installation up to 45 degrees forward or backward is also possible. You can install as shown the example figures.

Orientation	Landscape (The angle can be adjusted up to 45 degrees for each right and left (with the display installed landscape).)
Tilting angle	0 - 45 degrees forward / backward with landscape / portrait setting (Angle adjustment is not possible for forward / backward tilting installation.)

◆ Orientation

Angle adjustment (0-45° for both left and right)

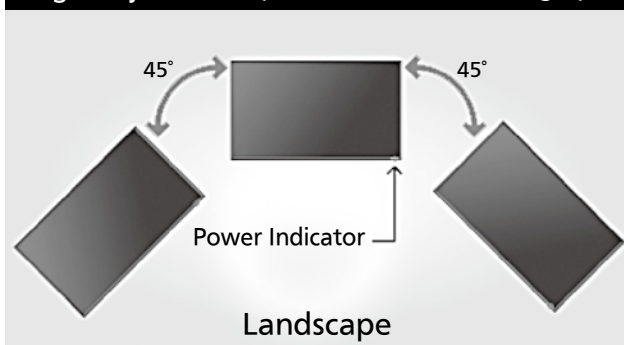

◆ Tilting angle

Forward tilting

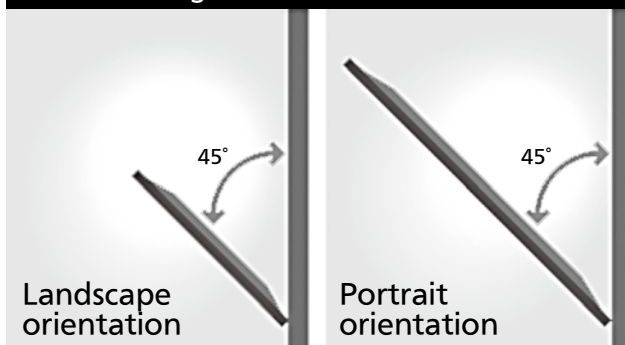

Backward tilting

