

## Operating Instructions Functional Manual

LCD Projector Commercial Use

Model No. **PT-VZ470**

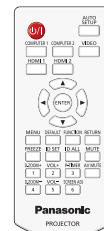
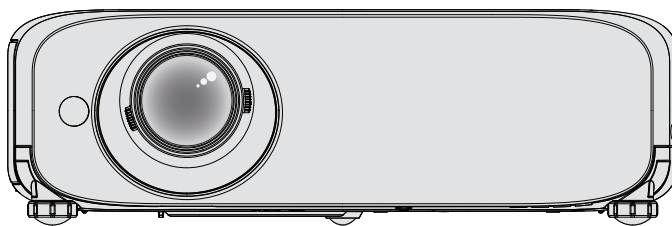

Thank you for purchasing this Panasonic product.

- This manual is intended for products manufactured from Aug. 2018 and beyond.
- This manual is common to all the models regardless of suffixes of the Model No.
  - for India  
PT-VZ470D
  - for other countries or regions  
PT-VZ470
- Before operating this product, please read the instructions carefully, and save this manual for future use.
- Before using your projector, be sure to read “Read this first!” (➡ pages 4 to 13).

# Contents

## Read this first! ..... 4

## Chapter 1 Preparation

<b>Precautions for use</b> .....	<b>17</b>
Cautions when transporting.....	17
Cautions when installing.....	17
Security .....	18
Cautions on use .....	19
Storage.....	19
Disposal.....	19
Accessories .....	20
Contents of the supplied CD-ROM.....	21
Optional accessories .....	21
<b>About your projector</b> .....	<b>22</b>
Remote control .....	22
Projector body .....	23
<b>Preparing the remote control</b> .....	<b>26</b>
Inserting and removing batteries .....	26
When using the system with multiple projectors ..	26
<b>Attaching the lens cap</b> .....	<b>27</b>

## Chapter 2 Getting Started

<b>Setting up</b> .....	<b>29</b>
Installation mode .....	29
Parts for ceiling mount (optional).....	29
Screen size and throw distance .....	30
Adjusting adjustable feet .....	31
Adjusting the position using the vertical lens shift function .....	31
<b>Connecting</b> .....	<b>33</b>
Before connecting .....	33
Connecting example : AV equipment .....	34
Connecting example : Computers .....	35

## Chapter 3 Basic Operations

<b>Powering on/off the projector</b> .....	<b>37</b>
Connecting the power cord .....	37
Power indicator.....	37
Powering On the Projector .....	38
When the initial setting screen is displayed .....	38
Making adjustments and selections .....	39
Powering Off the Projector .....	40
Direct Power Off function .....	40
<b>Projecting</b> .....	<b>41</b>
Selecting the input signal .....	41
How to adjust the state of the image .....	41
<b>Basic operations by using the remote control</b> .....	<b>42</b>
Using the AUTO SETUP function.....	42
Using the SCREEN ADJ button.....	42
Controlling the volume of the speaker.....	43

Using the FUNCTION button.....	43
Switching the input signal.....	43
Using the DIGITAL ZOOM function .....	44
Using the FREEZE function .....	44
Using the AV MUTE function .....	45
Using the P-TIMER function.....	45
Using the MUTE function .....	45
Setting the ID number of the remote control .....	45

## Chapter 4 Settings

<b>Menu Navigation</b> .....	<b>48</b>
Navigating through the menu .....	48
Resetting adjustment values to the factory default .....	49
Main menu.....	49
Sub menu .....	49
<b>[PICTURE] menu</b> .....	<b>52</b>
[PICTURE MODE].....	52
[CONTRAST].....	52
[BRIGHTNESS].....	52
[COLOR].....	53
[TINT] .....	53
[SHARPNESS] .....	53
[COLOR TEMPERATURE].....	53
[IRIS] .....	54
[ADVANCED MENU] .....	54
[DAYLIGHT VIEW].....	54
[DIGITAL CINEMA REALITY] .....	55
[NOISE REDUCTION].....	55
[TV-SYSTEM] .....	55
[RGB/YP <sub>B</sub> P <sub>R</sub> ] / [RGB/YC <sub>B</sub> C <sub>R</sub> ] .....	55
<b>[POSITION] menu</b> .....	<b>57</b>
[REALTIME KEYSTONE] .....	57
[SCREEN ADJUSTMENT] .....	57
[SHIFT] .....	61
[DOT CLOCK].....	61
[CLOCK PHASE].....	61
[OVER SCAN] .....	62
[ASPECT] .....	62
[FRAME LOCK] .....	63
<b>[LANGUAGE] menu</b> .....	<b>64</b>
[LANGUAGE] .....	64
<b>[DISPLAY OPTION] menu</b> .....	<b>65</b>
[ON-SCREEN DISPLAY].....	65
[HDMI SIGNAL LEVEL].....	66
[CLOSED CAPTION SETTING] (Only for NTSC, 480i YC <sub>B</sub> C <sub>R</sub> input) .....	66
[SCREEN SETTING] .....	67
[STARTUP LOGO].....	68
[AUTO SETUP SETTING].....	68
[SIGNAL SEARCH] .....	68
[BACK COLOR].....	68
[WIDE MODE] .....	69

## Contents

[SXGA MODE].....	69	<b>Dimensions</b> .....	<b>116</b>
[P-TIMER].....	69	<b>Ceiling mount bracket safeguards</b> .....	<b>117</b>
[OTHER FUNCTIONS].....	70	<b>Index</b> .....	<b>118</b>
<b>[PROJECTOR SETUP] menu</b> .....	<b>71</b>		
[STATUS].....	71		
[COMPUTER1 INPUT SETTING].....	71		
[COMPUTER2 SELECT].....	71		
[PROJECTOR ID].....	72		
[INITIAL START UP].....	72		
[PROJECTION METHOD].....	72		
[LAMP POWER] .....	72		
[ECO MANAGEMENT].....	73		
[EMULATE].....	74		
[FUNCTION BUTTON] .....	74		
[AUDIO SETTING] .....	75		
[TEST PATTERN] .....	76		
[FILTER COUNTER].....	77		
[INITIALIZE ALL] .....	77		
<b>[SECURITY] menu</b> .....	<b>78</b>		
[PASSWORD].....	78		
[PASSWORD CHANGE] .....	78		
[TEXT DISPLAY] .....	79		
[TEXT CHANGE].....	79		
[MENU LOCK].....	79		
[MENU LOCK PASSWORD] .....	79		
[CONTROL DEVICE SETUP].....	80		
<b>[NETWORK] menu</b> .....	<b>81</b>		
[WIRED LAN] .....	81		
[NAME CHANGE].....	81		
[NETWORK CONTROL] .....	82		
[AMX D. D.] .....	82		
[Crestron Connected(TM)].....	82		
[STATUS].....	82		
[INITIALIZE].....	82		
Network connections .....	83		
Accessing from the web browser .....	84		

## Chapter 5 Maintenance

<b>Lamp and temperature indicators</b> .....	<b>99</b>
When an indicator lights up .....	99
<b>Maintenance/replacement</b> .....	<b>100</b>
Before performing maintenance/replacement ....	100
Maintenance .....	100
Replacing the unit.....	100
<b>Troubleshooting</b> .....	<b>104</b>

## Chapter 6 Appendix

<b>Technical information</b> .....	<b>106</b>
PJLink protocol.....	106
Control commands via LAN.....	107
<SERIAL IN> terminal .....	109
[MENU LOCK PASSWORD] operations .....	111
List of compatible signals .....	112
<b>Specifications</b> .....	<b>114</b>

# Read this first!

**WARNING:** THIS APPARATUS MUST BE EARTHED.

**WARNING:** To prevent damage which may result in fire or shock hazard, do not expose this appliance to rain or moisture.  
This device is not intended for use in the direct field of view at visual display workplaces. To avoid incommoding reflexions at visual display workplaces this device must not be placed in the direct field of view.  
The equipment is not intended for used at a video workstation in compliance BildscharbV.  
The sound pressure level at the operator position is equal or less than 70 dB (A) according to ISO 7779.

**WARNING:**

1. Remove the plug from the mains socket when this unit is not in use for a prolonged period of time.
2. To prevent electric shock, do not remove cover. No user serviceable parts inside. Refer servicing to qualified service personnel.
3. Do not remove the earthing pin on the mains plug. This apparatus is equipped with a three prong earthing type mains plug. This plug will only fit an earthing-type mains socket. This is a safety feature. If you are unable to insert the plug into the mains socket, contact an electrician. Do not defeat the purpose of the earthing plug.

**WARNING:**

This equipment is compliant with Class A of CISPR32.  
In a residential environment this equipment may cause radio interference.

**WARNING:** TO REDUCE THE RISK OF FIRE OR ELECTRIC SHOCK, DO NOT EXPOSE THIS PRODUCT TO RAIN OR MOISTURE.



The lightning flash with arrowhead symbol, within an equilateral triangle, is intended to alert the user to the presence of uninsulated “dangerous voltage” within the product’s enclosure that may be of sufficient magnitude to constitute a risk of electric shock to persons.



The exclamation point within an equilateral triangle is intended to alert the user to the presence of important operating and maintenance (servicing) instructions in the literature accompanying the product.

**WARNING:**

TURN THE POWER OFF AND DISCONNECT THE POWER PLUG FROM THE WALL OUTLET BEFORE REPLACING THE LAMP UNIT.



**CAUTION:** To assure continued compliance, follow the attached installation instructions. This includes using the provided power cord and shielded interface cables when connecting to computer or peripheral devices. Also, any unauthorized changes or modifications to this equipment could void the user's authority to operate this device.

This is a device to project images onto a screen, etc., and is not intended for use as indoor lighting in a domestic environment.

Directive 2009/125/EC

**Read this first!**

**WARNING:**

- Not for use in a computer room as defined in the Standard for the Protection of Electronic Computer/Data Processing Equipment, ANSI/NFPA 75.
- For permanently connected equipment, a readily accessible disconnect device shall be incorporated in the building installation wiring.
- For pluggable equipment, the socket-outlet shall be installed near the equipment and shall be easily accessible.

**CAUTION (North/Middle/South America)**

**CAUTION:** This equipment is equipped with a three-pin grounding-type power plug. Do not remove the grounding pin on the power plug. This plug will only fit a grounding-type power outlet. This is a safety feature. If you are unable to insert the plug into the outlet, contact an electrician. Do not defeat the purpose of the grounding plug.

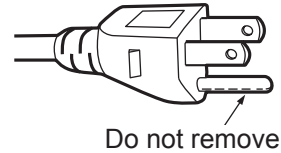

**FCC NOTICE (USA)**

**Verification**

Model Number : PT-VZ470  
Trade Name : Panasonic  
Responsible Party : Panasonic Corporation of North America  
Address : Two Riverfront Plaza, Newark, NJ 07102-5490  
General Contact : <http://www.panasonic.com/support>  
Projector Contact : <https://panasonic.net/cns/projector/>

This device complies with Part 15 of the FCC Rules. Operation is subject to the following two conditions: (1) This device may not cause harmful interference, and (2) this device must accept any interference received, including interference that may cause undesired operation.

**Caution:**

This equipment has been tested and found to comply with the limits for a Class A digital device, pursuant to Part 15 of the FCC Rules. These limits are designed to provide reasonable protection against harmful interference when the equipment is operated in a commercial environment. This equipment generates, uses and can radiate radio frequency energy and, if not installed and used in accordance with the instructions manual, may cause harmful interference to radio communications. Operation of this equipment in a residential area is likely to cause harmful interference in which case the user will be required to correct the interference at his own expense.

**FCC Warning:**

To assure continued compliance, follow the attached installation instructions. This includes using the provided power cord and shielded interface cables when connecting to computer or peripheral devices. Also, any unauthorized changes or modifications to this equipment could void the user's authority to operate this device.

**NOTIFICATION (Canada)**

This class A digital apparatus complies with Canadian ICES-003.

**Contains mercury / Contenu avec mercure**

For more information on safe handling procedures, the measures to be taken in case of accidental breakage and safe disposal options visit:  
[ec.gc.ca/mercure-mercury/](http://ec.gc.ca/mercure-mercury/).  
Dispose of or recycle in accordance with applicable laws.

Pour plus de renseignements sur les procédures de manutention sécuritaire, les mesures à prendre en cas de bris accidentel et les options d'élimination sécuritaire visitez:  
[ec.gc.ca/mercure-mercury/](http://ec.gc.ca/mercure-mercury/).  
Mettez au rebut ou recyclez conformément aux lois applicables.



**Notice (USA only):**

- This product has a High Intensity Discharge (HID) lamp that contains mercury. Disposal may be regulated in your community due to environmental considerations. For disposal or recycling information, please visit website: <https://holdings.panasonic/global/corporate/sustainability.html> or call 1-888-769-0149.

**IMPORTANT: THE MOULDED PLUG (U.K. only)**

FOR YOUR SAFETY, PLEASE READ THE FOLLOWING TEXT CAREFULLY.

This appliance is supplied with a moulded three pin mains plug for your safety and convenience. A 13 amp fuse is fitted in this plug. Should the fuse need to be replaced, please ensure that the replacement fuse has a rating of 13 amps and that it is approved by ASTA or BSI to BS1362.

Check for the ASTA mark  or the BSI mark  on the body of the fuse.

If the plug contains a removable fuse cover, you must ensure that it is refitted when the fuse is replaced. If you lose the fuse cover, the plug must not be used until a replacement cover is obtained. A replacement fuse cover can be purchased from an Authorised Service Center.

If the fitted moulded plug is unsuitable for the mains socket in your home, then the fuse should be removed and the plug cut off and disposed of safely. There is a danger of severe electrical shock if the cut off plug is inserted into any 13 amp socket.

If a new plug is to be fitted, please observe the wiring code as shown below.  
If in any doubt, please consult a qualified electrician.

**WARNING:**        THIS APPLIANCE MUST BE EARTHED.

**IMPORTANT:**        The wires in this mains lead are coloured in accordance with the following code:

Green - and - Yellow:	Earth
Blue:	Neutral
Brown:	Live

As the colours of the wire in the mains lead of this appliance may not correspond with the coloured markings identifying the terminals in your plug, proceed as follows.

The wire which is coloured GREEN - AND - YELLOW must be connected to the terminal in the plug which is marked with the letter E or by the Earth symbol  or coloured GREEN or GREEN - AND - YELLOW.

The wire which is coloured BLUE must be connected to the terminal in the plug which is marked with the letter N or coloured BLACK.

The wire which is coloured BROWN must be connected to the terminal in the plug which is marked with the letter L or coloured RED.

How to replace the fuse: Open the fuse compartment with a screwdriver and replace the fuse.

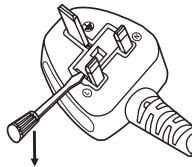

## Contents

English	<p><b>Manufactured by:</b> Panasonic Connect Co., Ltd. 4-1-62 Minoshima, Hakata-ku, Fukuoka 812-8531, Japan</p> <p><b>Importer:</b> Panasonic Connect Europe GmbH</p> <p><b>Authorized Representative in EU:</b> Panasonic Testing Centre Winsbergring 15, 22525 Hamburg, Germany</p> <p><b>Importer for UK:</b> Panasonic Connect UK, a branch of Panasonic Connect Europe GmbH, Maxis 2, Western Road, Bracknell, Berkshire, RG12 1RT</p>	
Français	<p><b>Fabriqué par:</b> Panasonic Connect Co., Ltd. 4-1-62 Minoshima, Hakata-ku, Fukuoka 812-8531, Japon</p> <p><b>Importateur:</b> Panasonic Connect Europe GmbH</p> <p><b>Représentant autorisé dans l'UE:</b> Panasonic Testing Centre Winsbergring 15, 22525 Hambourg, Allemagne</p>	
Español	<p><b>Fabricado por:</b> Panasonic Connect Co., Ltd. 4-1-62 Minoshima, Hakata-ku, Fukuoka 812-8531, Japón</p> <p><b>Importador:</b> Panasonic Connect Europe GmbH</p> <p><b>Representante Autorizado para la UE:</b> Panasonic Testing Centre Winsbergring 15, 22525 Hamburgo, Alemania</p>	
Deutsch	<p><b>Hergestellt von:</b> Panasonic Connect Co., Ltd. 4-1-62 Minoshima, Hakata-ku, Fukuoka 812-8531, Japan</p> <p><b>Importeur:</b> Panasonic Connect Europe GmbH</p> <p><b>Vertretungsberechtigter in der EU:</b> Panasonic Testing Centre Winsbergring 15, 22525 Hamburg, Deutschland</p>	
Italiano	<p><b>Fabbricato da:</b> Panasonic Connect Co., Ltd. 4-1-62 Minoshima, Hakata-ku, Fukuoka 812-8531, Giappone</p> <p><b>Importatore:</b> Panasonic Connect Europe GmbH</p> <p><b>Rappresentante autorizzato nell'UE:</b> Panasonic Testing Centre Winsbergring 15, 22525 Amburgo, Germania</p>	
Български	<p><b>Производител:</b> Panasonic Connect Co., Ltd. 4-1-62 Minoshima, Hakata-ku, Fukuoka 812-8531, Япония</p> <p><b>Вносител:</b> Panasonic Connect Europe GmbH</p> <p><b>Упълномощен представител в ЕС:</b> Panasonic Testing Centre Winsbergring 15, 22525 Hamburg, Германия</p>	
Čeština	<p><b>Vyrobil:</b> Panasonic Connect Co., Ltd. 4-1-62 Minoshima, Hakata-ku, Fukuoka 812-8531, Japonsko</p> <p><b>Dovozce:</b> Panasonic Connect Europe GmbH</p> <p><b>Oprávněný zástupce v EU:</b> Panasonic Testing Centre Winsbergring 15, 22525 Hamburk, Německo</p>	
Dansk	<p><b>Fremstillet af:</b> Panasonic Connect Co., Ltd. 4-1-62 Minoshima, Hakata-ku, Fukuoka 812-8531, Japan</p> <p><b>Importør:</b> Panasonic Connect Europe GmbH</p> <p><b>Autoriseret repræsentant i EU:</b> Panasonic Testing Centre Winsbergring 15, 22525 Hamburg, Tyskland</p>	
Eesti	<p><b>Tootja:</b> Panasonic Connect Co., Ltd. 4-1-62 Minoshima, Hakata-ku, Fukuoka 812-8531, Jaapan</p> <p><b>Maaletooja:</b> Panasonic Connect Europe GmbH</p> <p><b>Volitatud esindaja ELis:</b> Panasonic Testing Centre Winsbergring 15, 22525 Hamburg, Saksamaa</p>	

## Contents

Ελληνικά	<p><b>Κατασκευάστηκε από:</b> Panasonic Connect Co., Ltd. 4-1-62 Minoshima, Hakata-ku, Fukuoka 812-8531, Ιαπωνία</p> <p><b>Εισαγωγέας:</b> Panasonic Connect Europe GmbH</p> <p><b>Εξουσιοδοτημένος αντιπρόσωπος στην ΕΕ:</b> Panasonic Testing Centre Winsbergring 15, 22525 Hamburg, Γερμανία</p>
Hrvatski	<p><b>Proizvodi:</b> Panasonic Connect Co., Ltd. 4-1-62 Minoshima, Hakata-ku, Fukuoka 812-8531, Japan</p> <p><b>Uvoznik:</b> Panasonic Connect Europe GmbH</p> <p><b>Ovlašteni zastupnik u EU-u:</b> Panasonic Testing Centre Winsbergring 15, 22525 Hamburg, Njemačka</p>
Latviešu	<p><b>Ražotājs:</b> Panasonic Connect Co., Ltd. 4-1-62 Minoshima, Hakata-ku, Fukuoka 812-8531, Japāna</p> <p><b>Importētājs:</b> Panasonic Connect Europe GmbH</p> <p><b>Oficiālais pārstāvis ES:</b> Panasonic Testing Centre Winsbergring 15, 22525 Hamburg, Vācija</p>
Lietuvių	<p><b>Gamintojas:</b> Panasonic Connect Co., Ltd. 4-1-62 Minoshima, Hakata-ku, Fukuoka 812-8531, Japonija</p> <p><b>Importuotojas:</b> Panasonic Connect Europe GmbH</p> <p><b>Igaliotasis atstovas ES:</b> Panasonic Testing Centre Winsbergring 15, 22525 Hamburgas, Vokietija</p>
Magyar	<p><b>Gyártotta:</b> Panasonic Connect Co., Ltd. 4-1-62 Minoshima, Hakata-ku, Fukuoka 812-8531, Japán</p> <p><b>Importőr:</b> Panasonic Connect Europe GmbH</p> <p><b>Hivatalos képviselő az EU-ban:</b> Panasonic Testing Centre Winsbergring 15, 22525 Hamburg, Németország</p>
Nederlands	<p><b>Geproduceerd door:</b> Panasonic Connect Co., Ltd. 4-1-62 Minoshima, Hakata-ku, Fukuoka 812-8531, Japan</p> <p><b>Importeur:</b> Panasonic Connect Europe GmbH</p> <p><b>Bevoegde vertegenwoordiger in de EU:</b> Panasonic Testing Centre Winsbergring 15, 22525 Hamburg, Duitsland</p>
Norsk	<p><b>Produsert av:</b> Panasonic Connect Co., Ltd. 4-1-62 Minoshima, Hakata-ku, Fukuoka 812-8531, Japan</p> <p><b>Importør:</b> Panasonic Connect Europe GmbH</p> <p><b>Autorisert representant i EU:</b> Panasonic Testing Centre Winsbergring 15, 22525 Hamburg, Tyskland</p>
Polski	<p><b>Wyprodukowano przez:</b> Panasonic Connect Co., Ltd. 4-1-62 Minoshima, Hakata-ku, Fukuoka 812-8531, Japonia</p> <p><b>Importer:</b> Panasonic Connect Europe GmbH</p> <p><b>Upoważniony przedstawiciel w UE:</b> Panasonic Testing Centre Winsbergring 15, 22525 Hamburg, Niemcy</p>
Português	<p><b>Fabricado por:</b> Panasonic Connect Co., Ltd. 4-1-62 Minoshima, Hakata-ku, Fukuoka 812-8531, Japão</p> <p><b>Importador:</b> Panasonic Connect Europe GmbH</p> <p><b>Representante Autorizado na UE:</b> Panasonic Testing Centre Winsbergring 15, 22525 Hamburgo, Alemanha</p>
Română	<p><b>Fabricat de:</b> Panasonic Connect Co., Ltd. 4-1-62 Minoshima, Hakata-ku, Fukuoka 812-8531, Japonia</p> <p><b>Importator:</b> Panasonic Connect Europe GmbH</p> <p><b>Reprezentant autorizat în UE:</b> Panasonic Testing Centre Winsbergring 15, 22525 Hamburg, Germania</p>



## Contents

Slovenčina	<p><b>Výrobca:</b> Panasonic Connect Co., Ltd. 4-1-62 Minoshima, Hakata-ku, Fukuoka 812-8531, Japonsko</p> <p><b>Dovozca:</b> Panasonic Connect Europe GmbH</p> <p><b>Autorizovaný zástupca v EÚ:</b> Panasonic Testing Centre Winsbergring 15, 22525 Hamburg, Nemecko</p>
Slovenščina	<p><b>Proizvajaja:</b> Panasonic Connect Co., Ltd. 4-1-62 Minoshima, Hakata-ku, Fukuoka 812-8531, Japonska</p> <p><b>Uvoznik:</b> Panasonic Connect Europe GmbH</p> <p><b>Pooblaščen zastopnik v EÚ:</b> Panasonic Testing Centre Winsbergring 15, 22525 Hamburg, Nemčija</p>
Suomi	<p><b>Valmistaja:</b> Panasonic Connect Co., Ltd. 4-1-62 Minoshima, Hakata-ku, Fukuoka 812-8531, Japani</p> <p><b>Maahantuoja:</b> Panasonic Connect Europe GmbH</p> <p><b>Valtuutettu edustaja EU:ssa:</b> Panasonic Testing Centre Winsbergring 15, 22525 Hampuri, Saksa</p>
Svenska	<p><b>Tillverkad av:</b> Panasonic Connect Co., Ltd. 4-1-62 Minoshima, Hakata-ku, Fukuoka 812-8531, Japan</p> <p><b>Importör:</b> Panasonic Connect Europe GmbH</p> <p><b>Auktoriserad representant i EU:</b> Panasonic Testing Centre Winsbergring 15, 22525 Hamburg, Tyskland</p>
Türkçe	<p><b>Tarafından Üretilmiştir:</b> Panasonic Connect Co., Ltd. 4-1-62 Minoshima, Hakata-ku, Fukuoka 812-8531, Japonya</p> <p><b>İthalatçı:</b> Panasonic Connect Europe GmbH</p> <p><b>AB Yetkili Temsilcisi:</b> Panasonic Testing Centre Winsbergring 15, 22525 Hamburg, Almanya</p>

## To remove the battery

1. Press the guide and lift the cover.

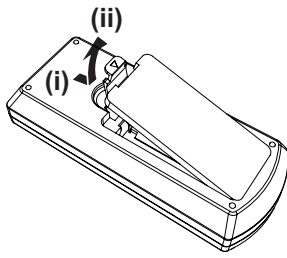

2. Remove the batteries.

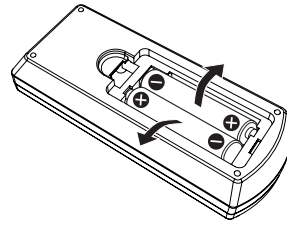

## Brazil Only Brasil Apenas

### Manuseio de baterias usadas



#### BRASIL

Após o uso, as pilhas e /ou baterias deverão ser entregues ao estabelecimento comercial ou rede de assistência técnica autorizada.

Cobrir os terminais positivo (+) e negativo (-) com uma fita isolante adesiva, antes de depositar numa caixa destinada para o recolhimento. O contato entre partes metálicas pode causar vazamentos, gerar calor, romper a blindagem e produzir fogo. (Fig. 1)

Fig. 1  
Como isolar os terminais

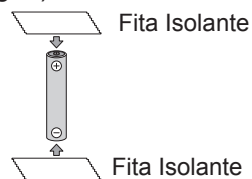

Não desmonte, não remova o invólucro, nem amasse a bateria. O gás liberado pela bateria pode irritar a garganta, danificar o lacre do invólucro ou o vazamento provocar calor, ruptura da blindagem e produzir fogo devido ao curto circuito dos terminais. Não incinere nem aqueça as baterias, elas não podem ficar expostas a temperaturas superiores a 100 °C (212 °F). O gás liberado pela bateria pode irritar a garganta, danificar o lacre do invólucro ou o vazamento provocar calor, ruptura da blindagem e produzir fogo devido ao curto circuito dos terminais provocado internamente.

Evite o contato com o líquido que vazar das baterias. Caso isto ocorra, lave bem a parte afetada com bastante água. Caso haja irritação, consulte um médico.

### Remoção das baterias

1. Pressione a guia e levante a tampa.

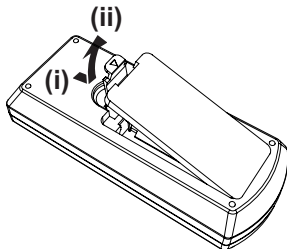

2. Remova as baterias.

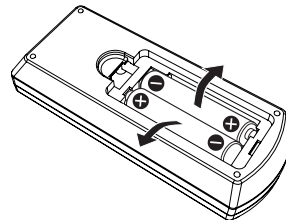

## **WARNING:**

### **■ POWER**

**The wall outlet or the circuit breaker shall be installed near the equipment and shall be easily accessible when problems occur. If the following problems occur, cut off the power supply immediately.**

Continued use of the projector in these conditions will result in fire or electric shock.

- If foreign objects or water get inside the projector, cut off the power supply.
  - If the projector is dropped or the cabinet is broken, cut off the power supply.
  - If you notice smoke, strange smells or noise coming from the projector, cut off the power supply.
- Please contact an Authorized Service Center for repairs, and do not attempt to repair the projector yourself.

**During a thunderstorm, do not touch the projector or the cable.**

Electric shocks can result.

**Do not do anything that might damage the power cord or the power plug.**

If the power cord is used while damaged, electric shocks, short-circuits or fire will result.

- Do not damage the power cord, make any modifications to it, place it near any hot objects, bend it excessively, twist it, pull it, place heavy objects on top of it or wrap it into a bundle.

Ask an Authorized Service Center to carry out any repairs to the power cord that might be necessary.

**Completely insert the power plug into the wall outlet and the power connector into the projector terminal.**

If the plug is not inserted correctly, electric shocks or overheating will result.

- Do not use plugs which are damaged or wall outlets which are coming loose from the wall.

**Do not use anything other than the provided power cord.**

Failure to observe this will result in fire or electric shocks. Please note that if you do not use the provided power cord to ground the device on the side of the outlet, this may result in electric shocks.

**Clean the power plug regularly to prevent it from becoming covered in dust.**

Failure to observe this will cause a fire.

- If dust builds up on the power plug, the resulting humidity can damage the insulation.
  - If not using the projector for an extended period of time, pull the power plug out from the wall outlet.
- Pull the power plug out from the wall outlet and wipe it with a dry cloth regularly.

**Do not handle the power plug and power connector with wet hands.**

Failure to observe this will result in electric shocks.

**Do not overload the wall outlet.**

If the power supply is overloaded (ex., by using too many adapters), overheating may occur and fire will result.

### **■ ON USE/INSTALLATION**

**Do not place the projector on soft materials such as carpets or sponge mats.**

Doing so will cause the projector to overheat, which can cause burns, fire or damage to the projector.

**Do not set up the projector in humid or dusty places or in places where the projector may come into contact with oily smoke or steam, ex. a bathroom.**

Using the projector under such conditions will result in fire, electric shocks or components deterioration. Components deterioration (such as ceiling mount brackets) may cause the projector which is mounted on the ceiling to fall down.

**Do not install this projector in a place which is not strong enough to take the full weight of the projector or on top of a surface which is sloped or unstable.**

Failure to observe this will cause projector to fall down or tip over the projector, and severe injury or damage could result.

**Installation work (such as ceiling mount bracket) should only be carried out by a qualified technician.**

If installation is not carried out and secured correctly, it can cause injury or accidents, such as electric shocks.

- Be sure to use the wire provided with the ceiling mount bracket as an extra safety measure to prevent the projector from falling down. (Install in a different location to the ceiling mount bracket.)

**Do not cover the air intake/exhaust ports.**

Doing so will cause the projector to overheat, which can cause fire or damage to the projector.

- Do not place the projector in narrow, badly ventilated places.
- Do not place the projector on cloth or papers, as these materials could be drawn into the air intake port.
- Provide at least 1 m (40") of space between any walls or objects and the exhaust port, and at least 50 cm (20") of space between any walls or objects and the intake port.

**Do not place your hands or other objects close to the air exhaust port.**

Doing so will cause burns or damage your hands or other objects.

**WARNING:**

- Heated air comes out of the air exhaust port. Do not place your hands or face, or objects which cannot withstand heat close to this port.

**Do not look and place your skin into the lights emitted from the lens while the projector is being used.**

Doing so can cause burns or loss of sight.

- Strong light is emitted from the projector's lens. Do not look or place your hands directly into this light.
- Be especially careful not to let young children look into the lens. In addition, turn off the power and disconnect the power plug when you are away from the projector.

**Never attempt to remodel or disassemble the projector.**

High voltages can cause fire or electric shocks.

- For any inspection, adjustment and repair work, please contact an Authorized Service Center.

**Do not allow metal objects, flammable objects, or liquids to enter inside of the projector. Do not allow the projector to get wet.**

Doing so may cause short circuits or overheating, and result in fire, electric shock, or malfunction of the projector.

- Do not place containers of liquid or metal objects near the projector.
- If liquid enters inside of the projector, consult your dealer.
- Particular attention must be paid to children.

**Use the ceiling mount bracket specified by Panasonic Connect Co., Ltd.**

Defects in the ceiling mount bracket will result in falling accidents.

- Attach the supplied safety cable to the ceiling mount bracket to prevent the projector from falling down.

**■ ACCESSORIES**

**Do not use or handle the batteries improperly, and refer to the following.**

Failure to observe this will cause burns, batteries to leak, overheat, explode or catch fire.

- Do not use unspecified batteries.
- Do not use chargeable batteries.
- Do not disassemble dry cell batteries.
- Do not heat the batteries or place them into water or fire.
- Do not allow the + and - terminals of the batteries to come into contact with metallic objects such as necklaces or hairpins.
- Do not store or carry batteries together with metallic objects.
- Store the batteries in a plastic bag and keep them away from metallic objects.
- Make sure the polarities (+ and -) are correct when inserting the batteries.
- Do not use a new battery together with an old battery or mix different types of batteries.
- Do not use batteries with the outer cover peeling away or removed.

**Do not allow children to reach the batteries.**

Accidentally swallowing them can cause physical harm.

- If swallowed, seek medical advice immediately.

**If the battery fluid leaks, do not touch it with bare hands, and take the following measures if necessary.**

- Battery fluid on your skin or clothing could result in skin inflammation or injury.  
Rinse with clean water and seek medical advice immediately.
- Battery fluid coming in contact with your eyes could result in loss of sight.  
In this case, do not rub your eyes. Rinse with clean water and seek medical advice immediately.

**Do not disassemble the lamp unit.**

If the lamp breaks, it could cause injury.

**Lamp replacement**

The lamp has high internal pressure. If improperly handled, an explosion and severe injury or accidents will result.

- The lamp can easily explode if struck against hard objects or dropped.
- Before replacing the lamp unit, be sure to turn the power off and to disconnect the power plug from the wall outlet. Electric shocks or explosions can result if this is not done.
- When replacing the lamp, turn the power off and allow the lamp to cool for at least 1 hour before handling it otherwise it can cause burns.

**Do not use the supplied power cord with devices other than this projector.**

- Using the supplied power cord with devices other than this projector may cause short circuits or overheating, and result in electric shock or fire.

**Remove the depleted batteries from the remote control promptly.**

- Leaving them in the unit may result in fluid leakage, overheating, or explosion of the batteries

## **CAUTION:**

### **■ POWER**

**When disconnecting the power cord, be sure to hold the power plug and power connector.**

If the power cord itself is pulled, the lead will become damaged, and fire, short-circuits or serious electric shocks will result.

**When not using the projector for an extended period of time, disconnect the power plug from the wall outlet.**

Failure to do so may result in fire or electric shock.

**Disconnect the power plug from the wall outlet before carrying out any cleaning and replacing the unit.**

Failure to do so may result in electric shock.

### **■ ON USE/INSTALLATION**

**Do not place heavy objects on top of the projector.**

Failure to observe this will cause the projector to become unbalanced and fall, which could result in damage or injury. The projector will be damaged or deformed.

**Do not put your weight on this projector.**

You could fall or the projector could break, and injury will result.

- Be especially careful not to let young children stand or sit on the projector.

**Do not place the projector in extremely hot locations.**

Doing so will cause the outer casing or internal components to deteriorate, or result in fire.

- Take particular care in locations exposed to direct sunlight or near stoves.

**Do not install the projector in a location where salt pollution or corrosive gas may occur.**

Doing so may result in falling due to corrosion. Also, it may result in malfunctions.

**Do not place objects in front of the lens while the projector is being used.**

Doing so can cause fire or damage to the object and can cause the projector to malfunction.

- Extremely strong light is emitted from the projector's lens.

**Do not stand in front of the lens while the projector is being used.**

Doing so can cause damage and burns to clothing.

- Extremely strong light is emitted from the projector's lens.

**Always disconnect all cables before moving the projector.**

Moving the projector with cables still attached can damage the cables, which will cause fire or electric shocks to occur.

**When mounting the projector on the ceiling, keep mounting screws and power cord from contact with metal parts inside the ceiling.**

Contact with metal parts inside the ceiling can cause electric shocks.

**Never plug headphones and earphones into <VARIABLE AUDIO OUT> terminal.**

Excessive sound pressure from earphones and headphones can cause hearing loss.

### **■ ACCESSORIES**

**Do not use the old lamp unit.**

If used it could cause lamp explosion.

**If the lamp has broken, ventilate the room immediately. Do not touch or bring your face close to the broken pieces.**

Failure to observe this will cause the user to absorb the gas which was released when the lamp broke and which contains nearly the same amount of mercury as fluorescent lamps, and the broken pieces will cause injury.

- If you believe that you have absorbed the gas or that the gas has got into your eyes or mouth, seek medical advice immediately.
- Ask your dealer about replacing the lamp unit and check the inside of the projector.

**When not using the projector for an extended period of time, remove the batteries from the remote control.**

Failure to observe this will cause the batteries to leak, overheat, catch fire or explode, which may result in fire or contamination of surrounding area.

### **■ MAINTENANCE**

**Ask your dealer about cleaning inside the projector once a year.**

Continuous use while dust is accumulated inside the projector may result in fire.

- For cleaning fee, ask your dealer.

■ **Trademarks**

- Windows, Windows Vista and Internet Explorer are registered trademarks or trademarks of Microsoft Corporation in the United States and other countries.
- Mac, macOS, OS X, and Safari are trademarks of Apple Inc., registered in the United States and other countries.
- The terms HDMI and HDMI High-Definition Multimedia Interface, and the HDMI Logo are trademarks or registered trademarks of HDMI Licensing Administrator, Inc. in the United States and other countries.
- PJLink™ is a trademark or pending trademark in Japan, the United States, and other countries and regions.
- Crestron Connected, the Crestron Connected logo, Crestron Fusion, Crestron RoomView, and RoomView are either trademarks or registered trademarks of Crestron Electronics, Inc. in the United States and/or other countries.
- Adobe, Acrobat, Flash Player, and Reader are either registered trademarks or trademarks of Adobe Systems Incorporated in the United States and/or other countries.
- Some of the fonts used in the on-screen menu are Ricoh bitmap fonts, which are manufactured and sold by Ricoh Company, Ltd.
- Other names, company names or product names used in these operating instructions are the trademarks or registered trademarks of their respective holders.  
Please note that the operating instructions do not include the ® and ™ symbols.

■ **Software information regarding this product**

This product incorporates the following software:

- (1) the software developed independently by or for Panasonic Connect Co., Ltd.,
- (2) the software owned by third party and licensed to Panasonic Connect Co., Ltd.,
- (3) the software licensed under the GNU General Public License, Version 2.0 (GPL V2.0),
- (4) the software licensed under the GNU LESSER General Public License, Version 2.1 (LGPL V2.1), and/or
- (5) open source software other than the software licensed under the GPL V2.0 and/or LGPL V2.1.

The software categorized as (3) - (5) are distributed in the hope that it will be useful, but WITHOUT ANY WARRANTY, without even the implied warranty of MERCHANTABILITY or FITNESS FOR A PARTICULAR PURPOSE. Please refer to the detailed terms and conditions thereof shown in the attached CD-ROM.

At least three (3) years from delivery of this product, Panasonic Connect Co., Ltd. will give to any third party who contacts us at the contact information provided below, for a charge no more than our cost of physically performing source code distribution, a complete machine-readable copy of the corresponding source code covered under GPL V2.0, LGPL V2.1 or the other licenses with the obligation to do so, as well as the respective copyright notice thereof.

Contact Information: [oss-cd-request@gg.jp.panasonic.com](mailto:oss-cd-request@gg.jp.panasonic.com)

■ **Illustrations in these operating instructions**

- Note that illustrations of the projector and screens may differ from the ones you actually see.

■ **Page references**

- Reference pages in this manual are indicated as: (➡ page 00).

■ **Term**

- In this manual, the “Wireless remote control unit” accessory is referred to as the “Remote control”.

---

## Features of the Projector

---

### Excellent Basic Performance

---

- ▶ Unique optical system, lamp dimming system and the DAYLIGHT VIEW function allow you to project a good-quality image even in a bright room.
- ▶ It has many useful functions such as compact design for portability and multiple input interface etc..

### Easy Setup

---

- ▶ The 1.6x optical zoom and the lens shift allow more flexible setup of the projector.
- ▶ KEYSTONE, CORNER CORRECTION and CURVED CORRECTION functions allow you to correct the image distortion easily in various places.

### Easy Maintenance

---

- ▶ New lamp driving system and long life filter have greatly improved the recommended time to replace the lamp and filter, so you can reduce the maintenance cost.

[Reference]

- Lamp: 5 000 Hours ([LAMP POWER] is set to [NORMAL])  
7 000 Hours ([LAMP POWER] is set to [ECO])

- Filter: 7 000 Hours

\* This time is only the target for replacement and not the warranty time.

## Quick Steps

---

For details, see the corresponding pages.

1. **Set up your projector.**  
(⇒ page 29)



2. **Connect with external devices.**  
(⇒ page 33)



3. **Connect the power cord.**  
(⇒ page 37)



4. **Power on.**  
(⇒ page 38)



5. **Make initial settings.**  
(⇒ page 38)

- Take this step when you power on for the first time after purchasing the projector.



6. **Select the input signal.**  
(⇒ page 41)



7. **Adjust the image.**  
(⇒ page 41)

# Chapter 1 Preparation

---

This chapter describes things you need to know or check before using the projector.



# Precautions for use

## Cautions when transporting

- When transporting the projector, hold it securely by its bottom and avoid excessive vibration and impacts. Doing so may damage the internal parts and result in malfunctions.
- Do not transport the projector with the adjustable feet extended. Doing so may damage the adjustable feet.

## Cautions when installing

### ■ Do not set up the projector outdoors.

- The projector is designed for indoor use only.

### ■ Do not use under the following conditions.

- Places where vibration and impacts occur such as in a car or vehicle: Doing so may damage the internal parts and result in malfunctions.
- Locations near the sea or areas affected by corrosive gas: Corrosion may damage internal components or cause the projector to malfunction.
- Near the exhaust of an air conditioner: Depending on the conditions of use, the screen may fluctuate in rare cases due to the heated air from the air exhaust port or the hot or cooled air. Make sure that the exhaust from the projector or other equipment, or the air from the air conditioner does not blow toward the front of the projector.
- Places with sharp temperature fluctuations such as near lights (studio lamps): Doing so may shorten the life of the lamp, or result in deformation of the outer case due to heat, which may cause malfunctions.

The operating environment temperature of the projector should be between 0 °C (32 °F) and 40 °C (104 °F) when using it at elevations lower than 1 200 m (3 937') above sea level<sup>\*1</sup>, and between 0 °C (32 °F) and 30 °C (86 °F) when using it at high altitudes (between 1 200 m (3 937') and 2 700 m (8 858') above sea level).

\*1 When the operating environment temperature of the projector is between 35 °C (95°F) and 40 °C (104 °F), the lamp mode will change to [ECO] automatically.

- Near high-voltage power lines or near motors: Doing so may interfere with the operation of the projector.

### ■ Be sure to ask a specialized technician when installing the product to a ceiling.

This requires an optional ceiling mount bracket. Be sure to use the Projector Mount Bracket together with the ceiling mount bracket for high ceilings or low ceilings.

Model No.:

- ① ET-PKL100H (for high ceilings), ET-PKV400B (Projector Mount Bracket)
- ② ET-PKL100S (for low ceilings), ET-PKV400B (Projector Mount Bracket)

### ■ Focus adjustment

The projection lens is thermally affected by the light from the light source, making the focus unstable in the period just after switching on the power. It is recommended that the images are projected continuously for at least 30 minutes before the focus is adjusted.

### ■ Do not install the projector at elevations of 2 700 m (8 858') or higher above sea level.

Failure to do so may shorten the life of the internal parts and result in malfunctions.

### ■ Do not tilt the projector or place it on its side.

Do not tilt the projector body more than approximately  $\pm 30$  degrees vertically or  $\pm 15$  degrees horizontally. Over tilting may result in shortening the life of the components.

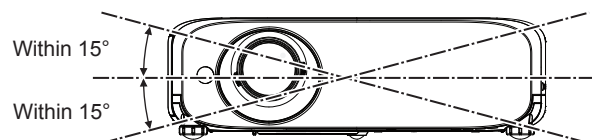
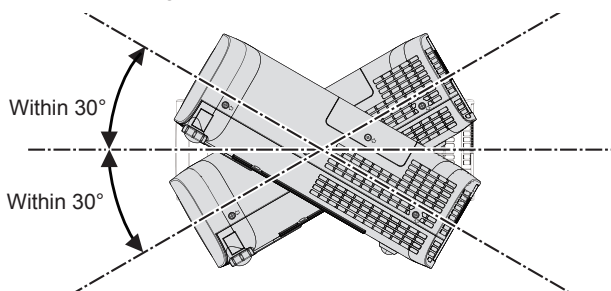

■ Cautions when setting the projectors

- Do not stack the projectors.
- Do not use the projector supporting it by the top.
- Do not block the ventilation ports (intake and exhaust) of the projector.
- Avoid heating and cooling air from the air conditioning system directly blow to the ventilation ports (intake and exhaust) of the projector.

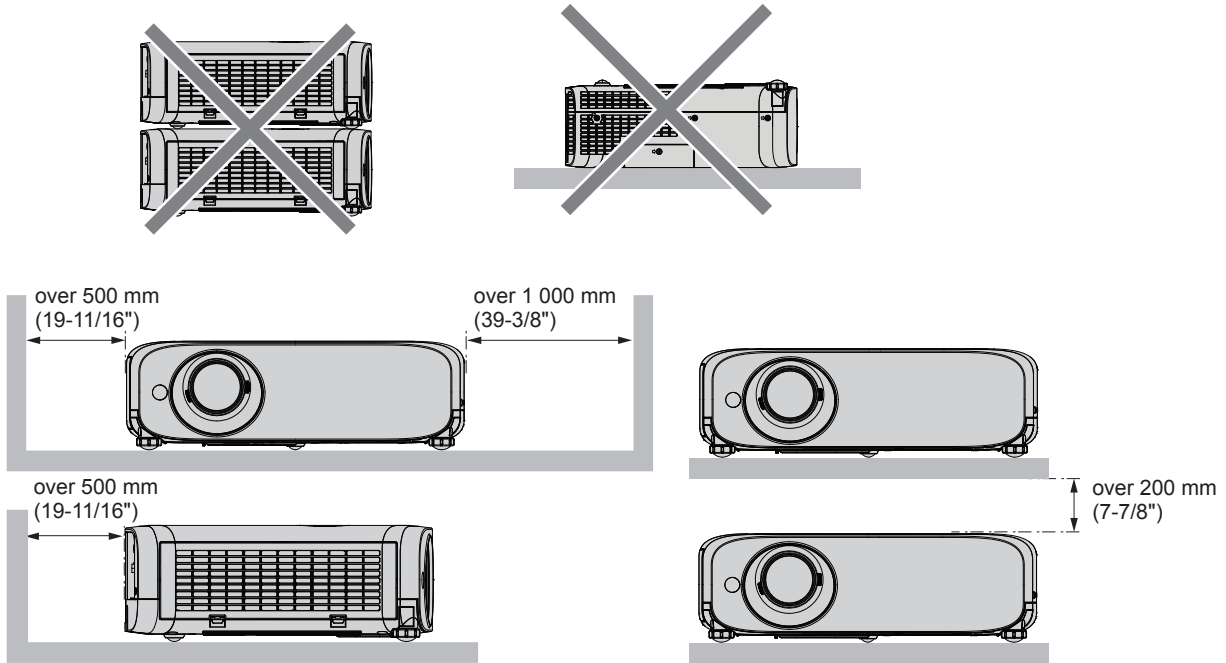

- Depending on where the projector is used, heated air from an exhaust port or warm or cold air from an air conditioner can cause a shimmering effect on screen.  
Avoid using in locations where exhaust or streams of air from projector, other devices and air conditioners flow between the projector and the screen.
- Do not install the projector in a confined space.  
When placing the projector in a confined space, a ventilation and/or air conditioning system is required. Exhaust heat may accumulate when the ventilation is not enough, triggering the protection circuit of the projector.

**Security**

Take safety measures against following incidents.

- Personal information being leaked via this product.
- Unauthorized operation of this product by a malicious third party.
- Interfering or stopping of this product by a malicious third party.

Security instruction (➡ pages 78, 93)

- Make your password as difficult to guess as possible.
- Change your password periodically.
- Panasonic Connect Co., Ltd. or its affiliate companies will never ask for your password directly. Do not tell your password in case you receive such an inquiry.
- The connecting network must be secured by firewall or others.
- Set a password for web control and restrict the users who can log in.

## Cautions on use

---

### ■ To get a good picture quality

- In order to view a beautiful image in higher contrast, prepare an appropriate environment. Draw curtains or blinds over windows and turn off any lights near the screen to prevent outside light or light from indoor lamps from shining onto the screen.

### ■ Do not touch the surface of the projector lens with your bare hands.

If the surface of the lens becomes dirty from fingerprints or anything else, this will be magnified and projected onto the screen. Attach the supplied lens cap to the projection lens when you do not use the projector.

### ■ LCD panel

The LCD panel is precision-made. Note that in rare cases, pixels of high precision could be missing or always lit. Note that such phenomena do not indicate malfunction. If still images are projected for a long time, a residual image may remain on the LCD panel. Note that the residual image may not disappear.

### ■ Optical parts

When the operating environment temperature is high or in environments where lots of dust, cigarette smoke, etc. is present, the replacement cycle of the LCD panel, deflection panel and other optical parts may be shorter even if used for less than one year. Consult your dealer for details.

### ■ Do not move the projector or subject it to vibration or impact while it is operating.

Doing so may shorten the life of the built-in motor.

### ■ Lamp

The light source of the projector is a high-pressure mercury lamp.

A high-pressure mercury lamp has the following characteristics.

- The luminance of the lamp will decrease by duration of usage.
- The lamp may burst with a loud sound or have its service life shortened because of shock, chipping, or degradation due to cumulative runtime.
- The lamp life varies greatly depending on individual differences and usage conditions. In particular, continuous use for 12 hours or more and frequent off/on switching of the power greatly deteriorate the lamp and affect the lamp life.
- In rare cases, the lamp burst shortly after the projection.
- The risk of bursting increases when the lamp is used beyond its replacement cycle. Make sure to replace the lamp unit consistently. ("When to replace the lamp unit" (➔ page 102), "Replacing the Lamp unit" (➔ page 102))
- If the lamp bursts, gas contained inside of the lamp is released in a form of smoke.
- It is recommended to store replacement lamps for contingency.

### ■ Computer and external device connections

When connecting a computer or an external device, read this manual carefully regarding the use of power cords and shielded cables as well.

## Storage

---

When storing the projector, keep it in a dry room.

## Disposal

---

To dispose of the product, ask your local authorities or dealer for correct methods of disposal.

The lamp contains mercury. When disposing of used lamp units, contact your local authorities or dealer for correct methods of disposal.

## Accessories

Make sure the following accessories are provided with your projector. Numbers enclosed < > show the number of accessories.

**Wireless remote control unit <1>**  
(N2QAYA000088)

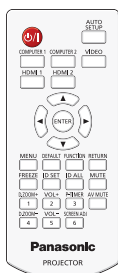

**CD-ROM <1>**  
(1JK1VZ470U)

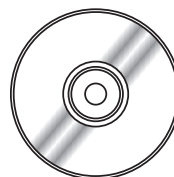

**Power cord**  
(TXFSX02UXRZ)

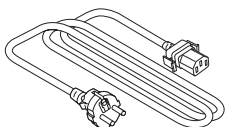

(TXFSX02UYAZ)

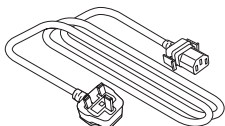

(TXFSX02UFEZ)

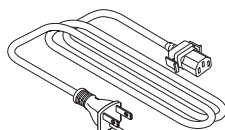

(TXFSX02UTRZ)

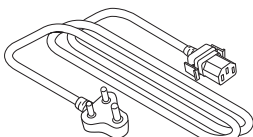

**RGB signal cable <1>**  
(K1HY15YY0012)

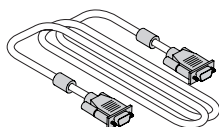

**AAA/R03 or AAA/LR03 battery <2>**  
(for remote control unit)

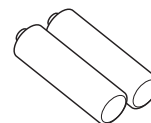

**String <1>**  
(for lens cap)  
(6103504711)



**Lens cap <1>**  
(Attached to the projector at the time of purchase)  
(TKKL5573)



### Attention

- After unpacking the projector, discard the power cord cap and packaging material properly.
- Do not use the supplied power cord for devices other than this projector.
- For lost accessories, consult your dealer.
- Store small parts in an appropriate manner, and keep them away from young children.

### Note

- The type and number of the power cord depend on the country in which you purchased the product.
- The model numbers of accessories are subject to change without prior notice.

## Contents of the supplied CD-ROM

The contents of the supplied CD-ROM are as follow.

<b>Instruction / list (PDF)</b>	Operating Instructions	
	Operating Instructions – Multi Monitoring & Control Software	
	Operating Instructions – Logo Transfer Software	
	List of Compatible Device Models	This is a list of projectors that are compatible with the software contained in the CD-ROM and their restrictions.
	Software license	The open source software licenses that used in this projector are included in the PDF files.
<b>Software</b>	Multi Monitoring & Control Software (Windows)	This software allows you to monitor and control multiple displays (projector or flat panel display) connected to the LAN.
	Logo Transfer Software (Windows)	This software allows you to transfer original images, such as company logos to be displayed when projection starts, to the projector.

### Note

- The “List of Compatible Device Models” for the flat panel display compatible with the “Multi Monitoring & Control Software” can be downloaded from the website (<https://panasonic.net/cns/prodisplays/>).

## Optional accessories

Options	Model No.
Ceiling Mount Bracket	ET-PKL100H (for high ceilings) ET-PKL100S (for low ceilings) ET-PKV400B (Projector Mount Bracket)
Replacement Lamp Unit	ET-LAV400
Replacement Filter Unit	ET-RFV400
D-SUB - S Video conversion cable	ET-ADSV

### Note

- The model numbers of optional accessories are subject to change without prior notice.

# About your projector

## Remote control

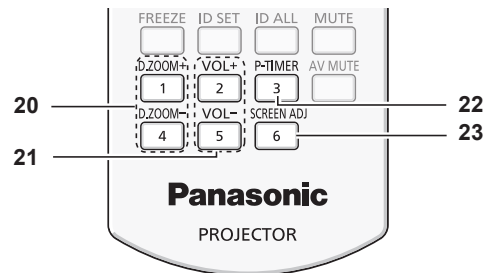
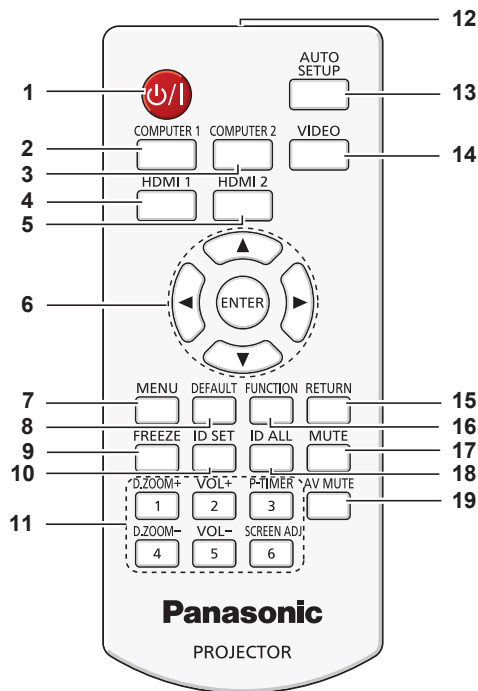

- 1 **Power <⏻/▶> button (⏻ standby/▶ power on)**  
Sets the projector to the state where the projector is switched off (standby mode). Also starts projection when the power is switched off (standby mode).
- 2 **<COMPUTER 1> button**  
Switches the COMPUTER1 signal to project.
- 3 **<COMPUTER 2> button**  
Switches the COMPUTER2 signal to project.
- 4 **<HDMI 1> button**  
Switches the HDMI1 signal to project.
- 5 **<HDMI 2> button**  
Switches the HDMI2 signal to project.
- 6 **<ENTER> button/▲▼◀▶ buttons**  
Navigate the menu display.
- 7 **<MENU> button**  
Displays or hides the main menu. (➡ page 48)
- 8 **<DEFAULT> button**  
Resets the content of the sub-menu to the factory default. (➡ page 49)
- 9 **<FREEZE> button**  
Pauses the projected image and mute the audio temporarily. (➡ page 44)
- 10 **<ID SET> button**  
Sets the ID number of the remote control to use for a system using multiple projectors. (➡ page 45)
- 11 **Number buttons**  
Act as number buttons. Use these buttons when setting the remote control codes or entering the password.
- 12 **Remote control signal transmitter**
- 13 **<AUTO SETUP> button**  
Automatically adjusts the image display position while projecting the image. (➡ page 42)
- 14 **<VIDEO> button**  
Switches the VIDEO signal to project.
- 15 **<RETURN> button**  
Return to the previous menu or cancel the setting.
- 16 **<FUNCTION> button**  
Assigns a frequently used operation as a shortcut button. (➡ page 43)
- 17 **<MUTE> button**  
Used to mute the audio. (➡ page 45)
- 18 **<ID ALL> button**  
Used to simultaneously control all the projectors with one remote control for a system using multiple projectors. (➡ page 45)
- 19 **<AV MUTE> button**  
Used to turn off the audio and video temporarily. (➡ page 45)
- 20 **<D.ZOOM +/-> buttons**  
Zoom in and out the images. (➡ page 44)
- 21 **<VOL +/-> buttons**  
Adjusts the volume of the built-in speaker or audio output.
- 22 **<P-TIMER> button**  
Operate the P-TIMER function. (➡ page 45)
- 23 **<SCREEN ADJ> button**  
You can correct various types of distortion in a projected image. (➡ page 42)

**Attention**

- Do not drop the remote control.
- Avoid contact with liquids.
- Do not attempt to modify or disassemble the remote control.
- Please observe the following contents that are described on the back of the remote control unit (see the right picture).
  1. Do not use a new battery together with an old battery.
  2. Do not use unspecified batteries.
  3. Make sure the polarities (+ and -) are correct when inserting the batteries.
- In addition, please read the contents that are related to batteries in the “Read this first!”.

CAUTION	
1. Do not use old battery with new one.	
2. Do not use batteries other than the type specified.	
3. Be sure the batteries are inserted properly.	

**Note**

- The remote control can be used within a distance of about 7 m (22'11-5/8") if pointed directly at the remote control signal receiver. The remote control can control at angles of up to  $\pm 30^\circ$  vertically and  $\pm 30^\circ$  horizontally, but the effective control range may be reduced.
- If there are any obstacles between the remote control and the remote control signal receiver, the remote control may not operate correctly.
- You can operate the projector by reflecting the remote control signal on the screen. The operating range may differ due to the loss of light caused by the properties of the screen.
- When the remote control signal receiver is lit with a fluorescent light or other strong light source, the projector may become inoperative. Set the projector as far from the luminous source as possible.

**Projector body**

■ Front

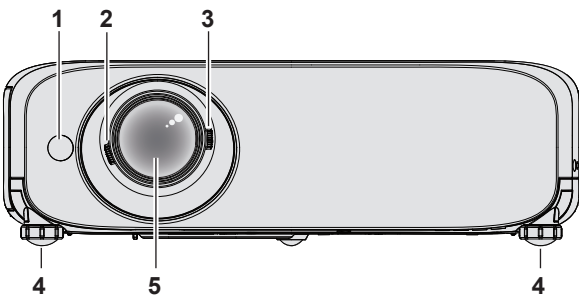

■ Side

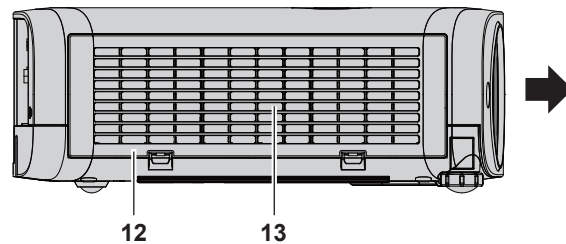

■ Rear

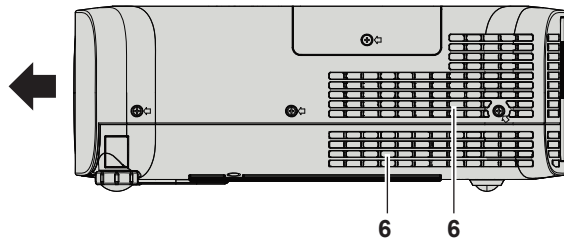
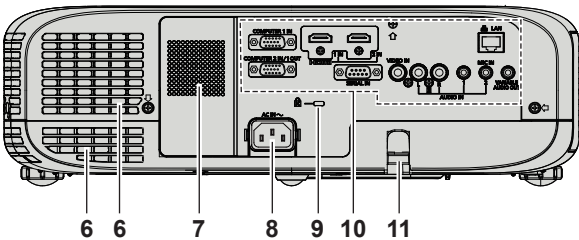

← Projection direction

**WARNING**

**Keep your hands and other objects away from the air exhaust port.**

- Keep your hands and face away.
- Do not insert your fingers.
- Keep heat-sensitive objects away.

Heated air from the air exhaust port can cause burns, injury, or deformations.

- 1 Remote control signal receiver**
- 2 Focus Lever**  
Adjusts the focus.
- 3 Zoom Lever**  
Adjusts the zoom.
- 4 Adjustable feet**  
Adjusts the projection angle.
- 5 Projection Lens**
- 6 Air exhaust port**
- 7 Speaker**

- 8 <AC IN> terminal**  
Connects the supplied power cord.
- 9 Security slot**  
This security slot is compatible with the Kensington security cables.
- 10 Connecting terminals (→ page 25)**
- 11 Burglar hook port**  
Attaches a burglar prevention cable, etc.
- 12 Air filter cover**  
The air filter unit is inside.
- 13 Air intake port**

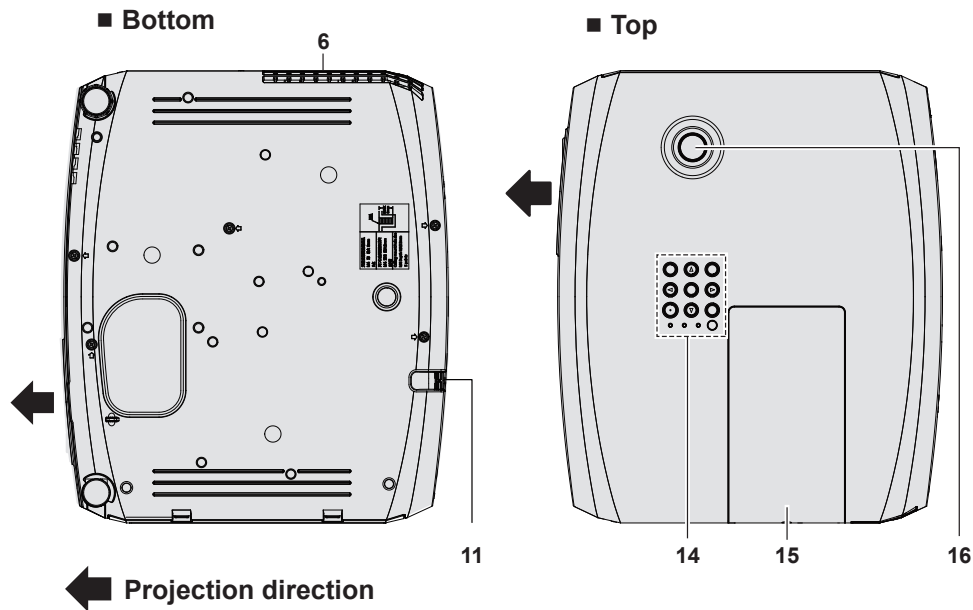

14 Control panel and Indicators

15 Lamp cover  
The lamp unit is inside.

16 Vertical lens shift dial  
Adjusts the vertical position of the projected image.

**Attention**

- Do not block the ventilation ports (intake and exhaust) of the projector.

■ Control panel and Indicators

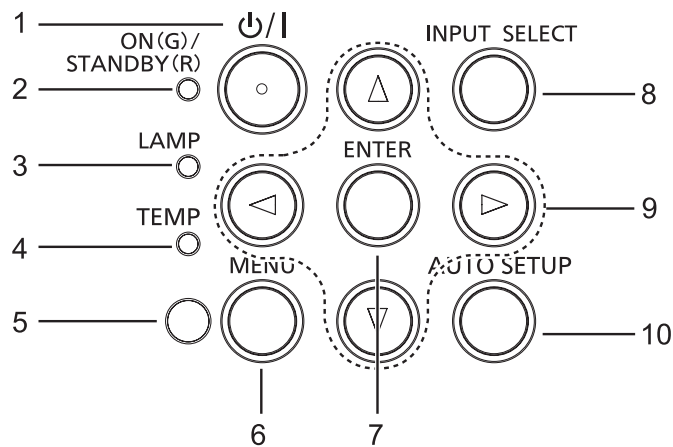

- 1 **Power <⏻/⏻> button (⏻ standby/⏻ power on)**  
Sets the projector to the state where the projector is switched off (standby mode). Also starts projection when the power is switched off (standby mode).
- 2 **Power indicator <ON(G)/STANDBY(R)>**  
Displays the status of the power.
- 3 **Lamp indicator <LAMP>**  
Displays the status of the lamp.
- 4 **Temperature indicator <TEMP>**  
Displays the status of the internal temperature.
- 5 **Ambient Luminance sensor**  
Detects room's light and select proper image quality.

- 6 **<MENU> button**  
Displays or hides the main menu. (➡ page 48)
- 7 **<ENTER> button**  
Determines and executes an item in the menu screen.
- 8 **<INPUT SELECT> button**  
Switches the input signal to project. (➡ page 43)
- 9 **▲▼◀▶ buttons**  
Navigates the menu screen.  
Adjusts the volume level (◀▶).
- 10 **<AUTO SETUP> button**  
Automatically adjusts the image display position while projecting the image. (➡ page 42)



■ Connecting terminals

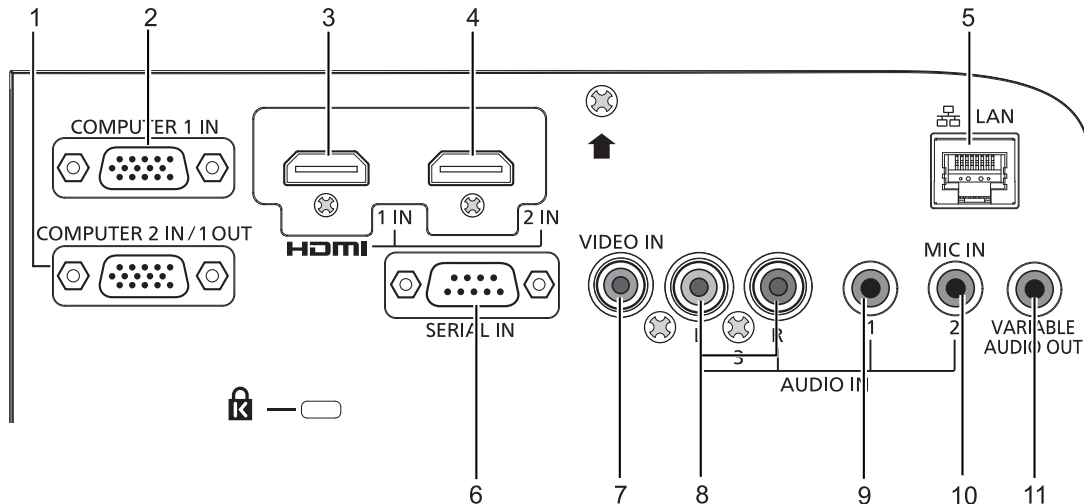

**1 <COMPUTER 2 IN/1 OUT> terminal**

This is the terminal to input RGB signals or  $Y C_B C_R / Y P_B P_R$  signals.

Or output the RGB signals or  $Y C_B C_R / Y P_B P_R$  signals to an external device.

**2 <COMPUTER 1 IN> terminal**

This is the terminal to input RGB signals, Y/C signals or  $Y C_B C_R / Y P_B P_R$  signals.

**3 <HDMI 1 IN> terminal**

This is the terminal to input HDMI1 signals.

**4 <HDMI 2 IN> terminal**

This is the terminal to input HDMI2 signals.

**5 <LAN> terminal**

This is the LAN terminal to connect to the network.

**6 <SERIAL IN> terminal**

This is the RS-232C compatible terminal to externally control the projector by connecting a computer.

**7 <VIDEO IN> terminal**

This is the terminal to input video signals.

**8 <AUDIO IN 3 (L/R)> terminal**

This is the terminal to input audio signals. Left input <L> and right input <R> are provided for the <AUDIO IN 3> terminal.

**9 <AUDIO IN 1> terminal**

This is the terminal to input audio signals.

**10 <AUDIO IN 2 (MIC IN)> terminal**

This is the terminal to input audio signals. Or connect the MIC to this terminal.

**11 <VARIABLE AUDIO OUT> terminal**

This is the terminal to output the input audio signal to the projector.

**Attention**

- When a LAN cable is directly connected to the projector, the network connection must be made indoors.

# Preparing the remote control

## Inserting and removing batteries

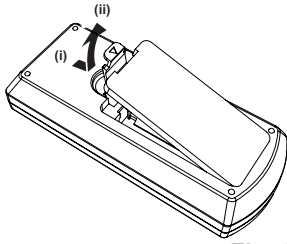

Fig. 1

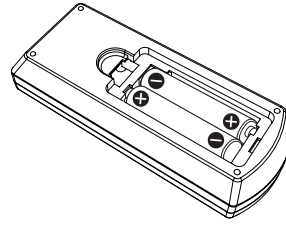

Fig. 2

- 1) **Open the cover. (Fig. 1)**
- 2) **Insert batteries and close the cover (insert the "⊖" side first). (Fig. 2)**
  - When removing the batteries, perform the steps in reverse order.

## When using the system with multiple projectors

When you use the system with multiple projectors, you can operate all the projectors simultaneously or each projector individually by using single remote control, if a unique ID number is assigned to each projector.

When you want to set the ID number, at first you need to complete the Initial setting, and then after setting the ID number of the projector, set the ID number on the remote control. About Initial setting, please refer to "When the initial setting screen is displayed" (➔ page 38).

The factory default ID number of the unit (the projector and the remote control) is set to [ALL], you can control with this setting. If necessary, please set the ID number to the remote control and the projector. About how to set the ID number of the remote control, please refer to "Setting the ID number of the remote control" (➔ page 45).

### Note

- Set the ID number of the projector from the [PROJECTOR SETUP] menu → [PROJECTOR ID] (➔ page 72).

## Attaching the lens cap

When moving this projector or while not using it over an extended period of time, attach the lens cap.

To prevent loss for the lens cap, please according to the following procedures, attach the lens cap with the string of accessories.

- 1) Thread the thinner end of the string through the hole on the lens cap.

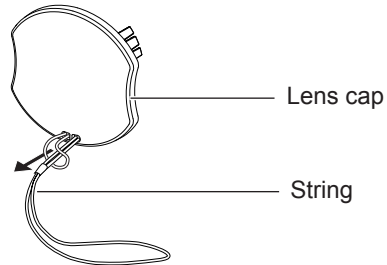

- 2) Thread the other end of the string through the hole on the bottom of the projector.

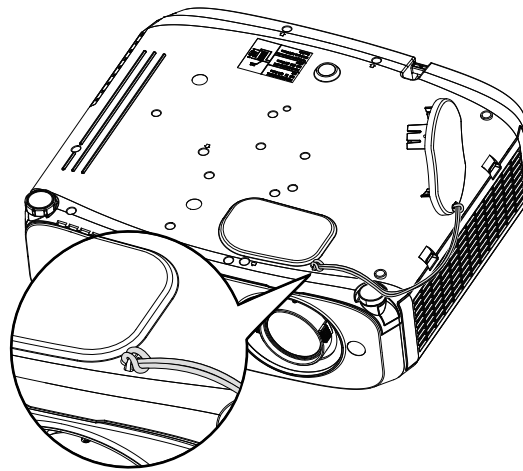

# Chapter 2 Getting Started

---

This chapter describes things you need to do before using the projector such as the setup and connections.

# Setting up

## Installation mode

There are four ways to set up the projector. Set the [PROJECTOR SETUP] menu → [PROJECTION METHOD] (➔ page 72) depending on the installation mode.

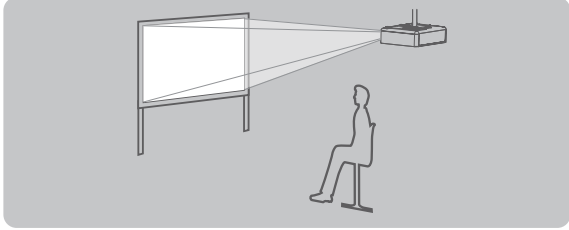
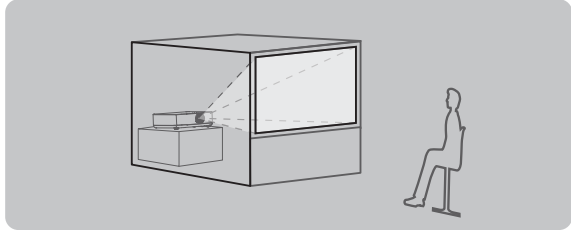
Mounting on the ceiling and projecting forward		Setting on a desk/floor and projecting from rear (Using the translucent screen)	
			
Menu item	Method	Menu item	Method
[PROJECTION METHOD]	[FRONT/CEILING]	[PROJECTION METHOD]	[REAR/DESK]

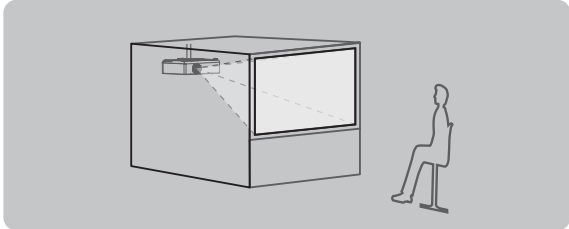
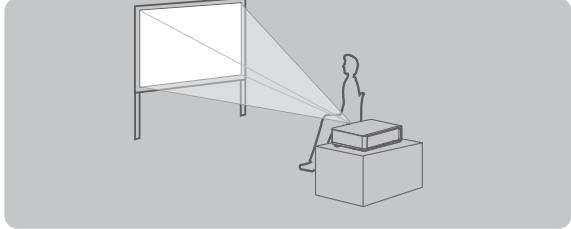
Mounting on the ceiling and projecting from rear (Using the translucent screen)		Setting on a desk/floor and projecting forward	
			
Menu item	Method	Menu item	Method
[PROJECTION METHOD]	[REAR/CEILING]	[PROJECTION METHOD]	[FRONT/DESK]

## Parts for ceiling mount (optional)

This requires an optional ceiling mount bracket. Be sure to use the Projector Mount Bracket together with the ceiling mount bracket for high ceilings or low ceilings.

Model No.:

- ① ET-PKL100H (for high ceilings), ET-PKV400B (Projector Mount Bracket)
- ② ET-PKL100S (for low ceilings), ET-PKV400B (Projector Mount Bracket)

- Use only the ceiling mount brackets specified for this projector.
- Refer to the Installation Instructions for the ceiling mount bracket when you install the bracket and the projector.

### Attention

- To ensure projector performance and security, installation of the ceiling mount bracket must be carried out by your dealer or a qualified technician.

## Screen size and throw distance

Refer to the screen size and projection distances to install the projector. Image size and image position can be adjusted in accordance with the screen size and screen position.

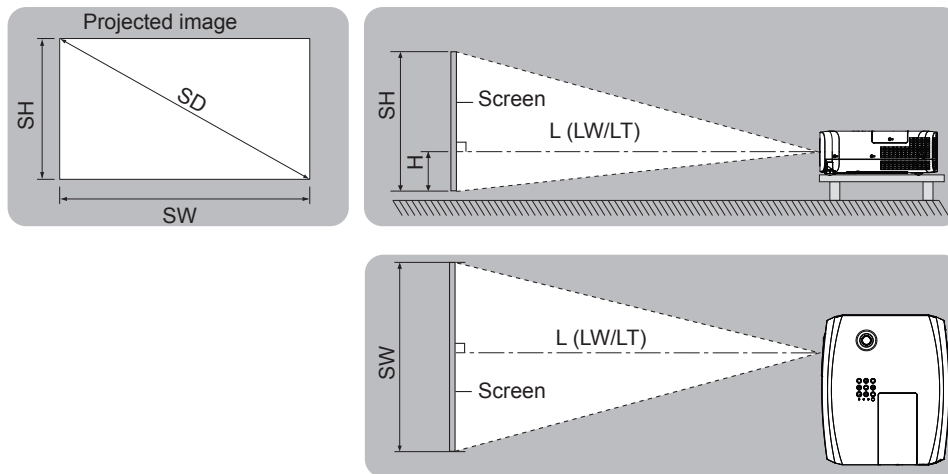

L (LW/LT) *1	Projection distance (m)
SH	Image height (m)
SW	Image width (m)
H	Distance from the center of lens to the image lower end (m)
SD	Projected image size (m)

\*1 LW : Minimum distance  
LT : Maximum distance

### Attention

- Before installing, please read "Precautions for Use". (➡ page 17)

### Projection distance

All measurements below are approximate and may differ slightly from the actual measurements. (Unit: m)

Projection size	4:3 aspect ratio			16:9 aspect ratio			16:10 aspect ratio		
	Screen diagonal (SD)	Minimum distance (LW)	Maximum distance (LT)	Height position (H)	Minimum distance (LW)	Maximum distance (LT)	Height position (H)	Minimum distance (LW)	Maximum distance (LT)
0.76 (30")	0.78	1.27	0.025 ~ 0.228	0.70	1.15	0.002 ~ 0.186	0.68	1.12	0.022 ~ 0.201
1.02 (40")	1.05	1.71	0.034 ~ 0.306	0.95	1.55	0.003 ~ 0.250	0.93	1.51	0.030 ~ 0.270
1.27 (50")	1.32	2.14	0.042 ~ 0.381	1.19	1.94	0.004 ~ 0.311	1.16	1.89	0.037 ~ 0.337
1.52 (60")	1.58	2.57	0.051 ~ 0.456	1.43	2.33	0.005 ~ 0.372	1.39	2.26	0.045 ~ 0.403
1.78 (70")	1.86	3.01	0.059 ~ 0.534	1.69	2.73	0.005 ~ 0.436	1.64	2.66	0.052 ~ 0.472
2.03 (80")	2.12	3.44	0.068 ~ 0.609	1.93	3.12	0.006 ~ 0.497	1.87	3.03	0.060 ~ 0.538
2.29 (90")	2.40	3.88	0.076 ~ 0.687	2.18	3.52	0.007 ~ 0.561	2.12	3.43	0.067 ~ 0.607
2.54 (100")	2.67	4.31	0.085 ~ 0.762	2.42	3.91	0.008 ~ 0.622	2.35	3.80	0.075 ~ 0.673
3.05 (120")	3.21	5.18	0.102 ~ 0.915	2.91	4.70	0.009 ~ 0.747	2.83	4.57	0.090 ~ 0.808
3.81 (150")	4.01	6.48	0.127 ~ 1.143	3.64	5.88	0.012 ~ 0.933	3.54	5.72	0.112 ~ 1.010
5.08 (200")	5.36	8.65	0.169 ~ 1.524	4.86	7.85	0.015 ~ 1.245	4.73	7.64	0.150 ~ 1.346
6.35 (250")	6.71	10.83	0.212 ~ 1.905	6.09	9.83	0.019 ~ 1.556	5.92	9.56	0.187 ~ 1.683
7.62 (300")	8.05	13.00	0.254 ~ 2.286	7.31	11.80	0.023 ~ 1.867	7.11	11.48	0.224 ~ 2.019

### Projection distance formulas

Any other projection distance can be obtained according to the screen dimensions (m) by using the following calculations. The calculated distance may contain a certain error.

If you want to calculate the projection distance with projected image size SD (unit: inch) by substituting, please assign 0.0254 times to the SD value.

	4:3 aspect ratio	16:9 aspect ratio	16:10 aspect ratio
Screen height (SH)	= $0.6 \times SD$	= $0.490 \times SD$	= $0.530 \times SD$
Screen width (SW)	= $0.8 \times SD$	= $0.872 \times SD$	= $0.848 \times SD$
Minimum distance (LW)	= $1.0609 \times SD - 0.0294$	= $0.9632 \times SD - 0.0294$	= $0.9371 \times SD - 0.0294$
Maximum distance (LT)	= $1.7098 \times SD - 0.0319$	= $1.5523 \times SD - 0.0319$	= $1.5103 \times SD - 0.0319$

### Adjusting adjustable feet

Lift the front of the projector and press the feet lock latches on both side of the projector.

Release the feet lock latches to lock the adjustable feet and rotate the adjustable feet to a proper height and tilt.

Extend the adjustable feet by rotating in the direction shown in the figure and retract by rotating in the opposite direction.

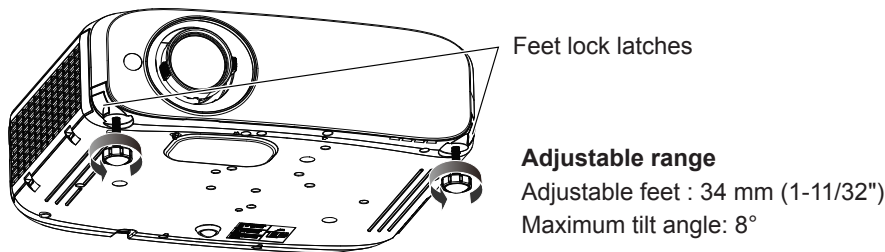

### Attention

- Heated air is expelled from the air exhaust port while the lamp is lit. Do not touch the air exhaust port directly when adjusting the adjustable feet.

### Adjusting the position using the vertical lens shift function

If the projector is not positioned right in front of the center of the screen, you can adjust the vertical position of projected image within the shift range of the lens.

When you rotate the vertical lens shift dial clockwise (counterclockwise), projected image will move upward (downward).

#### ■ Top view

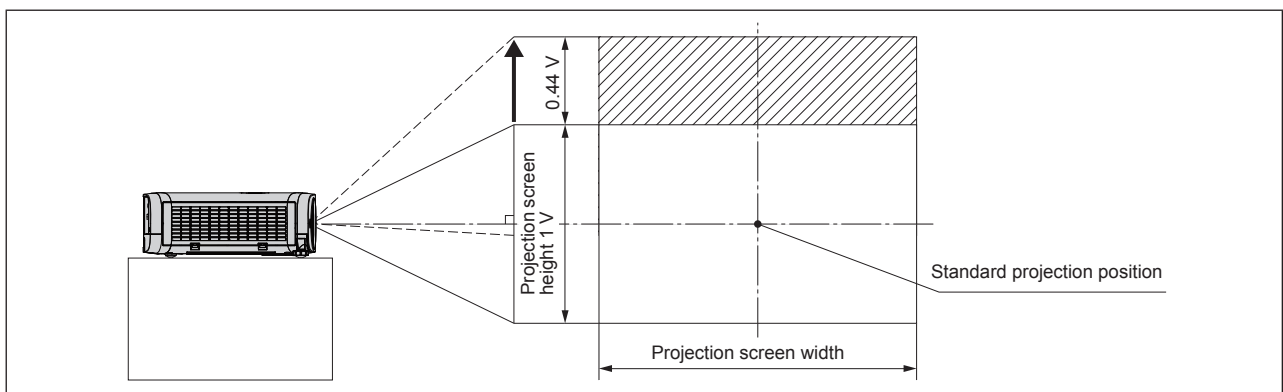
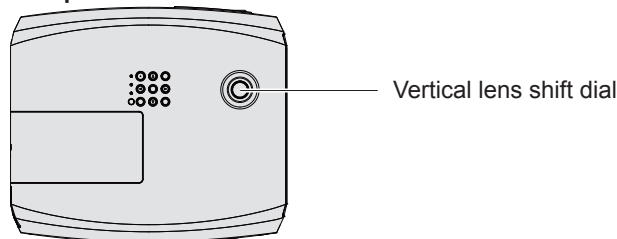

### Attention

---

- If various types of distortion occur on the projected image, perform [SCREEN ADJUSTMENT] from the [POSITION] menu. (➡ page 57)
- Please note the followings when using the projector.
  - Do not touch the lens while it is moving as this could cause injury to the fingers.
  - Never allow children to touch the lens.



# Connecting

## Before connecting

- Before connecting, carefully read the operating instructions for the external device to be connected.
- Turn off the power switch of the devices before connecting cables.
- Take note of the following points before connecting the cables. Failure to do so may result in malfunctions.
  - When connecting a cable to a device connected to the projector or the projector itself, touch any nearby metallic objects to eliminate static electricity from your body before performing work.
  - Do not use unnecessarily long cables to connect to a device connected to the projector or to the projector body. The longer the cable, the more it is susceptible to noise. Since using a cable while it is wound makes it act like an antenna, it is more susceptible to noise.
  - When connecting cables, connect GND first, then insert the connecting terminal of the connecting device in a straight manner.
- If any connection cable is not supplied with the device, or if no optional cable is available for connection of the device, prepare a necessary system connection cable to suit the device.
- Video signals containing too much jitter may cause the images on the screen to randomly wobble or wafture. In this case, a time base corrector (TBC) must be connected.
- The projector accepts VIDEO signals, Y/C signals,  $YC_B C_R / YP_B P_R$  signals and analog RGB signals (synchronous signals are TTL level), and digital signal.
- Some computer models or graphics cards are not compatible with the projector.
- When using long cables to connect with each of equipment to the projector, there is a possibility that the image will not be output correctly unless a compensator is used.
- For details on what video signals the projector supports, see “List of compatible signals”. (➔ page 112)

## <COMPUTER 1 IN> terminal pin assignments and signal names

Outside view	Pin No.	Signal names	Pin No.	Signal names
	①	R/P <sub>R</sub> /C	⑨	+ 5 V
	②	G/Y/Y	⑩	GND
	③	B/P <sub>B</sub>	⑪	GND
	④	—	⑫	DDC data
	⑤	GND	⑬	HD/SYNC
	⑥	GND	⑭	VD
	⑦	GND	⑮	DDC clock
	⑧	GND		

## <COMPUTER 2 IN/1 OUT> terminal pin assignments and signal names

Outside view	Pin No.	Signal names	Pin No.	Signal names
	①	R/P <sub>R</sub>	⑨	+ 5 V
	②	G/Y	⑩	GND
	③	B/P <sub>B</sub>	⑪	—
	④	—	⑫	DDC data
	⑤	GND	⑬	HD/SYNC
	⑥	GND	⑭	VD
	⑦	GND	⑮	DDC clock
	⑧	GND		

<HDMI 1 IN> terminal and <HDMI 2 IN> terminal pin assignments and signal names

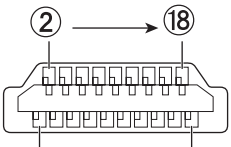
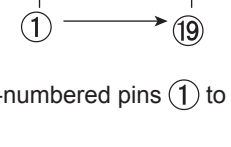
Outside view	Pin No.	Signal names	Pin No.	Signal names
Even-numbered pins ② to ⑱ 	①	T.M.D.S data 2+	⑪	T.M.D.S clock shield
	②	T.M.D.S data 2 shield	⑫	T.M.D.S clock -
	③	T.M.D.S data 2-	⑬	CEC
	④	T.M.D.S data 1+	⑭	—
	⑤	T.M.D.S data 1 shield	⑮	SCL
	⑥	T.M.D.S data 1-	⑯	SDA
	⑦	T.M.D.S data 0+	⑰	DDC/CEC GND
	⑧	T.M.D.S data 0 shield	⑱	+5V
	⑨	T.M.D.S data 0-		Hot plug detection
	⑩	T.M.D.S clock +		
Odd-numbered pins ① to ⑱ 				

Connecting example : AV equipment

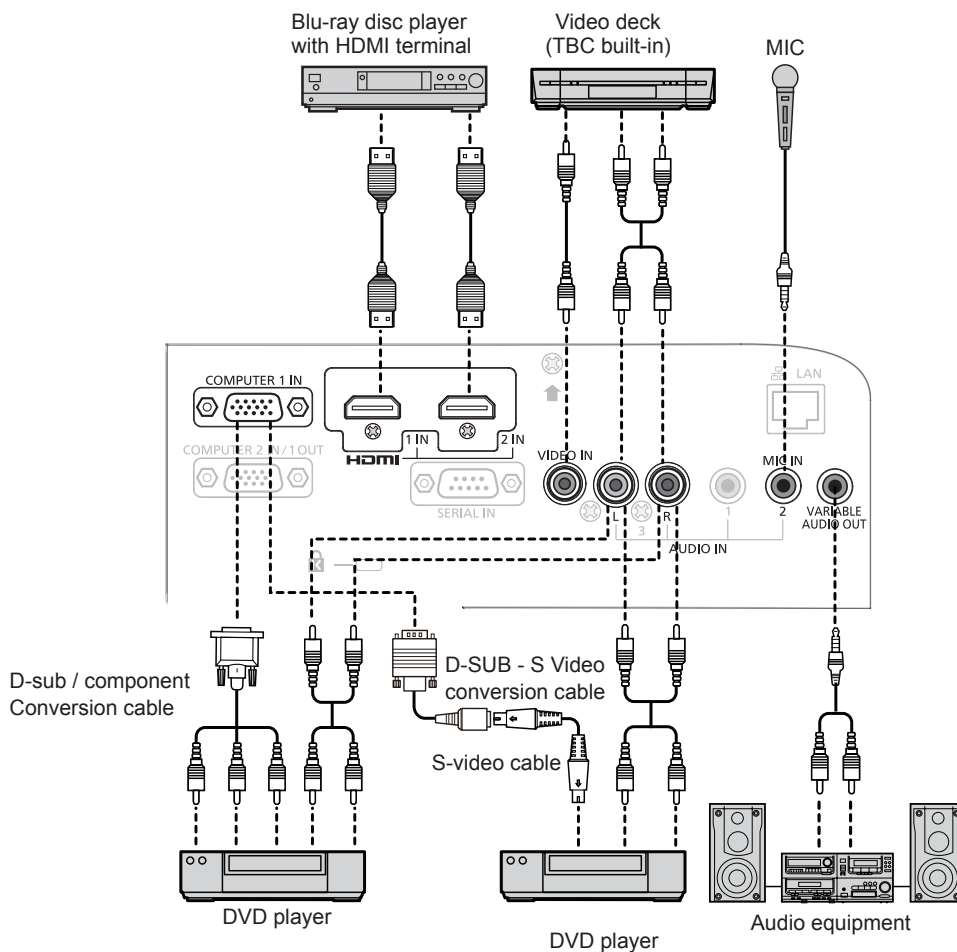

Attention

- Always use one of the following when connecting a VCR.
  - A VCR with built-in time base corrector (TBC).
  - A time base corrector (TBC) between the projector and the VCR.
- If nonstandard burst signals are connected, the image may be distorted. In such case, connect the time base corrector (TBC) between the projector and the external devices.

Note

- For an HDMI cable, use an HDMI High Speed cable that conforms to HDMI standards. If a cable that does not conform to HDMI standards is used, images may be interrupted or may not be displayed.
- This projector does not support the Viera link (HDMI).
- When input the Y/C signal to the <COMPUTER 1 IN> terminal, please prepare a necessary D-SUB - S Video conversion cable (ET-ADSV).
- If the [AUDIO IN SELECT] settings are incorrect, the projector may have malfunctions such as the absence of audio.
- When the <VARIABLE AUDIO OUT> terminal is connected with cable, the sound will not be output from the built-in speaker.

**Connecting example : Computers**

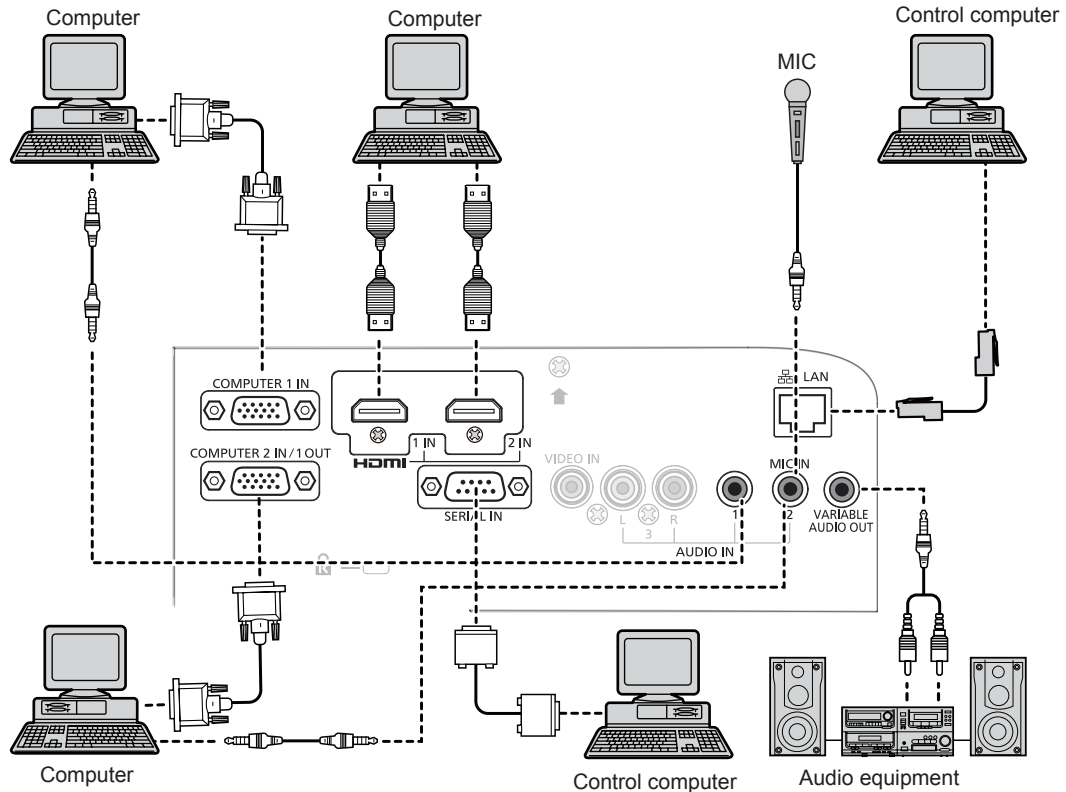

**Attention**

- When connecting the projector to a computer or an external device, use the power cord supplied with each device and commercially available shielded cables.

**Note**

- If you operate the projector using the computer with the resume feature (last memory), you may have to reset the resume feature to operate the projector.
- If the [AUDIO IN SELECT] settings are incorrect, the projector may have malfunctions such as the absence of audio. (➔ page 76)
- When the <VARIABLE AUDIO OUT> terminal is connected with cable, the sound will not be output from the built-in speaker.

# Chapter 3 Basic Operations

---

This chapter describes basic operations to start with.

# Powering on/off the projector

## Connecting the power cord

Make sure that the supplied power cord is securely fixed to the projector body to prevent it from being removed easily. For details of power cord handling, refer to “Read this first!”. (➔ page 4)

### Attaching

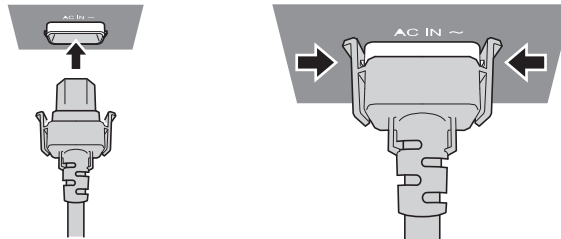

- 1) Check the shapes of the <AC IN> terminal on the back of the projector body and the power cord connector and insert the plug completely in the correct direction (until you hear the side tabs click in place).

### Removing

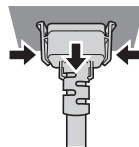

- 1) Confirm that the projector is in standby mode, and remove the power plug from the outlet.
- 2) Remove the power cord connector from the <AC IN> terminal of the projector body while pressing the side tabs.

## Power indicator

Displays the status of the power. Check the <ON(G)/STANDBY(R)> status of the power indicator before operating the projector.

Power indicator <ON(G)/STANDBY(R)>

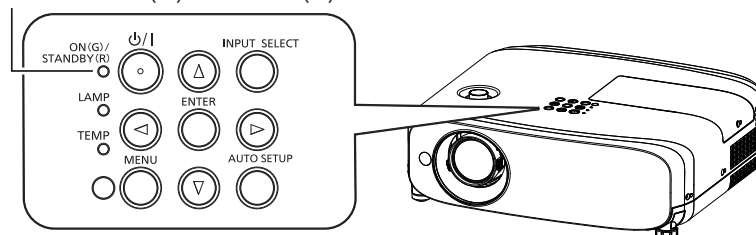

Indicator status		Status
	Off	The power cord is unplugged.
Red	Lighting	The power is switched off (in standby mode). The [ECO MANAGEMENT] ➔ [STANDBY MODE] is set to [ECO].
	Blinking <sup>*1</sup>	The power is switched off (in standby mode). The [ECO MANAGEMENT] ➔ [STANDBY MODE] is set to [NORMAL].
Orange	Lighting	The projector is cooling down. The power is switched off after a while. (Changes to the standby mode.)
Green	Lighting	Projecting.
	Blinking <sup>*2</sup>	The power is on and the lamp is not working. The [ECO MANAGEMENT] ➔ [POWER MANAGEMENT] is set to [READY].
	Blinking <sup>*3</sup>	The lamp starts work. The projector will project image after a while.

\*1 The indicator will light as the following order:  
2.75 seconds (light) → 0.25 seconds (off)

- \*2 The indicator will light as the following order:  
2.0 seconds (light) → 2.0 seconds (off)
- \*3 The indicator will light as the following order:  
0.5 seconds (light) → 0.5 seconds (off)

**Note**

- If the power indicator <ON(G)/STANDBY(R)> is blinking in red in a cycle of 2.75 seconds (light) → 0.25 seconds (off) → 0.75 seconds (light) → 0.25 seconds (off) → 0.75 seconds (light) → 0.25 seconds (off), please consult your dealer.

**Powering On the Projector**

Before switching on the projector, make sure all the other devices are correctly connected (➡ page 33) and remove the lens cap.

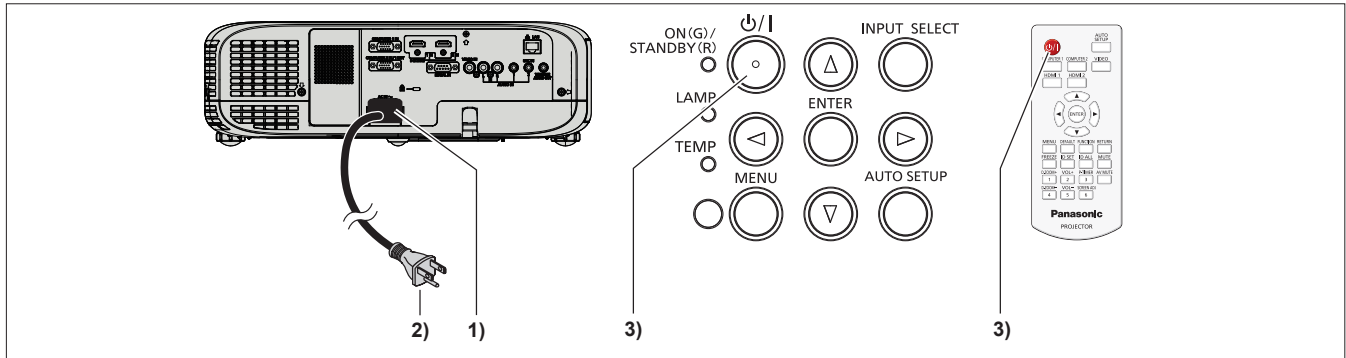

- 1) **Connect the power cord to the projector body.**
- 2) **Connect the power plug to an outlet.**
  - The power indicator <ON(G)/STANDBY(R)> lights or blinks, and the projector will enter the standby mode.
- 3) **Press the power button <ON(G)/STANDBY(R)> on the control panel or on the remote control.**
  - The power indicator <ON(G)/STANDBY(R)> lights in green and the image is soon projected on the screen.

**Attention**

- Be sure to remove the lens cap before starting projection.

**Note**

- If the [PROJECTOR SETUP] menu → [ECO MANAGEMENT] → [STANDBY MODE] is set to [ECO] (➡ page 74), it may take approx. 10 seconds longer before the projector starts projecting after the power is turned on, compared with when [NORMAL] is set.
- If the [PROJECTOR SETUP] menu → [ECO MANAGEMENT] → [STANDBY MODE] is set to [NORMAL], it may take approx. 1 minute to enable the network function after connecting the power cord.

**When the initial setting screen is displayed**

When the projector is switched on for the first time after purchase as well as when [INITIALIZE ALL] in the [PROJECTOR SETUP] menu is executed, the focus adjustment screen is displayed after projection starts, then the initial setting screen is displayed. Set them in accordance with circumstances.

In other occasions, you can change the settings by menu operations.

**Initial setting (display language)**

Select the language to show on the screen.

After completed the initial setting, you can change the display language from the [LANGUAGE] menu.

- 1) **Press ▲▼◀▶ to select the display language.**



- 2) **Press the <ENTER> button to proceed to the initial setting.**

**Initial setting (projector setup)**

Set each item.

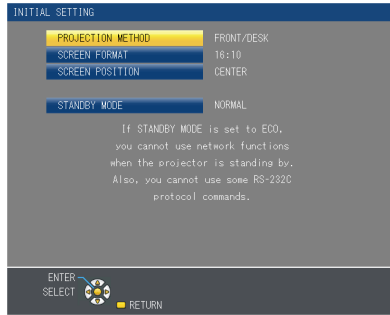

1) Press ▲▼ to select an item.

Item	Description	Page
[PROJECTION METHOD]	Set [PROJECTION METHOD] depending on the installation mode. After completed the initial setting, you can change the setting from the [PROJECTOR SETUP] menu → [PROJECTION METHOD].	72
[SCREEN FORMAT]	Set the screen format (aspect ratio) and display position of the image. After completed the initial setting, you can change the settings of each item from the [DISPLAY OPTION] menu → [SCREEN SETTING].	67
[SCREEN POSITION]	Set the display position of the image. After completed the initial setting, you can change the settings of each item from the [DISPLAY OPTION] menu → [SCREEN SETTING].	67
[STANDBY MODE]	Set the operation mode during standby. The default setting is [NORMAL], you can use the network function during standby. If you want to reduce the power consumption, it can be set to [ECO]. After completed the initial setting, you can change the setting from the [PROJECTOR SETUP] menu → [ECO MANAGEMENT] → [STANDBY MODE].	74

2) Press ◀▶ to switch the setting.

3) Press the <ENTER> button.

- Confirm the setting value and complete the initial setting.

**Note**

- If you press the <RETURN> button in the initial setting (projector setup) screen, you can go back to the initial setting (display language) screen.

**Making adjustments and selections**

It is recommended that images are projected continuously for at least 30 minutes before the focus is adjusted.

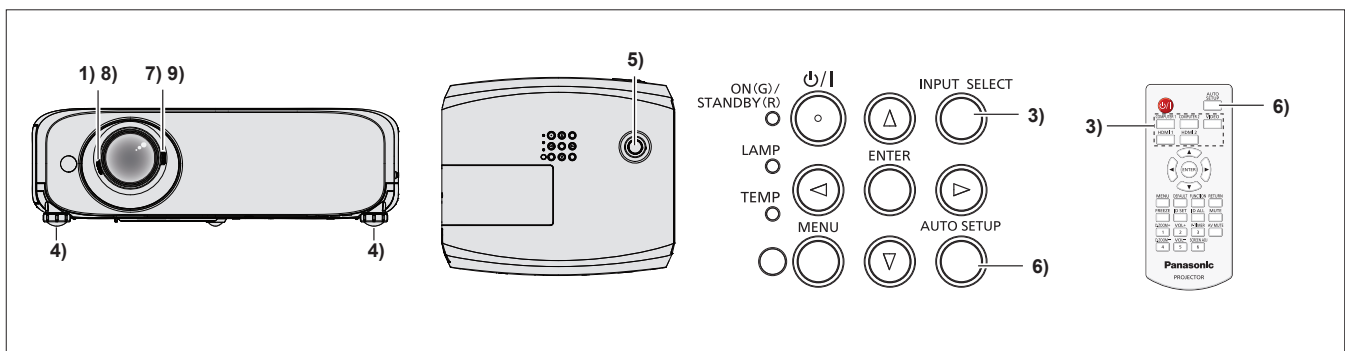

- 1) Rotate the focus lever to adjust the focus of the projected image roughly. (➡ page 41)
- 2) Change the settings of the [PROJECTOR SETUP] menu → [PROJECTION METHOD] depending on the installation mode. (➡ page 72)
  - Refer to “Navigating through the menu” (➡ page 48) for the operation of the menu screen.
- 3) Press the <INPUT SELECT> button on the control panel or the input selection (<COMPUTER 1>, <COMPUTER 2>, <VIDEO>, <HDMI 1> or <HDMI 2>) buttons to select the input signal.
- 4) Adjust the front, back and sideways tilt of the projector with the adjustable feet. (➡ page 31)

- 5) Move the vertical lens shift dial to adjust the position of the image.
- 6) If the input signal is an analog RGB signal, press the <AUTO SETUP> button on the control panel or the remote control.
- 7) Rotate the zoom lever to adjust the size of the image to match the screen.
- 8) Rotate the focus lever again to adjust the focus of the projected image.
- 9) Rotate the zoom lever again to adjust the zoom and the size of the image to match the screen.

#### Note

- When the projector is switched on for the first time after purchase as well as when the [PROJECTOR SETUP] menu → [INITIALIZE ALL] is executed, the initial setting screen is displayed after projection starts.

### Powering Off the Projector

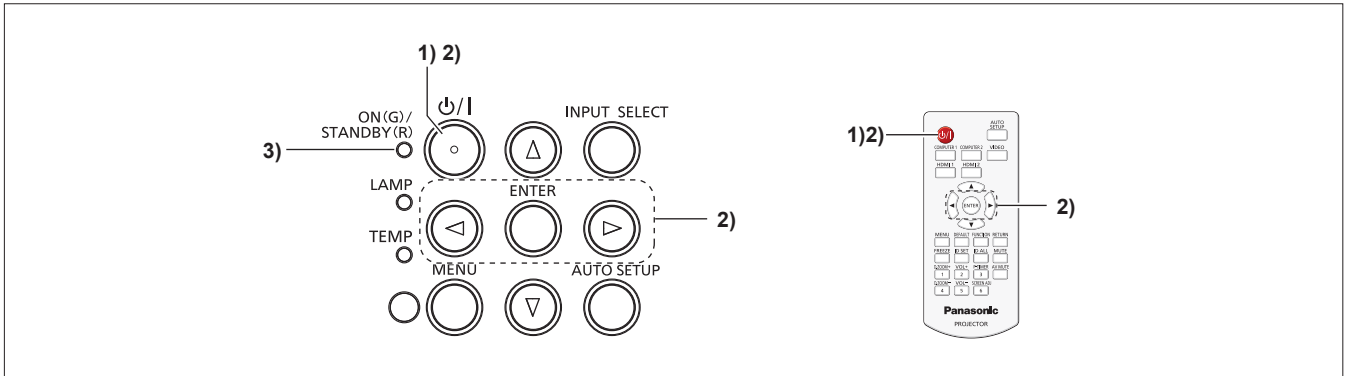

- 1) Press the power button <⏻/|> on the control panel or on the remote control.

- The following message appears.

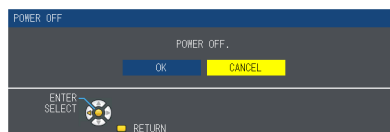

- 2) Press <◀▶> to select [OK], and press the <ENTER> button.  
(Or press the power button <⏻/|> on the control panel or on the remote control again.)

- Projection of the image will stop, and the power indicator <ON(G)/STANDBY(R)> lights in orange. (The fans keep running.)

- 3) Wait until the power indicator <ON(G)/STANDBY(R)> lights or blinks in red.

- The projector enters standby mode when the power indicator <ON(G)/STANDBY(R)> lights or blinks in red.

#### Note

- While the power indicator <ON(G)/STANDBY(R)> is lighting in orange, the lamp is being cooled down and the projector cannot be turned on. Wait until the power indicator <ON(G)/STANDBY(R)> starts lighting or blinking in red to turn on the projector again.
- When packing the projector for transportation and storage, please make sure that each indicator is off.

### Direct Power Off function

You can disconnect the power cord from the wall outlet or turn off the power breaker switch even during projection.

#### Attention

- Do not disconnect the power cord from the wall outlet or turn off the power breaker switch in a short time (about 1 minute) after the lamp is lit. Doing so may cause the lamp fail to light while you powering on the projector next time, or result in premature deterioration of the lamp.

#### Note

- When using the Direct Power Off function, you cannot restart the projector immediately after disconnecting the power cord from the wall outlet or turning off the power breaker switch. The lamp remains high temperature and needs to cool down, so it sometimes takes a longer time than usual for the lamp to light up again.



# Projecting

Check the connections of the peripheral devices (➔ page 33) and connection of the power cord (➔ page 37) and powering on the projector (➔ page 38) to start the projector. Select the image and adjust the state of the image.

## Selecting the input signal

Select an input signal.

- 1) Press <COMPUTER 1>, <COMPUTER 2>, <VIDEO>, <HDMI 1> or <HDMI 2> button on the remote control or <INPUT SELECT> button on the control panel.
  - The image of the signal being input in the selected terminal is projected.
  - You can check the input source through [DETAILED] / [SIMPLE] under the [DISPLAY OPTION] → [ON-SCREEN DISPLAY] → [INPUT GUIDE] menu.
  - You can also select the input source by pressing ◀▶ on the [DETAILED] screen.

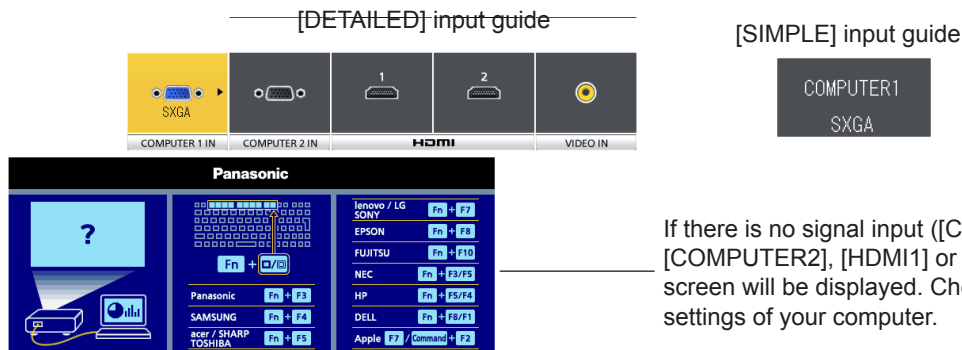

If there is no signal input ([COMPUTER1], [COMPUTER2], [HDMI1] or [HDMI2]), this screen will be displayed. Check the output settings of your computer.

## Attention

- Images may not be projected properly depending on the connected device and DVD, video tape, etc. to be played. Set the [PICTURE] menu → [RGB/YC<sub>B</sub>C<sub>R</sub>] or [RGB/YP<sub>B</sub>P<sub>R</sub>]. (➔ page 55)
- Check the aspect ratio of the screen and the image and select the optimum aspect ratio under the [POSITION] menu. (➔ page 57)

## How to adjust the state of the image

If the projected image or the position is not correct when the positioning of the projector and the screen is correctly installed, adjust the focus and zoom.

### 1) Adjust the projection angle.

- Install the projector on a flat surface and parallel to the screen so that the projected screen is rectangular.
- If the screen is tilted downward, extend the adjustable feet and adjust the projection screen so that the projected screen is rectangular.
- For details, see “Adjusting adjustable feet”. (➔ page 31)

### 2) Adjust the lens shift.

- Adjust the projection position with the vertical lens shift dial.
- For details, see “Adjusting the position using the vertical lens shift function”. (➔ page 31)

### 3) Adjust the zoom and the focus.

- Rotate the zoom lever to zoom in and out the image.
- Rotate the focus lever to adjust the focus of the projected image.



## Note

- It is recommended that the images are projected continuously for at least 30 minutes before the focus is adjusted.
- If you adjust the focus, you may need to adjust the size of the image by turning the zoom lever again.
- If various types of distortion occur, see the [POSITION] menu → [SCREEN ADJUSTMENT]. (➔ page 57)

# Basic operations by using the remote control

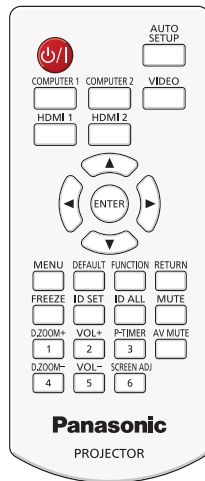

## Using the AUTO SETUP function

The automatic setup function can be used to automatically adjust the resolution, clock phase, and image position when analog RGB signals consisting of bitmap images such as computer signals are being input. Supplying images with bright white borders at the edges and high-contrast black and white characters is recommended when the system is in automatic adjustment mode.

Avoid supplying images that include halftones or gradation, such as photographs and computer graphics.



### 1) Press the <AUTO SETUP> button on the remote control.

- You can also press the <AUTO SETUP> button on the control panel.

### Note

- The [CLOCK PHASE] may shift even if it has completed without any incident. In such cases, adjust the [POSITION] menu → [CLOCK PHASE]. (➔ page 61)
- Automatic adjustment may not work depending on the model of the computer and the input signal. And, it may not work properly when the input signal is a blurred-edge image or a dark image.
- Images may be disrupted for a few seconds during automatic adjustment, but it is not a malfunction.
- If you press any button on the remote control during the automatic adjustment, the automatic adjustment will be canceled.
- If the automatic setup function is used while moving images are being input, the adjustment may not be performed properly even for an RGB signal that can use automatic setup.

## Using the SCREEN ADJ button

You can correct the trapezoidal distortion and the curved distortion of the projected image.



- Press the <SCREEN ADJ> button to select [KEYSTONE] individual adjustment screen.  
Or press the <SCREEN ADJ> button again to select [CORNER CORRECTION] individual adjustment screen.  
Or press the <SCREEN ADJ> button again to select [CURVED CORRECTION] individual adjustment screen.

- If the value is not adjusted after the individual adjustment screen is display, you can switch the individual adjustment screen by pressing the <SCREEN ADJ> button.

### 2) Press ▲▼◀▶ to adjust the value.

- After adjusting the value, press the <SCREEN ADJ> button, you cannot switch to the other individual adjustment screen.

### Note

- For more details, refer to the [POSITION] menu → [SCREEN ADJUSTMENT]. (➔ page 57)

## Controlling the volume of the speaker

You can control the volume of the projector's speaker or audio output.

VOL+



VOL-



buttons

### 1) Press the <VOL +> button / <VOL -> button on the remote control.

- You can also press ◀▶ on the control panel.

<VOL +>	Increases the volume.
<VOL ->	Decreases the volume.

## Using the FUNCTION button

Some operations in the menu can be assigned to the <FUNCTION> button on the remote control so that it can be used as an easy shortcut button.

FUNCTION



button

### 1) Press the <FUNCTION> button on the remote control.

## To assign functions to the <FUNCTION> button

### 1) Press the <MENU> button on the control panel or the remote control to display the menu items (main menu, sub menu, or details menu) you want to assign.

- Refer to “Navigating through the menu” (➔ page 48) for the operation of the on-screen menu.

### 2) Press and hold the <FUNCTION> button for 3 seconds or more.

#### Note

- After settings have been completed, the assigned menu item (main menu, sub-menu, or details menu) will be displayed in [ASSIGNED FUNCTION] of the operation guide under the menu.
- Perform the [PROJECTOR SETUP] menu → [FUNCTION BUTTON] (➔ page 74) when deallocating functions.

## Switching the input signal

You can switch the input signals to project.

COMPUTER 1



COMPUTER 2



VIDEO



HDMI 1



HDMI 2



buttons

### 1) Press <COMPUTER 1>, <COMPUTER 2>, <VIDEO>, <HDMI 1> or <HDMI 2> button on the remote control.

- You can also press the <INPUT SELECT> button on the control panel.

<COMPUTER 1>	Switch to COMPUTER1 input.
<COMPUTER 2>*1	Switch to COMPUTER2 input.
<VIDEO>	Switch to VIDEO input.
<HDMI 1>	Switch to HDMI1 input.
<HDMI 2>	Switch to HDMI2 input.

\*1 When [COMPUTER2 SELECT] is set to [COMPUTER1 OUT], if you press the <COMPUTER 2> button on the remote control, the input signal cannot be changed and the message “KEY NOT APPLICABLE” will appear.

## Using the DIGITAL ZOOM function

(Only for still image-based computer (RGB) / still image-based HDMI signals input)

You can enlarge the center area. You can also change the location of the area to be enlarged.

D.ZOOM+



D.ZOOM-



buttons

### 1) Press the <D.ZOOM +> button / <D.ZOOM -> button on the remote control.

- The moving screen is displayed.
- The [DIGITAL ZOOM] individual adjustment screen is displayed when executing the menu operation. For details, refer to [DISPLAY OPTION] → [OTHER FUNCTIONS]. (➡ page 70)
- Pressing the <RETURN> button to cancel the function.

### ■ Button functions during [DIGITAL ZOOM]

Operation menu	Operation	Adjustment	Adjustment range
	Press the <D.ZOOM +> button or ► button.	Increases magnification.	1.0 ~ 3.0
	Press the <D.ZOOM -> button or ◀ button.	Decreases magnification.	

### ■ Button functions of moving screen

Operation menu	Operation	Adjustment
	Press the ▲▼ buttons.	Moves the area to the top or the bottom.
	Press the ◀▶ buttons.	Moves the area to the left or the right.

- When you have executed the operation of remote control directly, the individual adjustment screen is not displayed and the operation menu of the moving screen is displayed. At this time, you can adjust the magnification by using the <D.ZOOM +> button or <D.ZOOM -> button on the remote control.

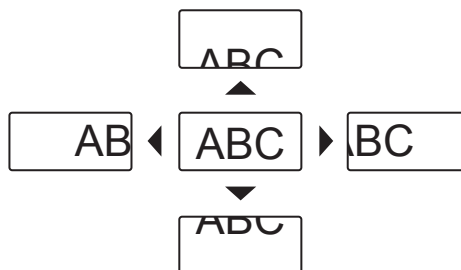

### Note

- Magnification can be set from 1.0x to 3.0x in 0.1 increments.
- The digital zoom function is canceled if the <MENU> button is pressed during a digital zoom.
- The digital zoom function is canceled if the input signal changes during a digital zoom.
- During a digital zoom, the freeze function is disabled.

## Using the FREEZE function

You can freeze the projected image and stop the sound temporarily, regardless of the playing condition of the external device.

FREEZE



button

### 1) Press <FREEZE> button on the remote control.

- The video is paused and the audio is muted. [FREEZE] is displayed on the lower left of the screen during FREEZE.

### 2) Press <FREEZE> button again.

- The video playback resumes and the audio is unmuted.

### Note

- When no signal input, [KEY NOT APPLICABLE] message will appear.
- When [MIC] is set to [ON], the audio of MIC can be output even during FREEZE.

## Using the AV MUTE function

If the projector is not used for a certain period of time during the meeting intermission, for example, it is possible to turn off the audio and image temporarily.



**1) Press the <AV MUTE> button on the remote control.**

- The audio and image turn off.

**2) Press the <AV MUTE> button again.**

- The audio and image turn on.

### Note

- When [MIC] is set to [ON], the audio of MIC can be output even during AV MUTE.

## Using the P-TIMER function

You can operate the P-TIMER function.

Presentations, etc. can be performed while checking the elapsed time or time remaining in the preset time.



**1) Press the <P-TIMER> button on the remote control.**

- The count is started.
- The elapsed time or the remaining time is displayed at the bottom right of the projected image.

**2) Press the <P-TIMER> button again.**

- The count is stopped.

**3) Press the <P-TIMER> button again.**

- The count is resumed.

### Note

- Pressing the <P-TIMER> button for at least 3 seconds to release the P-TIMER function.
- For details, please refer to the [DISPLAY OPTION] menu → [P-TIMER]. (➔ page 69)

## Using the MUTE function

This button allows you to turn off the audio output temporarily.



**1) Press the <MUTE> button on the remote control.**

- The audio turns off.

**2) Press the <MUTE> button again.**

- The audio turns on.

## Setting the ID number of the remote control

When you use the system with multiple projectors, you can operate all the projectors simultaneously or each projector individually by using single remote control, if unique ID number is assigned to each projector.

After setting the ID number of the projector, set the same ID number to the remote control.

The factory default ID number of the projector is set to [ALL]. When using a single projector, press the <ID ALL> button on the remote control. Also, you can control a projector by pressing the <ID ALL> button on the remote control even if you do not know the projector ID.



**1) Press the <ID SET> button on the remote control.**

**2) Within five seconds, press the one-digit ID number set on the projector using the number (<1> - <6>) buttons.**

- If you press the <ID ALL> button, you can control the projectors regardless of the ID number setting of the projector.

**Attention**

---

- Since the ID number of the remote control can be set without the projector, do not press the <ID SET> button on the remote control carelessly. If the <ID SET> button is pressed and no number (<1> - <6>) buttons are pressed within five seconds, the ID number returns to its original value before the <ID SET> button was pressed.
- The ID number set on the remote control will be stored unless it is set again. However, it will be erased if the remote control is left with dead batteries. Set the same ID number again when the batteries are replaced.

**Note**

---

- Set the ID number of the projector from the [PROJECTOR SETUP] menu → [PROJECTOR ID]. (➔ page 72)

# Chapter 4 **Settings**

---

This chapter describes the settings and adjustments you can make using the on-screen menu.

# Menu Navigation

The on-screen menu (Menu) is used to perform various settings and adjustments of the projector.

## Navigating through the menu

### Operating procedure



1) Press the <MENU> button on the remote control or the control panel.

- The main menu screen appears.



2) Press ▲▼ to select an item from the main menu.

- The selected item is highlighted in yellow.



3) Press the <ENTER> button.

- The submenu is displayed, and submenu items become selectable.



4) Press ▲▼ to select the desired sub-menu item, press ◀▶ or the <ENTER> button to set or adjust settings.

- Some items will switch in order as follows each time you press ◀▶.

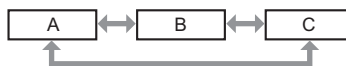

- For some items, press ◀▶ to display an individual adjustment screen with a bar scale as shown below.





**Note**

- Pressing the <MENU> button or <RETURN> button while the menu screen is displayed returns to the previous menu.
- Some items may not be adjusted or used for certain signal formats to be input to the projector. The menu items that cannot be adjusted or used are shown in gray characters, and they cannot be selected. [DIGITAL CINEMA REALITY] and [FRAME LOCK] may not be displayed depending on the input signal.
- Some items can be adjusted even if signals are not input.
- Individual adjustment screen is cleared automatically if no operation is performed for approximately five seconds.
- For menu items, refer to “Main menu” (➔ page 49) and “Sub menu” (➔ page 49).

**Resetting adjustment values to the factory default**

If the <DEFAULT> button on the remote control is pressed, the values adjusted in the menu items are restored to the factory default settings.

DEFAULT



button

1) Press the <DEFAULT> button on the remote control.







**Note**

- You cannot reset all the settings to the factory default at a time.
- To reset all the settings adjusted in the sub-menu item to the factory default at a time, execute the [PROJECTOR SETUP] menu → [INITIALIZE ALL]. (➔ page 77)
- Some items cannot be reset by pressing the <DEFAULT> button. Adjust each item manually.

**Main menu**

The main menu consists of the following 7 menu items.

When a main menu item is selected, the screen changes to a submenu selection screen.

	Main-menu item	Page
	[PICTURE]	52
	[POSITION]	57
	[LANGUAGE]	64
	[DISPLAY OPTION]	65
	[PROJECTOR SETUP]	71
	[SECURITY]	78
	[NETWORK]	81

**Sub menu**

The sub-menu screen of the selected main menu appears, and you can set and adjust the various items in the submenu.

**[PICTURE]** 

Sub-menu item	Factory default	Page
[PICTURE MODE]	[STANDARD]	52
[CONTRAST]	[0]	52

Sub-menu item	Factory default	Page
[BRIGHTNESS]	[0]	52
[COLOR]*1	[0]	53
[TINT]*1	[0]	53
[SHARPNESS]	[8]	53
[COLOR TEMPERATURE]	[DEFAULT]	53
[IRIS]	[ON]	54
[ADVANCED MENU]	-	54
[DAYLIGHT VIEW]	[AUTO]	54
[DIGITAL CINEMA REALITY]*1	[ON]	55
[NOISE REDUCTION]*2	[OFF]	55
[TV-SYSTEM]*2	[AUTO]	55
[RGB/YP <sub>B</sub> P <sub>R</sub> ] / [RGB/YC <sub>B</sub> C <sub>R</sub> ]*3	[AUTO]	55

\*1 Only for movie-based signals.

\*2 Only when the <VIDEO IN> terminal is selected.

\*3 Only when the <COMPUTER 1 IN> / <COMPUTER 2 IN/1 OUT> / <HDMI 1 IN> / <HDMI 2 IN> terminal is selected.

### Note

- The factory default settings may vary depending on the picture mode.

## [POSITION]

Sub-menu item	Factory default	Page
[REALTIME KEYSTONE]	[ON]	57
[SCREEN ADJUSTMENT]	-	57
[SHIFT]	-	61
[DOT CLOCK]*1	[0]	61
[CLOCK PHASE]*1	[0]	61
[OVER SCAN]	-	62
[ASPECT]	-	62
[FRAME LOCK]*1	[OFF]	63

\*1 Only for still image signals.

## [LANGUAGE]

Details (→ page 64)

## [DISPLAY OPTION]

Sub-menu item	Factory default	Page
[ON-SCREEN DISPLAY]	-	65
[HDMI SIGNAL LEVEL]	[AUTO]	66
[CLOSED CAPTION SETTING]	-	66
[SCREEN SETTING]	-	67
[STARTUP LOGO]	[DEFAULT LOGO]	68
[AUTO SETUP SETTING]	[AUTO]	68
[SIGNAL SEARCH]	[ON]	68
[BACK COLOR]	[BLUE]	68
[WIDE MODE]	-	69
[SXGA MODE]	-	69
[P-TIMER]	-	69
[OTHER FUNCTIONS]	-	70

## [PROJECTOR SETUP]

Sub-menu item	Factory default	Page
[STATUS]	-	71
[COMPUTER1 INPUT SETTING]	[RGB/YP <sub>B</sub> P <sub>R</sub> ]	71
[COMPUTER2 SELECT]	[COMPUTER2 IN]	71
[PROJECTOR ID]	[ALL]	72
[INITIAL START UP]	[LAST MEMORY]	72

Sub-menu item	Factory default	Page
[PROJECTION METHOD]	[FRONT/DESK]	72
[LAMP POWER]	[NORMAL]	72
[ECO MANAGEMENT]	-	73
[EMULATE]	[DEFAULT]	74
[FUNCTION BUTTON]	-	74
[AUDIO SETTING]	-	75
[TEST PATTERN]	-	76
[FILTER COUNTER]	-	77
[INITIALIZE ALL]	-	77

**[SECURITY]** 

Sub-menu item	Factory Default	Page
[PASSWORD]	[OFF]	78
[PASSWORD CHANGE]	-	78
[TEXT DISPLAY]	[OFF]	79
[TEXT CHANGE]	-	79
[MENU LOCK]	[OFF]	79
[MENU LOCK PASSWORD]	-	79
[CONTROL DEVICE SETUP]	-	80

**[NETWORK]** 

Sub-menu item	Factory default	Page
[WIRED LAN]	-	81
[NAME CHANGE]	-	81
[NETWORK CONTROL]	[ON]	82
[AMX D. D.]	[OFF]	82
[Crestron Connected(TM)]	[OFF]	82
[STATUS]	-	82
[INITIALIZE]	-	82

**Note**

- Some items may not be adjusted or used for certain signal formats to be input to the projector.  
The menu items that cannot be adjusted or used are shown in gray characters, and they cannot be selected.
- Sub-menu items and factory default settings differ depending on the selected input terminal.

## [PICTURE] menu

On the menu screen, select [PICTURE] from the main menu, and select an item from the submenu. Refer to "Navigating through the menu" (➔ page 48) for the operation of the menu screen.

- After selecting the item, press ▲▼◀▶ to set.

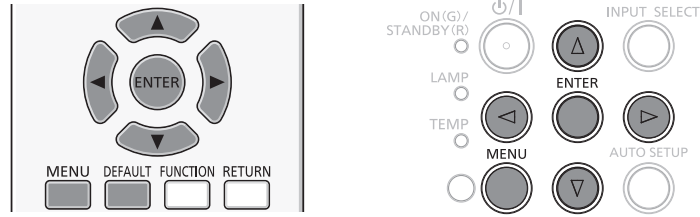

### [PICTURE MODE]

You can switch to the desired picture mode suitable for the image source and the environment in which the projector is used.

- 1) Press ▲▼ to select [PICTURE MODE].
- 2) Press ◀▶ or the <ENTER> button.
  - The [PICTURE MODE] individual adjustment screen is displayed.
- 3) Press ◀▶ to switch the item.
  - The items will switch each time you press the button.

[STANDARD]	The picture becomes suitable for moving images in general.
[DYNAMIC]	The light output is maximized for use in bright areas.
[BLACKBOARD]	The picture becomes suitable for projecting on a black board.
[WHITE BOARD]	The picture becomes suitable for projecting on a white board.
[CINEMA]*1	The picture becomes suitable for movie sources.
[NATURAL]*2	The picture becomes suitable for use in low-light areas.

\*1 Only for the movie-based signals.

\*2 Only for the still image signals.

### [CONTRAST]

You can adjust the contrast of the colors.

- 1) Press ▲▼ to select [CONTRAST].
- 2) Press ◀▶ or the <ENTER> button.
  - The [CONTRAST] individual adjustment screen is displayed.
- 3) Press ◀▶ to adjust the level.

Operation	Adjustment	Adjustment range
Press the ▶ button.	Brightens the screen and makes the color of image deeper.	-32 ~ +32
Press the ◀ button.	Darkens the screen and makes the color of image lighter.	

#### Attention

- Adjust [BRIGHTNESS] first when you need to adjust [BRIGHTNESS] and [CONTRAST].

### [BRIGHTNESS]

You can adjust the dark (black) part of the projected image.

- 1) Press ▲▼ to select [BRIGHTNESS].
- 2) Press ◀▶ or the <ENTER> button.
  - The [BRIGHTNESS] individual adjustment screen is displayed.
- 3) Press ◀▶ to adjust the level.

Operation	Adjustment	Adjustment range
Press the ► button.	Increases the brightness of the dark (black) parts of the screen.	-32 ~ +32
Press the ◀ button.	Reduces the brightness of the dark (black) parts of the screen.	

## [COLOR]

(Only for movie-based signal input)

You can adjust the color saturation of the projected image.

- 1) Press ▲▼ to select [COLOR].
- 2) Press ◀▶ or the <ENTER> button.
  - The [COLOR] individual adjustment screen is displayed.
- 3) Press ◀▶ to adjust the level.

Operation	Adjustment	Adjustment range
Press the ► button.	Deepens colors.	-32 ~ +32
Press the ◀ button.	Weakens colors.	

## [TINT]

(Only for NTSC/NTSC4.43 signal when input movie-based signal and the <VIDEO IN> terminal is selected)

You can adjust the skin tone in the projected image.

- 1) Press ▲▼ to select [TINT].
- 2) Press ◀▶ or the <ENTER> button.
  - The [TINT] individual adjustment screen is displayed.
- 3) Press ◀▶ to adjust the level.

Operation	Adjustment	Adjustment range
Press the ► button.	Adjusts skin tone toward greenish color.	-32 ~ +32
Press the ◀ button.	Adjusts skin tone toward reddish purple.	

## [SHARPNESS]

You can adjust the sharpness of the projected image.

- 1) Press ▲▼ to select [SHARPNESS].
- 2) Press ◀▶ or the <ENTER> button.
  - The [SHARPNESS] individual adjustment screen is displayed.
- 3) Press ◀▶ to adjust the level.

Operation	Adjustment	Adjustment range
Press the ► button.	Contours become sharper.	0 ~ +15
Press the ◀ button.	Contours become softer.	

### Note

- [SHARPNESS] will be invalid when [DAYLIGHT VIEW] is set to [AUTO] or [ON].

## [COLOR TEMPERATURE]

You can switch the color temperature if the white areas of the projected image are bluish or reddish.

- 1) Press ▲▼ to select [COLOR TEMPERATURE].
- 2) Press ◀▶ or the <ENTER> button.
  - The [COLOR TEMPERATURE] individual adjustment screen is displayed.
- 3) Press ◀▶ to switch the item.
  - The items will switch each time you press the button.

[DEFAULT]	Factory default setting.
[HIGH]	Becomes a bluish image. Select this when the white areas of the projected image are reddish.
[LOW]	Becomes a reddish image. Select this when the white areas of the projected image are bluish.

## [IRIS]

Aperture correction and signal compensation are performed automatically based on the image to result in an image of optimum contrast.

- 1) Press ▲▼ to select [IRIS].
- 2) Press ◀▶ or the <ENTER> button.
  - The [IRIS] individual adjustment screen is displayed.
- 3) Press ◀▶ to switch the item.
  - The items will switch each time you press the button.

[OFF]	No correction.
[ON]	Corrects the aperture.

## [ADVANCED MENU]

You can perform more advanced image adjustment.

- 1) Press ▲▼ to select [ADVANCED MENU].
- 2) Press the <ENTER> button.
  - The [ADVANCED MENU] screen is displayed.
- 3) Press ▲▼ to select one item among [CONTRAST R] ~ [BRIGHTNESS B].
- 4) Press ◀▶ or the <ENTER> button.
  - The individual adjustment screen of items are displayed.
- 5) Press ◀▶ to adjust the value.

Items	Operation	Adjustment	Adjustment range
[CONTRAST R]	Press the ▶ button.	Emphasizes red in highlight areas.	-32 ~ +32
	Press the ◀ button.	Deemphasizes red in highlight areas.	
[CONTRAST G]	Press the ▶ button.	Emphasizes green in highlight areas.	-32 ~ +32
	Press the ◀ button.	Deemphasizes green in highlight areas.	
[CONTRAST B]	Press the ▶ button.	Emphasizes blue in highlight areas.	-32 ~ +32
	Press the ◀ button.	Deemphasizes blue in highlight areas.	
[BRIGHTNESS R]	Press the ▶ button.	Emphasizes red in shadow areas.	-32 ~ +32
	Press the ◀ button.	Deemphasizes red in shadow areas.	
[BRIGHTNESS G]	Press the ▶ button.	Emphasizes green in shadow areas.	-32 ~ +32
	Press the ◀ button.	Deemphasizes green in shadow areas.	
[BRIGHTNESS B]	Press the ▶ button.	Emphasizes blue in shadow areas.	-32 ~ +32
	Press the ◀ button.	Deemphasizes blue in shadow areas.	

## [DAYLIGHT VIEW]

You can correct the image to the optimal vividness even if it is projected under a bright light.

- 1) Press ▲▼ to select [DAYLIGHT VIEW].
- 2) Press ◀▶ or the <ENTER> button.
  - The [DAYLIGHT VIEW] individual adjustment screen is displayed.
- 3) Press ◀▶ to switch the item.
  - The items will switch each time you press the button.

[AUTO]	Enables auto correction of [DAYLIGHT VIEW]. The brightness of the room is detected by the luminance sensor, and the vividness of the image is automatically corrected.
[ON]	Enables [DAYLIGHT VIEW].
[OFF]	Disables [DAYLIGHT VIEW].

**Note**

- [DAYLIGHT VIEW] cannot be set to [AUTO] when the [PROJECTOR SETUP] menu → [PROJECTION METHOD] is set to [REAR/DESK] or [REAR/CEILING].
- The [AUTO] mode may not function properly if an object is placed on the top of the projector.

**[DIGITAL CINEMA REALITY]**

(Only for movie-based signal input)

You can improve the vertical resolution of 2-2 and 2-3 pull down video.

This function is available only with the following signal inputs.

525i (480i), 625i (576i), 1125 (1080)/60i, 1125 (1080)/50i, Y/C signal, VIDEO signal.

- 1) Press ▲▼ to select [DIGITAL CINEMA REALITY].
- 2) Press ◀▶ or the <ENTER> button.
  - The [DIGITAL CINEMA REALITY] individual adjustment screen is displayed.
- 3) Press ◀▶ to switch the item.
  - The items will switch each time you press the button.

[OFF]	Disables [DIGITAL CINEMA REALITY].
[ON]	Enables [DIGITAL CINEMA REALITY].

**[NOISE REDUCTION]**

(Only when the <VIDEO IN> terminal or <COMPUTER 1 IN> terminal\*1 is selected)

You can reduce noises when the input image is degraded and noise is occurring in the image signal.

- 1) Press ▲▼ to select [NOISE REDUCTION].
- 2) Press ◀▶ or the <ENTER> button.
  - The [NOISE REDUCTION] individual adjustment screen is displayed.
- 3) Press ◀▶ to switch the item.
  - The items will switch each time you press the button.

[OFF]	Disables [NOISE REDUCTION].
[ON]	Enables [NOISE REDUCTION].

\*1 When [COMPUTER1 INPUT SETTING] is set to [Y/C] (➔ page 71)

**Attention**

- When this is set for an input signal with less noise, the image may look different from what it originally was. In such a case, set it to [OFF].

**[TV-SYSTEM]**

(Only when the <VIDEO IN> terminal or <COMPUTER 1 IN> terminal\*1 is selected)

The projector will automatically detect the input signal, but you can set the color system manually when an unstable signal is input. Set the color system matching the input signal.

\*1 When [COMPUTER1 INPUT SETTING] is set to [Y/C] (➔ page 71)

- 1) Press ▲▼ to select [TV-SYSTEM].
- 2) Press ◀▶ or the <ENTER> button.
  - The [TV-SYSTEM] individual adjustment screen is displayed.
- 3) Press ◀▶ to select the color system.
  - The items will switch each time you press the button.
  - Select among [AUTO], [NTSC], [NTSC4.43], [PAL], [PAL-M], [PAL-N], [PAL60] and [SECAM].
  - Set it to [AUTO] normally. (Setting [AUTO] will automatically select [NTSC], [NTSC4.43], [PAL], [PAL-M], [PAL-N], [SECAM], or [PAL60].)

**[RGB/YP<sub>B</sub>P<sub>R</sub>] / [RGB/YC<sub>B</sub>C<sub>R</sub>]**

Set it to [AUTO] normally. If images are not displayed correctly when this is set to [AUTO], set either [RGB], [YC<sub>B</sub>C<sub>R</sub>] or [YP<sub>B</sub>P<sub>R</sub>] in accordance with the input signal.

- 1) Press ▲▼ to select [RGB/YP<sub>B</sub>P<sub>R</sub>] or [RGB/YC<sub>B</sub>C<sub>R</sub>].

2) Press ◀▶ or the <ENTER> button.

- The [RGB/YP<sub>B</sub>P<sub>R</sub>] or [RGB/YC<sub>B</sub>C<sub>R</sub>] individual adjustment screen is displayed.

3) Press ◀▶ to switch the item.

- The items will switch each time you press the button.

[AUTO]	The sync signal automatically selects the signal [RGB] / [YP <sub>B</sub> P <sub>R</sub> ] / [YC <sub>B</sub> C <sub>R</sub> ].
[RGB]	Select it for RGB signal input.
[YP <sub>B</sub> P <sub>R</sub> ]	Select it for YP <sub>B</sub> P <sub>R</sub> signal input.
[YC <sub>B</sub> C <sub>R</sub> ]	Select it for YC <sub>B</sub> C <sub>R</sub> signal input.

**When the <COMPUTER 1 IN> / <COMPUTER 2 IN/1 OUT>\*1 terminal is selected**

• **For 525i(480i), 625i(576i), 525p(480p) and 625p(576p) input**

Select [AUTO], [RGB] or [YC<sub>B</sub>C<sub>R</sub>].

• **For other movie-based signal input**

Select [AUTO], [RGB] or [YP<sub>B</sub>P<sub>R</sub>].

\*1 When the <COMPUTER 2 IN/1 OUT> terminal is used as <COMPUTER 2 IN> terminal

**When the <HDMI 1 IN> / <HDMI 2 IN> terminal is selected**

• **For 525p(480p) and 625p(576p) input**

Select [AUTO], [RGB] or [YC<sub>B</sub>C<sub>R</sub>].

• **For other movie-based signal input**

Select [AUTO], [RGB] or [YP<sub>B</sub>P<sub>R</sub>].

**Note**

- Refer to “List of compatible signals” (➔ page 112) for the signal details.
- The signal selection may not function properly depending on connected devices.



## [POSITION] menu

On the menu screen, select [POSITION] from the main menu, and select an item from the submenu. Refer to "Navigating through the menu" (➔ page 48) for the operation of the menu screen.

- After selecting the item, press ▲▼◀▶ to set.

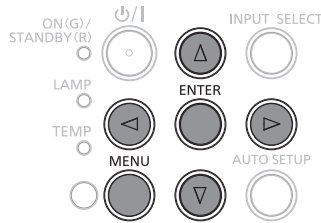
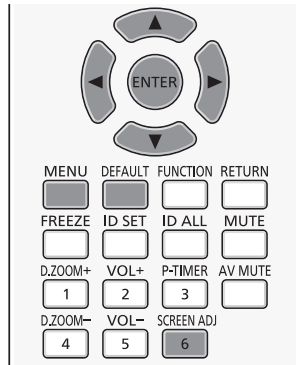

## [REALTIME KEYSTONE]

The projector can correct the vertical trapezoidal distortion automatically when the projector is installed tilted.

- 1) Press ▲▼ to select [REALTIME KEYSTONE].
- 2) Press ◀▶ or the <ENTER> button.
  - The [REALTIME KEYSTONE] individual adjustment screen is displayed.
- 3) Press ◀▶ to switch the item.
  - The items will switch each time you press the button.

[OFF]	Set this function to off.
[ON]	Executes vertical keystone correction automatically when the projector is installed tilted.

### Note

- In some times the realtime keystone function maybe correct image imperfectly, manual keystone is required.
- The [REALTIME KEYSTONE] function cannot work when the [FRONT/CEILING] or [REAR/CEILING] feature is selected in [PROJECTION METHOD] in the [PROJECTOR SETUP] menu.

## [SCREEN ADJUSTMENT]

You can correct the distortion of the projected image that occurs when the projector is installed tilted or when the screen is tilted or curved.

- 1) Press ▲▼ to select [SCREEN ADJUSTMENT].
- 2) Press the <ENTER> button.
  - The [SCREEN ADJUSTMENT] screen is displayed.
- 3) Press ▲▼ to select one item to adjust.

[KEystone]	Adjusts when the trapezoid of the projected image is distorted.
[CORNER CORRECTION]	Adjusts when the four corners of the projected image are distorted.
[CURVED CORRECTION]	Adjusts when the linearity is not uniform or the projected image is curved distortion.

### Setting [KEYSTONE]

- 1) Press ▲▼ to select [SCREEN ADJUSTMENT].
- 2) Press the <ENTER> button.
  - The [SCREEN ADJUSTMENT] screen is displayed.
- 3) Press ▲▼ to select [KEYSTONE].

- 4) Press the <ENTER> button.
  - The [KEystone] individual adjustment screen is displayed.
- 5) Press ▲▼ to select one item to adjust.

[LENS THROW RATIO]	Set the throw ratio. Select an approximate value that is the actual projection distance divided by the projected image width.
[KEYSTONE]	Adjusts when the trapezoid of the projected image is distorted.
[BALANCE]	Adjusts according to the lens shift range in the horizontal or vertical direction.

**Adjusting [LENS THROW RATIO]**

- 1) Press ▲▼ to select [SCREEN ADJUSTMENT].
- 2) Press the <ENTER> button.
  - The [SCREEN ADJUSTMENT] screen is displayed.
- 3) Press ▲▼ to select [KEYSTONE].
- 4) Press the <ENTER> button.
  - The [KEYSTONE] screen is displayed.
- 5) Press ▲▼ to select [LENS THROW RATIO].
- 6) Press the <ENTER> button.
  - The [LENS THROW RATIO] individual adjustment screen is displayed.
- 7) Press ◀▶ to adjust the item.
  - The adjustment values are [0.9] to [2.3].

**Adjusting [KEYSTONE]**

- 1) Press ▲▼ to select [SCREEN ADJUSTMENT].
- 2) Press the <ENTER> button.
  - The [SCREEN ADJUSTMENT] screen is displayed.
- 3) Press ▲▼ to select [KEYSTONE].
- 4) Press the <ENTER> button.
  - The [KEYSTONE] screen is displayed.
- 5) Press ▲▼ to select [KEYSTONE].
- 6) Press the <ENTER> button.
  - The [KEYSTONE] individual adjustment screen is displayed.
- 7) Press ▲▼◀▶ to adjust the item.

Items	Operation		Adjustment
[H]	Press the ◀ button.	Left side will be smaller.	
	Press the ▶ button.	Right side will be smaller.	
[V]	Press the ▲ button.	Upper will be smaller.	
	Press the ▼ button.	Lower will be smaller.	

Adjusting [BALANCE]

- 1) Press ▲▼ to select [SCREEN ADJUSTMENT].
- 2) Press the <ENTER> button.
  - The [SCREEN ADJUSTMENT] screen is displayed.
- 3) Press ▲▼ to select [KEYSTONE].
- 4) Press the <ENTER> button.
  - The [KEYSTONE] screen is displayed.
- 5) Press ▲▼ to select [BALANCE].
- 6) Press the <ENTER> button.
  - The [BALANCE] individual adjustment screen is displayed.
- 7) Press ◀▶ to adjust the balance.

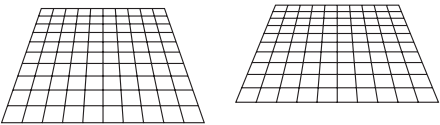
Adjustment	
Adjusts the balance according to the amount of the vertical lens shift adjustment.	

Setting [CORNER CORRECTION]

- 1) Press ▲▼ to select [SCREEN ADJUSTMENT].
- 2) Press the <ENTER> button.
  - The [SCREEN ADJUSTMENT] screen is displayed.
- 3) Press ▲▼ to select [CORNER CORRECTION].
- 4) Press the <ENTER> button.
  - The [CORNER CORRECTION] screen is displayed.
- 5) Press ▲▼ to select the item to adjust, then press the <ENTER> button.
  - The [CORNER CORRECTION] individual adjustment screen is displayed.
- 6) Press ▲▼◀▶ to adjust.

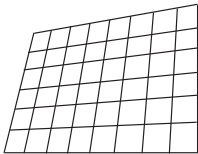
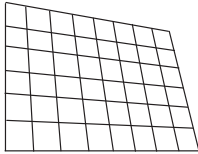
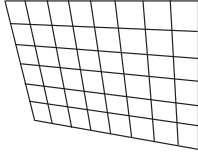
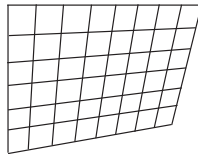
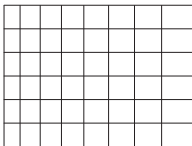
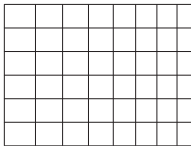
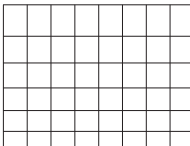
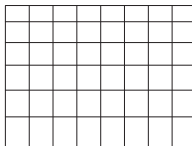
[CORNER CORRECTION]			
[UPPER LEFT]	[UPPER RIGHT]	[LOWER LEFT]	[LOWER RIGHT]
			
[LINEARITY] Horizontal direction		[LINEARITY] Vertical direction	
			

Setting [CURVED CORRECTION]

- 1) Press ▲▼ to select [SCREEN ADJUSTMENT].
- 2) Press the <ENTER> button.
  - The [SCREEN ADJUSTMENT] screen is displayed.

- 3) Press ▲▼ to select [CURVED CORRECTION].
- 4) Press the <ENTER> button.
  - The [CURVED CORRECTION] screen is displayed.
- 5) Press ▲▼ to select one item to adjust.

[LENS THROW RATIO]	Set the throw ratio. Select an approximate value that is the actual projection distance divided by the projected image width.
[KEYSTONE]	Adjusts when the trapezoid of the projected image is distorted.
[ARC]	Adjusts when the radian of the projected image is distorted.
[BALANCE]	Adjusts according to the lens shift range in the horizontal or vertical direction.
[MAINTAIN ASPECT RATIO]	Set to [ON], maintain the aspect ratio when correct the curved distortion of the projected image.

- 6) Press the <ENTER> button.
  - The individual adjustment screen of the selected function is displayed.

#### Adjusting [LENS THROW RATIO]

- 1) Press ◀▶ to adjust.
  - For details, please refer to “Setting [KEYSTONE]” → “Adjusting [LENS THROW RATIO]” (➡ page 58).

#### Adjusting [KEYSTONE]

- 1) Press ▲▼◀▶ to adjust.
  - For details, please refer to “Setting [KEYSTONE]” → “Adjusting [KEYSTONE]” (➡ page 58).

#### Adjusting [ARC]

- 1) Press ▲▼◀▶ to adjust.

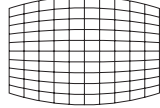
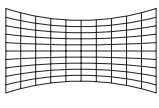
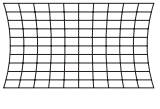
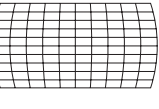
Items	Operation	Adjustment		
[H]	Press the ◀ button.	The top and the bottom of horizontal line will be bulge.		
	Press the ▶ button.	The top and the bottom of horizontal line will be dent.		
[V]	Press the ▲ button.	The left and the right of vertical line will be dent.		
	Press the ▼ button.	The left and the right of vertical line will be bulge.		

#### Adjusting [BALANCE]

- 1) Press ◀▶ to adjust.
  - For details, please refer to “Setting [KEYSTONE]” → “Adjusting [BALANCE]” (➡ page 59).

#### Note

- One of [KEYSTONE], [CORNER CORRECTION] and [CURVED CORRECTION] setting value is valid. When [KEYSTONE], [CORNER CORRECTION] or [CURVED CORRECTION] adjustment is finished, you adjust the others, the adjusted value will be reset.
- Press the <SCREEN ADJ> button on the remote control when the [KEYSTONE], [CORNER CORRECTION] or [CURVED CORRECTION] screen is displaying, it will switch to the next adjustment screen.
- When the [CORNER CORRECTION] individual adjustment screen is displaying, the individual adjustment screen of the next corner can also be displayed by pressing the <ENTER> button.

- Correcting up to  $\pm 25^\circ$  for the tilt in the vertical direction and  $\pm 30^\circ$  for the tilt in the horizontal are available for adjustments with [KEYSTONE]. However, the image quality will degrade and it will get harder to focus with more correction. Install the projector so that the correction will be as small as possible.
- Screen size will also change when [KEYSTONE] is used to perform various adjustments.
- Aspect ratio of the image size may shift depending on the correction.

## [SHIFT]

(Only for computer (RGB) signals and  $Y_C B_C R / Y_P B_P R$  signals input)

Move the image position vertically or horizontally if the image position projected on the screen is shifted even when the relative position of the projector and the screen is installed correctly.

- 1) Press **▲▼** to select [SHIFT].
- 2) Press the **<ENTER>** button.
  - The [SHIFT] screen is displayed.
- 3) Press **▲▼◀▶** to adjust the position.

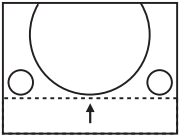
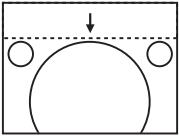
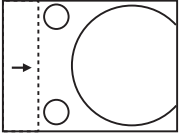
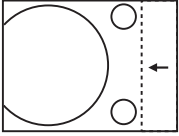
Orientation	Operation	Adjustment	
Vertical (up and down) adjustment.	Press the <b>▲</b> button.	The image position moves up.	
	Press the <b>▼</b> button.	The image position moves down.	
Horizontal (right and left) adjustment.	Press the <b>▶</b> button.	The image position moves to the right.	
	Press the <b>◀</b> button.	The image position moves to the left.	

## [DOT CLOCK]

(Only for computer (RGB) signals input)

Use this function to adjust and minimize the effect of interference caused by projection of patterns consisting of vertical stripes. The projection of the striped pattern may cause cyclic patterns (noise). Adjust so that the amount of interference is at a minimum. You can adjust the dot clock of image.

- 1) Press **▲▼** to select [DOT CLOCK].
- 2) Press **◀▶** or the **<ENTER>** button.
  - The [DOT CLOCK] individual adjustment screen is displayed.
- 3) Press **◀▶** to adjust the value.
  - The adjustment values are [-32] to [+32].

### Attention

- Set it before adjusting [CLOCK PHASE].

## [CLOCK PHASE]

(Only for computer (RGB) signals and  $Y_C B_C R / Y_P B_P R$  signals input)

You can adjust to achieve an optimal image when there is a flickering image or smeared outlines.

- 1) Press **▲▼** to select [CLOCK PHASE].
- 2) Press **◀▶** or the **<ENTER>** button.
  - The [CLOCK PHASE] individual adjustment screen is displayed.

3) Press ◀▶ to adjust the value.

- Adjustment value will change between [-16] and [+16]. Adjust so that the amount of interference is at a minimum.

**Note**

- Certain signals may not be adjustable.
- Optimal value may not be achieved if the output from the input computer is unstable.
- To project a signal with dot clock frequency with 162 MHz or higher, noise may not disappear even if [CLOCK PHASE] is adjusted.
- [CLOCK PHASE] cannot be adjusted when a digital signal is input.

**[OVER SCAN]**

Use this function when characters or pictures are cropped near the periphery of the projected image.

1) Press ▲▼ to select [OVER SCAN].

2) Press ◀▶ or the <ENTER> button.

- The [OVER SCAN] individual adjustment screen is displayed.

3) Press ◀▶ to adjust the level.

- The adjustment values are [0] to [+3].

**Note**

- It is unavailable for still image computer (RGB) signals and still image HDMI signals.

**[ASPECT]**

You can switch the aspect ratio of the image.

The aspect ratio is switched within the screen range selected in [SCREEN SETTING].

Set [SCREEN SETTING] first. (➔ page 67)

1) Press ▲▼ to select [ASPECT].

2) Press ◀▶ or the <ENTER> button.

- The [ASPECT] individual adjustment screen is displayed.

3) Press ◀▶ to switch the item.

- The items will switch each time you press the button.

[NORMAL]	Displays images without changing the aspect ratio of the input signals.
[AUTO]*1	The aspect ratio is automatically switched to the optimum aspect ratio when an aspect ratio identifier is included in the input signal.
[WIDE]	Displays images with the aspect ratio converted to 16:9 when standard signals*2 are input. Display images without changing the aspect ratio when wide-screen signals*3 are input.
[H FIT]	Displays images using the entire width of the screen. When signals have the aspect ratio vertically longer than the aspect ratio of the screen selected in [SCREEN FORMAT], the images are displayed with the top and bottom parts cut off.
[V FIT]	Displays the height of the panel pixels vertically without changing the aspect ratio when wide-screen signals are input. When signals have the aspect ratio horizontally longer than the aspect ratio of the screen, the images are displayed with the right and left parts cut off.
[FULL]	The image is projected using all the panel (screen) pixels. The input signals are converted to the aspect ratio of the panel (screen).
[NATIVE]	Displays images without changing the resolution of the input signals.

\*1 Only for Video (NTSC) and 480i (YCbCr) signals input

\*2 Standard signals are input signals with an aspect ratio of 4:3 or 5:4.

\*3 Wide-screen signals are input signals with an aspect ratio of 16:10, 16:9 or 15:9.

**Note**

- The image size may be switched abnormally when [AUTO] is selected, please set to [NORMAL] or [WIDE] according to the input signal.
- Some size modes are not available for certain types of input signals.
- If an aspect ratio which is different from the aspect ratio for the input signals is selected, the images will appear differently from the originals. Be careful of this when selecting the aspect ratio.
- If using the projector in places such as cafes or hotels to display programs for a commercial purpose or for public presentation, note that adjusting the aspect ratio or using the zoom function to change the screen images may be an infringement of the rights of the original copyright owner for that program under copyright protection laws. Take care when using a function of the projector such as the aspect ratio adjustment and zoom function.

- If conventional (normal) 4:3 images which are not wide-screen images are displayed on a wide screen, the edges of the images may not be visible or they may become distorted. Such images should be viewed as with an aspect ratio of 4:3 in the original format intended by the creator of the images.

## [FRAME LOCK]

---

(Only for still image signals input)

This setting is available for specific computer signals. Set when the movie is distorted.

- 1) Press ▲▼ to select [FRAME LOCK].
- 2) Press ◀▶ or the <ENTER> button.
  - The [FRAME LOCK] individual adjustment screen is displayed.
- 3) Press ◀▶ to switch the [FRAME LOCK].
  - The items will switch each time you press the button.

[OFF]	Disables the frame lock.
[ON]	Enables the frame lock.

## [LANGUAGE] menu

On the menu screen, select [LANGUAGE] from the main menu, and select an item from the submenu. Refer to "Navigating through the menu" (➔ page 48) for the operation of the menu screen.

- Press ▲▼ to select a language, and press <ENTER> button to set.

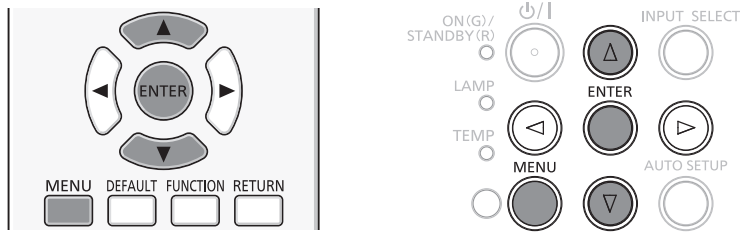

### [LANGUAGE]

You can select the language of the on-screen display.



- Various menus, settings, adjustment screens, control button names, etc., are displayed in the selected language.
- The language can be changed to English, German, French, Italian, Spanish, Portuguese, Dutch, Swedish, Finnish, Norwegian, Danish, Polish, Hungarian, Romanian, Czech, Russian, Turkish, Arabic, Kazakh, Vietnamese, Chinese, Korean, Japanese and Thai.

### Note

- The on-screen display language of the projector is set to English by default and when [INITIALIZE ALL] (➔ page 77) in [PROJECTOR SETUP] is executed.



## [DISPLAY OPTION] menu

On the menu screen, select [DISPLAY OPTION] from the main menu, and select an item from the submenu. Refer to "Navigating through the menu" (➔ page 48) for the operation of the menu screen.

- After selecting the item, press ▲▼◀▶ to set.

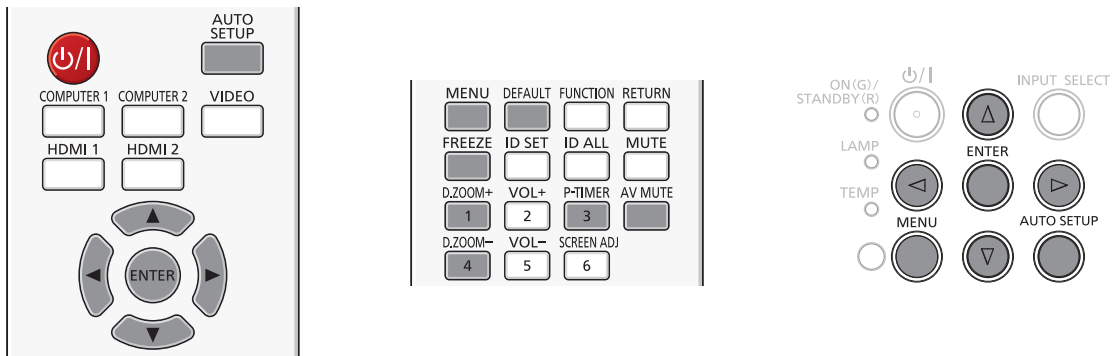

### [ON-SCREEN DISPLAY]

Set the on-screen display and position.

#### [INPUT GUIDE]

Set whether to display the input guide when switching the input source.

- 1) Press ▲▼ to select [ON-SCREEN DISPLAY].
- 2) Press the <ENTER> button.
  - The [ON-SCREEN DISPLAY] screen is displayed.
- 3) Press ▲▼ to select [INPUT GUIDE].
- 4) Press ◀▶ to switch the item.
  - The items will switch each time you press the button.

[DETAILED]	Displays the name of input terminal and input signal graphically.
[OFF]	Disables the input guide.
[SIMPLE]	Displays the name of input terminal and input signal.

#### [OSD POSITION]

Set the position of the menu screen (OSD).

- 1) Press ▲▼ to select [ON-SCREEN DISPLAY].
- 2) Press the <ENTER> button.
  - The [ON-SCREEN DISPLAY] screen is displayed.
- 3) Press ▲▼ to select [OSD POSITION].
- 4) Press ◀▶ to switch the item.
  - The items will switch each time you press the button as following:  
[CENTER] → [UPPER LEFT] → [UPPER RIGHT] → [LOWER LEFT] → [LOWER RIGHT] → [CENTER] → ...

#### [OSD SIZE]

Set the size of the menu screen (OSD).

- 1) Press ▲▼ to select [ON-SCREEN DISPLAY].
- 2) Press the <ENTER> button.
  - The [ON-SCREEN DISPLAY] screen is displayed.
- 3) Press ▲▼ to select [OSD SIZE].

4) Press ◀▶ to switch the item.

[NORMAL]	Use this setting normally.
[DOUBLE]	Double angle size (height and width will become two times) of [NORMAL].

### [WARNING MESSAGE]

Set the display/hide of the warning message.

1) Press ▲▼ to select [ON-SCREEN DISPLAY].

2) Press the <ENTER> button.

- The [ON-SCREEN DISPLAY] screen is displayed.

3) Press ▲▼ to select [WARNING MESSAGE].

4) Press ◀▶ to switch the item.

- The items will switch each time you press the button.

[OFF]	Hides the warning message.
[ON]	Displays the warning message.

### [HDMI SIGNAL LEVEL]

Switch the setting when the external equipment is connected to the <HDMI 1 IN> / <HDMI 2 IN> terminal of the projector and the image is not projected correctly.

1) Press ▲▼ to select [HDMI SIGNAL LEVEL].

2) Press ◀▶ to switch the item.

- The items will switch each time you press the button.

[AUTO]	Sets the signal level automatically.
[64-940]	Select when the HDMI terminal of an external device (such as a blu-ray player) is connected to the <HDMI 1 IN> / <HDMI 2 IN> terminal.
[0-1023]	Select when the DVI terminal output of an external device (such as a computer) is connected to the <HDMI 1 IN> / <HDMI 2 IN> terminal via a conversion cable or similar cable. Select also when the HDMI terminal output of a computer or other device is connected to the <HDMI 1 IN> / <HDMI 2 IN> terminal.

#### Note

- The optimal setting varies depending on the output setting of the connected external device. Refer to the operation instruction of the external device regarding the output of the external device.
- The displayed signal level is assumed when the input is 30 bits.

### [CLOSED CAPTION SETTING] (Only for NTSC, 480i YC<sub>B</sub>C<sub>R</sub> input)

Set the closed caption.

#### Selecting the closed caption display

1) Press ▲▼ to select [CLOSED CAPTION SETTING].

2) Press the <ENTER> button.

- The [CLOSED CAPTION SETTING] screen is displayed.

3) Press ▲▼ to select [CLOSED CAPTION].

4) Press ◀▶ to switch the item.

- The items will switch each time you press the button.

[OFF]	Closed captions are not displayed.
[ON]	Closed captions are displayed.

- When [ON] is selected, proceed to Step 5).

5) When the confirmation is displayed, select [OK], and press the <ENTER> button.

### Setting the closed caption mode

- 1) Press ▲▼ to select [CLOSED CAPTION SETTING].
- 2) Press the <ENTER> button.
  - The [CLOSED CAPTION SETTING] screen is displayed.
- 3) Press ▲▼ to select [MODE].
- 4) Press ◀▶ to switch the item.
  - The items will switch each time you press the button.

[CC1]	Displays CC1 data.
[CC2]	Displays CC2 data.
[CC3]	Displays CC3 data.
[CC4]	Displays CC4 data.

### Note

- Closed caption is a function that displays text information of video signals mainly used in North America. Captions may not be displayed depending on the connected devices or contents being played back.
- [CLOSED CAPTION SETTING] can only be selected if an NTSC or 480i YC<sub>B</sub>C<sub>R</sub> signal is input.
- If [CLOSED CAPTION SETTING] is set to [ON], the brightness of image may be changed according to the external devices or the used content of the closed caption corresponding connection.
- If a closed caption signal of the selected mode is input, the text is not displayed even when the [SECURITY] menu → [TEXT DISPLAY] (▶ page 79) is set to [ON].
- Closed captions are not displayed when the menu screen is displayed.

### [SCREEN SETTING]

Set the screen size.

When changing the aspect of a projected image, correct to the optimum image position for the set screen. Set as necessary for the screen in use.

- 1) Press ▲▼ to select [SCREEN SETTING].
- 2) Press the <ENTER> button.
  - The [SCREEN SETTING] screen is displayed.
- 3) Press ▲▼ to select [SCREEN FORMAT].
- 4) Press ◀▶ to switch the [SCREEN FORMAT] item.
  - The items will switch each time you press the button.

[SCREEN FORMAT]	Description	Range when [SCREEN POSITION] is selected
[16:10]	The projected aspect ratio is 16:10.	The vertical position cannot be adjusted.
[16:9]	The projected aspect ratio is 16:9.	Adjusts the vertical position.
[4:3]	The projected aspect ratio is 4:3.	Adjusts the horizontal position.

- 5) Press ▲▼ to select [SCREEN POSITION].
  - If [SCREEN FORMAT] is set to [16:10], adjustment of [SCREEN POSITION] is not available.
- 6) Press ◀▶ to adjust the [SCREEN POSITION].
  - The items will switch each time you press the button.
  - When [SCREEN FORMAT] is [16:9]

[CENTER]	The image which aspect ratio is 16:9 will displayed in the center.
[HIGH]	The image which aspect ratio is 16:9 will displayed at the top.
[LOW]	The image which aspect ratio is 16:9 will displayed at the bottom.

- When [SCREEN FORMAT] is [4:3]

[CENTER]	The image which aspect ratio is 4:3 will displayed at the center.
[LEFT]	The image which aspect ratio is 4:3 will displayed in the left.
[RIGHT]	The image which aspect ratio is 4:3 will displayed at the right.

**[STARTUP LOGO]**

Set the logo display when the power is turned on.

- 1) Press ▲▼ to select [STARTUP LOGO].
- 2) Press ◀▶ to switch the item.

- The items will switch each time you press the button.

[OFF]	Disables the startup logo display.
[DEFAULT LOGO]	Displays the Panasonic logo.
[USER LOGO]	Displays the image registered by the user.

**Note**

- The startup logo will disappear in approximately 30 seconds.
- To create/register the [USER LOGO] image, use “Logo Transfer Software” included in the supplied CD-ROM.
- If you do not register the image of the [USER LOGO], the startup logo will not be displayed even if the [STARTUP LOGO] is set to [USER LOGO].

**[AUTO SETUP SETTING]**

Set the automatic execution of AUTO SETUP.

The screen display position or signal level can be adjusted automatically without pressing the <AUTO SETUP> button on the remote control or on the control panel on each occasion if you input unregistered signals frequently at meetings, etc.

- 1) Press ▲▼ to select [AUTO SETUP SETTING].
- 2) Press ◀▶ to switch the item.

- The items will switch each time you press the button.

[AUTO]	Enables the auto setup function when switching signals.
[BUTTON]	Enables the auto setup function only when the <AUTO SETUP> button is pressed.

**[SIGNAL SEARCH]**

When the power is turned on, this function automatically detects the terminal which signals are input and sets the function to switch.

- 1) Press ▲▼ to select [SIGNAL SEARCH].
- 2) Press ◀▶ to switch the item.

- The items will switch each time you press the button.

[OFF]	Disables input detection automatically.
[ON]	Enables input detection automatically.

**Note**

- If the [SIGNAL SEARCH] is set to [ON] when there is no signal input, press the <AUTO SETUP> button on the remote control or on the control panel, this function automatically detects the terminal to which signals are input and then switches.

**[BACK COLOR]**

Set the display of the projected screen when there is no signal input.

- 1) Press ▲▼ to select [BACK COLOR].
- 2) Press ◀▶ to switch the item.

- The items will switch each time you press the button.

[BLUE]	Displays the entire projection area in blue.
[BLACK]	Displays the entire projection area in black.
[DEFAULT LOGO]	Displays the Panasonic logo.
[USER LOGO]	Displays the image registered by the user.

**Note**

- To create/register the [USER LOGO] image, use “Logo Transfer Software” included in the supplied CD-ROM.
- If you do not register the image of the [USER LOGO], the projected image will be displayed in black even if the [BACK COLOR] is set to [USER LOGO].

**[WIDE MODE]**

Using this function when displays the incorrect signals input.

- 1) Press ▲▼ to select [WIDE MODE].
- 2) Press ◀▶ to switch the item.
  - The items will switch each time you press the button.

[AUTO]	Displays by judging the signal automatically. Set to this mode normally.
[ON]	When input the wide signal.
[OFF]	When input the 4:3 signal.

**[SXGA MODE]**

This function is used if the whole projected image is not displayed when SXGA signal is input.

- 1) Press ▲▼ to select [SXGA MODE].
- 2) Press ◀▶ to switch the item.
  - The items will switch each time you press the button.

[AUTO]	Displays by judging the signal automatically. Set to this mode normally.
[SXGA]	Switch the item to [SXGA] or [SXGA+] manually if the whole projected image is not displayed when SXGA signal is input.
[SXGA +]	

**[P-TIMER]**

Set and operate the presentation timer function.

**Setting the mode**

- 1) Press ▲▼ to select [P-TIMER].
- 2) Press the <ENTER> button.
  - The [P-TIMER] screen is displayed.
- 3) Press ▲▼ to select [MODE].
- 4) Press ◀▶ to switch the item.
  - The items will switch each time you press the button.

[COUNT UP]	Displays the elapsed time since the count was started.
[COUNT DOWN]	Displays the remaining time of the time set by [TIMER].

**Setting the countdown timer**

- 1) Press ▲▼ to select [P-TIMER].
- 2) Press the <ENTER> button.
  - The [P-TIMER] screen is displayed.
- 3) Press ▲▼ to select [TIMER].
- 4) Press ◀▶ to set the time.
  - The time can be set in 1-minute increments from 1 to 180 minutes.
  - The factory default value is 10 minutes.

**Note**

- [TIMER] is enabled when [MODE] is set to [COUNT DOWN].

**Using the presentation timer**

- 1) Press ▲▼ to select [P-TIMER].
- 2) Press the <ENTER> button.
  - The [P-TIMER] screen is displayed.
- 3) Press ▲▼ to select the item, and press the <ENTER> button.

[START]	The count is started.
[STOP]	The count is stopped.
[RESTART]	The count is resumed.
[RESET]	The count is reset.

- When [START] or [RESTART] is selected, the elapsed time or the remaining time is displayed at the bottom right of the projected image.
- When [STOP] is selected, the elapsed time or the remaining time when the count was stopped is displayed at the bottom right of the projected image.
- When [RESET] is selected, proceed to Step 4).

**4) Press the <MENU> button three times, then menu screen will disappear.**

- The P-TIMER function is cancelled.

**Note**

- Presentation timer operations are also possible by the <P-TIMER> button on the remote control. (➡ page 45)
- The security message set in the [SECURITY] menu → [TEXT DISPLAY] (➡ page 79) is not displayed when the elapsed time or remaining time is displayed.
- The elapsed time or remaining time is not displayed when the menu screen is displayed.
- The start time becomes "000:00" when [MODE] is set to [COUNT UP].
- When [MODE] is set to [COUNT DOWN], the start time becomes the value set at [TIMER].
- The time gauge turns clockwise when [COUNT UP] is set, and turns counterclockwise when [COUNT DOWN] is set.

**Ending the presentation timer**

- 1) Press ▲▼ to select [P-TIMER].**
- 2) Press the <ENTER> button.**
  - The [P-TIMER] screen is displayed.
- 3) Press ▲▼ to select [EXIT].**
- 4) Press the <ENTER> button.**

**[OTHER FUNCTIONS]**

You can perform some of the remote control button operations by using the sub-menu.

- 1) Press ▲▼ to select [OTHER FUNCTIONS].**
- 2) Press the <ENTER> button.**
  - The [OTHER FUNCTIONS] screen is displayed.
- 3) Press ▲▼ to select the item.**

[AUTO SETUP]	For details, refer to "Using the AUTO SETUP function". (➡ page 42)
[FREEZE]	The projected image is paused temporarily and the sound stopped regardless of the playback of the external equipment. To release this function, press the <RETURN> button or the <FREEZE> button on the remote control.
[AV MUTE]	Turn off audio and image when the projector is not used for a certain period of time. To release this function, press the <RETURN> button or the <AV MUTE> button on the remote control.
[DIGITAL ZOOM]	For details, refer to "Using the DIGITAL ZOOM function". (➡ page 44)

- 4) Press the <ENTER> button.**

# [PROJECTOR SETUP] menu

On the menu screen, select [PROJECTOR SETUP] from the main menu, and select an item from the submenu. Refer to "Navigating through the menu" (➔ page 48) for the operation of the menu screen.

- After selecting the item, press ▲▼◀▶ to set.

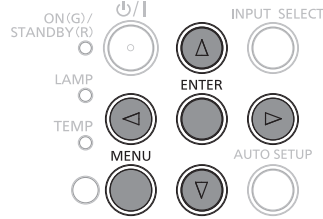
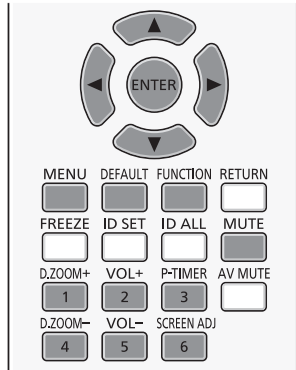

## [STATUS]

You can check the using status of the projector.

- 1) Press ▲▼ to select [STATUS].
- 2) Press the <ENTER> button.
  - The [STATUS] screen is displayed.

[SIGNAL]	[NAME]	Displays the name of input signal.	
	[FREQUENCY]	Displays the scanning frequency of input signal.	
[RUNTIME]*1	[PROJECTOR]	Displays the current usage time of projector.	
	[LAMP (ET-LAV400)*2]	[NORMAL]	Displays the lamp runtime when [LAMP POWER] is set to [NORMAL] by actual time.
		[ECO]	Displays the lamp runtime when [LAMP POWER] is set to [ECO] by actual time.
	[SERIAL NUMBER]	[PROJECTOR]	Displays the serial number of the projector.

\*1 The following conversion is required to calculate the rough estimate for lamp replacement.

Formula for lamp replacement time (rough estimate)	
$A \times 1 + B \times 5/7$	
• A :	Runtime which is displayed in [STATUS] screen → [RUNTIME] → [LAMP] → [NORMAL]
• B :	Runtime which is displayed in [STATUS] screen → [RUNTIME] → [LAMP] → [ECO]

\*2 The model No. of the optional lamp unit is subject to change without prior notice.

## [COMPUTER1 INPUT SETTING]

Set whether to use the <COMPUTER 1 IN> terminal.

- 1) Press ▲▼ to select [COMPUTER1 INPUT SETTING].
- 2) Press ◀▶ to switch the item.
  - The items will switch each time you press the button.

[RGB/YP <sub>B</sub> P <sub>R</sub> ]	Select when you want to input the RGB or YP <sub>B</sub> P <sub>R</sub> (YC <sub>B</sub> C <sub>R</sub> ) signal to <COMPUTER 1 IN> terminal.
[Y/C]	Select when you want to input a luminance signal and a color signal to <COMPUTER 1 IN> terminal.

## [COMPUTER2 SELECT]

Set whether to use the <COMPUTER 2 IN/1 OUT> terminal.

- 1) Press ▲▼ to select [COMPUTER2 SELECT].
- 2) Press ◀▶ to switch the item.
  - The items will switch each time you press the button.

[COMPUTER2 IN]	When input the computer signal.
[COMPUTER1 OUT]	Outputs the signal which has been input <COMPUTER 1 IN> terminal.

**Note**

- The [COMPUTER2 SELECT] will be unavailable when [COMPUTER2] is selected as input source.

**[PROJECTOR ID]**

The projector has an ID number setting function that can be used when multiple projectors are used side by side to enable simultaneous control or individual control via a single remote control.

1) Press ▲▼ to select [PROJECTOR ID].

2) Press the <ENTER> button.

- The [PROJECTOR ID] screen is displayed.

3) Press ▲▼ to select a projector ID.

- To select one item among [ALL] and [1] ~ [6].

[ALL]	Select when controlling projectors without specifying an ID number.
[1] ~ [6]	Select when specifying an ID number to control individual projector.

4) Press the <ENTER> button to set it.

- [PROJECTOR ID] is set.

**Note**

- To specify an ID number for individual control, the ID number of a remote control must match the ID number of the projector.
- When the ID number is set to [ALL], the projector will operate regardless of the ID number specified during remote control or computer control.  
If multiple projectors are set up side by side with ID set to [ALL], they cannot be controlled separately from the projectors with other ID numbers.
- Refer to “Setting the ID number of the remote control” (➔ page 45) for how to set the ID number on the remote control.

**[INITIAL START UP]**

Set the method of start up when the power cord plugged into the AC outlet.

1) Press ▲▼ to select [INITIAL START UP].

2) Press ◀▶ to switch the item.

- The items will switch each time you press the button.

[LAST MEMORY]	Starts in the condition that before disconnected the power cord or turn off the breaker.
[STANDBY]	Starts up in the standby mode.
[ON]	Starts the projection immediately.

**[PROJECTION METHOD]**

Set the projection method in accordance with the installation status of the projector.

Change the projection method if the screen display is upside down or inverted.

1) Press ▲▼ to select [PROJECTION METHOD].

2) Press ◀▶ to switch the projection method.

- The items will switch each time you press the button.

[FRONT/DESK]	When installing the projector on the desk, etc., in front of the screen.
[FRONT/CEILING]	When installing the projector in front of the screen with the Ceiling Mount Bracket (optional).
[REAR/DESK]	When installing the projector on the desk, etc., behind the screen (with a translucent screen).
[REAR/CEILING]	When installing the projector behind the screen (with a translucent screen) with the Ceiling Mount Bracket (optional).

**[LAMP POWER]**

Switch the brightness of the lamp according to the operating environment of the projector or the purpose.

1) Press ▲▼ to select [LAMP POWER].

2) Press ◀▶ to switch the item.

- The items will switch each time you press the button.



[NORMAL]	Select when high luminance is required.
[ECO]	Select when high luminance is not required.

**Note**

- Set it to [ECO] rather than [NORMAL] when you want to reduce power consumption, extend the life of lamp and reduce operation noise.

**[ECO MANAGEMENT]**

This function optimizes lamp power according to the operating status to reduce power consumption.

- 1) Press ▲▼ to select [ECO MANAGEMENT].
- 2) Press the <ENTER> button.
  - The [ECO MANAGEMENT] screen is displayed.
- 3) Press ▲▼ to select the item.

**Setting [AUTO POWER SAVE] in step 3)**

Set whether or not to enable the three functions, [AMBIENT LIGHT DETECTION], [SIGNAL DETECTION] and [AV MUTE DETECTION].

- 4) Press ◀▶ to switch the [AUTO POWER SAVE].

[OFF]	Disables the energy conservation setting.
[ON]	Enables the energy conservation setting.

- 5) Press ▲▼ to select one item.

[AMBIENT LIGHT DETECTION]	Adjusts the power of the lamp according to the brightness of the installation location.
[SIGNAL DETECTION]	Lowers the power of the lamp when there is no signal.
[AV MUTE DETECTION]	Lowers the power of the lamp when the [AV MUTE] is [ON].

- 6) Press ◀▶ to switch the item.
  - The items will switch each time you press the button.

[OFF]	Disables above setting.
[ON]	Enables above setting.

**Note**

- Lamp power cannot be reduced automatically in the following cases:
  - When the lamp lighting is just completed or the setting of [LAMP POWER] is just completed, etc..
- When [AUTO POWER SAVE] is set to [OFF], settings of [AMBIENT LIGHT DETECTION], [SIGNAL DETECTION], [AV MUTE DETECTION] are unavailable.
- When objects, etc. are placed around the luminance sensor on the top of the projector, [AMBIENT LIGHT DETECTION] may not function properly.

**Setting [POWER MANAGEMENT] in step 3)**

Set the operation as following if there is no signal input.

- 1) Press ▲▼ to select [POWER MANAGEMENT].
- 2) Press ◀▶ to switch the item.
  - The items will switch each time you press the button.

[SHUT DOWN]	The countdown timer is displayed after 30 seconds without input signal. The projection lamp is turned off and cooled down when reached the set time, then the projector enter into standby status.
[OFF]	Power management function is off.
[READY]	The countdown timer is displayed after 30 seconds without input signal. The projection lamp turns off and cools down when reaching the set time, meanwhile the projector is in the power management mode. The projection lamp will be turned on if the input signal is reconnected or any button is pressed.

**Setting [TIMER]**

The timer can be set to 5-120 minutes. The increment is 5 minutes.

- 1) Press ▲▼ to select [TIMER].
- 2) Press ◀▶ to set the timer (5-120 MIN.).
  - The time will switch each time you press the button.

### Setting [STANDBY MODE] in step 3)

Set the power consumption during standby.

1) Press ▲▼ to select [STANDBY MODE].

2) Press ◀▶ to switch the item.

- The items will switch each time you press the button.

[NORMAL]	Select this item to use the network function or the serial communication function during standby.
[ECO]	Select this item to reduce power consumption during standby.

#### Note

- If [STANDBY MODE] is set to [ECO], you cannot use network functions when the projector is standing by. Also, you cannot use some RS-232C protocol commands.
- When set to [ECO], it may take approx. 10 seconds longer before the projector starts projecting after the power is turned on, compared with when [NORMAL] is set.
- When set to [NORMAL], it may take approx. 1 minute to enable the network function after connecting the power cord.
- The setting of [STANDBY MODE] cannot be returned to the factory default even if the [PROJECTOR SETUP] menu → [INITIALIZE ALL] is executed. (▶ page 77)

### [EMULATE]

When controlling the projector on a computer via the <SERIAL IN> terminal, set use of control commands on a previously purchased Panasonic projector. This allows the control software for an existing Panasonic projector to be inherited and used.

1) Press ▲▼ to select [EMULATE].

2) Press the <ENTER> button.

- The [EMULATE] screen is displayed.

3) Press ▲▼ to select the desired item.

[DEFAULT]	VZ470 series, EZ590 series, EW650 series, EW550 series, EX620 series, EX520 series, EZ57 series, FZ570 series, FW530 series, FX500 series, RZ570 series, VW355N series, VX425N series, VW350 series, VX420 series, VZ575N series, VW535N series, VX605N series, VZ570 series, VW530 series, VX600 series, VX60, VX50, EZ580 series, EW640 series, EX610 series, EW540 series, EX510 series, VW345N series, VX415N series, VW340Z, VX410Z, VX42Z, VX406EA, VX46EA, EZ770 series, EW730 series, EX800 series, RZ475 series, RZ470 series, RW430 series, RZ370 series, RW330 series
[D3500]	D3500 series
[D4000]	D4000 series
[D/W5k SERIES]	D5700 series, DW5100 series, D5600 series, DW5000 series, D5500 series
[D/W/Z6k SERIES]	DZ770 series, DW740 series, DX810 series, DZ680 series, DW640 series, DX610 series, DW730 series, DX800 series, DZ6710 series, DZ6700 series, DW6300 series, D6000 series, D5000 series, DZ570 series, DW530 series, DX500 series
[L730 SERIES]	L730 series, L720 series, L520 series
[L780 SERIES]	L780 series, L750 series
[L735 SERIES]	L735 series
[L785 SERIES]	L785 series
[F/W SERIES]	FW430 series, FX400 series, FW300 series, F300 series, F200 series, FW100 series, F100 series
[LZ370]	LZ370 series
[LB/W SERIES]	LB3 series, LB2 series, LB1 series, ST10 series, LB90 series, LW80NT series, LB80 series, LB78 series, LB75 series
[VX500 SERIES]	VW435N series, VW440 series, VW430 series, VX505N series, VX510 series, VX500 series, VW330 series, VX400NT series, VX400 series, VX41 series
[EZ570 SERIES]	EZ570 series, EW630 series, EW530 series, EX600 series, EX500 series
[VW431D]	VW431D series

4) Press the <ENTER> button.

### [FUNCTION BUTTON]

The function assigned to the <FUNCTION> button of the remote control is displayed. You can also release the assigned setting.

#### Releasing assigned function to the <FUNCTION> button

1) Press ▲▼ to select [FUNCTION BUTTON].

- 2) Press the <ENTER> button.
  - The [FUNCTION BUTTON] screen is displayed.
- 3) Press the <ENTER> button.
- 4) When the confirmation message is displayed, select [OK] and press the <ENTER> button.

**Note**

- You can also cancel the assigned settings by displaying the on-screen menu, selecting the menu item to be canceled (main menu, submenu, or details menu), and then pressing the <FUNCTION> button for at least 3 seconds.

**[AUDIO SETTING]**

You can perform more detailed setting for Audio.

**Adjusting the volume**

- 1) Press ▲▼ to select [AUDIO SETTING].
- 2) Press the <ENTER> button.
  - The [AUDIO SETTING] screen is displayed.
- 3) Press ▲▼ to select [VOLUME].
- 4) Press ◀▶ to adjust the level.

Operation	Adjustment	Range
Press the ▶ button.	Increases the volume.	0 ~ +63
Press the ◀ button.	Decreases the volume.	

**Setting the mute**

- 1) Press ▲▼ to select [AUDIO SETTING].
- 2) Press the <ENTER> button.
  - The [AUDIO SETTING] screen is displayed.
- 3) Press ▲▼ to select [MUTE].
- 4) Press ◀▶ to switch the item.

[OFF]	Audio is output.
[ON]	Audio is not output.

**Setting the audio output during standby**

- 1) Press ▲▼ to select [AUDIO SETTING].
- 2) Press the <ENTER> button.
  - The [AUDIO SETTING] screen is displayed.
- 3) Press ▲▼ to select [IN STANDBY MODE].
- 4) Press ◀▶ to switch [IN STANDBY MODE].
  - The items will switch each time you press the button.

[OFF]	Disables audio output in the standby mode.
[ON]	Enables audio output in the standby mode when [STANDBY MODE] is set to [NORMAL]. At this time, press the <VOL - / VOL +> buttons on the remote control or ◀▶ buttons on the control panel to adjust the volume.

**Note**

- When [ECO MANAGEMENT] → [STANDBY MODE] is set to [ECO] (➔ page 74), even if [IN STANDBY MODE] is set to [ON], audio cannot be output during standby.

**Setting audio input selection**

Choose the audio input terminal for each input signal.

- 1) Press ▲▼ to select [AUDIO SETTING].

2) Press the <ENTER> button.

- The [AUDIO SETTING] screen is displayed.

3) Press ▲▼ to select one item of [AUDIO IN SELECT].

[COMPUTER1]	Set the audio output when [COMPUTER1] input is selected.
[COMPUTER2]	Set the audio output when [COMPUTER2] input is selected.
[VIDEO]	Set the audio output when [VIDEO] input is selected.
[HDMI1]	Set the audio output when [HDMI1] input is selected.
[HDMI2]	Set the audio output when [HDMI2] input is selected.

4) Press ◀▶ to switch the item.

- The sub items will switch each time you press the button.

[COMPUTER1]	Select one item among [AUDIO IN 1], [AUDIO IN 2] or [AUDIO IN 3].
[COMPUTER2]	Select one item among [AUDIO IN 1], [AUDIO IN 2] or [AUDIO IN 3].
[VIDEO]	Select one item among [AUDIO IN 1], [AUDIO IN 2] or [AUDIO IN 3].
[HDMI1]	Select one item among [HDMI1 AUDIO IN], [AUDIO IN 1], [AUDIO IN 2] or [AUDIO IN 3].
[HDMI2]	Select one item among [HDMI2 AUDIO IN], [AUDIO IN 1], [AUDIO IN 2] or [AUDIO IN 3].

**Note**

- When [MIC] is set to [ON], [AUDIO IN 2] cannot be selected.
- Even if [AUDIO IN 2] is selected, it will change to [AUDIO IN 1] automatically when [MIC] is set to [ON].

**Using MIC function**

1) Press ▲▼ to select [AUDIO SETTING].

2) Press the <ENTER> button.

- The [AUDIO SETTING] screen is displayed.

3) Press ▲▼ to select [MIC].

4) Press ◀▶ to switch the item.

- The items will switch each time you press the button.

[OFF]	Disables the MIC.
[ON]	<AUDIO IN 2> terminal switches to MIC input.

5) Press ▲▼ to select [MIC GAIN].

6) Press ◀▶ to adjust the level.

Operation	Adjustment	Range
Press the ▶ button.	Turns up the MIC mixing gain.	0 ~ +63
Press the ◀ button.	Turns down the MIC mixing gain.	

**Note**

- When [OFF] is selected in [MIC], the [MIC GAIN] is not available.
- If the [MIC] is set to [ON] when connecting audio signals to the <AUDIO IN 2 (MIC IN)> terminal, loud sound may be output suddenly depending on the setting value of [MIC GAIN].
- When [MIC] is set to [ON], no signal is input, AV MUTE function is on, FREEZE function is on or the POWER MANAGEMENT function is working, the audio of MIC will be output.

**[TEST PATTERN]**

Displays the test pattern built-in to the projector.

Settings of position, size, and other factors will not be reflected in test patterns. Make sure to display the input signal before performing various adjustments.

1) Press ▲▼ to select [TEST PATTERN].

2) Press the <ENTER> button.

- The test pattern with the [PATTERN CHANGE] individual adjustment screen is displayed.

3) Press ◀▶ to switch the item.

- The items will switch each time you press the button.  
All white → Color bars (vertical) → Color bars (horizontal) → White cross on the black background → Black cross on the white background → Cross hatch → All white →...
- When you press the <MENU> button or <RETURN> button, it will exit the test pattern and return to the sub menu of [PROJECT SETUP].

**Note**

- The initial setting is All white. The initial screen is Cross hatch if you have assigned it to the <FUNCTION> button.

**[FILTER COUNTER]**

This function is used to reset the filter use time and set the notification display.

1) Press ▲▼ to select [FILTER COUNTER].

2) Press the <ENTER> button.

- The [FILTER COUNTER] screen is displayed.

[FILTER COUNTER]	Displays the using time of the filter.
[TIMER]	Sets the timer when you want to display an alert message of filter replacement.
[FILTER COUNTER RESET]	Resets the filter counter.

**Setting [TIMER]**

1) Press ▲▼ to select [TIMER].

2) Press ◀▶ to switch the setting of the timer.

- The items will switch each time you press the button.  
[OFF] → [1000 H] → [2000 H] → [3000 H] → [4000 H] → [5000 H] → [6000 H] → [7000 H]

**[FILTER COUNTER RESET]**

1) Press ▲▼ to select [FILTER COUNTER RESET].

2) Press the <ENTER> button.

- The [FILTER COUNTER RESET] screen is displayed.

3) Press ◀▶ to select [OK] and then press the <ENTER> button.

**[INITIALIZE ALL]**

Return various setting values to their factory default settings.

1) Press ▲▼ to select [INITIALIZE ALL].

2) Press the <ENTER> button.

- The [INITIALIZE ALL] screen is displayed.

3) Press ◀▶ to select [OK] and then press the <ENTER> button.

- The [NOW INITIALIZING...] screen is displayed and then the [POWER OFF.] screen will be displayed.

4) Press the <ENTER> button.

- The operation of other buttons is disabled.
- The initial setting (display language) screen will be displayed when the projector is switched on the next time.

**Note**

- The projector will enter into the standby status to reflect the setting values when [INITIALIZE ALL] is executed.
- When [INITIALIZE ALL] is executed, [EMULATE] and the setting values of [NETWORK] cannot be returned to the factory default values. For details about the initialization of [NETWORK], please refer to [NETWORK] → [INITIALIZE]. (➡ page 82)

## [SECURITY] menu

On the menu screen, select [SECURITY] from the main menu, and select an item from the submenu. Refer to "Navigating through the menu" (➔ page 48) for the operation of the menu screen.

- When the projector is used for the first time Initial password:  
Press ▲▶▼◀▲▶▼◀ in order, and press the <ENTER> button.
- After selecting the item, press ▲▶▼◀ to set.

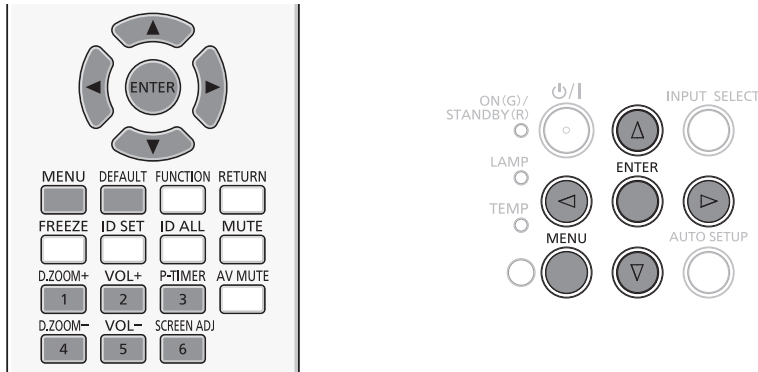

### Attention

- When you select the [SECURITY] menu and press the <ENTER> button, entering a password is required. Enter the preset password and then continue operations of the [SECURITY] menu.
- When the password has been changed previously, enter the changed password, and press the <ENTER> button.

### Note

- The entered password is displayed with "\*" mark on the screen.
- An error message is displayed on the screen when the entered password is incorrect. Re-enter the correct password.

## [PASSWORD]

The [PASSWORD] screen is displayed when the power is turned on, [INITIALIZE ALL] is executed or [INITIALIZE] in the [NETWORK] menu is executed. When the entered password is incorrect, the operation will be restricted to the power button <⏻/> on the control panel or on the remote control.

- 1) Press ▲▼ to select [PASSWORD].
- 2) Press ◀▶ to switch the item.
  - The items will switch each time you press the button.

[OFF]	Disables the security password entry.
[ON]	Enables the security password entry.

### Note

- The [PASSWORD] setting is set to [OFF] by the factory default.
- Change the password periodically that is hard to guess.
- The security password is enabled after setting [PASSWORD] to [ON], turning the power off and disconnecting the power plug from the power outlet.

## [PASSWORD CHANGE]

Change the security password.

- 1) Press ▲▼ to select [PASSWORD CHANGE].
- 2) Press the <ENTER> button.
  - The [PASSWORD CHANGE] screen is displayed.
- 3) Press ▲▶▼◀ or number buttons (<1>-<6>) to set the password.
  - Up to eight button operations can be set.
- 4) Press the <ENTER> button.
- 5) Re-enter the password for the confirmation.
- 6) Press the <ENTER> button.

**Note**

- The entered password is displayed with "\*" mark on the screen.
- An error message is displayed on the screen when the entered password is incorrect. Re-enter the correct password.
- If numbers have been used for the security password, the security password will need to be initialized again if the remote control is lost. Consult your dealer for the initialization method.

**[TEXT DISPLAY]**

Overlap the security message (text) over the projecting image.

- 1) Press ▲▼ to select [TEXT DISPLAY].
- 2) Press ◀▶ to switch the item.
  - The items will switch each time you press the button.

[OFF]	Disables the text display.
[ON]	Enables the text display.

**[TEXT CHANGE]**

Change the text displayed when the text display is enabled by selecting [ON] in [TEXT DISPLAY].

- 1) Press ▲▼ to select [TEXT CHANGE].
- 2) Press the <ENTER> button.
  - The [TEXT CHANGE] screen is displayed.
- 3) Press ▲▼◀▶ to select the text, and press the <ENTER> button to enter the text.
- 4) Press ▲▼◀▶ to select [OK], and press the <ENTER> button.
  - The text is changed.

**[MENU LOCK]**

Display the menu by the <MENU> button and set whether or not to enable menu operations.

- 1) Press ▲▼ to select [MENU LOCK].
- 2) Press ◀▶ to switch the item.
  - The items will switch each time you press the button.

[OFF]	Unlocks menu operations.
[ON]	Locks menu operations.

**Note**

- When the entered password is incorrect after setting [MENU LOCK] to [ON], the <MENU> button cannot be operated.
- [MENU LOCK] is set to [OFF] at the time of purchase or when [INITIALIZE ALL] is executed.
- When [MENU LOCK] is set to [ON] and then enter the password to release the lock, the unlock state is held until the projector enters the standby mode.

**[MENU LOCK PASSWORD]**

Change the menu lock password.

- 1) Press ▲▼ to select [MENU LOCK PASSWORD].
- 2) Press the <ENTER> button.
  - The [MENU LOCK PASSWORD] screen is displayed.
- 3) Press ▲▼◀▶ to select the text, and press the <ENTER> button to enter the text.
  - Up to 16 characters can be input.
- 4) Press ▲▼◀▶ to select [OK], and press the <ENTER> button.
  - To cancel, select [CANCEL].

**Attention**

- The initial password is "AAAA" at the time of purchase or when [INITIALIZE ALL] is executed.
- Change the password periodically that is hard to guess.

**[CONTROL DEVICE SETUP]**

Enable/disable the button operations on the control panel and the remote control.

1) Press ▲▼ to select [CONTROL DEVICE SETUP].

2) Press the <ENTER> button.

- The [CONTROL DEVICE SETUP] screen is displayed.

3) Press ▲▼ to select one item between [CONTROL PANEL] and [REMOTE CONTROLLER].

[CONTROL PANEL]	You can set the limitation on the control from the control panel.
[REMOTE CONTROLLER]	You can set the limitation on the control from the remote control.

4) Press ◀▶ to switch between [ENABLE] and [DISABLE].

- You can set the limitation on the control from the control panel or the remote control.

[ENABLE]	Enable the button operations.
[DISABLE]	Disable the button operations.

- A confirmation screen will be displayed when you change [ENABLE] to [DISABLE], then proceed to Step 5).

5) Press ◀▶ to select [OK], and then press the <ENTER> button.

**Note**

- When a button operation is performed on the device set to [DISABLE], the [PASSWORD] screen is displayed. To continue operations, enter the security password.
- The [PASSWORD] screen will disappear when there is no operation for approx. 10 seconds.
- If the operations of both [CONTROL PANEL] and [REMOTE CONTROLLER] are set to [DISABLE], the projector cannot be turned off (cannot enter standby).
- Even when you set button operations on the remote control to be disabled, operations of the <ID ALL> and <ID SET> buttons on the remote control are enabled.



## [NETWORK] menu

On the menu screen, select [NETWORK] from the main menu, and select an item from the submenu. Refer to "Navigating through the menu" (➔ page 48) for the operation of the menu screen.

- After selecting the item, press ▲▼◀▶ to set.

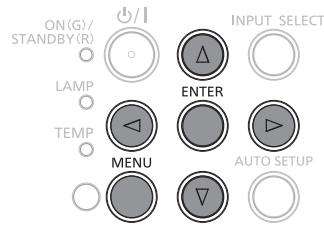
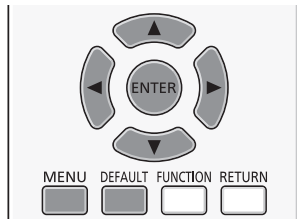

### [WIRED LAN]

You can make detailed wired LAN settings.

- 1) Press ▲▼ to select [WIRED LAN].
- 2) Press the <ENTER> button.
  - The [WIRED DETAILED SETUP] screen is displayed.
- 3) Press ▲▼ to select an item, and change the setting according to the instructions.

[DHCP]	[ON]: If a DHCP server exists in the network to which the projector is connected, the IP address will automatically be acquired. [OFF]: If a DHCP server does not exist in the network to which the projector is connected, additionally set [IP ADDRESS], [SUBNET MASK] and [DEFAULT GATEWAY].
[IP ADDRESS]	Enter the IP address if DHCP server is not used.
[SUBNET MASK]	Enter the subnet mask if DHCP server is not used.
[DEFAULT GATEWAY]	Enter the gateway address if DHCP server is not used.
[DNS1]	Enter the DNS server address if DHCP server is not used.
[DNS2]	Enter the alternate DNS server address if DHCP server is not used.

- 4) Press ▲▼ to select [OK], and press the <ENTER> button.

#### ■ Default wired LAN settings

- The following settings are set before the projector leaves the factory.

[DHCP]	OFF
[IP ADDRESS]	192.168.10.100
[SUBNET MASK]	255.255.255.0
[DEFAULT GATEWAY]	192.168.10.1
[DNS1] / [DNS2]	NULL

#### Note

- Before using the DHCP server, make sure the DHCP server is already functioning.
- Consult your network administrator regarding the IP ADDRESS, SUBNET MASK, and DEFAULT GATEWAY.

### [NAME CHANGE]

You can change the projector name, for example, when using the DHCP server.

- 1) Press ▲▼ to select [NAME CHANGE].
- 2) Press the <ENTER> button.
  - The [NAME CHANGE] screen is displayed.
- 3) Select characters with the ▲▼◀▶ buttons and press the <ENTER> button to enter the projector name.
  - Select [ALL DELETE] to delete all the entered characters, or press the <DEFAULT> button on the remote control to delete a character on the cursor in the entry field.
- 4) Select [OK] with the ▲▼ buttons and press the <ENTER> button.
  - To cancel the change of the name, select [CANCEL] and press the <ENTER> button.

**Note**

- [Name □□□□] (□□□□ is 4-digit number) is set before the projector leaves the factory.

**[NETWORK CONTROL]**

Set when you want to control the projector from a computer connected to the network.

1) Press ▲▼ to select [NETWORK CONTROL].

2) Press ◀▶ to switch the item.

- The items will switch each time you press the button.

[OFF]	This function is disabled.
[ON]	This function is enabled. WEB control, PJLink control, the command control of the LAN are enabled.

**[AMX D. D.]**

Set to [ON] to control with the controller of AMX Corporation.

Setting this function to [ON] enables detection through “AMX Device Discovery”. For details, refer to the website of AMX Corporation.

URL <http://www.amx.com/>

1) Press ▲▼ to select [AMX D. D.].

2) Press ◀▶ to switch the item.

- The items will switch each time you press the button.

[OFF]	This function is disabled.
[ON]	This function is enabled.

**[Crestron Connected(TM)]**

Set to [ON] to control with Crestron Connected™ of Crestron Electronics, Inc.

1) Press ▲▼ to select [Crestron Connected(TM)].

2) Press ◀▶ to switch the item.

- The items will switch each time you press the button.

[OFF]	This function is disabled.
[ON]	This function is enabled.

**[STATUS]**

Displays the current network status.

1) Press ▲▼ to select [STATUS].

2) Press the <ENTER> button.

- The [STATUS] screen is displayed.

[DHCP]	Displays the usage state of the DHCP server.
[IP ADDRESS]	Displays the IP address.
[SUBNET MASK]	Displays the subnet mask.
[DEFAULT GATEWAY]	Displays the default gateway.
[DNS1]	Displays the address of the primary DNS server.
[DNS2]	Displays the address of the secondary DNS server.
[MAC ADDRESS]	Displays the MAC address.

**[INITIALIZE]**

This function is used to return various setting values of [NETWORK] to the factory default value.

1) Press ▲▼ to select [INITIALIZE].

2) Press the <ENTER> button.

- The [INITIALIZE] screen is displayed.

3) Press ◀▶ to select [OK] and then press the <ENTER> button.

## Network connections

The projector has a network function, and the following operations are available from the computer using the web browser control.

- Setting and adjustment of the projector.
- Display of the projector status.
- Transmission of an E-mail message when there is a problem with the projector.

The projector supports "Crestron Connected™", and the following application software of Crestron Electronics, Inc. can be used.

- RoomView Express
- Crestron Fusion
- RoomView Server Edition

### Note

- "Crestron Connected™" is a system developed by Crestron Electronics, Inc. which collectively manage and control multiple system devices connected via the network, from a computer. This projector supports "Crestron Connected™".
- For details of "Crestron Connected™", please refer to the website of the Crestron Electronics, Inc.. (Only in English)  
<https://www.crestron.com/>  
For the download of "RoomView Express", please refer to the website of Crestron Electronics, Inc.. (Only in English)  
<https://www.crestron.com/resources/get-roomview>

## Computer that can be used

In order to use the Web control function, a Web browser is required. Confirm that the Web browser can be used beforehand.

OS	Compatible web browser
Windows	Internet Explorer 7.0 / 8.0 / 9.0 / 10.0 / 11.0
Mac OS	Safari 4.0 / 5.0 / 6.0 / 7.0

### Note

- Communication with an E-mail server is required to use the E-mail function. Confirm that the E-mail can be used beforehand.

## Connecting with Wired LAN

### Example of a normal network connection

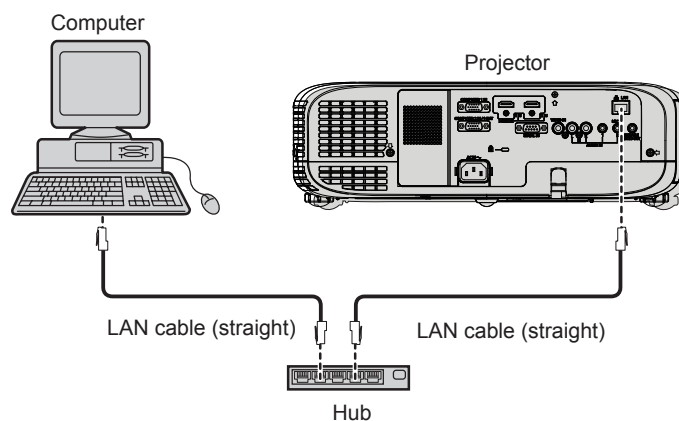

### Attention

- When a LAN cable is directly connected to the projector, the network connection must be made indoors.

### Note

- A LAN cable is required to use the wired LAN function.
- Use shielded LAN cable (STP cable) that is compatible with category 5 or above.
- Use a LAN cable with length of 100 m or shorter.

## Projector settings

- 1) Use the LAN cable to connect the projector with computer.
- 2) Turn on the projector.
- 3) Press the <MENU> button to display the [NETWORK] menu, and then select [WIRED LAN], and press the <ENTER> button.
- 4) Set the detailed setup of [WIRED LAN].
  - For details, refer to "WIRED LAN". (➔ page 81)

**Note**

- Please confirm with your network administrator before you connect to an existing network.
- The following settings are set before the projector leaves the factory.

[DHCP]	OFF
[IP ADDRESS]	192.168.10.100
[SUBNET MASK]	255.255.255.0
[DEFAULT GATEWAY]	192.168.10.1
[DNS1] / [DNS2]	NULL

**Computer setting**

- 1) Turn on the computer.
- 2) Make the network setting according to your system administrator.
  - If the projector settings are the default settings, the computer can be used with the following network settings.

[IP ADDRESS]	192.168.10.101
[SUBNET MASK]	255.255.255.0
[DEFAULT GATEWAY]	192.168.10.1

**Accessing from the web browser**

- 1) Start up the web browser on the computer.
- 2) Enter the IP address set on the projector into the URL entry field of the web browser.
- 3) Enter the user name and the password.
  - The factory default setting of the user name is user1 (user rights)/admin1 (administrator rights) and the password is panasonic (lower case).

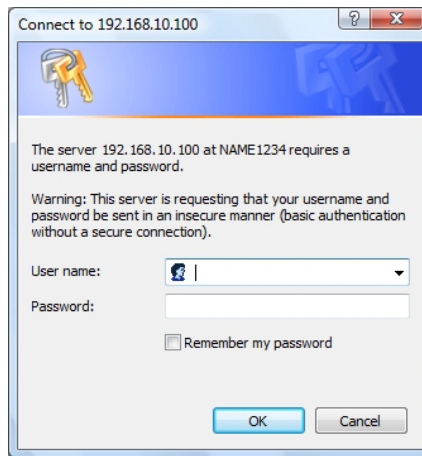

- 4) Click [OK].
  - The [Projector status] page is displayed.

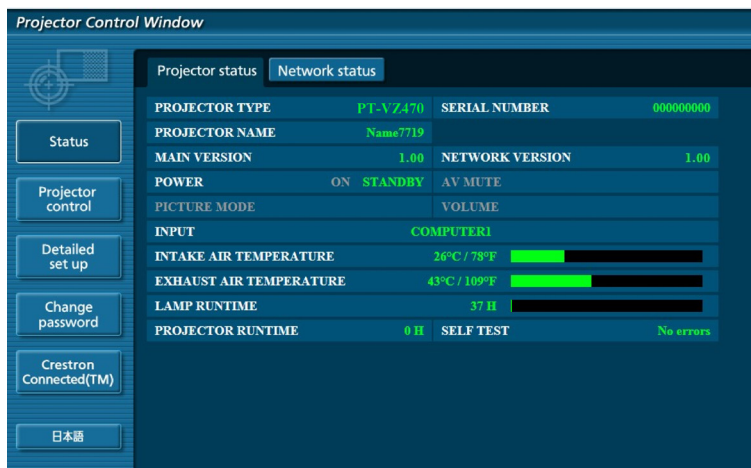

Note

- If you use a web browser to control the projector, set [NETWORK CONTROL] to [ON] in [NETWORK]. (➔ page 82)
- Do not perform setting or control simultaneously by starting up multiple web browsers. Do not set or control the projector from multiple computers.
- Change the password first. (➔ page 93)
- The administrator rights allow use of all functions. The user rights allow use of [Projector status] (➔ page 85), confirmation of the error information page (➔ page 86), [Network status] (➔ page 87), [Basic control] (➔ page 87), [Advanced control] (➔ page 87), and [Change password] (➔ page 93) only.
- Access will be locked for few minutes when an incorrect password is entered three times consecutively.
- Some items on the projector setting page use the Javascript function of the web browser. The projector may not be able to be controlled properly if it is set with a browser that does not have this function enabled.
- If the screen for the web control is not displayed, consult your network administrator.
- While updating the screen for the web control, the screen may become white for a moment, but it is not a malfunction.

Description of each item

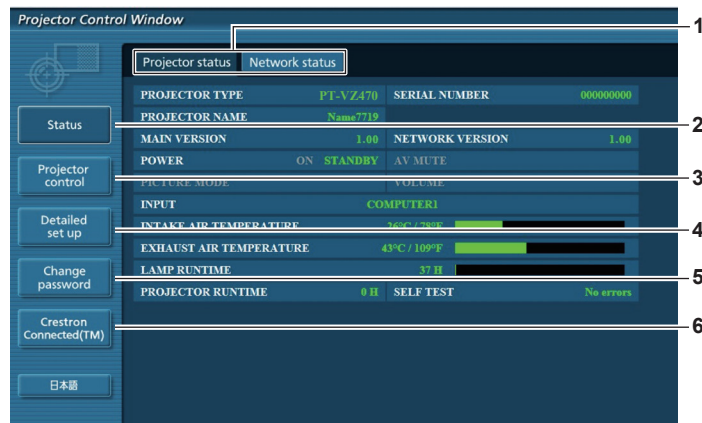

- 1 **Page tab**  
Switches pages by clicking this item.
- 2 **[Status]**  
The status of the projector is displayed by clicking this item.
- 3 **[Projector control]**  
The [Projector control] page is displayed by clicking this item.
- 4 **[Detailed set up]**  
The [Detailed set up] page is displayed by clicking this item.
- 5 **[Change password]**  
The [Change password] page is displayed by clicking this item.
- 6 **[Crestron Connected(TM)]**  
The control page of Crestron Connected™ is displayed by clicking this item.

[Projector status] page

Click [Status] → [Projector status].  
Display the status of the projector for the following items.

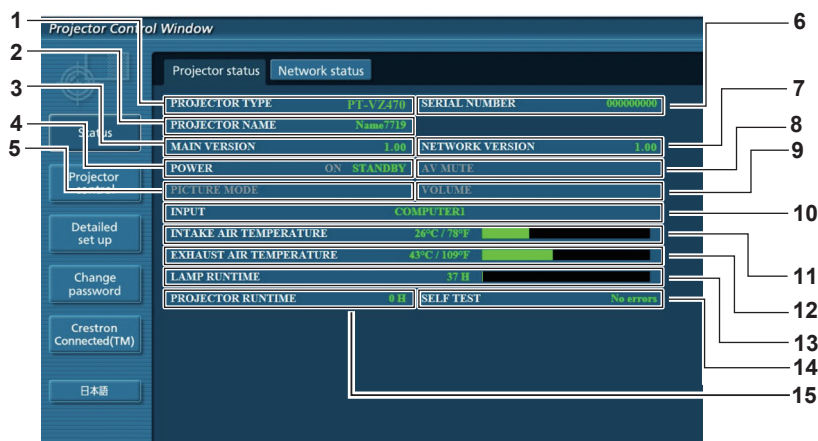

- 1 **[PROJECTOR TYPE]**  
Displays the type of the projector.
- 2 **[PROJECTOR NAME]**  
Displays the name set in the projector.
- 3 **[MAIN VERSION]**  
Displays the firmware version of the projector.
- 4 **[POWER]**  
Displays the status of the power.
- 5 **[PICTURE MODE]**  
Displays the status of the picture mode.
- 6 **[SERIAL NUMBER]**  
Displays the serial number of the projector.
- 7 **[NETWORK VERSION]**  
Displays the version of firmware of the network.

- 8 **[AV MUTE]**  
Displays the AV mute status.
- 9 **[VOLUME]**  
Displays the volume status.
- 10 **[INPUT]**  
Displays the status of the selected input.
- 11 **[INTAKE AIR TEMPERATURE]**  
Displays the status of the air intake temperature of the projector.
- 12 **[EXHAUST AIR TEMPERATURE]**  
Displays the status of the exhaust air temperature of the projector.
- 13 **[LAMP RUNTIME]**  
Displays the runtime of the lamp (converted value).
- 14 **[SELF TEST]**  
Displays the self diagnostics information.
- 15 **[PROJECTOR RUNTIME]**  
Displays the runtime of the projector.

### Error information page

When [Error (Detail)] or [Warning (Detail)] is displayed in the self-diagnosis display of the [Projector status] screen, click it to display the error/warning details.

- The projector may go into the standby status to protect the projector depending on the contents of the error.



#### 1 Self-diagnosis result display

Displays the item check results.

**[OK]**: Indicates that operation is normal.

**[FAILED]**: Indicates that there is a problem.

**[WARNING]**: Indicates that there is a warning.

#### ■ [FAILED] items displayed when a problem occurs

Parameter	Description
[FAN]	Trouble has occurred in the fan or its drive circuit. Consult your dealer.
[FAN(INTAKE1)]	Trouble has occurred in the intake fan 1.
[FAN(INTAKE2)]	Trouble has occurred in the intake fan 2.
[FAN(INTAKE3)]	Trouble has occurred in the intake fan 3.
[FAN(INTAKE4)]	Trouble has occurred in the intake fan 4.
[FAN(EXHAUST)]	Trouble has occurred in the exhaust fan.
[FAN(LAMP)]	Trouble has occurred in the lamp cooling fan.
[INTAKE AIR TEMPERATURE]	The air intake temperature is too high. The projector may be used in an operating environment where the temperature is high, such as near a heating appliance.
[EXHAUST AIR TEMPERATURE]	The exhaust air temperature is high. The air exhaust port may be blocked.
[LAMP REMAIN TIME]	The lamp runtime has exceeded the prescribed cumulative time, and it is now time to replace the lamp.
[LAMP STATUS]	The lamp has failed to light. Wait a short while for the lamp to cool off, and then turn on the power.
[APERTURE (CONTRAST-SHUTTER)]	Trouble has occurred in the contrast shutter circuitry. Consult your dealer.
[AIR FILTER]	There is too much dust accumulated in the air filter unit. Turn off the projector and unplug the power plug from the wall outlet, then replace the air filter unit.

**[Network status] page**

Click [Status] → [Network status].

The current network setting status is displayed.

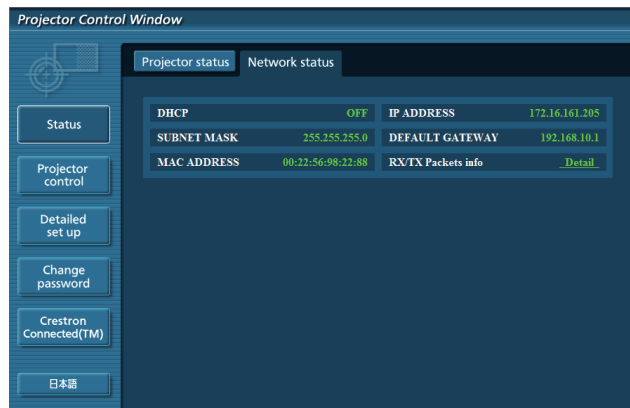

**[Basic control] page**

Click [Projector control] → [Basic control].

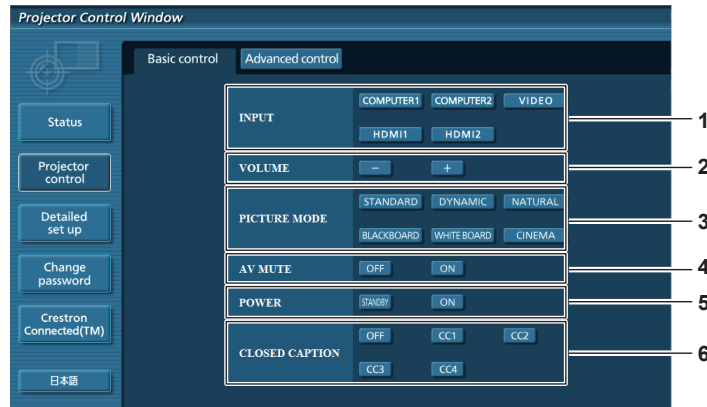

- 1 **[INPUT]**  
Switches the input signal.
- 2 **[VOLUME]**  
Adjusts the volume level.
- 3 **[PICTURE MODE]**  
Switches the picture mode.
- 4 **[AV MUTE]**  
Switches between AV mute on/off.
- 5 **[POWER]**  
Turns on/off the power.
- 6 **[CLOSED CAPTION]**  
Switches the closed caption mode.

**[Advanced control] page**

Click [Projector control] → [Advanced control].



- 1 **[POSITION]**  
Adjusts the position of image and the keystone correction.
- 2 **[PICTURE]**  
Adjusts the items of image.

**[Network config] page**

Click [Detailed set up] → [Network config].

- 1) Click [Network config].
  - The [CAUTION!] screen is displayed.

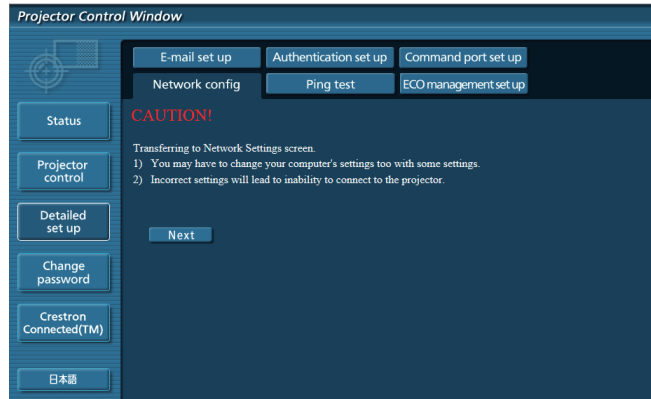

- 2) Select the item which you want to change the setting, then click [Next].
  - The current setting is displayed.
- 3) Click [Change] button.
  - The setting change screen is displayed.

**Wired LAN**

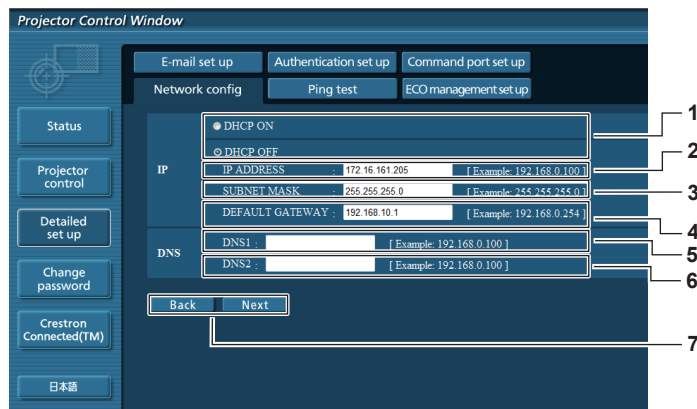

- 1 **[DHCP ON], [DHCP OFF]**  
To enable the DHCP client function, set to [DHCP ON].
- 2 **[IP ADDRESS]**  
Enter the IP address when not using a DHCP server.
- 3 **[SUBNET MASK]**  
Enter the subnet mask when not using a DHCP server.
- 4 **[DEFAULT GATEWAY]**  
Enter the default gateway address when not using a DHCP server.
- 5 **[DNS1]**  
Enter the DNS1 server address.  
Permissible characters for the entry of DNS1 server address (primary):  
Numbers (0 - 9), period (.)  
(Example: 192.168.0.253)
- 6 **[DNS2]**  
Enter the DNS2 server address.  
Permissible characters for the entry of DNS2 server address (secondary):  
Numbers (0 - 9), period (.)  
(Example: 192.168.0.254)
- 7 **[Back], [Next]**  
Click the [Back] button to return to the original screen.  
The current settings are displayed by pressing the [Next] button.  
Click the [Submit] button to update the settings.

**Note**

- When you use the “Forward” and “Back” functions of your browser, a warning message “Page has Expired” may appear. In that case, click [Network config] again since the following operation will not be guaranteed.
- Changing LAN settings while connected to the LAN may cause the connection to cut out.



[Ping test] page

Check whether the network is connected to the mail server, POP server, DNS server, etc.  
Click [Detailed set up] → [Ping test].



```
PING 192.168.10.218 (192.168.10.218): 56 data bytes
64 bytes from 192.168.10.218: seq=0 ttl=128 time=1.228 ms
64 bytes from 192.168.10.218: seq=1 ttl=128 time=0.942 ms
64 bytes from 192.168.10.218: seq=2 ttl=128 time=0.854 ms
64 bytes from 192.168.10.218: seq=3 ttl=128 time=0.962 ms

--- 192.168.10.218 ping statistics ---
4 packets transmitted, 4 packets received, 0% packet loss
round-trip min/avg/max = 0.854/0.996/1.228 ms
```

```
PING 192.168.10.217 (192.168.10.217): 56 data bytes

--- 192.168.10.217 ping statistics ---
4 packets transmitted, 0 packets received, 100% packet loss
```

- 1 [Input IP address]  
Enter the IP address of the server to be tested.
- 2 [Submit]  
Executes the connection test.
- 3 Example of display when the connection has succeeded
- 4 Example of display when the connection has failed

[E-mail set up] page

When there is a problem or the runtime of a lamp reaches a set value, an E-mail can be sent to preset E-mail addresses (up to two addresses).

Click [Detailed set up] → [E-mail set up].

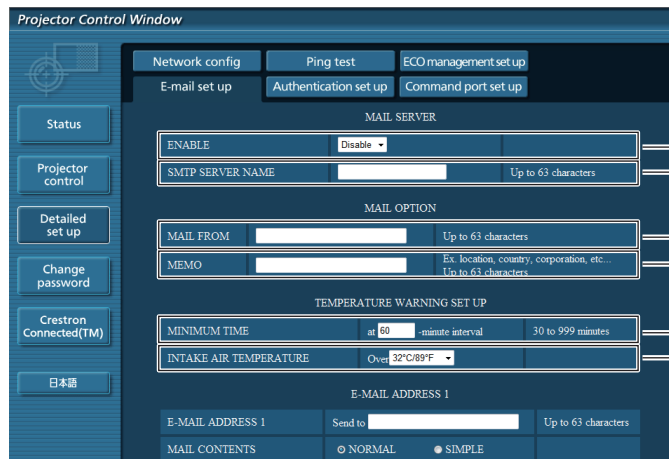

- 1 [ENABLE]  
Select [Enable] to use the E-mail function.
- 2 [SMTP SERVER NAME]  
Enter the IP address or the server name of the E-mail server (SMTP). To enter the server name, the DNS server needs to be set up.
- 3 [MAIL FROM]  
Enter the E-mail address of the projector. (Up to 63 characters in single byte)
- 4 [MEMO]  
Enter information such as the location of the projector that notifies the sender of the E-mail. (Up to 63 characters in single byte)
- 5 [MINIMUM TIME]  
Change the minimum interval for the temperature warning E-mail. The default value is 60 minutes. In this case, another E-mail will not be sent for 60 minutes after sending the temperature warning E-mail even if it reaches the warning temperature.
- 6 [INTAKE AIR TEMPERATURE]  
Change the temperature setting for the temperature warning mail. A temperature warning E-mail is sent when the temperature exceeds this value.

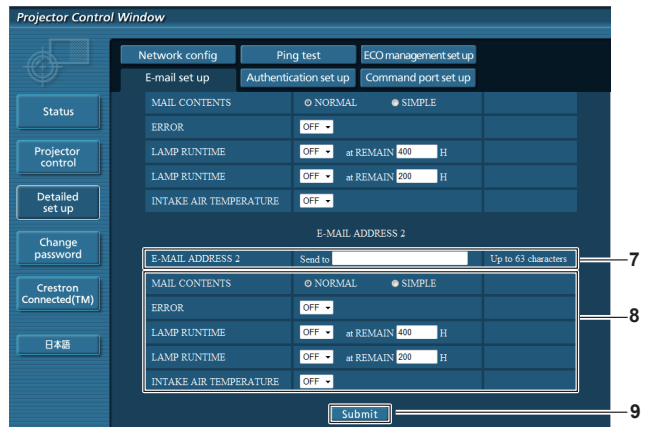
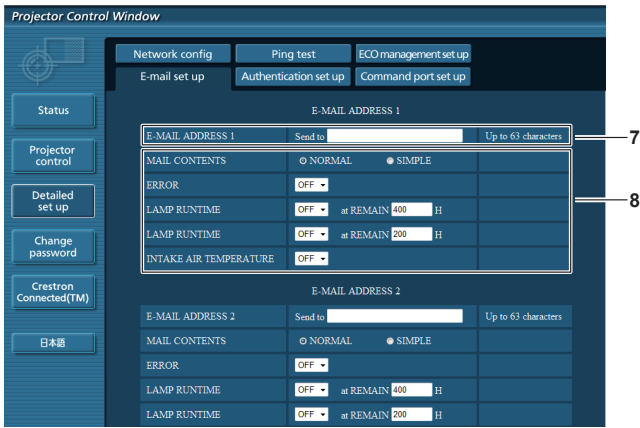

- 7 **[E-MAIL ADDRESS 1]/[E-MAIL ADDRESS 2]**  
Enter the E-mail address to be sent. Leave [E-MAIL ADDRESS 2] blank when two E-mail addresses are not to be used.
- 8 **Settings of the conditions to send E-mail**  
Select the conditions to send E-mail.  
**[MAIL CONTENTS]:**  
Select either [NORMAL] or [SIMPLE].  
**[ERROR]:**  
Send an E-mail when an error occurred in the self-diagnosis.

- [LAMP RUNTIME]:**  
An E-mail message is sent when the remaining lamp on time for the lamp has reached the value set at the right field.
- [INTAKE AIR TEMPERATURE]:**  
Send an E-mail when the air intake temperature has reached the value set at the above field.
- 9 **[Submit]**  
Update the settings.

**[Authentication set up] page**

Set the authentication items when POP authentication or SMTP authentication is necessary to send an E-mail. Click [Detailed set up] → [Authentication set up].

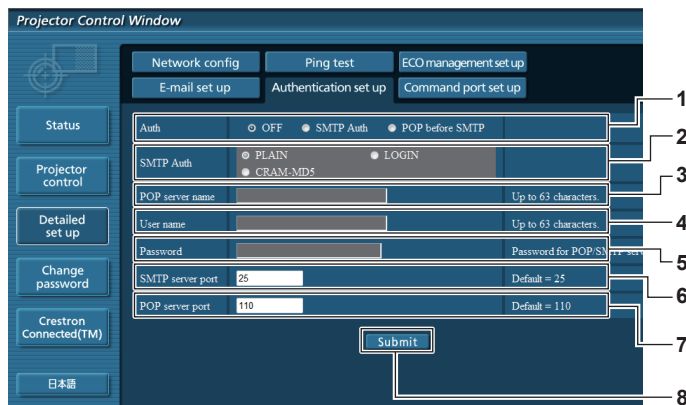

- 1 **[Auth]**  
Select the authentication method specified by your Internet service provider.
- 2 **[SMTP Auth]**  
Set when the SMTP authentication is selected.
- 3 **[POP server name]**  
Enter the POP server name.  
Allowed characters:  
Alphanumerics (A - Z, a - z, 0 - 9)  
Minus sign (-) and period (.)
- 4 **[User name]**  
Enter the user name for the POP server or the SMTP server.

- 5 **[Password]**  
Enter the password for the POP server or the SMTP server.
- 6 **[SMTP server port]**  
Enter the port number of the SMTP server. (Normally 25)
- 7 **[POP server port]**  
Enter the port number of the POP server. (Normally 110)
- 8 **[Submit]**  
Update the settings.

## Contents of mail sent

### Example of E-mail sent when E-mail is set

Mail with the contents shown below is sent when the e-mail settings have been established.

```

=== Panasonic projector report(CONFIGURE) ===
Projector Type      : PT-VZ470
Serial No          : SH1234567
----- E-mail setup data -----
TEMPERATURE WARNING SETUP
MINIMUM TIME       at [ 60] minutes interval
INTAKE AIR TEMPERATURE Over [ 32degC / 89degF ]

ERROR              [ OFF ]
LAMP RUNTIME       [ OFF ]   at REMAIN [ 400] H
LAMP RUNTIME       [ OFF ]   at REMAIN [ 200] H
INTAKE AIR TEMPERATURE [ OFF ]

----- check system -----
FAN                [ OK ]
INTAKE AIR TEMPERATURE [ OK ]
EXHAUST AIR TEMPERATURE [ OK ]
LAMP REMAIN TIME    [ OK ]
LAMP STATUS         [ OK ]
APERTURE (CONTRAST-SHUTTER) [ OK ]
AIR FILTER          [ OK ]
(Error code 00 00 00 00 00 00 00 00)

Intake air temperature : 31 degC / 87 degF
Exhaust air temperature : 37 degC / 98 degF

PROJECTOR RUNTIME      800 H

LAMP ECO               500 H
LAMP NORMAL            100 H
LAMP REMAIN            3400 H

----- Current status -----
MAIN VERSION          1.00
NETWORK VERSION       1.00
SUB VERSION           1.00
LAMP STATUS           LAMP=ON
INPUT                 RGB
SIGNAL NAME           XGA6
SIGNAL FREQUENCY      0.00kHz / 0.00Hz

----- Wired Network configuration -----
DHCP Client          OFF
IP address           192.168.10.100
MAC address          04:20:9A:00:00:00

----- Memo -----

```

**Example of E-mail sent for an error**

Mail with the contents shown below is sent when an error has occurred.

```

=== Panasonic projector report(ERROR) ===
Projector Type       : PT-VZ470
Serial No           : SH1234567
----- check system -----
FAN                 [ OK ]
INTAKE AIR TEMPERATURE [ OK ]
EXHAUST AIR TEMPERATURE [ OK ]
LAMP REMAIN TIME    [ OK ]
LAMP STATUS         [ OK ]
APERTURE (CONTRAST-SHUTTER) [ OK ]
AIR FILTER          [ FAILED ]
(Error code 00 40 00 00 00 00 00 08)

Intake air temperature : 31 degC / 87 degF
Exhaust air temperature : 37 degC / 98 degF

PROJECTOR RUNTIME      800 H

LAMP ECO              500 H
LAMP NORMAL           100 H
LAMP REMAIN           3400 H

----- Current status -----
MAIN VERSION          1.00
NETWORK VERSION       1.00
SUB VERSION           1.00
LAMP STATUS           LAMP=OFF
INPUT                 RGB

----- Wired Network configuration -----
DHCP Client           OFF
IP address            192.168.10.100
MAC address           04:20:9A:00:00:00

----- Memo -----
    
```

**[Command port set up] page**

Set the port number used for command control.  
 Click [Detailed set up] → [Command port set up].

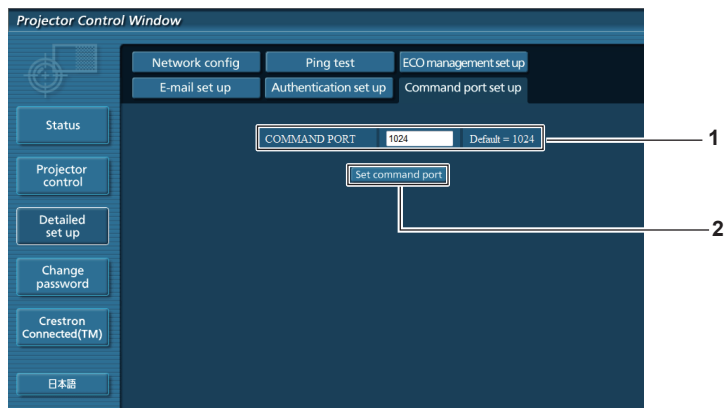

**1 [COMMAND PORT]**  
 Set the port number used for command control.

**2 [Set command port]**  
 Update the settings.

**[ECO management set up] page**

You can make settings for the ECO management function of the projector.  
Click [Detailed set up] → [ECO management set up].

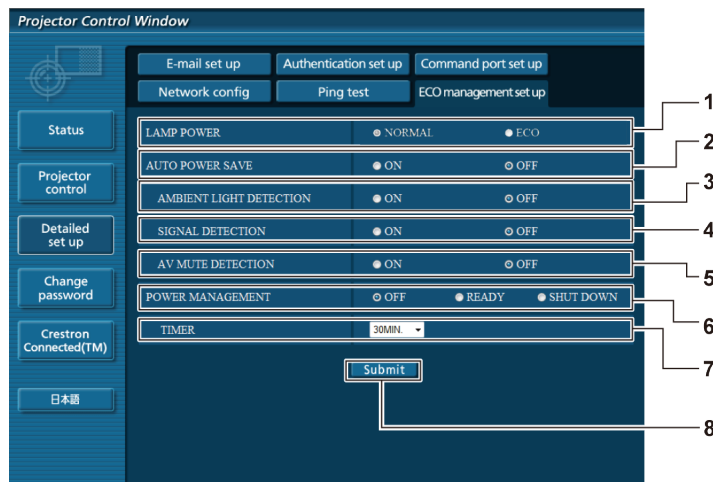

- |   |   |
|---|---|
| <p><b>1 [LAMP POWER]</b><br/>Selects the [LAMP POWER] setting.</p> <p><b>2 [AUTO POWER SAVE]</b><br/>Select [ON] to set [AMBIENT LIGHT DETECTION], [SIGNAL DETECTION], and [AV MUTE DETECTION].</p> <p><b>3 [AMBIENT LIGHT DETECTION]</b><br/>Enable ([ON])/disable ([OFF]) the ambient light detection function.</p> <p><b>4 [SIGNAL DETECTION]</b><br/>Enable ([ON])/disable ([OFF]) the signal detection function.</p> | <p><b>5 [AV MUTE DETECTION]</b><br/>Enable ([ON])/disable ([OFF]) the AV mute detection function.</p> <p><b>6 [POWER MANAGEMENT]</b><br/>Select the power consumption mode.</p> <p><b>7 [TIMER]</b><br/>Select the time that the lamp is turned off when the POWER MANAGEMENT function is using.</p> <p><b>8 [Submit]</b><br/>Update the setting.</p> |
|---|---|

**Note**

- For detailed description of each setting item, refer to the [PROJECTOR SETUP] menu of the projector → [ECO MANAGEMENT]. (➡ page 73)

**[Change password] page**

Click [Change password].

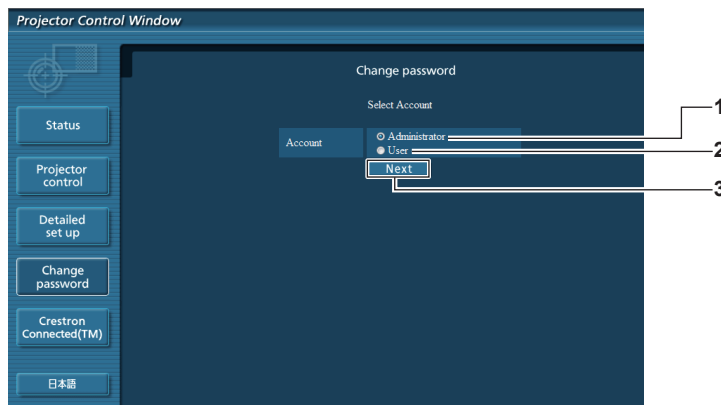

- |   |  |
|---|--|
| <p><b>1 [Administrator]</b><br/>Used to change the setting of [Administrator].</p> <p><b>2 [User]</b><br/>Used to change the setting of [User].</p> | <p><b>3 [Next]</b><br/>Used to change the setting of the password.</p> |
|---|--|

[Administrator] account

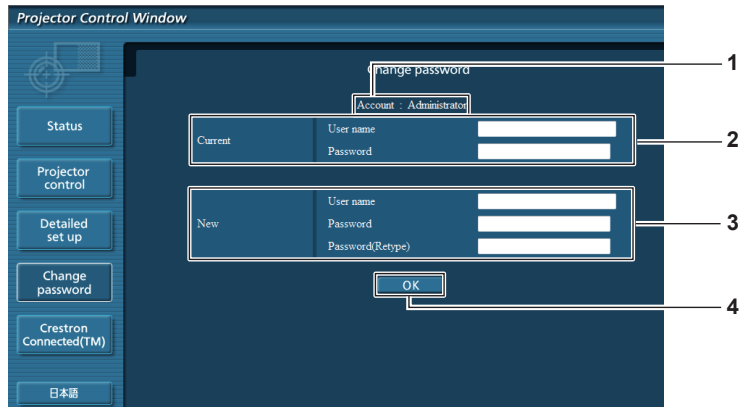

1 [Account]

Displays the account to change.

2 [Current]

[User name]:

Enter the user name before the change.

[Password]:

Enter the current password.

3 [New]

[User name]:

Enter the desired new user name.

(Up to 16 characters in single byte)

[Password]:

Enter the desired new password.

(Up to 16 characters in single byte)

[Password (Retype)]:

Enter the desired new password again.

4 [OK]

Determines the change of password.

[User] account

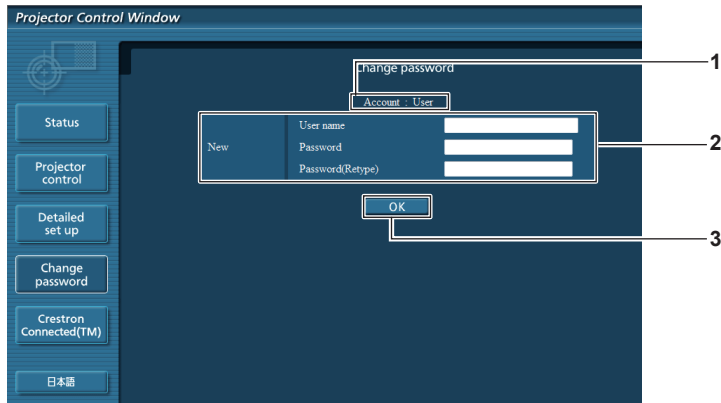

1 [Account]

Displays the account to change.

2 [New]

[User name]:

Enter the desired new user name.

(Up to 16 characters in single byte)

[Password]:

Enter the desired new password. (Up to 16 characters

in single byte)

[Password (Retype)]:

Enter the desired new password again.

3 [OK]

Determines the change of password.

**[Change password] (For user rights)**

Only the change of password is enabled under the user rights.

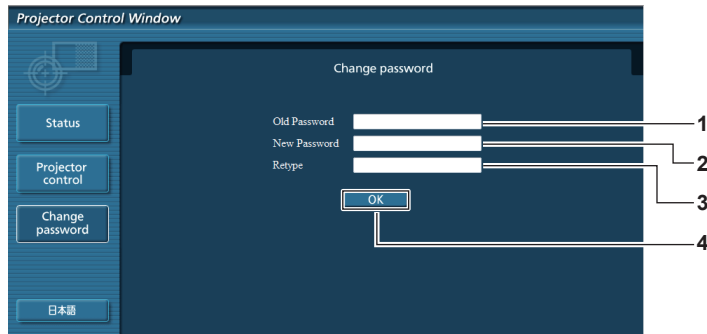

**1 [Old Password]**

Enter the current password.

**2 [New Password]**

Enter the desired new password. (Up to 16 characters in single byte)

**3 [Retype]**

Enter the desired new password again.

**4 [OK]**

Determines the change of password.

**Note**

- To change the account of the administrator, you must enter the [User name] and [Password] in [Current].

**[Crestron Connected(TM)] page**

The projector can be monitored/controlled with Crestron Connected™.

To start the Crestron Connected™ control page from the web control screen, you need to access with the administrator rights. (For user rights, the [Crestron Connected(TM)] button is not displayed on the web control screen.)

The control page of Crestron Connected™ is displayed by clicking [Crestron Connected(TM)].

It is not displayed if Adobe® Flash® Player is not installed on the computer used, or the browser used does not support Flash. In that case, click [Back] on the control page to go back to the previous page.

**Control page**

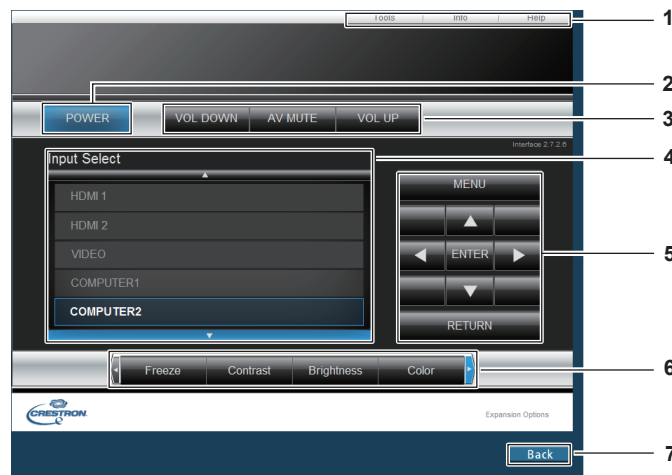

**1 [Tools], [Info], [Help]**

Tabs for selecting the setting, information, or help page of the projector.

**2 [POWER]**

Turns on/off the power.

**3 [VOL DOWN], [AV MUTE], [VOL UP]**

Adjusts the volume.

Switches the AV mute function on/off.

**4 [Input Select]**

Controls input selection.

Not available when the power of the projector is turned off.

**5 Menu screen control buttons**

Navigates the menu screen.

**6 Freeze/image quality adjustment**

Controls items related to freeze/image quality.

**7 [Back]**

Performs return to the previous page.

[Tools] page

Click [Tools] on the control page.

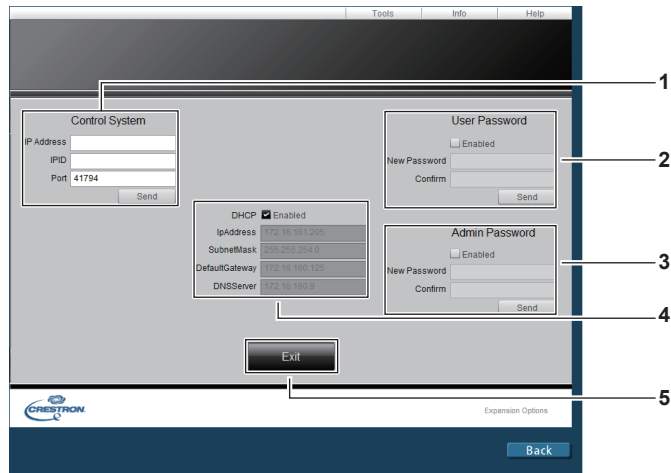

1 [Control System]

Set the information required for communicating with the controller to be connected with the projector.

2 [User Password]

Set the user rights password for the Crestron Connected™ control page.

3 [Admin Password]

Set the administrator rights password for the Crestron Connected™ control page.

4 Network status

Displays the settings of wired LAN.

[DHCP]

Displays the current setting.

[IpAddress]

Displays the current setting.

[SubnetMask]

Displays the current setting.

[DefaultGateway]

Displays the current setting.

[DNSServer]

Displays the current setting.

5 [Exit]

Returns to the control page.

[Info] page

Click [Info] on the control page.

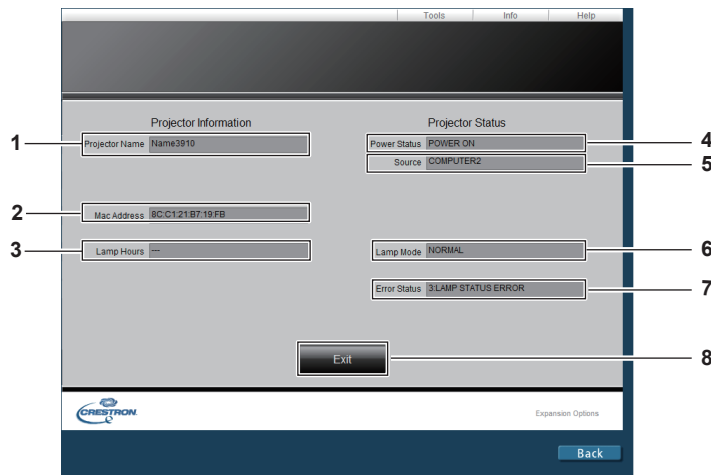

1 [Projector Name]

Displays the projector name.

2 [Mac Address]

Displays the MAC address.

3 [Lamp Hours]

Displays the runtime of the lamp (converted value).

4 [Power Status]

Displays the status of the power.

5 [Source]

Displays the selected input.

6 [Lamp Mode]

Displays the setting status of [LAMP POWER].  
(➔ page 72)

7 [Error Status]

Displays the error status.

8 [Exit]

Returns to the control page.



[Help] page

Click [Help] on the control page.

The [Help Desk] window is displayed.

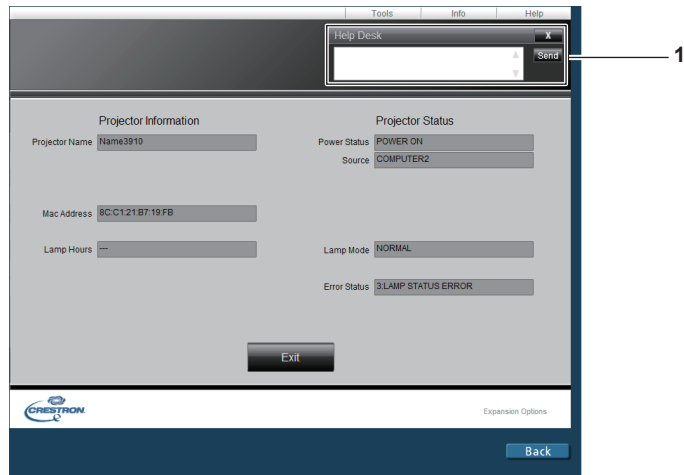

1 [Help Desk]

Send/receive messages to/from an administrator who uses Crestron Connected™.

# Chapter 5 Maintenance

---

This chapter describes methods of inspection when there are problems, maintenance, and replacement of the units.

# Lamp and temperature indicators

## When an indicator lights up

If a problem should occur inside the projector, the lamp indicator <LAMP> and the temperature indicator <TEMP> will inform you by lighting or blinking. Check the status of the indicators and remedy the indicated problems as follows.

### Attention

- Before you take a remedial measure, follow the procedure of switching the power off indicated in “Powering Off the Projector”. (➔ page 40)

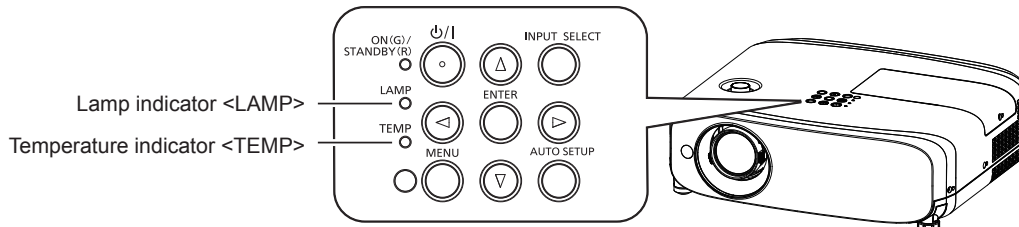

## Lamp indicator <LAMP>

Indicator status	Lighting in red	Blinking in red	
<b>Status</b>	Time to replace the lamp unit. (➔ page 102)	A problem is detected in the lamp or the power supply for the lamp.	
<b>Check</b>	<ul style="list-style-type: none"> <li>• Was [REPLACE LAMP] displayed when you turned on the power?</li> <li>• The indicator lights up when the runtime of the lamp unit has reached 5 000 hours (when [LAMP POWER] is set to [NORMAL]).</li> </ul>	<ul style="list-style-type: none"> <li>• Have you turned on the power again immediately after turning it off?</li> </ul>	<ul style="list-style-type: none"> <li>• Some error has occurred in the lamp circuit. Check for fluctuation (or drop) in the source voltage.</li> </ul>
<b>Remedy</b>	<ul style="list-style-type: none"> <li>• Replace the lamp unit.</li> </ul>	<ul style="list-style-type: none"> <li>• Wait a while until the luminous lamp cools off, and then turn on the power.</li> </ul>	<ul style="list-style-type: none"> <li>• Turn off the projector, and unplug the AC power cord, and consult your dealer.</li> </ul>

### Note

- If the lamp indicator <LAMP> is still lighting or blinking after taking the preceding measures, ask your dealer for repair.

## Temperature indicator <TEMP>

Indicator status	Lighting in red	Blinking in red	Blinking in red (Slow)
<b>Status</b>	The air filter unit is clogged, internal temperature is high (warning).	The air filter unit is clogged, internal temperature is high (standby status).	The projector detects an abnormal condition and cannot be turned on.
<b>Check</b>	<ul style="list-style-type: none"> <li>• Is the air intake/exhaust port blocked?</li> <li>• Is the room temperature high?</li> <li>• Is the air filter unit dirty?</li> </ul>		—
<b>Remedy</b>	<ul style="list-style-type: none"> <li>• Remove any objects that are blocking the air intake/ exhaust port.</li> <li>• Install the projector in a location with an ambient temperature of 0 °C (32 °F) to 40 °C (104 °F)*1.</li> <li>• Do not use the projector at high altitudes of 2 700 m (8 858') or higher above sea level.</li> <li>• Replace the air filter unit. (➔ page 100)</li> </ul>		<ul style="list-style-type: none"> <li>• If the projector is turned off again, unplug the AC power cord and contact the dealer or the service center for service and checkup.</li> </ul>

\*1 When using the projector at high altitudes (between 1 200 m (3 937') and 2 700 m (8 858') above sea level), the operating environment temperature should be between 0 °C (32 °F) and 30 °C (86 °F).

### Note

- If the temperature indicator <TEMP> is still lighting or blinking after taking the preceding measures, ask your dealer for repair.
- If the [LAMP POWER] is set to [NORMAL], [LAMP POWER] may be set to [ECO] forcibly to protect the projector when the operating environment temperature becomes 35 °C (95 °F) ~ 40 °C (104 °F).

# Maintenance/replacement

## Before performing maintenance/replacement

- Make sure to turn off the power before maintaining the projector or replacing the unit. (➔ page 40)
- When switching off the projector, make sure to follow the procedures in “Powering Off the Projector”. (➔ page 40)

## Maintenance

### Outer case

Wipe off dirt and dust with a soft, dry cloth.

- If the dirt is persistent, soak the cloth with water and wring it thoroughly before wiping. Dry off the projector with a dry cloth.
- Do not use benzene, thinner, or rubbing alcohol, other solvents, or household cleaners. Doing so may deteriorate the outer case.
- When using chemically treated dust cloths, follow the instructions written on its packaging.

### Lens front surface

Wipe off dirt and dust from the front surface of the lens with a soft clean cloth.

- Do not use a cloth that is fluffy, dusty, or soaked with oil/water.
- Since the lens is fragile, do not use excessive force when wiping the lens.

### Attention

- The lens is made of glass. Impacts or excessive force when wiping may scratch its surface. Handle with care.

## Replacing the unit

### Air filter unit

The estimated duration before replacement is about 7 000 hours, but it is recommended to replace the air filter unit early if the projector is used in dusty environment.

Replace the air filter unit in the following cases:

- If the air filter unit is clogged, a “Temperature Warning” message is displayed on the screen, and then the temperature indicator <TEMP> lights red, the power of the projector may be turned off automatically and entered into standby mode.
- “FILTER COUNTER has reached the set time.” is displayed.

When purchasing the optional air filter unit (Model No.: ET-RFV400), consult your dealer.

### How to replace the air filter unit

### Attention

- Make sure to turn off the power before replacing the air filter unit.
- Make sure that the projector is stable, and perform the replacement in a safe place where the unit will not be damaged even if you drop the air filter unit.
- After replacing the air filter, reset the filter counter. Otherwise, “FILTER COUNTER has reached the set time.” will appear on screen.

#### 1) Remove the air filter cover.

- Pull out the air filter cover from the hook of the projector while slightly pushing upward the tabs of the air filter cover and open it in the direction of the arrow in figure.

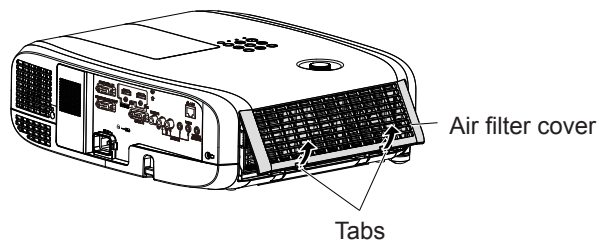

#### 2) Remove the air filter unit.

- Hold the tab on the left side of the air filter unit and pull out in the direction of the arrow.
- After removing the air filter unit, remove foreign objects and dust from the air filter compartment and the projector's air intake port if there are any.

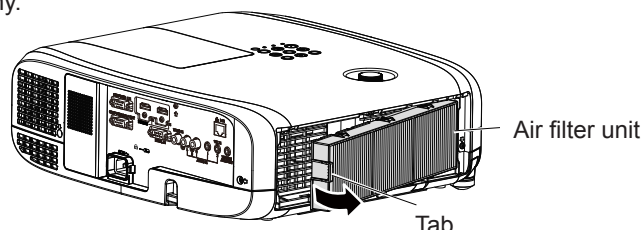

**3) Attach the optional Replacement Filter Unit (Model No.: ET-RFV400) to the projector.**

- Hold the air filter unit that the tab is in left side in the figure, put the right side in the figure first, and press the tab until make a click sound.
- Please press the tab of the air filter unit other than the pleated filter during installation.

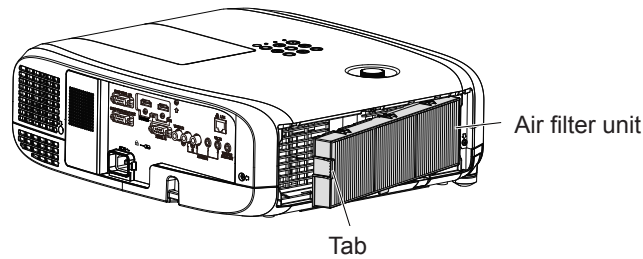

**4) Attach the air filter cover to the projector.**

- Perform Step 1) in "How to replace the air filter unit" (➔ page 100) in the reverse order.
- Make sure that the air filter cover is closed tightly.

**5) Connect the power plug, press the power button <⏻/|> on the control panel or on the remote control to turn on the power.**

**6) Press the <MENU> button to display the main menu, then press ▲▼ to select [PROJECTOR SETUP].**

**7) Press the <ENTER> button, press ▲▼ to select [FILTER COUNTER].**

**8) Press the <ENTER> button, press ▲▼ to select [FILTER COUNTER RESET].**

**9) Press the <ENTER> button.**

- [FILTER COUNTER RESET] confirmation message is displayed.

**10) Press ◀▶ to select [OK], then press the <ENTER> button.**

- The filter usage time is [0] after reset.

**Attention**

- When using the projector, be sure to attach the air filter unit. If it is not attached, the projector will suck in dirt and dust causing a malfunction.
- Do not put anything into the air vents. Doing so may result in malfunction of the projector.
- The air filter unit to be replaced should be an unused product.

**Note**

- The replacement cycle of the air filter unit varies greatly depending on the usage environment.

**Lamp unit**

The lamp unit is a consumable component. Refer to "When to replace the lamp unit" (➔ page 102) for details about the replacement cycle.

When purchasing the optional Replacement Lamp Unit (Model No.: ET-LAV400), consult your dealer.

**Warning**

**Do not replace the lamp unit when it is hot. (Wait at least 1 hour after use.)**

The inside of the cover can become very hot, take care to avoid burn injuries.

**Notes on the replacement of the lamp unit**

- The luminous source of the lamp is made of glass and may burst if you hit it against a hard surface or drop it. Please handle with care.
- A Phillips screwdriver is required for replacement of the lamp unit.
- When replacing the lamp unit, be sure to hold it by the handle.
- When replacing the lamp because it has stopped illuminating, there is a possibility that the lamp may be broken. If replacing the lamp of a projector which has been installed on the ceiling, you should always assume that the lamp is broken, and you should stand to the side of the lamp cover, not underneath it. Remove the lamp cover gently. Small pieces of glass may fall out when the lamp cover is opened. If pieces of glass get into your eyes or mouth, seek medical advice immediately.
- The lamp may be ruptured. Care should be taken not to scatter pieces of the broken lamp glass when replacing the lamp unit. Pieces of the broken lamp may fall from the lamp unit especially when the projector is mounted on the ceiling, so when replacing the lamp unit do not stand directly underneath it or position your face close to it.
- The lamp contains mercury. Consult your local municipality or your dealer about correct disposal of used lamp units.

**Attention**

- Panasonic Connect Co., Ltd. takes no responsibility for any damage or malfunction of the product resulting from use of lamp units which are not manufactured by Panasonic Connect Co., Ltd. Use only specified lamp units.

**Note**

- The model numbers of accessories and optional accessories are subject to change without prior notice.

**When to replace the lamp unit**

The lamp unit is a consumable component. Since its brightness gradually decreases over time, it is necessary to replace the lamp unit regularly.

Time for replacement

When [LAMP POWER] is constantly set to [NORMAL] without switching to other modes = 5 000 hours



When [LAMP POWER] is constantly set to [ECO] without switching to other modes = 7 000 hours

but the lamp may go off before the time above mentioned has elapsed depending on individual lamp characteristics, usage conditions, and the installation environment. It is recommended that the Replacement lamp unit be prepared earlier.

In order to predict the lamp replacement time, please refer to the lamp runtime displayed in [STATUS] (➔ page 71) → [RUNTIME] → [LAMP] → [NORMAL] / [ECO]. It also can be obtained by using the following formula. (The time which is displayed in [ECO] is the converted usage time when set to [NORMAL].)

Formula for lamp replacement time (rough estimate) = "Lamp runtime of [NORMAL]" + "Lamp runtime of [ECO]" × 5/7

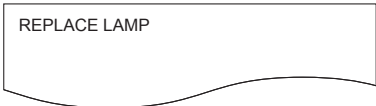
If the time which is obtained by the above equation 5 000 hours has elapsed, the lamp turns off automatically after approximately 10 minutes, as it will cause malfunction of the projector.

Time which is obtained by the above equation	On-screen display 	Lamp indicator <LAMP> 
Over 4 800 hours	The message is displayed for 30 seconds. If you press any button within the 30 seconds, the message disappears.	Lights in red (even in stand-by mode).
Over 5 000 hours	If the power is turned on without replacing the lamp, the power automatically turns off after approximately ten minutes to prevent the malfunction of the projector.	

**Note**

- The time which is obtained by the formula for lamp replacement time "5 000 hours" is a rough guideline, but is not a guarantee. The lamp runtime differs depending on the setting of "LAMP POWER" menu.

**Replacing the Lamp unit**

**Attention**

- When the projector is mounted on a ceiling, do not work with your face close to the projector.
- Do not loosen other than designated screws.
- Attach the lamp unit and the lamp cover securely.

- 1) **Turn off the Power by following the procedure in "Powering Off the Projector". (➔ page 40)**  
**Remove the AC power plug from the wall outlet.**
  - Wait at least 1 hour and make sure the lamp unit and surroundings are cool.
- 2) **Use a Phillips screwdriver to loosen the lamp cover fixing screw (×1) until it turns freely and remove the lamp cover.**
  - Remove the lamp cover by pulling it slowly toward the direction of the arrow.

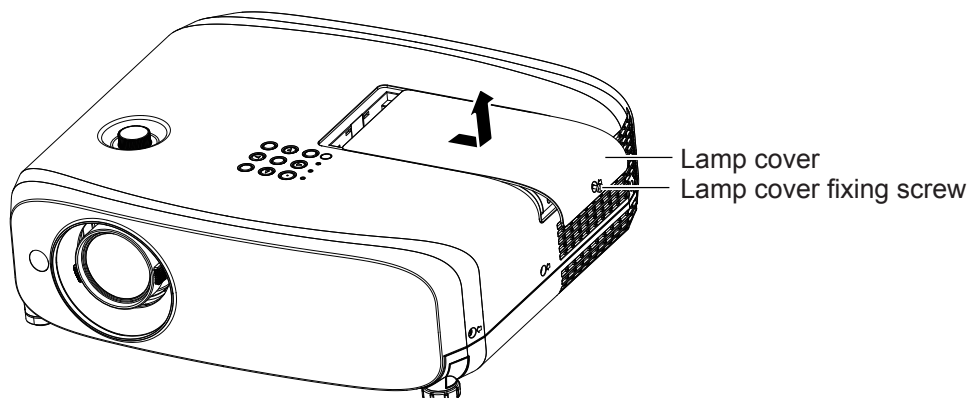

- 3) Use a Phillips screwdriver to loosen the three lamp unit fixing screws (×3) until they turn freely.
- 4) Hold the used lamp unit by its handles, and pull it gently from the projector.

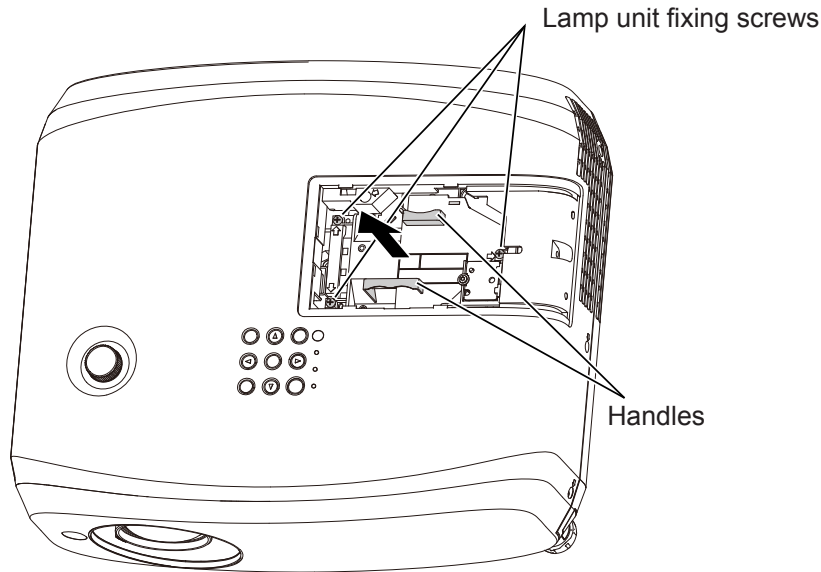

- 5) Insert the new lamp unit in correct direction. Tighten the three lamp unit fixing screws (×3) securely with a Phillips screwdriver.
  - When you experience difficulty in installing the lamp unit, remove it and try again. If you use force to install the lamp unit, the connector may be damaged.
- 6) Attach the lamp cover. Tighten the lamp cover fixing screw (×1) securely with a Phillips screwdriver.
  - Perform Step 2) in the reverse order to attach the lamp cover.

---

**Note**

- When you replace the lamp unit with new one, the projector resets the runtime of the lamp unit automatically.

# Troubleshooting

Please check following points. For details, see the corresponding pages.

Problem	Cause	Reference page
<b>Power does not turn on.</b>	<ul style="list-style-type: none"> <li>The power cord may not be connected.</li> <li>No electric supply is at the wall outlet.</li> <li>The circuit breakers have tripped.</li> <li>Is the lamp indicator &lt;LAMP&gt; or temperature indicator &lt;TEMP&gt; lit or blinking?</li> <li>The lamp cover has not been securely installed.</li> </ul>	37 — — 99 102
<b>No picture appears.</b>	<ul style="list-style-type: none"> <li>Are connections to external devices correctly performed?</li> <li>The input selection setting may not be correct.</li> <li>The [BRIGHTNESS] adjustment setting may be at the minimum setting.</li> <li>Is the external device that is connected to the projector working properly?</li> <li>The AV MUTE function may be in use.</li> </ul>	34 41 52 — 45, 70
<b>The picture is fuzzy.</b>	<ul style="list-style-type: none"> <li>The lens cap is still attached to the lens.</li> <li>The lens focus may not have been set correctly.</li> <li>The projector may not be at the correct distance from the screen.</li> <li>The lens may be dirty.</li> <li>The projector may be tilted too much.</li> </ul>	20 41 30 19 —
<b>The color is pale or grayish.</b>	<ul style="list-style-type: none"> <li>[COLOR] or [TINT] adjustment may be incorrect.</li> <li>The input source which is connected to the projector may not be adjusted correctly.</li> <li>RGB cable is damaged.</li> </ul>	53 — —
<b>No sound from the internal speaker.</b>	<ul style="list-style-type: none"> <li>Is the external device connected correctly to the audio input terminal?</li> <li>The volume may have been set to the minimum level.</li> <li>The AV MUTE function may have been turned on.</li> <li>When the &lt;VARIABLE AUDIO OUT&gt; terminal is plugged-in, the projector's built-in speaker is not available.</li> <li>The MUTE function may have been turned on.</li> <li>Is the audio input selection in [AUDIO SETTING] set correctly?</li> </ul>	34, 35 43, 75 45, 70 34, 35 45, 75 75
<b>The remote control does not operate.</b>	<ul style="list-style-type: none"> <li>The batteries may be weak.</li> <li>The batteries may not have been inserted correctly.</li> <li>The remote control signal receiver on the projector may be obstructed.</li> <li>The remote control unit may be out of the operation range.</li> <li>Strong light such as fluorescent shine onto the signal receiver.</li> <li>The [REMOTE CONTROLLER] setting is set to [DISABLE] in [CONTROL DEVICE SETUP].</li> <li>Is the ID number setting operation correct?</li> </ul>	— 26 23 23 23 80 45
<b>Menu screen does not appear.</b>	<ul style="list-style-type: none"> <li>Is the on-screen display function turned off (hidden)?</li> </ul>	65
<b>The control buttons of the projector do not operate.</b>	<ul style="list-style-type: none"> <li>The [CONTROL PANEL] setting is set to [DISABLE] in [CONTROL DEVICE SETUP].</li> </ul>	80
<b>The picture does not display correctly.</b>	<ul style="list-style-type: none"> <li>There may be a problem with the VCR or other signal source.</li> <li>A signal which is not compatible with the projector is being input.</li> </ul>	— 112
<b>Picture from a computer does not appear.</b>	<ul style="list-style-type: none"> <li>The cable may be longer than the optional cable.</li> <li>The external video output from a laptop computer may not be correct.</li> </ul>	— —
<b>Video from HDMI compatible device does not appear or it appears jumbled.</b>	<ul style="list-style-type: none"> <li>Is the HDMI cable securely connected?</li> <li>Turn off the power of the projector and the connected devices. Then turn the power of the projector and the connected devices back on.</li> <li>Is a signal which is not compatible with the projector being input?</li> </ul>	34, 35 — 112
<b>Audio from HDMI compatible device does not appear.</b>	<ul style="list-style-type: none"> <li>Set to the linear PCM audio for the connected devices.</li> </ul>	—

## Attention

- If the problem persists, after confirming the contents of the table, please consult your dealer.



# Chapter 6 **Appendix**

---

This chapter describes specifications and after-sales service for the projector.

# Technical information

## PJLink protocol

The network function of the projector supports PJLink class 1, and the PJLink protocol can be used to perform projector setting and projector status query operations from a computer.

### Control commands

The following table lists the PJLink protocol commands that can be used to control the projector.

- x characters in tables are non-specific characters.

Command	Control details	Parameter / return string	Remark		
POWR	Power supply control	0 1	Standby Power on		
POWR ?	Power supply status query	0 1 2 3	Standby Power on Cool-down in progress Warm-up in progress		
INPT	Input selection	11 12 21	RGB 1 RGB 2 VIDEO		
INPT ?	Input selection query	31 32	HDMI1 HDMI2		
AVMT	AV MUTE control	30	AV MUTE mode off		
AVMT ?	AV MUTE status query	31	AV MUTE mode on		
ERST ?	Error status query	xxxxxx	1st byte	Indicates fan errors, range 0 – 2	<ul style="list-style-type: none"> <li>• 0 = No error known</li> <li>• 1 = Warning</li> <li>• 2 = Error</li> </ul>
			2nd byte	Indicates lamp errors, range 0 – 2	
			3rd byte	Indicates temperature errors, range 0 – 2	
			4th byte	Fixed at 0	
			5th byte	Indicates filter errors, range 0 – 2	
			6th byte	Indicates other errors, range 0 – 2	
LAMP ?	Lamp status query	xxxxxx	1st digits (1 – 5 digits) : Lamp cumulative operating time 2nd digit : 0 = Lamp off, 1 = Lamp on		
INST ?	Input selection list query	11 12 21 31 32			
NAME ?	Projector name query	xxxxx	Returns the name set in [NAME CHANGE] of [NETWORK].		
INF1 ?	Manufacturer name query	Panasonic	Returns manufacturer name.		
INF2 ?	Model name query	VZ470	Returns model name.		
INF0 ?	Other information query	xxxxx	Returns information such as version number.		
CLSS ?	Class information query	1	Returns class for PJLink.		

### PJLink security authentication

The password used for PJLink is the same as that of the password set for web control.

When using the projector without security authentication, do not set a password for web control.

- For specifications related to PJLink, refer to the website of Japan Business Machine and Information System Industries Association.

URL <http://pjlink.jbmia.or.jp/english/>

## Control commands via LAN

### When WEB Control administrator rights password is set (Protect mode)

#### Connection method

- 1) Obtain the IP address and port number (Initial set value = 1 024) of the projector and make a request for connection to the projector.

- Acquire the IP address from the menu screen of the projector, and the port number from the WEB control page.

<b>IP address :</b>	Obtain from MAIN MENU → [NETWORK] → [STATUS]
<b>Port No. :</b>	Acquire from the WEB control → [Detailed set up] → [Command port set up] page

- 2) There is a response from the projector.

	Data section	Blank	Mode	Blank	Random number section	Termination symbol
<b>Command example</b>	"NTCONTROL" (ASCII string)	' '	'1'	' '	"ZZZZZZZ" (ASCII code hexadecimal number)	(CR) 0x0d
<b>Data length</b>	9 bytes	1 byte	1 byte	1 byte	8 bytes	1 byte

- Mode : 1 = Protect mode

- 3) Generate a 32-byte hash value from the following data using MD5 algorithm.

- "xxxxxx:yyyyy:zzzzzzz"

<b>xxxxxx :</b>	Administrator rights user name for WEB CONTROL (Default user name is "admin1")
<b>yyyyy :</b>	Password of above administrator rights user (Default password is "panasonic")
<b>zzzzzzz :</b>	8-byte random number obtained in Step 2

#### Command transmission method

Transmit using the following command format.

##### ■ Transmitted data

	Header			Data section	Termination symbol
<b>Command example</b>	Hash value (See above <Connection method>)	'0'	'0'	Control command (ASCII string)	(CR) 0x0d
<b>Data length</b>	32 bytes	1 byte	1 byte	Undefined length	1 byte

##### ■ Receive data

	Header		Data section	Termination symbol
<b>Command example</b>	'0'	'0'	Control command (ASCII string)	(CR) 0x0d
<b>Data length</b>	1 byte	1 byte	Undefined length	1 byte

##### ■ Error response

	String	Details	Termination symbol
<b>Message</b>	"ERR1"	Undefined control command	(CR) 0x0d
	"ERR2"	Out of parameter range	
	"ERR3"	Busy state or no-acceptable period	
	"ERR4"	Timeout or no-acceptable period	
	"ERR5"	Wrong data length	
	"ERRA"	Password mismatch	
<b>Data length</b>	4 bytes	—	1 byte

**When WEB Control administrator rights password is not set (Non-protect mode)****Connection method****1) Obtain the IP address and port number (Initial set value = 1 024) of the projector and make a request for connection to the projector.**

- Acquire the IP address from the menu screen of the projector, and the port number from the WEB control page.

<b>IP address :</b>	Obtain from main menu → [NETWORK] → [STATUS]
<b>Port No. :</b>	Acquire from the WEB control → [Detailed set up] → [Command port set up] page

**2) There is a response from the projector.****■ Response data**

	Data section	Blank	Mode	Termination symbol
<b>Command example</b>	"NTCONTROL" (ASCII string)	' '	'0'	(CR)
<b>Data length</b>	9 bytes	0x20	0x30	0x0d
		1 byte	1 byte	1 byte

- Mode : 0 = Non-protect mode

**Command transmission method**

Transmit by the following command format.

**■ Transmitted data**

	Header		Data section	Termination symbol
<b>Command example</b>	'0'	'0'	Control command (ASCII string)	(CR)
<b>Data length</b>	0x30	0x30	Undefined length	0x0d
	1 byte	1 byte		1 byte

**■ Receive data**

	Header		Data section	Termination symbol
<b>Command example</b>	'0'	'0'	Control command (ASCII string)	(CR)
<b>Data length</b>	0x30	0x30	Undefined length	0x0d
	1 byte	1 byte		1 byte

**■ Response data**

	String	Details	Termination symbol
<b>Message</b>	"ERR1"	Undefined control command	(CR) 0x0d
	"ERR2"	Out of parameter range	
	"ERR3"	Busy state or no-acceptable period	
	"ERR4"	Timeout or no-acceptable period	
	"ERR5"	Wrong data length	
	"ERRA"	Password mismatch	
<b>Data length</b>	4 bytes	—	1 byte

## <SERIAL IN> terminal

The <SERIAL IN> terminal of the projector conforms with RS-232C so that the projector can be connected to and controlled from a computer.

### Connection

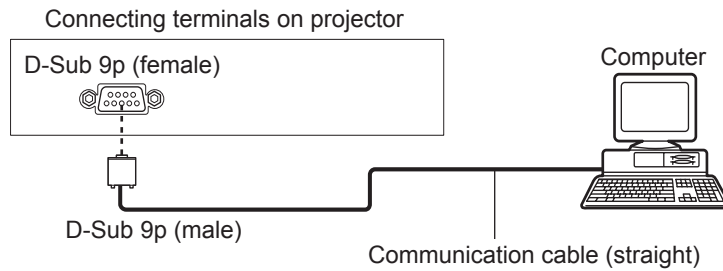

### Pin assignments and signal names

D-Sub 9-pin (female) Outside view	Pin No.	Signal name	Contents
	①	—	NC
	②	TXD	Transmitted data
	③	RXD	Received data
	④	—	NC
	⑤	GND	Earth
	⑥	—	NC
	⑦	CTS	Connected internally
	⑧	RTS	
	⑨	—	NC

### Communication conditions (Factory default)

<b>Signal level</b>	RS-232C-compliant
<b>Sync. method</b>	Asynchronous
<b>Baud rate</b>	9 600 bps
<b>Parity</b>	None
<b>Character length</b>	8 bits
<b>Stop bit</b>	1 bit
<b>X parameter</b>	None
<b>S parameter</b>	None

**Basic format**

Transmission from the computer starts with STX, then the ID, command, parameter, and ETX are sent in this order. Add parameters according to the details of control.

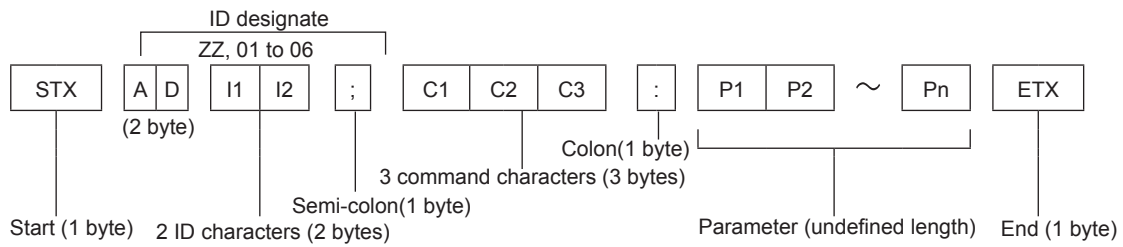

**Basic format (with sub command)**

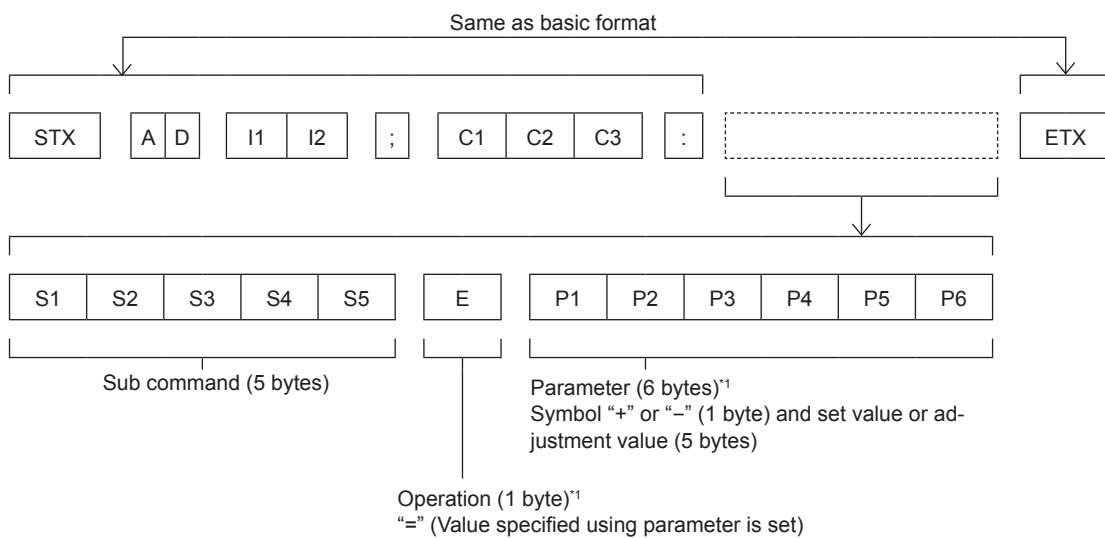

\*1 When transmitting a command which does not need a parameter, the operation (E) and parameter are not necessary.

**Attention**

- If a command is transmitted after the lamp starts illuminating, there may be a delay in response or the command may not be executed. Try sending or receiving any command after 60 seconds.
- When transmitting multiple commands, be sure to wait until 0.5 seconds has elapsed after receiving the response from the projector before sending the next command. When transmitting a command which does not need a parameter, a colon (:) is not necessary.

**Note**

- If a command cannot be executed, the “ER401” response is sent from the projector to the computer.
- If an invalid parameter is sent, the “ER402” response is sent from the projector to the computer.
- ID transmission in RS-232C supports ZZ (ALL) and 01 to 06.
- If a command is sent with a specified ID, a response will be sent to the computer only in the following cases.
  - It matches the projector ID.
  - [PROJECTOR ID] is set to [ALL]. (➔ page 72)
- STX and ETX are character codes. STX shown in hexadecimal is 02, and ETX shown in hexadecimal is 03.

## Cable specifications

[When connected to a computer]

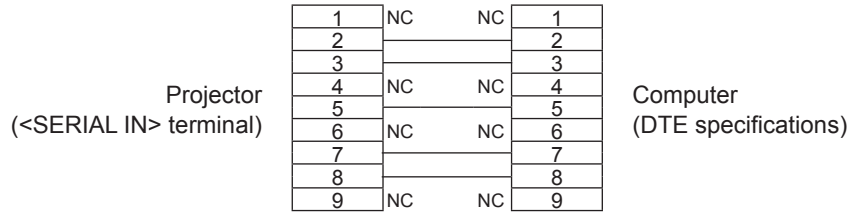

## Control commands

When controlling the projector from a computer, the following commands are available.

### ■ Projector control command

Command	Control contents	Parameter / return string	Remarks
PON	Power on	—	To check if the power is on, use the “Power query” command.
POF	Power off		
IIS	INPUT selection	VID RG1 RG2 HD1 HD2	VIDEO RGB1 RGB2 HDMI1 HDMI2
OFZ	Freeze	0	[OFF]
		1	[ON]
AUU	Volume up		
AUD	Volume down		
DZU	D. ZOOM up		
DZD	D. ZOOM down		
OSH	AV mute function	0	AV MUTE mode off
		1	AV MUTE mode on
QPW	Power query	000	Standby
		001	Power on
Q\$\$	Lamp condition query	0	Stand-by
		1	Lamp ON control active
		2	Lamp ON
		3	Lamp OFF control active

## [MENU LOCK PASSWORD] operations

To initialize your password, consult your distributor.

## List of compatible signals

The following table specifies the type of signals compatible with the projectors.

- Symbols that indicate formats are as follows.

- V : VIDEO
- R : RGB
- Y : YC<sub>B</sub>C<sub>R</sub>/YP<sub>B</sub>P<sub>R</sub>
- H : HDMI

Mode	Display resolution (dots)	Scanning frequency		Dot clock frequency (MHz)	Format	PnP*1	
		H (kHz)	V (Hz)			COMPUTER1 / COMPUTER2	HDMI
NTSC/NTSC4.43/ PAL-M/PAL60	720 x 480i	15.7	59.9	—	V	—	—
PAL/PAL-N/SECAM	720 x 576i	15.6	50.0	—	V	—	—
525i (480i)	720 x 480i	15.7	59.9	13.5	R/Y	—	—
625i (576i)	720 x 576i	15.6	50.0	13.5	R/Y	—	—
525i (480i)	720 (1 440) x 480i <sup>2</sup>	15.7	59.9	27.0	H	—	—
625i (576i)	720 (1 440) x 576i <sup>2</sup>	15.6	50.0	27.0	H	—	—
525p (480p)	720 x 483	31.5	59.9	27.0	R/Y/H	—	✓
625p (576p)	720 x 576	31.3	50.0	27.0	R/Y/H	—	✓
750 (720) /60p	1 280 x 720	45.0	60.0	74.3	R/Y/H	—	✓
750 (720) /50p	1 280 x 720	37.5	50.0	74.3	R/Y/H	—	✓
1125 (1080) /60i <sup>3</sup>	1 920 x 1 080i	33.8	60.0	74.3	R/Y/H	—	✓
1125 (1080) /50i	1 920 x 1 080i	28.1	50.0	74.3	R/Y/H	—	✓
1125 (1080) /24p	1 920 x 1 080	27.0	24.0	74.3	R/Y/H	—	✓
1125 (1080) /24sF	1 920 x 1 080i	27.0	48.0	74.3	R/Y/H	—	—
1125 (1080) /25p	1 920 x 1 080	28.1	25.0	74.3	R/Y/H	—	—
1125 (1080) /30p	1 920 x 1 080	33.8	30.0	74.3	R/Y/H	—	—
1125 (1080) /60p	1 920 x 1 080	67.5	60.0	148.5	R/Y/H	—	✓
1125 (1080) /50p	1 920 x 1 080	56.3	50.0	148.5	R/Y/H	—	✓
640 x 400	640 x 400	31.5	70.1	25.2	R/H	—	—
	640 x 400	37.9	85.1	31.5	R/H	—	—
VGA	640 x 480	31.5	59.9	25.2	R/H	✓	✓
	640 x 480	35.0	66.7	30.2	R/H	—	—
	640 x 480	37.9	72.8	31.5	R/H	✓	✓
	640 x 480	37.5	75.0	31.5	R/H	✓	✓
	640 x 480	43.3	85.0	36.0	R/H	—	—
SVGA	800 x 600	35.2	56.3	36.0	R/H	✓	✓
	800 x 600	37.9	60.3	40.0	R/H	✓	✓
	800 x 600	48.1	72.2	50.0	R/H	✓	✓
	800 x 600	46.9	75.0	49.5	R/H	✓	✓
	800 x 600	53.7	85.1	56.3	R/H	—	—
MAC16	832 x 624	49.7	74.6	57.3	R/H	✓	✓
XGA	1 024 x 768	39.6	50.0	51.9	R/H	—	—
	1 024 x 768	48.4	60.0	65.0	R/H	—	—
	1 024 x 768	56.5	70.1	75.0	R/H	✓	✓
	1 024 x 768	60.0	75.0	78.8	R/H	✓	✓
	1 024 x 768	65.5	81.6	86.0	R/H	—	—
	1 024 x 768	68.7	85.0	94.5	R/H	—	—
	1 024 x 768	81.4	100.0	113.3	R/H	—	—
1152 x 864	1 152 x 864	53.7	60.0	81.6	R/H	—	—
	1 152 x 864	67.5	74.9	108.0	R/H	—	—
	1 152 x 864	77.1	85.0	119.7	R/H	—	—
MAC21	1 152 x 870	68.7	75.1	100.0	R/H	✓	✓



Mode	Display resolution (dots)	Scanning frequency		Dot clock frequency (MHz)	Format	PnP*1	
		H (kHz)	V (Hz)			COMPUTER1 / COMPUTER2	HDMI
1280 x 720	1 280 x 720	37.1	49.8	60.5	R/H	—	—
	1 280 x 720	44.8	59.9	74.5	R/H	—	—
1280 x 768	1 280 x 768	60.3	74.9	102.3	R/H	—	—
	1 280 x 768	68.6	84.8	117.5	R/H	—	—
1280 x 800	1 280 x 800	41.3	50.0	68.0	R/H	—	—
	1 280 x 800	49.7	59.8	83.5	R/H	—	—
	1 280 x 800	62.8	74.9	106.5	R/H	—	—
	1 280 x 800	71.6	84.9	122.5	R/H	—	—
1280 x 960	1 280 x 960	60.0	60.0	108.0	R/H	—	—
SXGA	1 280 x 1 024	64.0	60.0	108.0	R/H	—	—
	1 280 x 1 024	80.0	75.0	135.0	R/H	—	—
	1 280 x 1 024	91.1	85.0	157.5	R/H	—	—
1366 x 768	1 366 x 768	39.6	49.9	69.0	R/H	—	—
	1 366 x 768	47.7	59.8	85.5	R/H	—	—
1400 x 1050	1 400 x 1 050	65.2	60.0	122.6	R/H	—	—
	1 400 x 1 050	65.3	60.0	121.8	R/H	—	—
	1 400 x 1 050	82.2	75.0	156.0	R/H	—	—
1440 x 900	1 440 x 900	55.9	60.0	106.5	R/H	—	—
1600 x 900	1 600 x 900	46.3	50.0	97.0	R/H	—	—
	1 600 x 900	55.9	60.0	119.0	R/H	—	—
UXGA	1 600 x 1 200	75.0	60.0	162.0	R/H	✓	✓
1680 x 1050	1 680 x 1 050	54.1	50.0	119.5	R/H	—	—
	1 680 x 1 050	65.3	60.0	146.3	R/H	—	—
1920 x 1080	1 920 x 1 080	55.6	49.9	141.5	R/H	—	—
	1 920 x 1 080 <sup>*4</sup>	66.6	59.9	138.5	R/H	—	—
	1 920 x 1 080 <sup>*5</sup>	67.2	60.0	173.0	R	—	—
WUXGA	1 920 x 1 200	61.8	49.9	158.3	R/H	—	—
	1 920 x 1 200 <sup>*4</sup>	74.0	60.0	154.0	R/H	✓	✓
	1 920 x 1 200 <sup>*5</sup>	74.6	59.9	193.3	R	—	—

\*1 Where marked "✓" signals indicates in Plug and Play is compatible with EDID of projector. Unmarked signals in Plug and Play may also be compliant if input terminals are written in the format list. Where Plug and Play is unmarked and nothing is written in the format list, difficulties in projecting image may occur even when computer and projector appear to have same resolution.

\*2 Pixel-Repetition signal (dot clock frequency 27.0 MHz) only

\*3 When a 1125 (1035)/60i signal was input, it is displayed as a 1125 (1080)/60i signal.

\*4 VESA CVT-RB (Reduced Blanking)-compliant

\*5 Samples the pixels in the image processing circuit and displays the image.

## Note

- The number of display dots is 1 920 x 1 200.  
A signal with a different resolution will be projected after converting the resolution to match the projector display.
- "i" added to the resolution value indicates an interlaced signal.
- When interlaced signals are connected, flicker may occur on the projected image.
- Even the above signals exist, some image signals that recorded in special method may not be displayed.

# Specifications

The specifications of this projector are as follows.

<b>Power supply</b>		120 V $\sim$ (120 V alternating current), 50 Hz/60 Hz (For North America) 100 V - 240 V $\sim$ (100 V - 240 V alternating current), 50 Hz/60 Hz (For other countries)
<b>Power consumption</b>		372 W (3.5 A) (For North America) 378 W (4.3 A -1.7 A) (For other countries) When [STANDBY MODE] of [ECO MANAGEMENT] is set to [ECO] : 0.2 W (For North America), 0.4 W (For other countries) When [STANDBY MODE] of [ECO MANAGEMENT] is set to [NORMAL] : 8 W When [STANDBY MODE] of [ECO MANAGEMENT] is set to [NORMAL], and [IN STANDBY MODE] of [AUDIO SETTING] is set to [ON] : 20 W
<b>LCD panel</b>	<b>Size</b>	1.63 cm (0.64") (aspect ratio 16 : 10)
	<b>Display system</b>	Translucent screen LCD panel 3 panels, 3 primary color system
	<b>Drive system</b>	Active matrix
	<b>Number of pixels</b>	2 304 000 pixels (1 920 x 1 200 dots) x 3 panels
<b>Lens</b>		Manual zoom : 1.6x Focus : F 1.6 - 2.12, f 15.30 mm - 24.64 mm
<b>Luminous lamp</b>		270 W, UHM lamp
<b>Light output *1</b>		4 400 lm
<b>Contrast ratio *1</b>		10 000 : 1 (When [PICTURE MODE] is set to [DYNAMIC], [LAMP POWER] is set to [NORMAL], [IRIS] is set to [ON], [DAYLIGHT VIEW] is set to [OFF], and [AUTO POWER SAVE] is set to [OFF])
<b>Applicable scanning frequency</b>	<b>For video signal</b>	Horizontal : 15.73 kHz Vertical : 59.94 Hz, Horizontal : 15.63 kHz Vertical : 50 Hz
	<b>For Y/C signal</b>	Horizontal : 15.73 kHz Vertical : 59.94 Hz, Horizontal : 15.63 kHz Vertical : 50 Hz
	<b>For RGB signal</b>	Horizontal 15 kHz to 91 kHz, Vertical 24 Hz to 100 Hz
		Dot clock frequency: 162 MHz or less
	<b>For YP<sub>B</sub>P<sub>R</sub> signal</b>	[525i(480i)] Horizontal 15.73 kHz, Vertical 59.94 Hz
		[625i(576i)] Horizontal 15.63 kHz, Vertical 50 Hz
[525p(480p)] Horizontal 31.47 kHz, Vertical 59.94 Hz		
[625p(576p)] Horizontal 31.25 kHz, Vertical 50 Hz		
[750(720)/60p] Horizontal 45.00 kHz, Vertical 60 Hz		
[750(720)/50p] Horizontal 37.50 kHz, Vertical 50 Hz		
[1125(1080)/60i] Horizontal 33.75 kHz, Vertical 60 Hz		
[1125(1080)/50i] Horizontal 28.13 kHz, Vertical 50 Hz		
[1125(1080)/60p] Horizontal 67.50 kHz, Vertical 60 Hz		
[1125(1080)/50p] Horizontal 56.25 kHz, Vertical 50 Hz		
[1125(1080)/24p] Horizontal 27.00 kHz, Vertical 24 Hz		
[1125(1080)/24sF] Horizontal 27.00 kHz, Vertical 48 Hz		
[1125(1080)/25p] Horizontal 28.13 kHz, Vertical 25 Hz		
[1125(1080)/30p] Horizontal 33.75 kHz, Vertical 30 Hz		
<b>For HDMI signal</b>	525i(480i)*2, 625i(576i)*2, 525p(480p), 625p(576p), 750(720)/60p, 750(720)/50p, 1125(1080)/24p, 1125(1080)/24sF, 1125(1080)/25p, 1125(1080)/30p, 1125(1080)/60p, 1125(1080)/50p, 1125(1080)/60i, 1125(1080)/50i Displayable resolution: VGA to WUXGA (non-interlace) Dot clock frequency: 25 MHz to 162 MHz	
<b>Color system</b>		7 (NTSC, NTSC4.43, PAL, PAL-N, PAL-M, SECAM, PAL60)
<b>Projection size</b>		0.76 m -7.62 m (30"-300")
<b>Screen aspect ratio</b>		16:10
<b>Projection scheme</b>		[FRONT/DESK], [FRONT/CEILING], [REAR/DESK], [REAR/CEILING] (Menu setting system)
<b>Speaker</b>		1 (4.0 cm round-type)
<b>Maximum usable volume output</b>		10 W

Terminals	<COMPUTER 1 IN>	1 set, high-density D-Sub 15 p (female) [RGB signal] 0.7 V [p-p] 75 Ω (When G-SYNC: 1.0 V [p-p] 75 Ω) HD/SYNC TTL high impedance, automatic positive/negative polarity compatible VD TTL high impedance, automatic positive/negative polarity compatible (SYNC/HD and VD do not support 3 value SYNC.) [Y <sub>B</sub> P <sub>R</sub> signal] Y: 1.0 V [p-p] including synchronization signal, P <sub>B</sub> P <sub>R</sub> : 0.7 V [p-p] 75 Ω [Y/C signal] Y: 1.0 V [p-p], C: 0.286 V [p-p] 75 Ω
	<COMPUTER 2 IN/ 1 OUT>	1 set, high-density D-Sub 15 p (female) [RGB signal] 0.7 V [p-p] 75 Ω (When G-SYNC: 1.0 V [p-p] 75 Ω) HD/SYNC TTL high impedance, automatic positive/negative polarity compatible VD TTL high impedance, automatic positive/negative polarity compatible (SYNC/HD and VD do not support 3 value SYNC.) [Y <sub>B</sub> P <sub>R</sub> signal] Y: 1.0 V [p-p] including synchronization signal, P <sub>B</sub> P <sub>R</sub> : 0.7 V [p-p] 75 Ω
	<VIDEO IN>	1 set, pin jack 1.0 V [p-p] 75 Ω
	<HDMI 1 IN> / <HDMI 2 IN>	2 set (HDMI 19 pin, HDCP and Deep color compatible) Audio signals: Linear PCM (Sampling frequency: 48 kHz/44.1 kHz/32 kHz)
	<AUDIO IN>	2 set (M3 stereo mini jack, 0.5 V [rms], input impedance 22 kΩ and more) (<AUDIO IN 2 (MIC IN)> terminal support MIC input) 1 set (Pin jack x 2 (L-R), 0.5 V [rms], input impedance 22 kΩ and more)
	<VARIABLE AU- DIO OUT>	1 set (M3 stereo mini jack, stereo monitor output compatible, 0 V [rms] to 2.0 V [rms] variable, output impedance 2.2 kΩ and less)
	<SERIAL IN>	1 set (D-sub 9 pin, RS-232C compliant, for computer control use)
	<LAN>	1 set (for RJ-45 network connection, PLink compatible, 10Base-T/100Base-TX)
Power cable length		<b>PT-VZ470</b> 2.0 m (78-3/4") <b>PT-VZ470D</b> 3.0 m (118-1/8")
Cabinet		Molded plastic
Dimensions		Width: 389 mm (15-5/16") Height: 125 mm (4-29/32") (when adjustable feet shortened) Depth: 332 mm (13-1/16")
Weight		Approx. 4.8 kg (10.58 lbs.) *3
Noise level *1		When set to [NORMAL] in [LAMP POWER] : 37 dB When set to [ECO] in [LAMP POWER] : 29 dB
Operating environment		Operating environment temperature *4: 0 °C (32 °F) to 40 °C (104 °F) (Elevation: below 1 200 m (3 937')) 0 °C (32 °F) to 30 °C (86 °F) (Elevation: 1 200 m (3 937') ~ 2 700 m (8 858')) Operating environment humidity: 20 % to 80 % (no condensation)
Remote control	Power supply	DC 3 V (AAA/R03/LR03 battery x 2)
	Operating range	Approx. 7 m (22'11-5/8") (when operated directly in front of receiver)
	Weight	63 g (2.22 ozs.) (including batteries)
	Dimensions	Width : 44 mm (1-23/32"), Length : 105 mm (4-1/8"), Height : 20.5 mm (13/16")

\*1 Measurement, measuring conditions and method of notation all comply with ISO/IEC 21118:2012 international standards.

\*2 Pixel-Repetition signal (dot clock frequency 27.0 MHz) only

\*3 This is an average value. It may differ depending on individual product.

\*4 [LAMP POWER] will be switched to [ECO] automatically when the operating environment temperature is 35 °C (95 °F) to 40 °C (104 °F).

**Note**

- The part numbers of accessories and separately sold components are subject to change without notice.

# Dimensions

<Unit : mm (inch)>

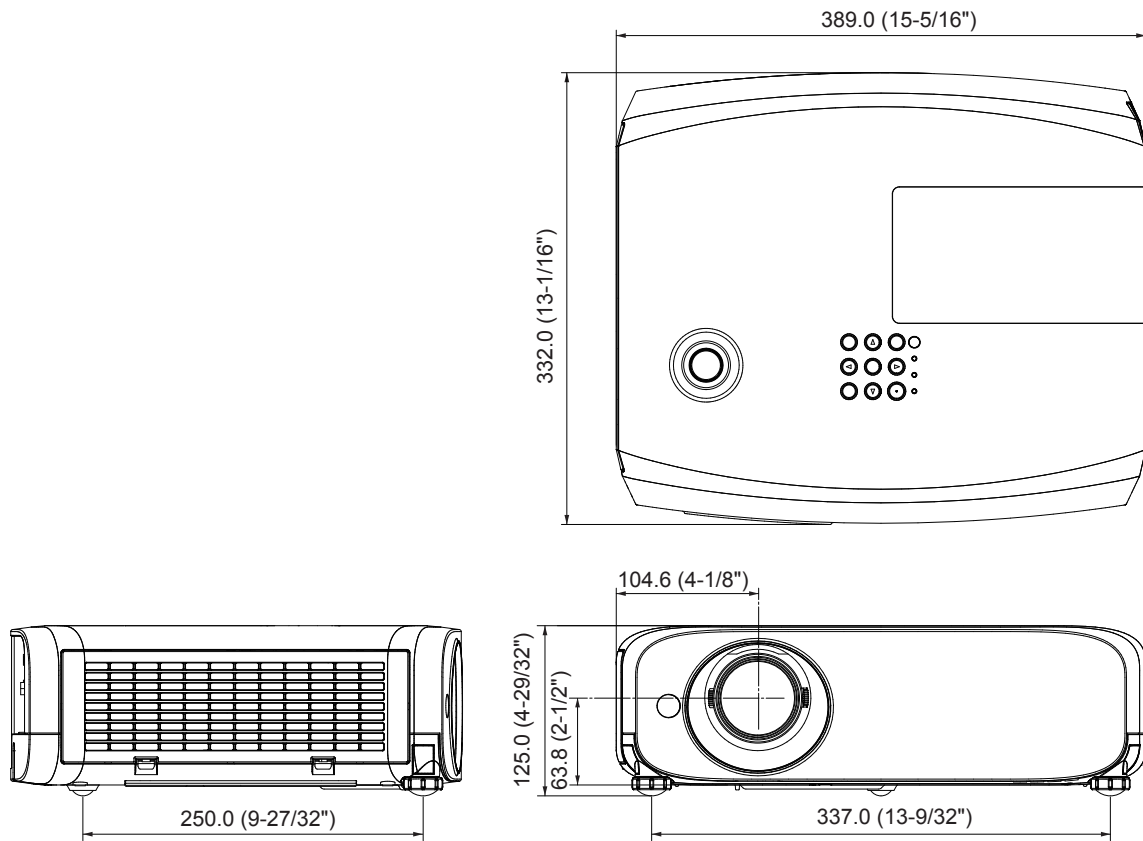

\* Actual dimension may differ by product.

# Ceiling mount bracket safeguards

- When installing the projector to a ceiling, be sure to use the specified optional Ceiling Mount Bracket for Projectors.  
Model No. of ceiling mount bracket:
  - ① ET-PKL100S (for low ceilings); ET-PKV400B (Projector mount bracket)
  - ② ET-PKL100H (for high ceilings); ET-PKV400B (Projector mount bracket)
- When installing the projector, attach the drop-prevention kit included with the Ceiling Mount Bracket for Projectors.
- Ask a qualified technician to do the installation work such as mounting the projector on the ceiling.
- Panasonic Connect Co., Ltd. takes no responsibility for any damage to the projector resulting from use of a ceiling mount bracket not manufactured by Panasonic Connect Co., Ltd. or the inappropriate choice of location for installation, even if the warranty period of the projector has not expired.
- Unused products must be removed promptly by a qualified technician.
- Use a torque screwdriver or Allen torque wrench to tighten bolts to their specified tightening torques. Do not use electric screwdrivers or impact screwdrivers.
- Read the Installation Instructions for the Ceiling Mount Bracket for Projectors for details.
- The model numbers of accessories and optional accessories are subject to change without prior notice.

## Bottom View

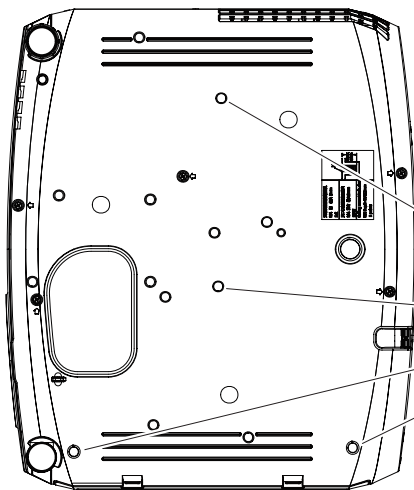

Model No. of ceiling mount bracket:

- ① ET-PKL100S (for low ceilings)  
ET-PKV400B (Projector mount bracket)
- ② ET-PKL100H (for high ceilings)  
ET-PKV400B (Projector mount bracket)

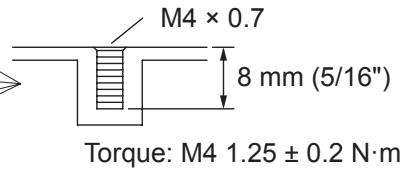

# Index

- A**
- Accessing from the web browser ..... 84
  - Accessories ..... 20
  - <AC IN> terminal ..... 23
  - Adjusting adjustable feet ..... 31
  - [ADVANCED MENU] ..... 54
  - [AMX D.D.] ..... 82
  - [ASPECT] ..... 62
  - Attaching the Lens Cap ..... 27
  - [AUDIO SETTING] ..... 75
  - <AUTO SETUP> button
    - Projector body ..... 24
    - Remote control ..... 22, 42
  - [AUTO SETUP SETTING] ..... 68
  - <AV MUTE> button
    - Remote control ..... 22, 45
- B**
- [BACK COLOR] ..... 68
  - Basic operations by using the remote control ..... 42
  - [BRIGHTNESS] ..... 52
- C**
- CD-ROM ..... 21
  - Ceiling mount bracket safeguards ..... 117
  - [CLOCK PHASE] ..... 61
  - [CLOSED CAPTION SETTING] ..... 66
  - [COLOR] ..... 53
  - [COLOR TEMPERATURE] ..... 53
  - [COMPUTER1 INPUT SETTING] ..... 71
  - <COMPUTER 1> button
    - Remote control ..... 22, 43
  - <COMPUTER 2> button
    - Remote control ..... 22, 43
  - [COMPUTER2 SELECT] ..... 71
  - Connecting ..... 33
  - Connecting the power cord ..... 37
  - [CONTRAST] ..... 52
  - [CONTROL DEVICE SETUP] ..... 80
  - [Crestron Connected (TM)] ..... 82
- D**
- [DAYLIGHT VIEW] ..... 54
  - <DEFAULT> button
    - Remote control ..... 22, 49
  - [DIGITAL CINEMA REALITY] ..... 55
  - Dimensions ..... 116
  - [DISPLAY OPTION] ..... 65
  - [DOT CLOCK] ..... 61
  - <D.ZOOM +/-> button
    - Remote control ..... 22, 44
- E**
- [ECO MANAGEMENT] ..... 73
  - [EMULATE] ..... 74
  - <ENTER> button
    - Projector body ..... 24
    - Remote control ..... 22
- F**
- [FILTER COUNTER] ..... 77
  - [FRAME LOCK] ..... 63
  - <FREEZE> button
    - Remote control ..... 22, 44
  - <FUNCTION> button
    - Remote control ..... 22, 43
  - [FUNCTION BUTTON] ..... 74
- H**
- <HDMI 1> button
    - Remote control ..... 22, 43
  - <HDMI 2> button
    - Remote control ..... 22, 43
  - [HDMI SIGNAL LEVEL] ..... 66
- I**
- <ID ALL> button
    - Remote control ..... 22, 46
  - <ID SET> button
    - Remote control ..... 22, 45
  - [INITIALIZE] ..... 82
  - [INITIALIZE ALL] ..... 77
  - [INITIAL START UP] ..... 72
  - <INPUT SELECT> button
    - Projector body ..... 24
  - Installation mode ..... 29
  - [IRIS] ..... 54
- L**
- Lamp indicator ..... 24, 99
  - [LAMP POWER] ..... 72
  - [LANGUAGE] ..... 64
  - List of compatible signals ..... 112
- M**
- Main menu ..... 49
  - Maintenance/replacement ..... 100
  - <MENU> button
    - Projector body ..... 24
    - Remote control ..... 22
  - [MENU LOCK] ..... 79
  - [MENU LOCK PASSWORD] ..... 79
  - Menu Navigation ..... 48
  - <MUTE> button
    - Remote control ..... 22, 45
- N**
- [NAME CHANGE] ..... 81
  - [NETWORK] ..... 81
  - Network connections ..... 83
  - [NETWORK CONTROL] ..... 82
  - [NOISE REDUCTION] ..... 55
- O**
- [ON-SCREEN DISPLAY] ..... 65
  - Optional accessories ..... 21
  - [OTHER FUNCTIONS] ..... 70
  - [OVER SCAN] ..... 62
- P**
- [PASSWORD] ..... 78
  - [PASSWORD CHANGE] ..... 78
  - [PICTURE] ..... 52
  - [PICTURE MODE] ..... 52
  - PJLink protocol ..... 106
  - [POSITION] ..... 57
  - Power button
    - Projector body ..... 24
    - Remote control ..... 22
  - Power indicator ..... 24, 37
  - Powering Off the Projector ..... 40
  - Precautions for use ..... 17
  - Projecting ..... 41
  - [PROJECTION METHOD] ..... 72
  - Projector body ..... 23
  - [PROJECTOR ID] ..... 72
  - [PROJECTOR SETUP] ..... 71
  - [P-TIMER] ..... 69
  - <P-TIMER> button
    - Remote control ..... 22, 45
- R**
- Read this first! ..... 4
  - [REALTIME KEYSTONE] ..... 57
  - Remote control ..... 22
  - <RETURN> button
    - Remote control ..... 22, 49
  - [RGB/Y<sub>B</sub>P<sub>R</sub>] / [RGB/Y<sub>C</sub>C<sub>R</sub>] ..... 55
- S**
- [SHIFT] ..... 61
  - <SCREEN ADJ> button
    - Remote control ..... 22
  - [SCREEN ADJUSTMENT] ..... 57
  - [SCREEN SETTING] ..... 67
  - [SECURITY] ..... 78
  - <SERIAL IN> terminal ..... 109
  - Setting up ..... 29
  - [SHARPNESS] ..... 53
  - [SIGNAL SEARCH] ..... 68
  - Specifications ..... 114
  - [STARTUP LOGO] ..... 68
  - [STATUS] ..... 71, 82
  - Sub menu ..... 49
  - [SXGA MODE] ..... 69
- T**
- Temperature indicator ..... 24, 99
  - [TEST PATTERN] ..... 76
  - [TEXT CHANGE] ..... 79
  - [TEXT DISPLAY] ..... 79
  - [TINT] ..... 53
  - Troubleshooting ..... 104
  - [TV-SYSTEM] ..... 55
- V**
- <VIDEO> button
    - Remote control ..... 22, 43
  - <VOL +/-> button
    - Remote control ..... 22, 43
- W**
- [WIDE MODE] ..... 69
  - [WIRED LAN] ..... 81

## Disposal of Old Equipment and Batteries

### Only for European Union and countries with recycling systems



These symbols on the products, packaging, and/or accompanying documents mean that used electrical and electronic products and batteries must not be mixed with general household waste. For proper treatment, recovery and recycling of old products and used batteries, please take them to applicable collection points in accordance with your national legislation. By disposing of them correctly, you will help to save valuable resources and prevent any potential negative effects on human health and the environment.

For more information about collection and recycling, please contact your local authority. Penalties may be applicable for incorrect disposal of this waste, in accordance with national legislation.



#### **Note for the battery symbol (bottom symbol)**

This symbol might be used in combination with a chemical symbol. In this case it complies with the requirement set by the Directive for the chemical involved.

## Product Information (for Turkey only)

AEEE Yönetmeliğine Uygundur.

---

# Panasonic Connect Co., Ltd.

Web Site : <https://panasonic.net/cns/projector/>  
© Panasonic Connect Co., Ltd. 2022

---

## **Panasonic Connect North America**

Two Riverfront Plaza, Newark, NJ 07102

TEL: (877) 803 - 8492

## **Panasonic Canada Inc.**

5770 Ambler Drive, Mississauga, Ontario L4W 2T3

TEL: (905) 624 - 5010