

Operating Instructions

Wireless Manager ME6.4

Wireless Manager mobile edition 6.4

Mac

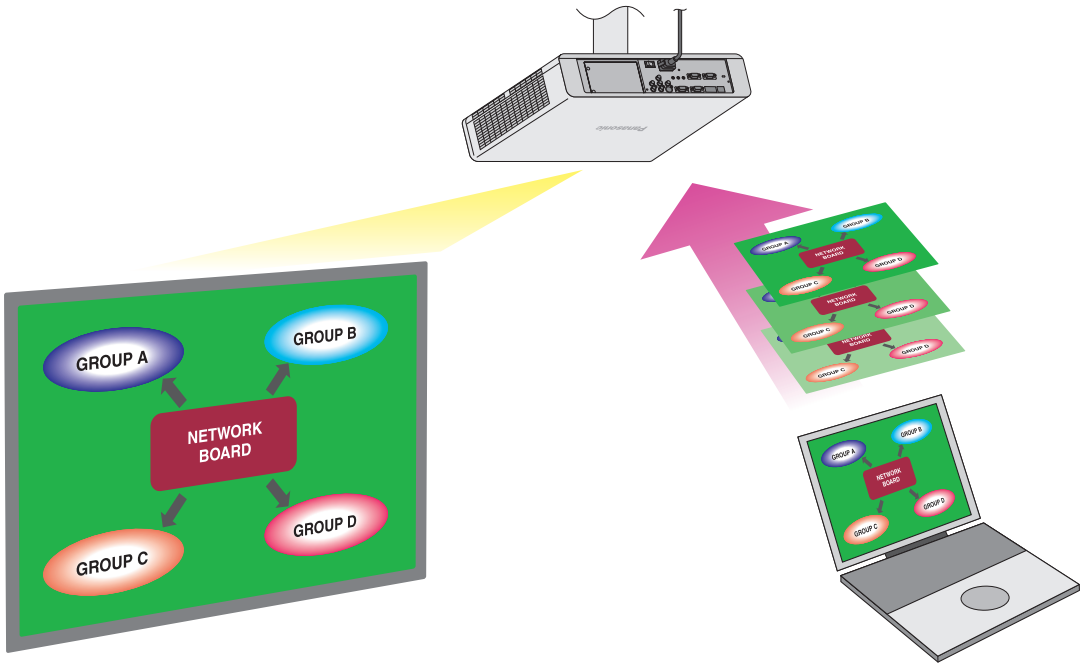

Thank you for purchasing this Panasonic product.
Before using this software, please read the instructions carefully.

Contents

Introduction

Software Licensing Agreement.....	4
Notifications and requests regarding use.....	5
Using the software	6

Preparations

Checking your computer	9
Necessary environment for computers to be connected.....	9
System requirements	10
Installing/uninstalling the software	11
Installing the software	11
Uninstalling the software.....	12
Connecting the computer to the devices	13
If the account does not have administrator privileges	13
Checking the device.....	14

Starting the Software

Starting the software.....	16
<Simple connection> screen.....	17
<Check Network ID> screen	17
<Registered Projectors> screen	18
<Find Projectors> screen.....	19

Selecting the Devices

Selecting registered devices	21
Use with the [SIMPLE], [S-DIRECT], [S-MAP], [1], [2], [3], and [4] settings.....	23
Use with the [USER] setting	25
Use with the [M-DIRECT] setting.....	28
Use with a wired LAN connection.....	30
Use with searched IP addresses	33
When a password has been set for a device	35
When a device is equipped with Content Manager	35

Displaying Images

Operating the launcher	36
Launcher	36
Adjusting the volume.....	37
Quitting the software	37
Operating the menu bar	38

Registering and Editing Devices

Registering devices and groups	39
<Register Projectors> screen	39
Changing registered names	42
Removing registered devices and groups	43
Changing registered devices and groups	44

Various Functions

Specifying areas for transmission.....	45
Automatically adjusting the projection window size	45
Restoring the default area specification window size	45
Exiting area specification	46
Setting the options	47
Live mode.....	48
Multi live mode.....	50
4-screen multi style	52
4-screen index style	53
16-screen index style	54
Setting the sender's names	55
Moderator mode	56
Multi-device live mode	57
Browser Remote Control	58
WEB control.....	59
Content Manager	60
Version information.....	60

Appendices

Glossary	61
Frequently Asked Questions	63

Software Licensing Agreement

Use of this Software is governed by the terms defined in this “Software Licensing Agreement”.
By using the software, users are deemed to have agreed to the terms of the “Software Licensing Agreement”.

● Article 1 License

The users obtain the license of the software, but the copyright or intellectual property right of the software does not transfer to the users.

● Article 2 Use by a Third Party

Licensee may not transfer or allow any third party, to use or copy the Software, whether free of charge or not.

● Article 3 Restrictions on Copying the Software

Licensee may make a single copy of the Software in whole or in part solely for backup purposes.

● Article 4 Computer

Licensee may install and use the Software on more than one computer owned or managed by Licensee.

● Article 5 Reverse Engineering, Decompiling or Disassembly

Licensee may not reverse engineer, decompile or disassemble the Software. Panasonic Connect Co., Ltd. shall not be bound by warranty for any defects in the Software caused by Licensee’s reverse engineering, decompiling or disassembly of the Software.

Furthermore, Panasonic Connect Co., Ltd. or its distributors or dealers will not be responsible for any damage to the Licensee caused by Licensee’s reverse engineering, decompiling or disassembly of the Software.

● Article 6 After-sales Service

Panasonic Connect Co., Ltd. shall undertake to notify Licensee of whether the problem is a known error in the program (“bug”), or whether the way in which the Software is to be used should be modified.

Furthermore, the Software is subject to revision without prior notice.

● Article 7 Indemnification

Panasonic Connect Co., Ltd. liability with respect to this Software is limited to the conditions defined in Article 6 herein. Panasonic Connect Co., Ltd. or any of its distributors or dealers shall not be liable for any damage suffered by Licensee, either directly or through claims from a third party, arising from or in connection with Licensee’s use of the Software. Furthermore, Panasonic Connect Co., Ltd. does not guarantee the successful operation of the software unless it is used with Panasonic displays (projectors and flat-panel displays).

● Article 8 Export Control

Licensee agrees not to export or re-export the Software to any country other than the country of purchase of the device in any form without the appropriate export licenses under the regulations of the country where Licensee resides or of any other country as may be required by such export or re-export.

Please note the following.

- Panasonic Connect Co., Ltd. hereby disclaims all liability for any damages or losses, whether suffered directly or indirectly, which have been caused by the use of or by trouble occurring in the displays (projectors or flat-panel displays).
- Panasonic Connect Co., Ltd. cannot be held liable for damages arising from data corruption or loss as a result of using the displays (projectors or flat-panel displays).
- The illustrations and screen displays given in this manual may differ from what is actually displayed.
- In general, screenshots from Mac OS X v10.11 are used to describe operations in this manual.
- The specifications of this software are subject to change without notice.

Notifications and requests regarding use

● Request Regarding Security

When using this software, security breaches of the type described below are conceivable.

- Leakage of your private information via the software
- Illegal operation of the software by a malicious third-party
- Harm to or cessation of operation of the software by a malicious third-party

Take steps to ensure that the displays (projectors and flat-panel displays) and computer used are secured and protected.

- Make sure the password is as hard to guess as possible.
- Change the password periodically.
- Panasonic Connect Co., Ltd. and its affiliated companies never directly ask customers for their password. Do not give out your password even if directly asked by a third-party representing themselves as Panasonic Connect Co., Ltd.
- Use the product in a network that is kept secure by firewall and other settings.
- Establish a password for the computer that will be used in order to restrict the users who can log in.

Security-related precautions to be followed when using wireless LAN products

The advantage of a wireless LAN is that information can be exchanged between a computer or other such equipment and an access point using radio waves as long as you are within range for radio transmissions.

On the other hand, because the radio waves can travel through obstacles (such as walls) and are available everywhere within a given range, problems of the type listed below may occur if security-related settings are not made.

- A malicious third-party may intentionally intercept and monitor transmitted data including the content of e-mail and personal information such as your ID, password, and/or credit card numbers.
- A malicious third-party may access your personal or corporate network without authorization and engage in the following types of behavior.
 - Retrieve personal and/or secret information (information leak)
 - Spread false information by impersonating a particular person (spoofing)
 - Overwrite intercepted communications and issue false data (tampering)
 - Spread harmful software such as a computer virus and crash your data and/or system (system crash)

Since most wireless LAN adapters or access points are equipped with security features to take care of these problems, you can reduce the possibility of these problems occurring when using this product by making the appropriate security settings for the wireless LAN device.

Some wireless LAN devices may not be set for security immediately after purchase. To decrease the possibility of occurrence of security problems, before using any wireless LAN devices, be absolutely sure to make all security-related settings according to the instructions given in the operation manuals supplied with them.

Depending on the specifications of the wireless LAN, a malicious third-party may be able to break security settings by special means.

Panasonic Connect Co., Ltd. asks customers to thoroughly understand the risk of using this software without making security settings, and recommends that the customer make security settings at their own discretion and responsibility.

Wireless Manager mobile edition 6.4 (referred to as “Wireless Manager ME 6.4” in this document) uses the following software programs.

A portion of this software is based in part on the work of the Independent JPEG Group.

- The illustrations and screens in this document may differ from the actual ones.
- In this document and software, “device” refers to Panasonic displays (projectors and flat-panel displays).
- Although the software's operation screens display functions, such as <Find Projectors>, the “projectors” include Panasonic displays (projectors and flat-panel displays).

Using the software

Using the software allows you to display computer images on the other devices with ease.

Memo

- Various software limitations may apply depending on the device used.
For the latest information, refer to the “List of Compatible Device Models” on the website ((<https://panasonic.net/cns/projector/download/application/>) or (<https://panasonic.net/cns/prodisplays/download/software/>)). Alternatively, if you have the CD-ROM for this software that was supplied with your projector or flat-panel display, refer to the “List of Compatible Device Models” in the CD-ROM’s application launcher.
- For a projector, the display resolution of projected images differs depending on the aspect ratio of the display device of the projector used.
 - When 4:3: Images of 1024 x 768 dots are displayed with the number of display dots of the projector.
 - When other than 4:3: Images of 1280 x 800 dots are displayed with the number of display dots of the projector.
- For a flat-panel display, images of 1280 x 800 dots are displayed with the number of display dots of the flat-panel display.

The basic steps before displaying the images are as follows.

■ Preparations

1 Turn on the device.

2 Select the network settings menu.

For projectors:

Press the <Panasonic APP> or <NETWORK/USB> button on the remote control (or the <INPUT SELECT> button on the projector).

For flat-panel displays:

Press the <INPUT> button on the remote control, and select [Panasonic APPLICATION].

3 Check the network ID of the device.

☞ “Checking the device” (page 14)

4 Install the software on the computer.

☞ “Installing the software” (page 11)

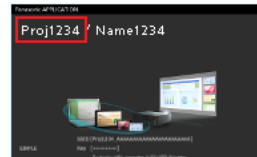

Network ID indicator
(projector image example)

■ Starting the software

5 Start the software.

☞ “Starting the software” (page 16)

When using multiple devices or specifying the IP address directly to perform connection, see (page 16), click the [Search further...] button, and perform operations in the <Find Projectors> screen (page 19).



■ Selecting the devices

6 Click the device that matches the network ID from step 3.

☞ “<Simple connection> screen” (page 17)

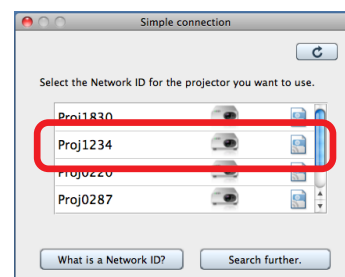

Using the software (cont.)

■ Displaying images

7 Click in the launcher.

The images on the computer screen are displayed via the device.

☞ “Launcher” (page 36)

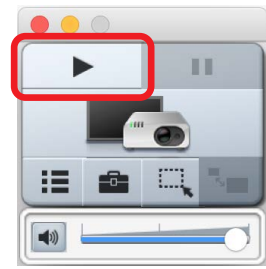

Attention

- When using the device's wireless LAN connection function, the 2.4 GHz or 5 GHz band frequencies are used. For details on precautions when using wireless LAN connections and the channels you can use for wireless LAN, refer to the operating instructions for the projector or flat-panel display.

■ < Live mode >

☞ Page 48

In this mode, the images from a single computer can be displayed on a single device.

Depending on the model, split-screen display will occur automatically based on the number of connected users.

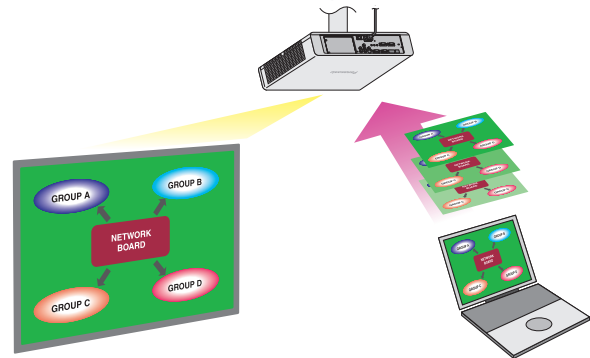

■ < Multi live mode >

☞ Page 50

In this mode, the images from multiple computers can be displayed on a single device.

This function can only be used on supported models. For details, refer to the “List of Compatible Device Models”.

● 4-screen multi style

Used for presentations involving multiple computers.



● 4-screen index style

This style is convenient in cases where you wish to focus attention on one of four presentations displayed simultaneously.

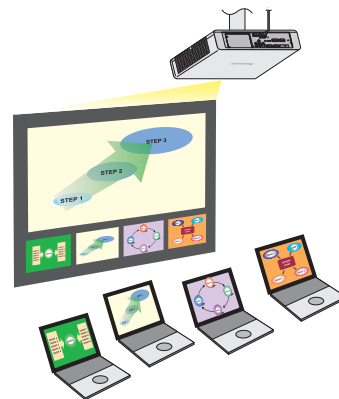

● 16-screen index style

This style is convenient in cases where you wish to display a large number of presentations as a list.

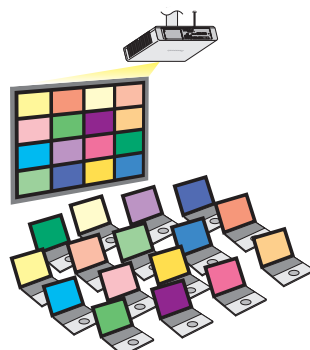

Using the software (cont.)

■ < Moderator mode >

📖 Page 56

In this mode, a moderator can use the remote control or the WEB Control screen to select which terminal to display in full screen via the device. This function can only be used on supported models. For details, refer to the “List of Compatible Device Models”.



■ < Multi-device live mode >

📖 Page 57

In this mode, the images from a single computer can be displayed on multiple devices (up to 8).

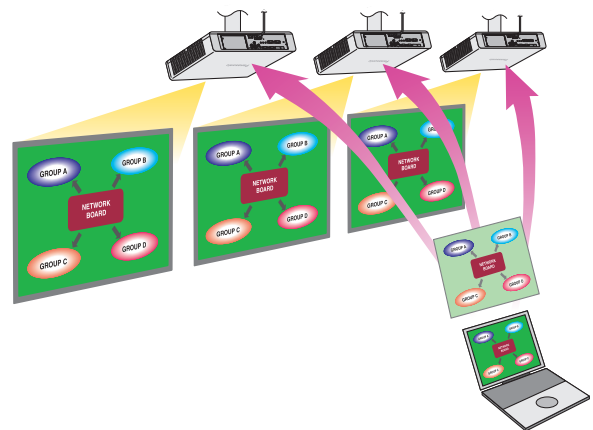

■ < Browser Remote Control >

📖 Page 58

The “Browser Remote Control” makes it possible to control devices using a variety of buttons that appear on a web browser.

Models that support Browser Remote Control: Operations identical to those on the device’s remote control can be performed via your computer’s web browser.

Models that do not support Browser Remote Control: The device can be operated via a simplified remote control screen.

■ < WEB control >

📖 Page 59

The device can be controlled using the computer’s web browser.

■ < Content Manager >

📖 Page 60

Content Manager can be opened directly from this software for devices that are equipped with Content Manager.

Checking your computer

■ Necessary environment for computers to be connected

- First, check your computer to see whether or not it has a wired LAN or a built-in wireless LAN function.
- Before connecting the device to the computer, be sure to check the following settings.
- Operation is not guaranteed for all wireless LAN adapters and built-in wireless LAN adapters.

■ Wireless LAN

▶ Check 1 Wireless LAN settings

- Is your wireless LAN adapter properly recognized?
- Is the wireless LAN adapter switched on?
- Install the wireless LAN adapter driver beforehand.

For details on how to install the driver, refer to the instructions accompanying the wireless LAN adapter.

▶ Check 2 Settings for the logged in user

- Can you log in with the administrator's privileges?

▶ Check 3 Computer settings

- When security (firewall) software and utilities for wireless LAN adapter are installed, these may prevent connection of the device.
- Has the firewall for blocking unsolicited programs been turned off or shut down?
🔗 [“Frequently Asked Questions” \(page 63\)](#)

■ Wired LAN

▶ Check 1 For wired LAN

- Is the cable properly connected?
- The specifications for cables vary depending on the system configurations. Confirm the device settings and the cable specifications.

▶ Check 2 Wired LAN settings

- Is your wired LAN adapter properly recognized?
- Is your wired LAN adapter switched on?
- Install the wired LAN adapter driver beforehand.

For details on how to install the driver, refer to the instructions accompanying the wired LAN adapter.

▶ Check 3 Computer settings

- When security (firewall) software is installed, it may prevent connection of the device.
- Has the firewall for blocking unsolicited programs been turned off or shut down?
🔗 [“Frequently Asked Questions” \(page 63\)](#)

Checking your computer (cont.)

■ System requirements

To use this software, the computer must satisfy the following requirements.

OS:	Mac OS X v10.10/10.11, macOS Sierra/High Sierra/Mojave/Catalina The Japanese, English and Chinese versions of the above operating systems are supported. Operation is not guaranteed on an OS that was not pre-installed or clean-installed.
Web browser:	For the WEB Control function, Browser Remote Control function, moderator mode, and Content Manager function: Safari 8.0/9.0/10.0/11.0/12.0/13.0
CPU:	Intel® Core™ 2 Duo or higher processor or compatible processor installed Intel Core i5 or higher recommended for image display
Memory:	1024 MB or more
Hard disk:	At least 100 MB free space (Extra free space is required to save the device information.)
LAN environment:	For connection by wired LAN: LAN terminal (10BASE-T, 100BASE-TX or 1000BASE-T) is necessary For connection by wireless LAN: Wireless LAN adapter (IEEE802.11 b/g/n/a) is necessary
Monitor screen:	High Color (16 bits) or up
Desktop area:	1024 dots × 768 dots or more 2880 dots × 1800 dots or less

Memo

- If you are logged in to a “normal” user account, sound may not be output from the computer. If sound is not output from the internal speakers, quit this software, and then make sure that [Internal Speakers] is selected in [System Preferences] → [Sound] → [Output]. If it is not selected, manually switch to [Internal Speakers].
- On a computer that has an automatic graphics switching function, image display may fail if [System Configuration] → [Energy Saving] → [Automatic Graphics Switching] is enabled. If image display fails, disable this function.
- When connecting under the IEEE802.11n standard, the wireless LAN adapter, device, and access point used must all support the 11n standard.
 - ☞ “Use with the [USER] setting” (page 25)
- When using a device with the [S-DIRECT] or [M-DIRECT] setting, use a wireless LAN adapter that supports “WPA2/AES”.
- The “App Nap” function may cause image display to stop. In such cases, disable the “App Nap” function. For details on disabling the function, see “Image display stops” in Frequently Asked Questions section.
- For a projector, the display resolution of projected images differs depending on the aspect ratio of the display device of the projector used.
 - When 4:3: Images of 1024 x 768 dots are displayed with the number of display dots of the projector.
 - When other than 4:3: Images of 1280 x 800 dots are displayed with the number of display dots of the projector.
- For a flat-panel display, images of 1280 x 800 dots are displayed with the number of display dots of the flat-panel display.

Operation is not guaranteed for all computers that meet the above conditions.

Installing/uninstalling the software

■ Installing the software

1 Start the installer.

When the software CD-ROM is supplied with the device

For projectors:

- ① Insert the CD-ROM on which the software is recorded into the CD drive.
- ② Double-click “MAC” → “WMmac6.*.dmg”^{*1} in the CD-ROM drive.
- ③ “WMmac6.*”^{*1} is now mounted on the desktop.

For flat-panel displays:

- ① Insert the CD-ROM on which the software is recorded into the CD drive.
- ② Double-click “WirelessManager” → “Mac” → “WMmac6.*.dmg”^{*1} in the CD-ROM drive.
- ③ “WMmac6.*”^{*1} is now mounted on the desktop.

When the software has been downloaded from the web site

- ① Double-click the “WMmac6.*.dmg”^{*1} file that has been downloaded from the website.
- ② “WMmac6.*”^{*1} is now mounted on the desktop.

Memo

- For the latest version of the software, refer to the website ((<https://panasonic.net/cns/projector/download/application/>) or (<https://panasonic.net/cns/prodisplays/download/software/>)).
- Install the software using an account with administrator privileges.
- ^{*1} The “*” represents various version numbers.

2 Double-click “Wireless Manager” on the virtual disk that has been mounted.

3 Follow the on-screen instructions to install the software.

4 Click [Open Security Preferences].

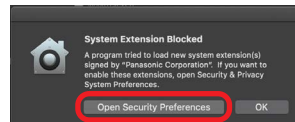

Memo

- This screen is displayed only when this application is installed for the first time on a Mac running macOS Mojave/Catalina.

5 Click [Allow].

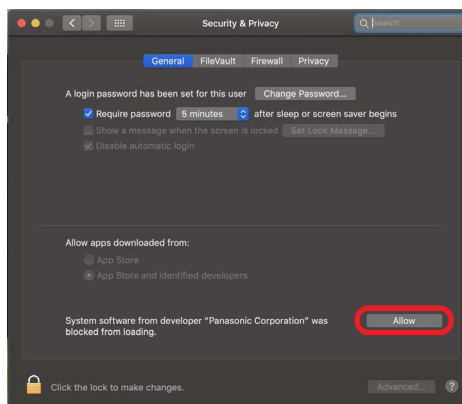

Memo

- This screen is displayed only when this application is installed for the first time on a Mac running macOS Mojave/Catalina.

6 Click [Restart].

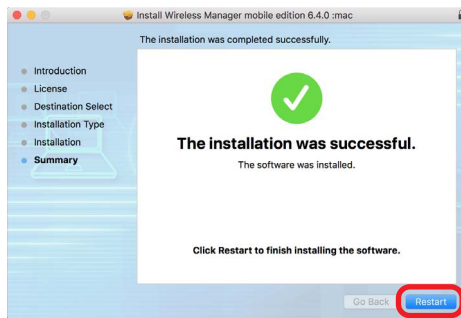

■ Uninstalling the software

1 Start the installer.

When the software CD-ROM is supplied with the device

For projectors:

- ① Insert the CD-ROM on which the software is recorded into the CD drive.
- ② Double-click "MAC" → "WMmac6.*.dmg"*1 in the CD-ROM drive.
- ③ "WMmac6.*"*1 is now mounted on the desktop.

For flat-panel displays:

- ① Insert the CD-ROM on which the software is recorded into the CD drive.
- ② Double-click "WirelessManager" → "Mac" → "WMmac6.*.dmg"*1 in the CD-ROM drive.
- ③ "WMmac6.*"*1 is now mounted on the desktop.

When the software has been downloaded from the web site

- ① Double-click the "WMmac6.*.dmg"*1 file that has been downloaded from the website.
- ② "WMmac6.*"*1 is now mounted on the desktop.

Memo

- For the latest version of the software, refer to the support information on the website ((<https://panasonic.net/cns/projector/download/application/>) or (<https://panasonic.net/cns/prodisplays/download/software/>)).
- Install the software using an account with administrator privileges.
- *1 The "*" represents various version numbers.

2 Double-click "WMUninstaller" on the virtual disk that has been mounted.

- With this operation, the driver used for the sound is uninstalled.

3 Drag and drop from the installation location to the Trash.

Wireless Manager

4 Select "Empty trash..." from the "Finder" menu.

- With this operation, the software is uninstalled.

Memo

- If only the driver used for the sound has been uninstalled, the sound will no longer be output.
- *1 The "*" represents various version numbers.

Connecting the computer to the devices

There are 8 ways to connect the computer to the devices.

Use with the [SIMPLE] setting

This is used for easy wireless communication between the device and a terminal (computer, tablet, smartphone, or other mobile device).

📖 Page 23

Use with the [S-DIRECT] setting

This is used for easy wireless communication between the device and a computer.

📖 Page 23

Use with the [S-MAP] setting

This is used for a device model that does not support [S-DIRECT].

📖 Page 23

Use with the [1] to [4] settings

This is used for a device model that does not support [S-DIRECT] or [S-MAP].

This is also used when using multiple devices at the same time.

📖 Page 23

Use with the [M-DIRECT] setting

This is used when specifying a particular network and security key to communicate with the device.

📖 Page 28

Use with the [USER] setting

This is used when using an existing network or access point for communication.

This is also used when using multiple devices at the same time.

📖 Page 25

Use with a wired LAN connection

This is used when the device and computer are connected using a LAN cable.

This is also used when using multiple devices at the same time.

📖 Page 30

Use with searched IP addresses

This is used when communicating with the device using the IP address search function.

📖 Page 33

If the account does not have administrator privileges

If you logged onto the computer using an account without administrator privileges, devices whose wireless LAN connection setting is set to [SIMPLE], [S-DIRECT], [S-MAP], [1], [2], [3], or [4] cannot be used.

- Depending on the device, the wireless LAN connection setting may be referred to as the network number.

Devices that can be used

- 📖 “Use with the [USER] setting” (page 25)
- 📖 “Use with the [M-DIRECT] setting” (page 28)
- 📖 “Use with a wired LAN connection” (page 30)
- 📖 “Use with searched IP addresses” (page 33)

Memo

- The network settings of the computer must be established using an account with administrator privileges.
- Administrator privileges are required to install this software.

Checking the device

Device power

Turn on the device.

Setting the input

For projectors

Press the <Panasonic APP> or <NETWORK/USB> button on the remote control (or the <INPUT SELECT> button on the projector), and switch the input to [Panasonic APPLICATION] or [NETWORK].
A standby screen is displayed in the image projected by the projector.

For flat-panel displays

Press the <INPUT> button on the remote control, and select [Panasonic APPLICATION].
A standby screen is displayed on the flat-panel display.

Device check

Check the device's wireless LAN connection method, projector name or display name, and network ID.
The locations where this information is displayed may vary depending on the device model.

For devices that display the standby screen (projector image example)

The standby screen may not appear even for devices that display the screen if another user is already displaying an image, if multi live mode (page 50) is being used in the 4-screen or 16-screen index style, or if moderator mode (page 56) is enabled.

For projectors, you can check the network ID by pressing the AUTOSSETUP button.

For flat-panel displays, you can check the network ID by selecting [Network status] in [Network settings].

Example of standby screen display.

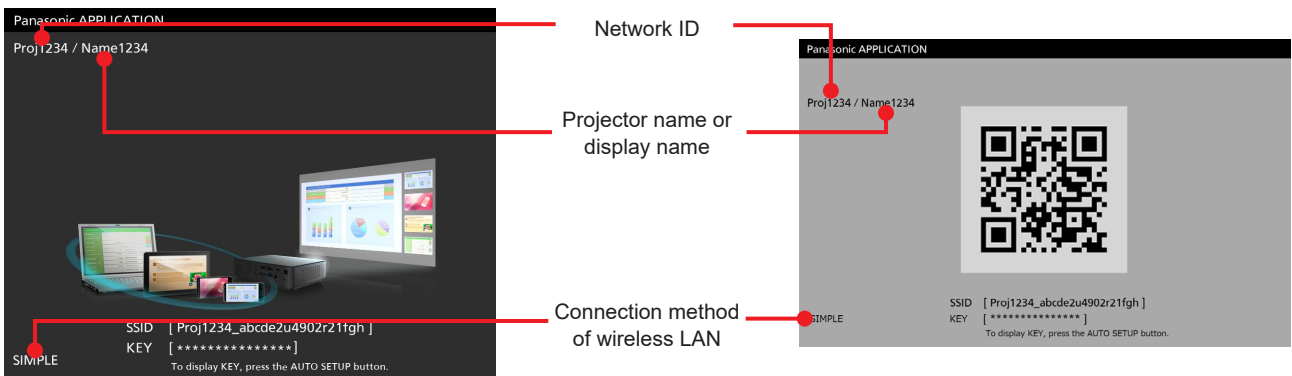

For devices that do not display the standby screen (projector image example)

Example of input guidance display.

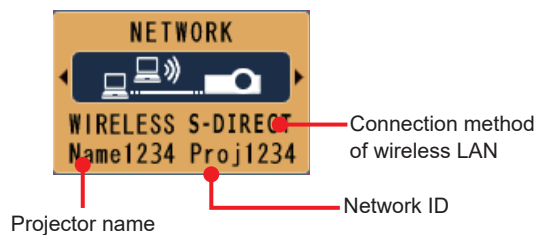

INPUT	NETWORK
SIGNAL NAME	XGA-A1
MEMORY NO	A1
WIRELESS LAN	S-DIRECT
PROJECTOR NAME	NAME1234
NETWORK ID	Proj1234

Checking the device (cont.)

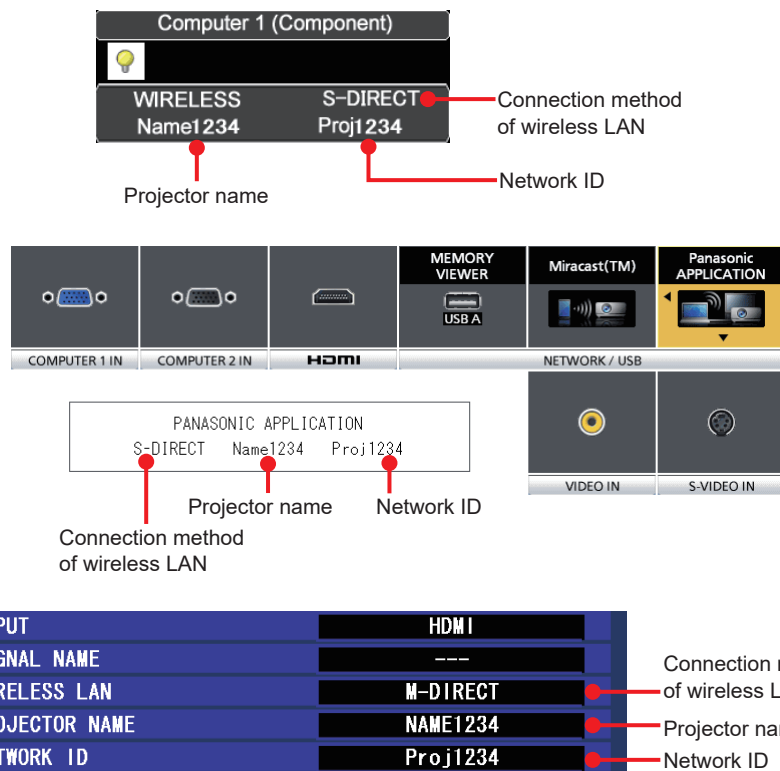

- If the input guidance does not appear, press the <MENU> button on the projector, and in the menu that is displayed, select [DISPLAY OPTION] → [INPUT GUIDE] → [ON] or [DETAILED].

■ Checking the network status

The network setting information can be checked using the device's menu.

- Press the <MENU> button on the projector, and in the menu that is displayed, select [NETWORK] → [NETWORK STATUS] to check the detailed network setting information.
- Press the <SETUP> button on the flat-panel display's remote control, and in the menu that is displayed, select [Network settings] → [Network status] to check the detailed network setting information.
- To easily connect to the computer with a wireless LAN, the [SIMPLE] or [S-DIRECT] setting is useful.
 - ☞ "Use with the [SIMPLE], [S-DIRECT], [S-MAP], [1], [2], [3], and [4] settings" (page 23)

📝 Memo 📝

- The method for configuring the wireless LAN network settings differs depending on the projector or flat-panel display.
 - ☞ Operating instructions for the projector or flat-panel display (wireless LAN settings)

Starting the software

To start the software:

Click  on the Dock or installation destination.
Wireless Manager

When the software starts, the <Simple connection> screen and launcher appear.

Switch the screen to use to connect according to the device's wireless LAN connection method and the method for connecting with the device.

■ Using the <Simple connection> screen

- When using the [SIMPLE], [S-DIRECT], [S-MAP], [USER], and [M-DIRECT] settings with a single device

■ Procedure

Make the connection using the <Simple connection> screen (page 17).

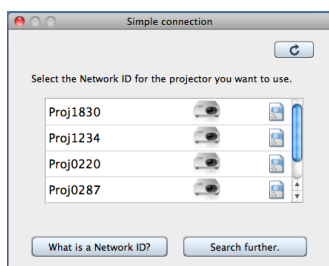

When using the [USER] and [M-DIRECT] settings, you must make network settings on the computer according to the device's wireless LAN settings (pages 25 - 29).

■ Using the <Find Projectors> screen

- When using the [SIMPLE], [S-DIRECT], [S-MAP], [USER], [1] to [4], and [M-DIRECT] settings with a single device
- When using the [USER] and [1] to [4] settings with multiple devices
- When using the [USER] and [M-DIRECT] settings with an IP search

■ Procedure

Click [Search further...] in the <Simple connection> screen and work from the <Find projectors> screen (page 19).

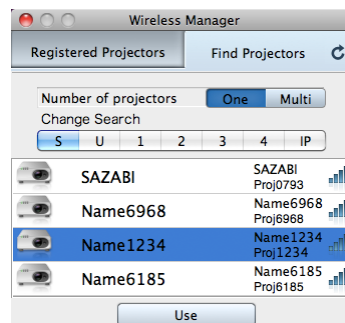
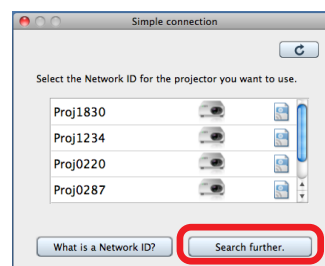

Memo

- When the [A simple connection screen is displayed at startup] checkbox is selected in the option settings, the <Simple connection> screen is displayed when the software starts.
☞ "Setting the options" (page 47)
- If the [A simple connection screen is displayed at startup] checkbox is not selected in the option settings and not a single device has been registered, the <Register Projectors> screen will appear when the software starts.
☞ "Setting the options" (page 47)

Starting the software (cont.)

■ <Simple connection> screen

You can display a computer screen via the device quickly through simple operations in the screen that appears after the software starts. You can also create shortcut files for connecting to the device or displaying images via the device.

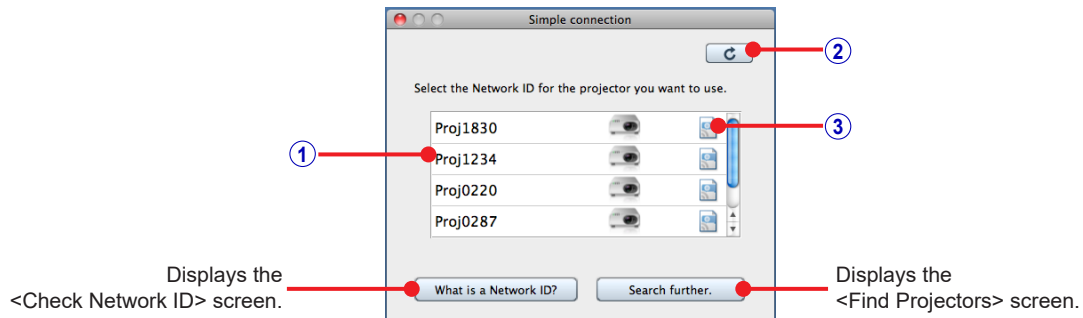

① Network ID

Consists of "Proj" followed by a 4-digit number used for identifying the device.

☞ "Checking the device" (page 14)

② Update button

Refresh the device search results.

③ Shortcut file creation button

Create a shortcut file for the respective device in the specified folder. You can create the following two types of shortcuts.

- Creating shortcut files for connection



Double-clicking this icon automatically connects to the device that was selected during creation.

- Creating shortcut icons for display



Double-clicking this icon automatically displays images via the device that was selected during creation.

■ <Check Network ID> screen

This screen shows the network ID verification method.

To open the <Check Network ID> screen, click [What is a Network ID?] in the <Simple connection> screen.

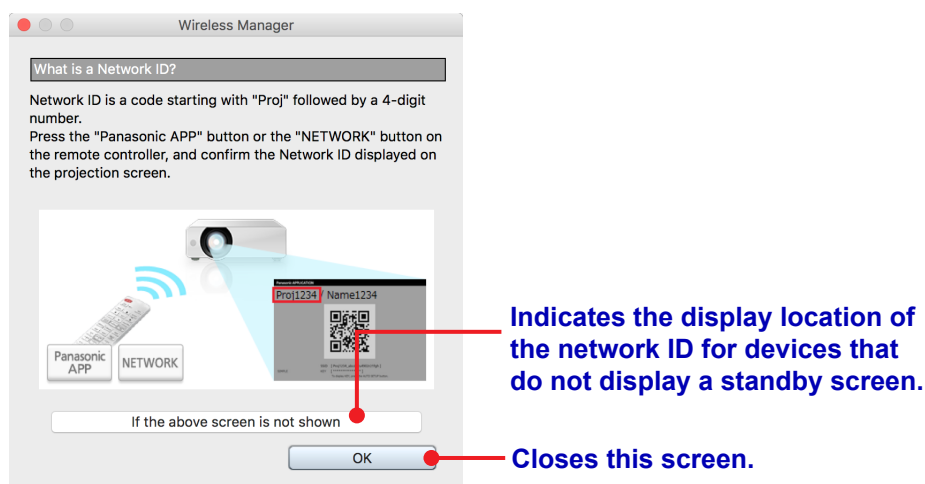

■ <Registered Projectors> screen

Registering the devices allows you to display the computer screen via the devices quickly. Up to four groups, each consisting of either a single device or multiple devices, can be registered.
 ☞ “Registering devices and groups” (page 39)

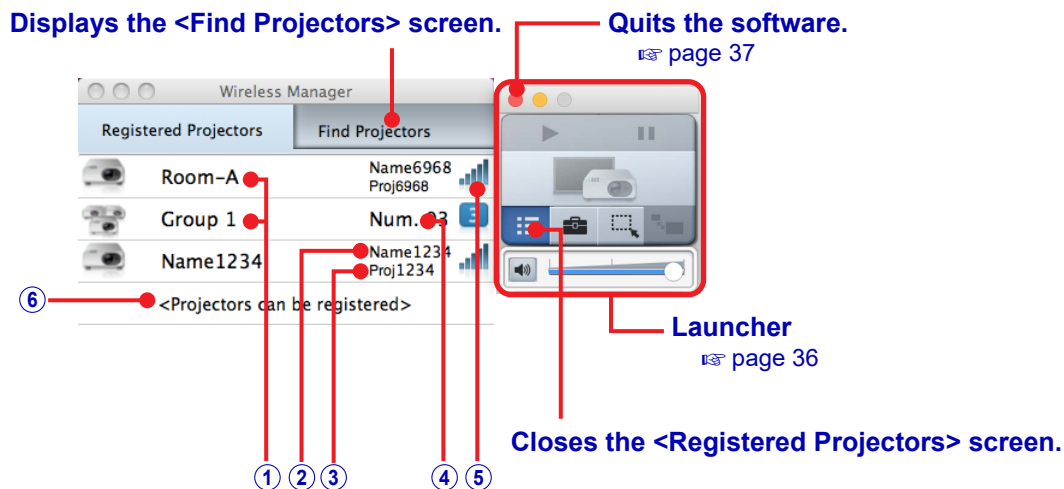

① Registered name

Displays the name of the device or group that has been registered in the software.
 ☞ “Changing registered names” (page 42)

② Projector name or display name

Displays the name that has been configured on the device. However, if the [SIMPLE] wireless LAN setting is configured, “SIMPLE” will be displayed instead of the name that is configured on the device.
 ☞ “Checking the device” (page 14)

③ Network ID

Consists of “Proj” followed by a 4-digit number used for identifying the device.
 ☞ “Checking the device” (page 14)

④ Number registered

Indicates the number of the devices comprising the group. When registering a group, this number is displayed instead of the projector name or display name and network ID.

⑤ Network

Indicates the wireless LAN connection method when the device was registered.



[SIMPLE], [S-DIRECT], or [S-MAP]
 This indicates the signal strength level.

--

[SIMPLE], [S-DIRECT], or [S-MAP] was specified during registration, but it cannot be found.

1 to 4

[1] to [4]

U

[WIRED LAN], [M-DIRECT], [USER], [IP]

⑥ Unregistered area

[<Projectors can be registered>] is displayed if there is space for additional device registration. When this area is clicked, the display switches to the <Register Projectors> screen.

Memo

- If no devices have been registered, devices and groups will not be displayed on the <Registered Projectors> screen.
- When the mouse cursor is placed over “Number registered”, the projector names, display names, and network IDs of all the devices that have been registered are displayed in a popup window.

■ <Find Projectors> screen

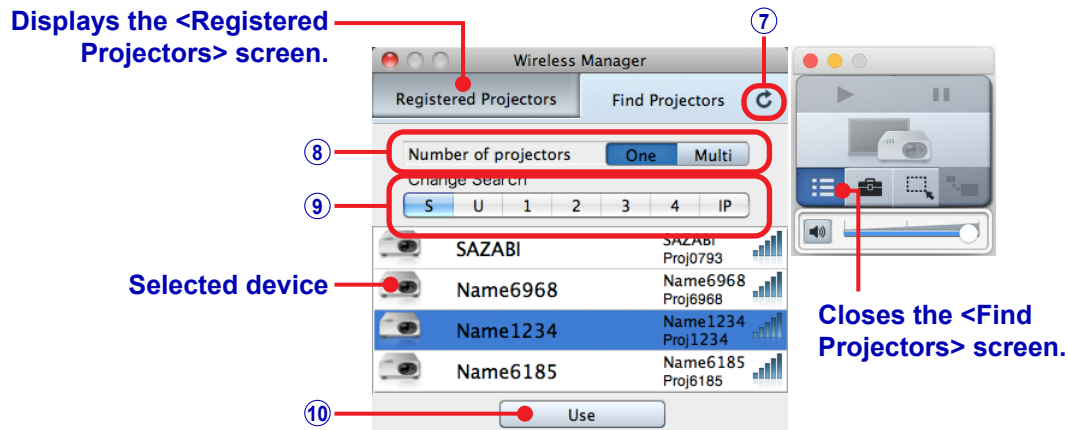

⑦ Update button

Refresh the device search results.

⑧ [Number of projectors] buttons

Click the **One** or **Multi** button to switch the number of the devices to be used at the same time. When **Multi** is selected, **S** cannot be clicked in the [Change Search] buttons.

⑨ [Change Search] buttons

Click these buttons to search for and display devices that match the corresponding wireless LAN connection method. Check the wireless LAN connection method of the device to be used, and click the corresponding button to switch to it.

Button	Devices searched
<input type="button" value="S"/> [SIMPLE] [S-DIRECT] [S-MAP]	This searches for devices whose wireless LAN connection has been set to [SIMPLE], [S-DIRECT], or [S-MAP]. This is useful when you want use a device immediately without even configuring the computer's network. It is not possible to display the images via multiple devices simultaneously. ⓘ "Use with the [SIMPLE], [S-DIRECT], [S-MAP], [1], [2], [3], and [4] settings" (page 23)
<input type="button" value="U"/> [USER] [M-DIRECT] [WIRED LAN]	This searches for devices whose wireless LAN connection has been set to [USER] or [M-DIRECT], or for devices connected via wired LAN. ⓘ "Use with the [USER] setting" (page 25) ⓘ "Use with the [M-DIRECT] setting" (page 28) ⓘ "Use with a wired LAN connection" (page 30)
<input type="button" value="1"/> to <input type="button" value="4"/>	These search for devices whose wireless LAN connection has been set to [1] to [4]. ⓘ "Use with the [SIMPLE], [S-DIRECT], [S-MAP], [1], [2], [3], and [4] settings" (page 23)
<input type="button" value="IP"/>	This searches for devices using a specified IP address. ⓘ "Use with searched IP addresses" (page 33)

Starting the software (cont.)

⑩ [Use] button

Click this button to enable display of the images via the selected device.

Memo

- If you logged onto the computer using an account without administrator privileges, devices whose wireless LAN connection setting is set to [SIMPLE], [S-DIRECT], [S-MAP], [1], [2], [3], or [4] cannot be used.
- WEP (Wired Equivalent Privacy) is not applied to wireless LAN connection [1].
WEP is applied to wireless LAN connections [2] to [4], so set the device's wireless LAN connection to [2] to [4] when more security is required.
- Even when [ENCRYPTION] is set to [NONE] on a device whose wireless LAN connection is [1] or [USER], AES encryption has been implemented for all the wireless LAN connection methods ahead of time, so important video and audio data is protected.
- To select a device, a wireless LAN connection identical to that set on the device must be selected using the [Change Search] buttons. To check the wireless LAN connection method of a device, check the device's network menu or check the standby screen.
 ["Checking the device" \(page 14\)](#)
- For a projector, the display resolution of projected images differs depending on the aspect ratio of the display device of the projector used.
 - When 4:3: Images of 1024 x 768 dots are displayed with the number of display dots of the projector.
 - When other than 4:3: Images of 1280 x 800 dots are displayed with the number of display dots of the projector.
- For a flat-panel display, images of 1280 x 800 dots are displayed with the number of display dots of the flat-panel display.

Selecting registered devices

Select the device to use from the preregistered devices, and display the computer screen.

When a group consisting of multiple devices is selected, the computer screen can be displayed using multiple devices at the same time.

- Before proceeding, turn on the device and verify the wireless LAN connection method, projector name or display name, and network ID.
 - ☞ “Checking the device” (page 14)
 - ☞ “Registering devices and groups” (page 39)

1 Start the software (), and display the <Registered Projectors> screen.

☞ “Starting the software” (page 16)

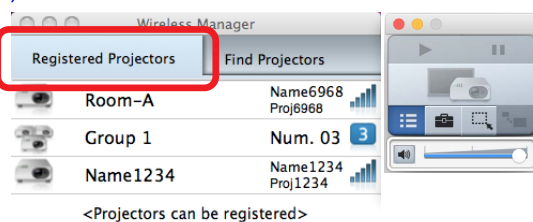

2 Click the device that matches the projector name or display name and network ID displayed on the device.



Network ID indicator
(projector image example)

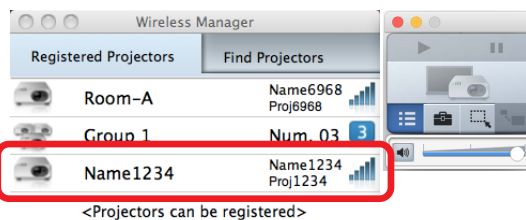

<Registered Projectors> screen display example
(screenshot of the software)

Memo

- The display locations of the projector name or display name and network ID may vary depending on the device.
 - ☞ “Checking the device” (page 14)
- If the wireless LAN setting is [SIMPLE], “SIMPLE” will be displayed instead of the projector name or display name in the registration list screen.
- When the mouse cursor is placed over “Number registered”, the projector names, display names, and network IDs of all the devices that have been registered are displayed in a popup window.

Selecting registered devices (cont.)

When the device is ready to display the images, launcher operations are enabled.

☞ “Launcher” (page 36)

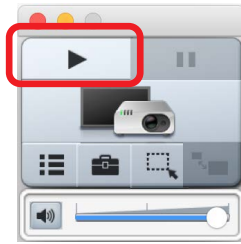

- If a confirmation screen for network settings change appears, click [Yes].

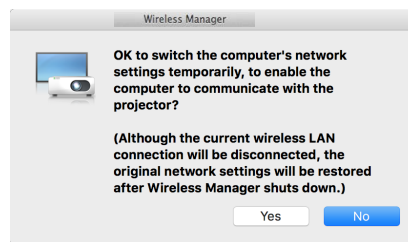

- If administrator privileges are required, enter the administrator's name and password.



Use with the [SIMPLE], [S-DIRECT], [S-MAP], [1], [2], [3], and [4] settings

Select a device whose wireless LAN connection method is set to [SIMPLE], [S-DIRECT], [S-MAP], [1], [2], [3], or [4], and display the computer screen.

- The [SIMPLE], [S-DIRECT], and [S-MAP] settings are useful for easy connection to the computer via wireless LAN.
- Before proceeding, turn on the device and verify the wireless LAN connection method, projector name or display name, and network ID.

☞ “Checking the device” (page 14)

1 Start the software (), and display the <Simple connection> screen.

☞ “Starting the software” (page 16)

When selecting from the <Simple connection> screen with the [SIMPLE], [S-DIRECT], or [S-MAP] setting

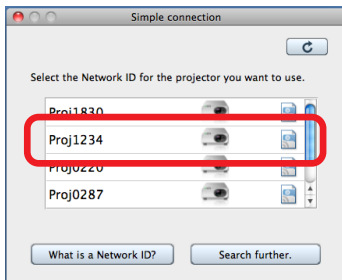

Click the device in the list that matches the network ID displayed on the device.

When the device is ready to display the images, launcher operations are enabled.

Steps 2 and beyond of the procedure can be skipped.

When selecting from the <Find projectors> screen with the [SIMPLE], [S-DIRECT], [S-MAP], [1], [2], [3], or [4] setting



Click [Search further...] to display the <Find projectors> screen.

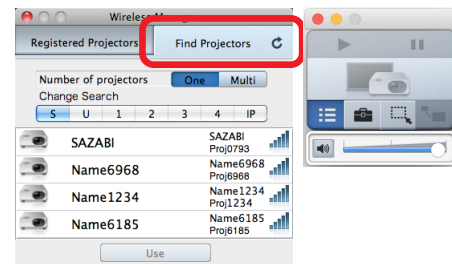

Afterwards, proceed to step 2 of the procedure.

2 Click the **One** or **Multi** button for [Number of projectors] based on the number of devices to be used, and click the [Change Search] button that corresponds to the wireless LAN connection method displayed on the device.

If the wireless LAN connection method is [SIMPLE], [S-DIRECT], or [S-MAP], click **S**. If it is [1], [2], [3] or [4], click the button with the same number.

- When the <Find Projectors> screen is displayed, **One** is selected.



Network ID indicator
(projector image example)

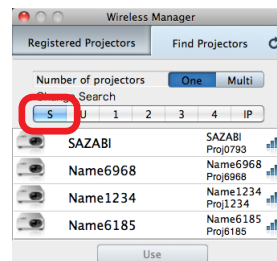

<Find Projectors> screen display example
(screenshot of the software)

3 Click the device that matches the projector name or display name and network ID displayed on the device.

When using multiple devices at the same time, select all the devices to be used.



Network ID indicator
(projector image example)

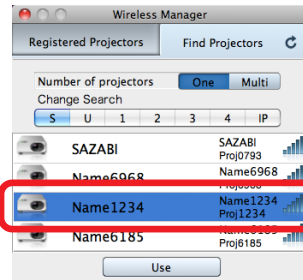

<Find Projectors> screen display example
(screenshot of the software)

4 Click [Use].

When the device is ready to display the images, launcher operations are enabled.

☞ "Launcher" (page 36)

Memo

- If a confirmation screen for network settings change appears, click [Yes].
☞ Page 22
- The display locations of the projector name or display name and network ID may vary depending on the device.
☞ "Checking the device" (page 14)
- When multiple devices have been selected for use, select the **Multi** button for [Number of projectors].
Up to 8 devices can be used at the same time.
☞ Page 19

Use with the [USER] setting

Select a device whose wireless LAN connection method is set to [USER], [USER1], [USER2], or [USER3], and display the computer screen.

- Before proceeding, turn on the device and verify the projector name or display name and the network ID.
 - ☞ “Checking the device” (page 14)

■ Device settings

1 Configure the network settings for the device.

- ① Select the network menu.

For projectors:

On the projector menu screen, select [USER] (or [USER1], [USER2], or [USER3]) for the wireless LAN connection method in [Network] → [WIRELESS LAN].

For flat-panel displays:

Press the [SET UP] button on the remote control, and select [Network status] → [Wireless LAN] → [USER1] (or [USER2] or [USER3]).

- ② Set the network.

☞ Operating instructions for the projector or flat-panel display

[USER] setting:

When the SSID search screen appears, select the SSID to which you want to connect.

Authentication/encryption settings are required when an SSID marked with a lock icon is selected.

[USER1], [USER2], and [USER3] settings:

When the network information entry screen appears, enter the information of the SSID to which you want to connect.

For an AD HOC connection (“Glossary” page 61) (connection using the factory default settings)	
SSID	*1
DHCP	Off
IP address	192.168.11.100
Subnet mask	255.255.255.0
Default gateway	192.168.11.1
Mode	AD HOC
Authentication	Open
Encryption	None
Channel	11

For a connection via an access point (DHCP) (“Glossary” page 61)	
SSID	Enter the name of the access point to be connected.
DHCP	On
Mode	INFRASTRUCTURE
Authentication	Enter settings to match the access point to be connected.
Encryption	
Channel	

*1 For projectors: Panasonic Projector
For flat-panel displays: Panasonic Display

- Before selecting any other settings, check them with the network administrator.

■ Computer settings

2 Configure the network settings for the computer according to the device's settings.

If the device's settings are still in their factory default state, set the computer's DHCP function to “On”.

- Before setting the computer's network settings, consult the network administrator.

Use with the [USER] setting (cont.)

3 Connect the computer to the network that has been set for the devices.

Click  at the far right of the menu bar, and connect to the network whose SSID has been set for the device.

Memo

- If the network cannot be found, refer to the operating instructions of the wireless LAN adapter.
- If the wireless LAN connection cannot be established via the access point even though the device settings have been established correctly, contact the manufacturer of the access point.

■ Selecting devices

4 Start the software (), and display the <Simple connection> screen.

 “Starting the software” (page 16)

When using one device with the <Simple connection> screen

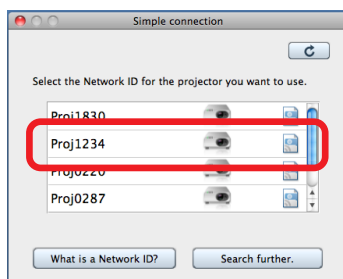

Click the device in the list that matches the network ID displayed on the device.

When the device is ready to display the images, launcher operations are enabled.

Steps 5 and beyond of the procedure can be skipped.

When using one or more devices with the <Find projectors> screen

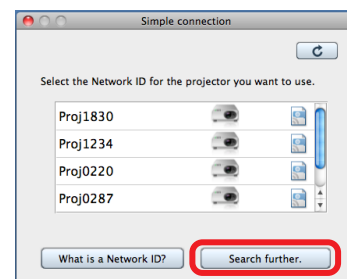

Click [Search further...] to display the <Find projectors> screen.

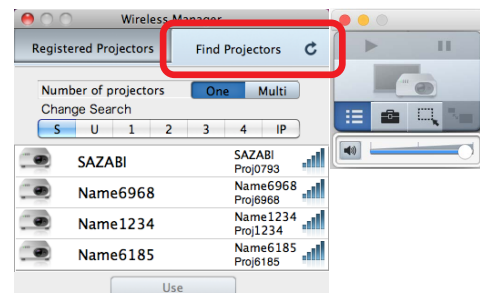

Afterwards, proceed to step 5 of the procedure.

5 Click the or button for [Number of projectors] based on the number of devices to be used, and click the button for [Change Search].

Use with the [USER] setting (cont.)

6 Click the device that matches the projector name or display name and network ID displayed on the device.

When using multiple devices at the same time, select all the devices to be used.



Network ID indicator
(projector image example)

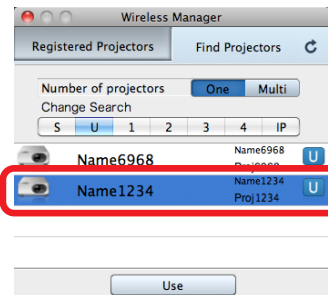

<Find Projectors> screen display example
(screenshot of the software)

- If the device cannot be found even though the network settings have been configured correctly, see “Use with searched IP addresses” (page 33).

7 Click [Use].

When the device is ready to display the images, launcher operations are enabled.

☞ “Launcher” (page 36)

Memo

- Before setting the computer's network settings, consult the network administrator.
- The display locations of the projector name or display name and network ID may vary depending on the device.
☞ “Checking the device” (page 14)
- When multiple devices have been selected for use, select the **Multi** button for [Number of projectors].
Up to 8 devices can be used at the same time.
☞ Page 19

Use with the [M-DIRECT] setting

Select a device whose wireless LAN connection method is set to [M-DIRECT], and display the computer screen. The device and computer can be connected in infrastructure mode even if a separate access point is not installed because the device becomes a simple access point.

☞ “Infrastructure Mode” (page 61)

- Before proceeding, turn on the device and verify the projector name or display name and the network ID.

☞ “Checking the device” (page 14)

■ Device settings

1 Configure the network settings for the device.

- ① Select the network menu.

For projectors:

On the menu screen, select [NETWORK] → [WIRELESS LAN] → [M-DIRECT].

For flat-panel displays:

Press the [SET UP] button on the remote control, and select [Network status] → [Wireless LAN] → [M-DIRECT].

- ② Set the network.

☞ Operating instructions for the projector or flat-panel display

Factory settings	
SSID	M-DIRECT + last 4 digits of network ID
IP address	192.168.12.100
Subnet mask	255.255.255.0
Channel	1
Key	M-DIRECT + last 4 digits of network ID Example: “M-DIRECT1234”

Attention

- Before selecting any other settings, consult the network administrator.
- If the [Key] setting is left in its factory default state, there is a risk of information being leaked by a third party. Be absolutely sure to change it.

■ Computer settings

2 Configure the network settings for the computer according to the device's settings.

If the device's settings are still in their factory default state, set the computer's DHCP function to “On”.

- Before setting the computer's network settings, check them with the network administrator.

3 Connect the computer to the network that has been set for the devices.

Click  at the far right of the menu bar, and connect to the network whose SSID has been set for the device.

Use with the [M-DIRECT] setting (cont.)

■ Selecting devices

4 Start the software (), and display the <Simple connection> screen.

☞ “Starting the software” (page 16)

When using one device with the <Simple connection> screen

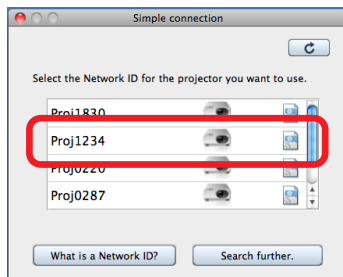

Click the device in the list that matches the network ID displayed on the device.

When the device is ready to display the images, launcher operations are enabled.

Steps 5 and beyond of the procedure can be skipped.

When using one device with the <Find projectors> screen

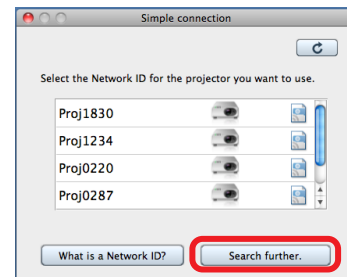

Click [Search further...] to display the <Find projectors> screen.

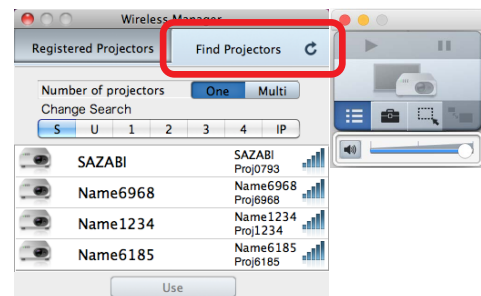

Afterwards, proceed to step 5 of the procedure.

5 Click the **One** buttons for [Number of projectors], and click the **U** buttons for [Change Search].

6 Click the device that matches the projector name or display name and network ID displayed on the device.

When using multiple devices at the same time, select all the devices to be used.



Network ID indicator
(projector image example)

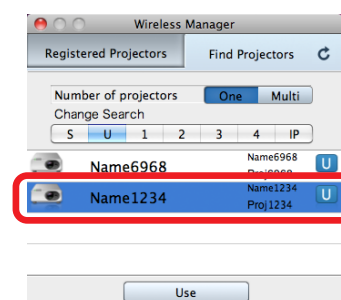

<Find Projectors> screen display example
(screenshot of the software)

- If the device cannot be found even though the network settings have been configured correctly, see “Use with searched IP addresses” (page 33).

7 Click [Use].

When the device is ready to display the images, launcher operations are enabled.

☞ “Launcher” (page 36)

Memo

- Before setting the computer's network settings, consult the network administrator.
 - The display locations of the projector name or display name and network ID may vary depending on the device.
- ☞ “Checking the device” (page 14)

Use with a wired LAN connection

Select a device connected via wired LAN, and display the computer screen.

- Before proceeding, turn on the device and verify the projector name or display name and the network ID.
🔗 “Checking the device” (page 14)

■ Device settings

1 Configure the network settings for the device.

- ① Select the network menu.
For projectors:
On the menu screen, select [NETWORK] → [WIRED LAN].
For flat-panel displays:
Press the [SET UP] button on the remote control, and select [Network status] → [Wired LAN].
- ② Set the network.
🔗 Operating instructions for the projector or flat-panel display

Factory settings	
DHCP	Off
IP address	192.168.10.100
Subnet mask	255.255.255.0
Default gateway	192.168.10.1

■ Computer settings

2 Change the TCP/IP setting.

- ① Select [System Preferences] → [Network].
- ② Click “Ethernet” on the connection list.
- ③ Change [Configure IPv4] to “Manually”.

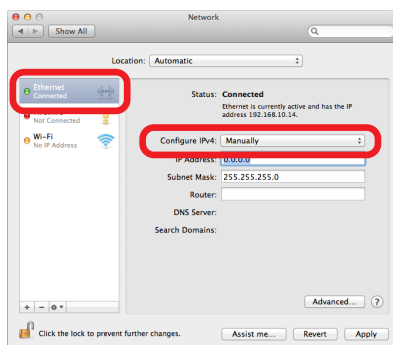

3 Configure the network settings for the computer according to the device's settings.

Enter the values in the [IP Address], [Subnet Mask], and [Router] boxes.

- Before setting the computer's network settings, consult the network administrator.

When connecting to a device whose network settings are set to factory defaults	
IP address	192.168.10.101
Subnet mask	255.255.255.0
Router	192.168.10.1

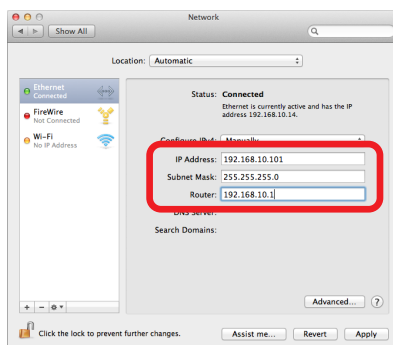

Use with a wired LAN connection (cont.)

■ Selecting devices

4 Start the software (), and display the <Simple connection> screen.

☞ “Starting the software” (page 16)

When using one device with the <Simple connection> screen

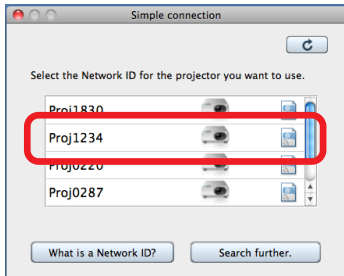

Click the device in the list that matches the network ID displayed on the device.

When the device is ready to display the images, launcher operations are enabled.

Steps 5 and beyond of the procedure can be skipped.

When using one or more devices with the <Find projectors> screen

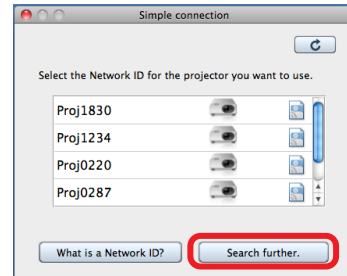

Click [Search further...] to display the <Find projectors> screen.

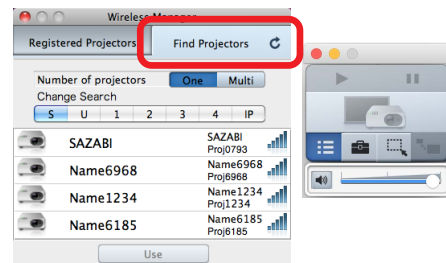

Afterwards, proceed to step 5 of the procedure.

5 Click the One or Multi button for [Number of projectors] based on the number of devices to be used, and click the button for [Change Search].

6 Click the device that matches the projector name or display name and network ID displayed on the device.

When using multiple devices at the same time, select all the devices to be used.



Network ID indicator
(projector image example)

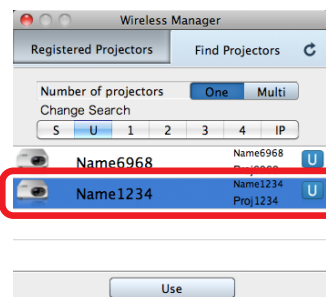

<Find Projectors> screen display example
(screenshot of the software)

- If the device cannot be found even though the network settings have been configured correctly, see “Use with searched IP addresses” (page 33).

Use with a wired LAN connection (cont.)

7 Click [Use].

When the device is ready to display the images, launcher operations are enabled.

☞ “Launcher” (page 36)

Memo

- Before setting the computer's network settings, consult the network administrator.
- The display locations of the projector name or display name and network ID may vary depending on the device.
☞ “Checking the device” (page 14)
- When multiple devices have been selected for use, select the **Multi** button for [Number of projectors].
Up to 8 devices can be used at the same time.
☞ Page 19

Use with searched IP addresses

This searches for devices whose IP addresses are entered directly.

- The device and computer must already be connected to a network on which communication is enabled. For details, check with the network administrator.
- Before proceeding, turn on the device and display the standby screen.
☞ “Checking the device” (page 14)

1 Start the software (), and display the <Simple connection> screen.

☞ “Starting the software” (page 16)

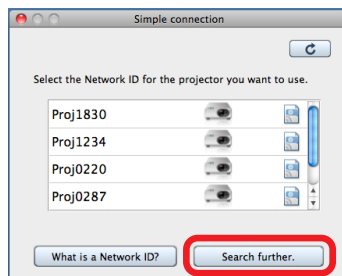

Click [Search further...] to display the <Find projectors> screen.

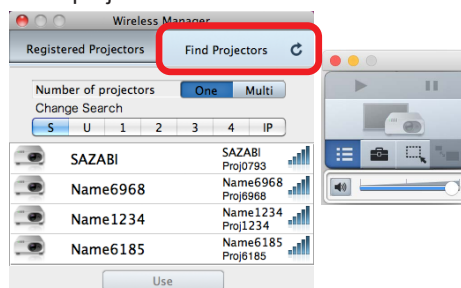

2 Click the **One** or **Multi** button for [Number of projectors] based on the number of devices to be used, and click the **IP** button for [Change Search].

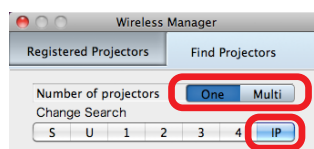

■ When communicating with one device

3 Enter the IP address of the device to be used, and click .

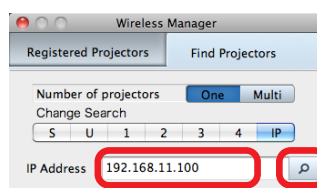

Use with searched IP addresses (cont.)

4 After verifying the projector name or display name and network ID of the device that was found, click [Use].

When the device is ready to display the images, launcher operations are enabled.

☞ “Launcher” (page 36)



Network ID indicator
(projector image example)

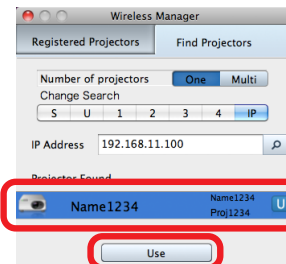

<Find Projectors> screen display example
(screenshot of the software)

Memo

- The display locations of the projector name or display name and network ID may vary depending on the device.
☞ “Checking the device” (page 14)

■ When communicating with multiple devices

3 Click [Add], enter the IP addresses of all the devices to be used, and click [Search].

- To delete an entered IP address, select the IP address to be deleted, and click [Remove].

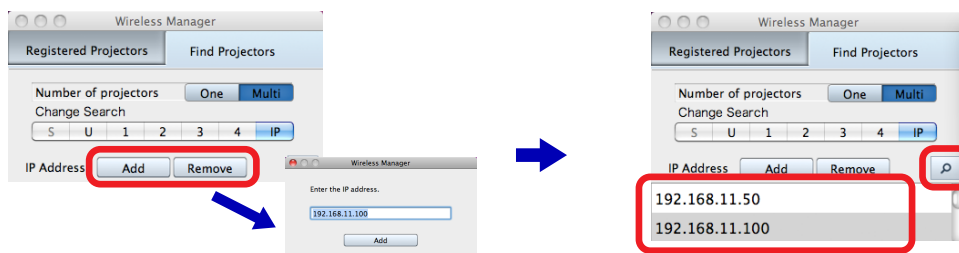

4 After verifying the projector names or display names and network IDs of the devices that were found, click [Use].

When the devices are ready to display the images, launcher operations are enabled.

☞ “Launcher” (page 36)



Network ID indicator
(projector image example)

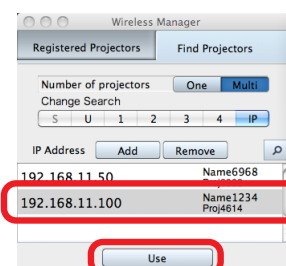

<Find Projectors> screen display example
(screenshot of the software)

Memo

- The display locations of the projector name or display name and network ID may vary depending on the device.
☞ “Checking the device” (page 14)
- When multiple devices have been selected for use, select the **Multi** button for [Number of projectors].
Up to 8 devices can be used at the same time.
☞ Page 19

When a password has been set for a device

When connecting to a device for which a network password has been set, the <Enter Password> screen will appear. Enter the network password configured for the device, and click [OK].

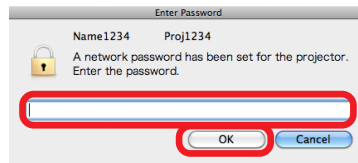

Memo

- When [Cancel] is clicked in the <Enter Password> screen, the screen preceding the device selection screen returns. For details on how to set the password, refer to the operating instructions for the device.
- If there is multiple devices that require password entry, the <Enter Password> screen is displayed for each device. Check the network ID, and enter the appropriate password.

When a device is equipped with Content Manager

When connecting to a device equipped with Content Manager, the <Content Manager> screen will appear.

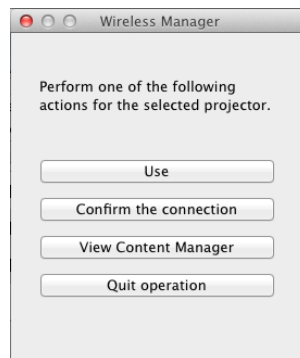

[Use]

Connect to the device and enable image display.

[Confirm the connection]

Make the indicator on the device to which you are attempting to connect blink.

[View Content Manager]

Display Content Manager using the computer's web browser.

[Quit operation]

Return to the device selection screen.

Memo

- You can check the status of signage playback and signage settings using Content Manager. For details on the signage playback and signage settings function, refer to the operating instructions for the device.

Operating the launcher

When you start the software, the launcher appears with the <Simple connection> screen.

A variety of operations, including device operations (starting and stopping image display), volume adjustment, and display of other screens, can be performed using the launcher.

The buttons used to control image display are enabled when communication with the device is enabled.

■ Launcher

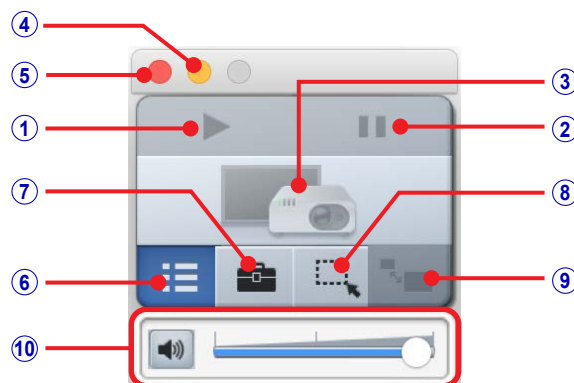

① Start or stop image display.

This changes to  (stop) during image display.

② Pause image display.

This can only be used during image display.
When used, the displayed image freezes.

③ Indicates the status of device communication via an icon.

When communicating with a single device, the icon for one device is displayed.



Image display not possible No communication due to lack of device selection.



Image display possible Devices are selected and communication is established.



Image display in progress Images are being displayed via devices and communication is established.

④ Minimize the launcher display.

⑤ Quit the software.

 Page 37

⑥ Displays the <Simple connection>, <Registered Projectors>, or <Find Projectors> screen.

This displays a device selection screen. The screen that was initially used to select the devices for image display will be displayed.

⑦ Display the <Option> screen.

 Page 47

⑧ Display the <Selective Area> screen.

 Page 45

⑨ Enlarge or shrink the displayed image.



This can only be used live mode images are being displayed via a compatible device.

 Page 48

⑩ Adjust the volume.

 Page 37

Memo

- The launcher may appear in the image display. Minimize the launcher to hide its display.
- The launcher position can be changed by dragging it with the mouse.
- When the launcher display has been minimized and placed in the Dock, the launcher can be displayed again by clicking  on the Dock.
- When [Start projection when a projector is selected] (page 47) is enabled, image display will start when connection with the device is established, and  does not need to be clicked.
- Video portions may not play back depending on the video playback application used.

Operating the launcher (cont.)

- When you use the launcher to start a device that is in standby mode, the device turns on and starts image display.

Attention

- When turning on a projector, be sure there is no one in the vicinity of the projector to avoid shining the projector's light into a person's eyes.

Memo

- Do not register power content to the timetable unless precautions have been taken during installation to ensure that the projector's light does not shine into the eyes of nearby people should projection start suddenly.

■ Adjusting the volume

- Adjust  in the launcher.

This adjusts the volume of the output audio.

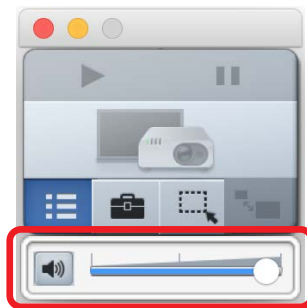

■ If the volume adjustment icon is not displayed

Click  in the launcher to open the <Option> screen, select [Settings], and select the [Produce audio along with video during projection] checkbox.

☞ “Setting the options” (page 47)

Memo

- This cannot be used if the software is not installed.
- This cannot be used when communicating with multiple devices simultaneously.
- As a specialized playback device is used for audio playback when the software is running, the computer's audio can only be output from the device during image display. When the software is exited, the original Windows playback device is restored.

■ Quitting the software

- Click  in the launcher.



Memo

- If the [A simple connection screen is displayed at startup] checkbox is not selected in the option settings and not a single device has been registered, the device that was used last will be automatically registered. If you were using multiple devices in such cases, the devices will be automatically registered as a group. The same device(s) can be selected again later from the <Registered Projectors> screen, allowing you to start image display quickly.

☞ “Selecting registered devices” (page 21)

Operating the menu bar

When  is clicked on the menu bar, the menu for operating the software and device is displayed. When the software is started up, the launcher is displayed, but the same operations can be performed from this menu as well.

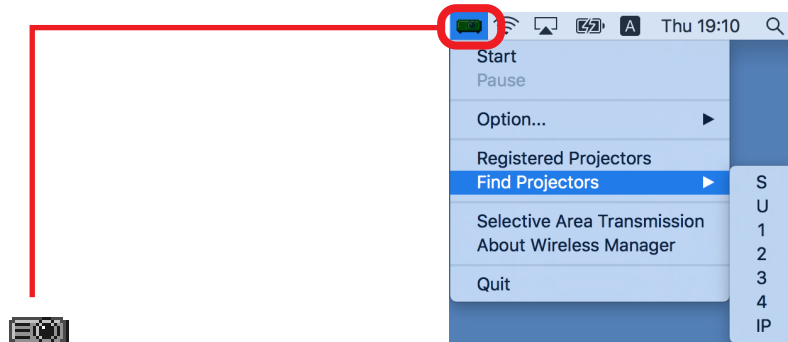

 Image display not possible (gray icon) Devices are not selected.



Image display possible (green icon) Devices are selected.

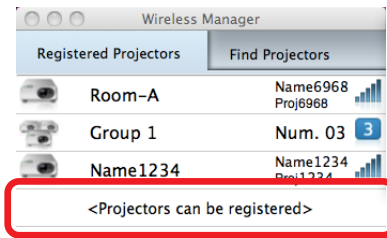

Image display in progress (blue icon) Images currently displayed via devices.

Start	Start image display. When image display is in progress, the item's display changes to [Stop projection]. When [Stop projection] is selected, the image display turns black.
Pause	Pause image display. When used, the displayed image freezes. When image display is paused, the item's display changes to [Resume projection].
Option	Display the <Option> screen. Page 47
Registered Projectors	Display the <Registered Projectors> screen. Page 18
Find Projectors	Select a network number from the pull-down menu to display the <Find Projectors> screen. The device with the selected network number is searched, and the result is displayed. Page 19
Selective Area Transmission	Display a specified area of the image. Page 45
About Wireless Manager	Display the version information of the software.
Quit	Quit the software.

Registering devices and groups

Up to four groups, each consisting of one or more devices, can be registered in the <Registered Projectors> screen. By registering a device, the computer's display screen can be displayed via the device with a single click.



When [<Projectors can be registered>] on the <Registered Projectors> screen is clicked, the <Register Projectors> screen is displayed.

■ <Register Projectors> screen

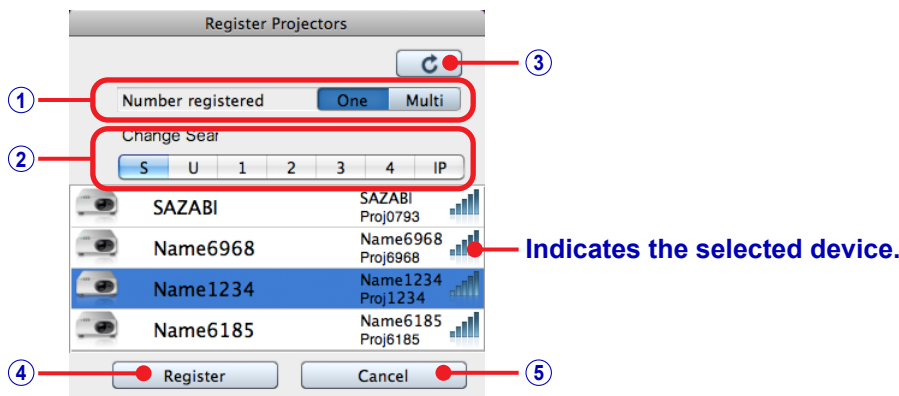

① [Number registered] buttons

Select whether to register one device or multiple devices as a group.

② [Change Search] buttons

Select the search method.

☞ "[Change Search] buttons" (page 19)

Button	Devices searched
<input type="button" value="S"/>	This searches for devices whose wireless LAN connection has been set to [SIMPLE], [S-DIRECT], or [S-MAP]. It is not possible to display the images via multiple devices simultaneously.
<input type="button" value="U"/>	This searches for devices whose wireless LAN connection has been set to [USER] or [M-DIRECT], or for devices connected via wired LAN.
<input type="button" value="1"/> to <input type="button" value="4"/>	These search for devices whose wireless LAN connection has been set to [1] to [4].
<input type="button" value="IP"/>	This searches for devices using a specified IP address.

③ Update button

Refresh the device search results.

④ [Register] button

Register the selected device, and return to the <Registered Projectors> screen.

☞ Page 18

⑤ [Cancel] button

Return to the <Registered Projectors> screen.

☞ Page 18

Registering devices and groups (cont.)

This section describes the procedure for registering devices and groups.

1 Start the software (), and display the <Registered Projectors> screen.

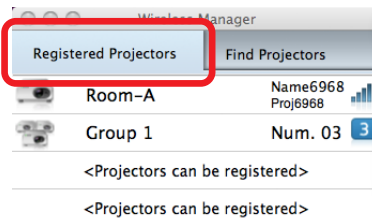

2 Click [<Projectors can be registered>] to display the <Register Projectors> screen.

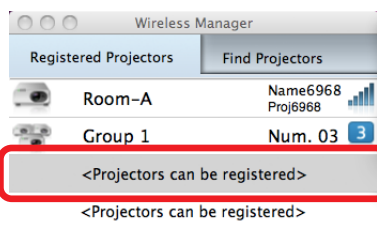

3 Click the **One** or **Multi** button for [Number registered] based on the number of devices to be registered, and click the [Change Search] button that corresponds to the wireless LAN connection method displayed on the device.

If the wireless LAN connection method is [SIMPLE], [S-DIRECT] or [S-MAP], click **S**.

For details on other wireless LAN connection methods, refer to “Devices searched” under “[Change Search] buttons” (page 19).

- When the <Register Projectors> screen is displayed, **One** is selected.
- When **Multi** is selected, **S** cannot be selected.



Network ID indicator
(projector image example)

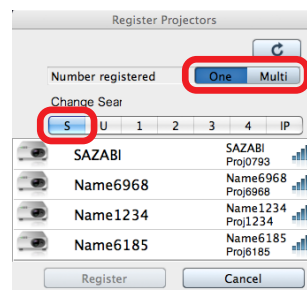

<Register Projectors> screen display example
(screenshot of the software)

4 Click the device that matches the projector name or display name and network ID displayed on the device.



Network ID indicator
(projector image example)

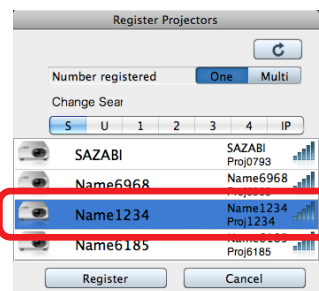

<Register Projectors> screen display example
(screenshot of the software)

Registering devices and groups (cont.)

5 Click [Register].

The registered device appears on the <Registered Projectors> screen.

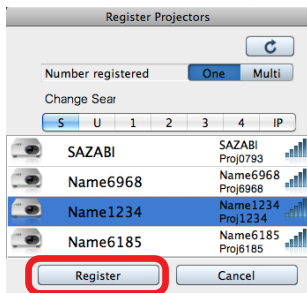

<Register Projectors> screen display example
(screenshot of the software)

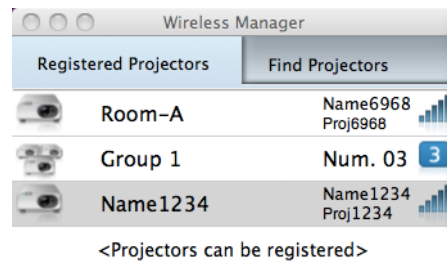

<Registered Projectors> screen display example
(screenshot of the software)

Memo

- The display locations of the projector name or display name and network ID may vary depending on the device.
["Checking the device"](#) (page 14)
- If the [SIMPLE] wireless LAN setting is configured, "SIMPLE" will be displayed as the registered name instead of the name that is configured on the device. For other wireless LAN settings, the projector name or display name will be used as the registered name.
To change the registered name, see "Changing registered names" (page 42).
- When registering multiple devices as a group, select the **Multi** button for [Number registered], and select and register all the devices to be used.
- When registering multiple devices as a group, the wireless LAN connection method of each device must be the same.

Changing registered names

The devices and groups registered in the <Registered Projectors> screen can be renamed.

- 1 On the <Registered Projectors> screen, click the secondary button on the name of the device or group to be changed.

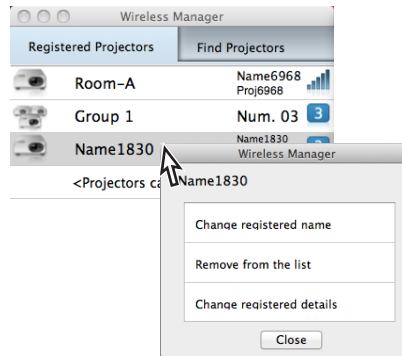

- 2 Click [Change registered name].

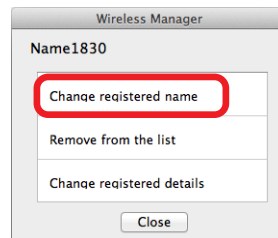

- 3 Enter the new name, and click [OK].

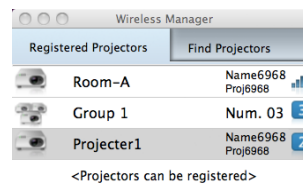
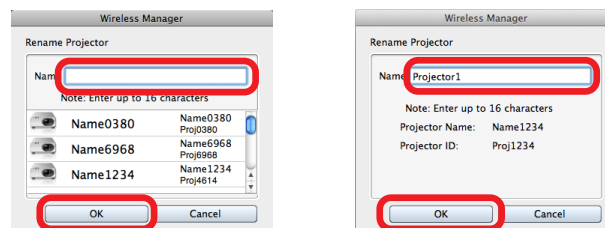

Memo

- Up to 16 characters can be entered.
- The following characters cannot be used.
¥ / : * ? " < > |

Removing registered devices and groups

The devices and groups registered in the <Registered Projectors> screen can be removed.

- 1 On the <Registered Projectors> screen, click the secondary button on the name of the device or group to be removed.

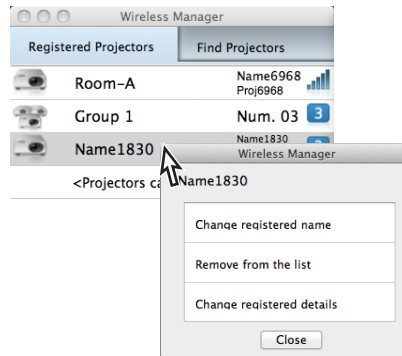

- 2 Click [Remove from the list].

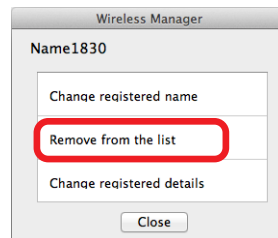

- 3 When the removal confirmation message appears, click [Yes].

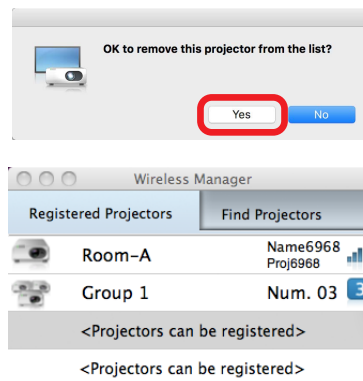

Changing registered devices and groups

The devices and groups registered in the <Registered Projectors> screen can be changed.

- 1 On the <Registered Projectors> screen, click the secondary button on the name of the device or group to be changed.

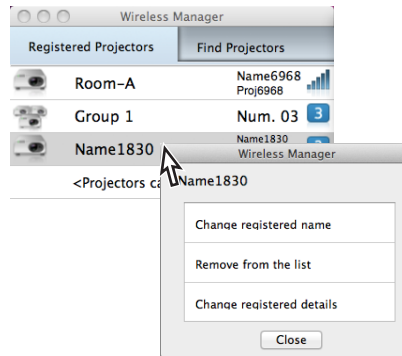

- 2 Click [Change registered details].

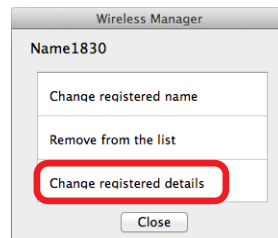

- 3 Search for the other device.

➔ “Registering devices and groups” (page 39)

- 4 When the change confirmation message appears, click [Yes].

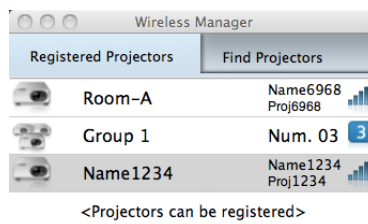
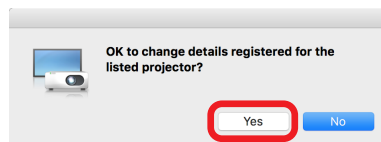

Specifying areas for transmission

Areas that display important information within the computer screen can be specified using the area specification window, and only those areas will appear in image displays.

1 Click in the launcher.

The area specification window appears.

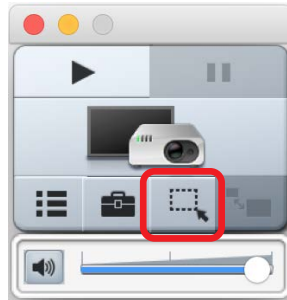

2 Specify the area to be transmitted using the area specification window.

The area specification window can be manipulated using standard window moving and resizing operations.



3 Click in the launcher.

The area within the area specification window is displayed.



■ Automatically adjusting the projection window size

Click  on the area specification window.

■ Restoring the default area specification window size

Click  on the area specification window.

Specifying areas for transmission (cont.)

■ Exiting area specification

- Click  at the top right of the area specification window.



Setting the options

Settings such as those used during image display can be changed using the option function.

Click  (Option) in the launcher to open the <Option> screen.

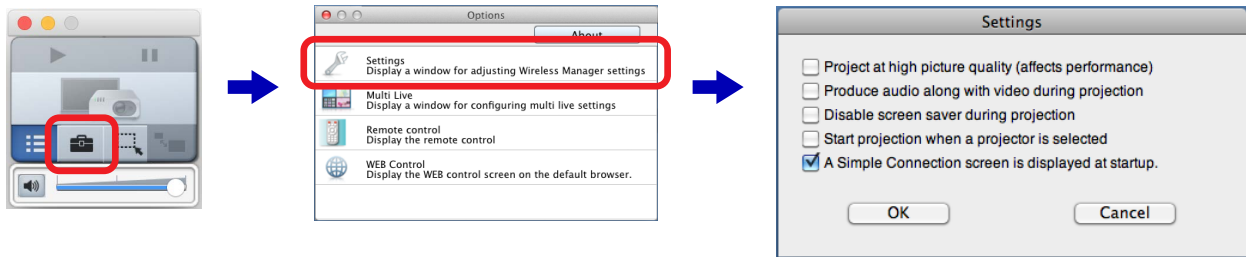

■ Settings

■ [Project at high picture quality (affects performance)]

Display images in high quality.

However, the priority on image quality may reduce the display speed.

To prioritize image display speed, clear the checkbox.

■ [Produce audio along with video during projection]

Output audio from the device during image display.

To disable audio output, clear the checkbox.

- This cannot be used when communicating with multiple devices simultaneously.

■ [Disable screen saver during projection]

Disable the computer's screen saver function during image display.

- As password protected screen savers will be disabled, be careful when stepping away from your computer.

■ [Start projection when a projector is selected]

Start image display automatically when a device is selected in the <Registered Projectors> screen or <Find Projectors> screen.

This eliminates the need to click  in the launcher.

Memo

- For a projector, the display resolution of projected images differs depending on the aspect ratio of the display device of the projector used.
 - When 4:3: Images of 1024 x 768 dots are displayed with the number of display dots of the projector.
 - When other than 4:3: Images of 1280 x 800 dots are displayed with the number of display dots of the projector.
- For a flat-panel display, images of 1280 x 800 dots are displayed with the number of display dots of the flat-panel display.

■ Other settings

■ [A simple connection screen is displayed at startup]

Display the <Simple connection> screen at software startup when this is selected, and the <Register Projectors> or <Find Projectors> screen when this is cleared.

- When this checkbox is cleared and no devices have been registered, the <Register Projectors> screen appears. Turn on the device to be used, and follow the instructions on the screen to register the device with the software.

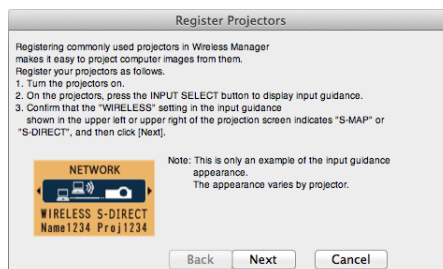

Memo

- To end operation without registering the devices, click [Cancel].

Live mode

Using live mode allows you to display the screen image from a single computer on other devices. On device models that support moderator mode, screen images from up to four computers can also be displayed in split display depending on the number of connected individuals. This mode is ideal for presentations in front of small groups during a meeting, for example.



■ Device models that support moderator mode

Screen images from up to four computers can be displayed in full-screen or split-screen display.

1 Change the setting on the device.

Set [MENU] → [NETWORK/USB] → [Panasonic APPLICATION] → [Moderator mode] to [OFF].

2 Click in the launcher.

A split-screen display based on the number of connected computers will appear.

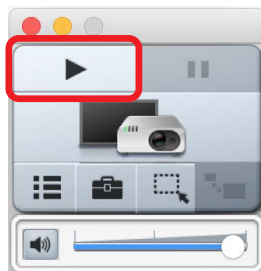

- **Switching to full-screen display**

Click  in the launcher of one of the computers during split-screen display to display that computer's screen in full screen.

- **Switching to split-screen display**

Click  in the launcher of the computer being displayed in full screen to return to split-screen display.

- **Switching from one computer's screen to another computer's screen**

Click  in the launcher of one of the computers while another computer's screen is being displayed in full screen to switch the full-screen display to the that of the new computer.

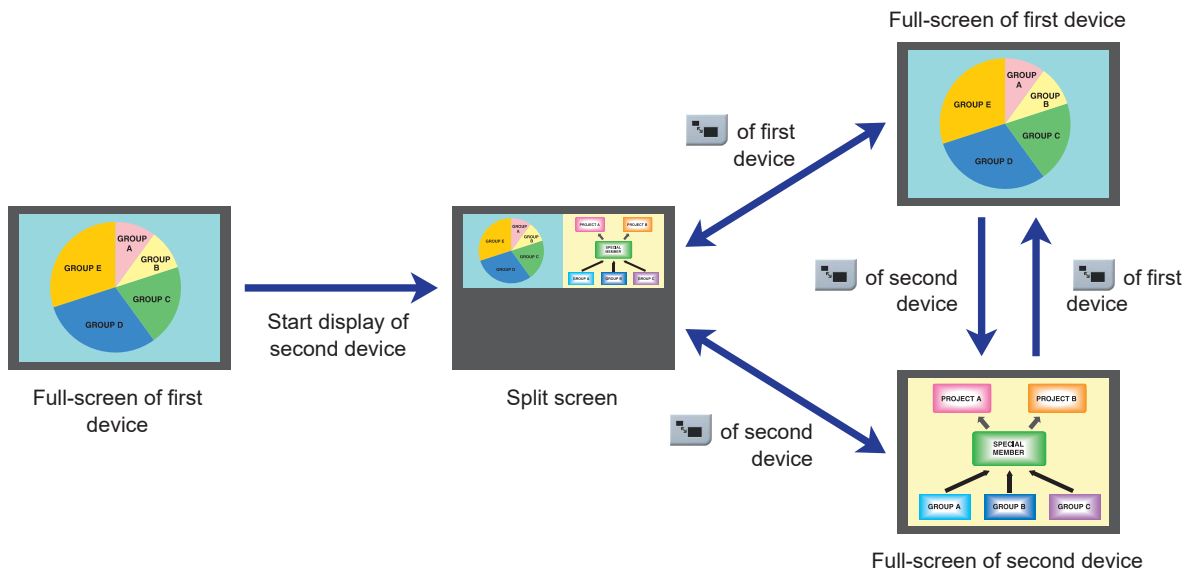

Live mode (cont.)

Memo

- When another computer's screen is being displayed in full screen, clicking  in the launcher may not switch the full-screen display. In such cases, configure the following settings for the device.
Set [MENU] → [NETWORK/USB] → [Panasonic APPLICATION] → [CUT IN] to [ON].

■ Device models that do not support moderator mode

Screen images from a single computer can be displayed in full screen.

The device operation will differ depending on its setting.

- **When [MENU] → [NETWORK/USB] → [LIVE MODE CUT IN] is set to [ON]**
When display is started on another computer, the full-screen display switches to the screen image of that computer.
- **When [MENU] → [NETWORK/USB] → [LIVE MODE CUT IN] is set to [OFF]**
When display is started from another computer, the full-screen display of the current computer's screen remains.

Multi live mode

When using the multi live mode, images can be displayed by multiple individuals from multiple computers via a single device.

This function comes in handy when holding meetings attended by participants using a multiple number of computers.

Memo

- This function is not available on device models that support moderator mode. To project multiple computer images with such models, use moderator mode.

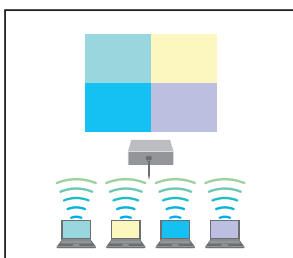
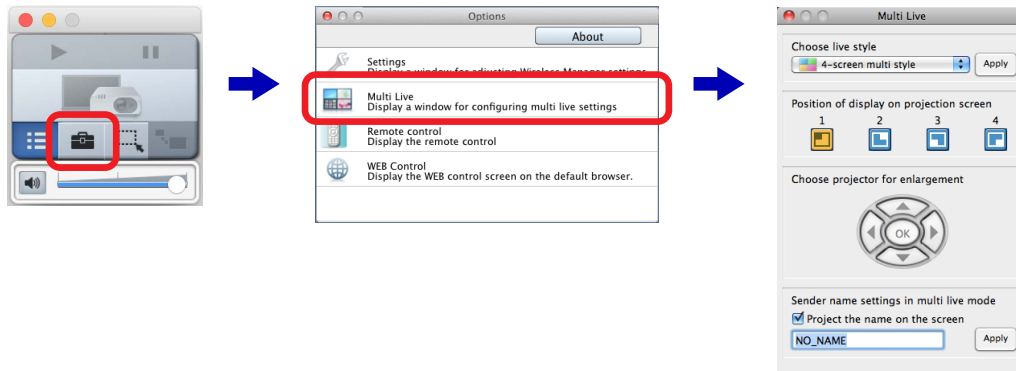

Conduct presentations using up to four computers

<4-screen multi style> [page 52](#)

Displays up to four computer screen images simultaneously.

As each computer screen can be viewed at the same time, this style is ideal for meetings in which all the individuals participate.

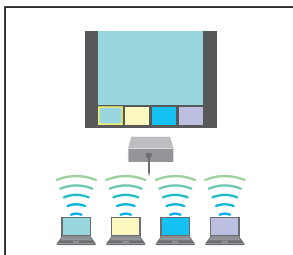

Presenters control the presentation using up to four computers

<4-screen index style> [page 53](#)

Displays thumbnails of the four computer screens, and allows the computer screen that has been selected using the remote control to be displayed in full screen.

The presenter has full control of the displayed images and can provide appropriate real-time commentary during the presentation.

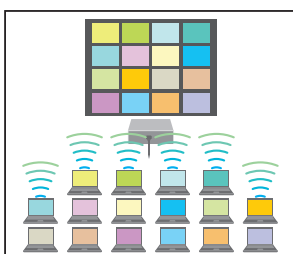

Large-scale presentation style for university seminars or academic conferences

<16-screen index style> [page 54](#)

Displays thumbnails of 16 computer screens.

This style is ideal for displaying a large number of computer screens in a matrix during university seminars, academic conferences, or group study sessions, for example.

■ Switching the live styles

● Switching styles using the device's menu

Select [MULTI-LIVE] in the device's [Network] menu, and press the <ENTER> button.

📖 Operating instructions for the projector or flat-panel display

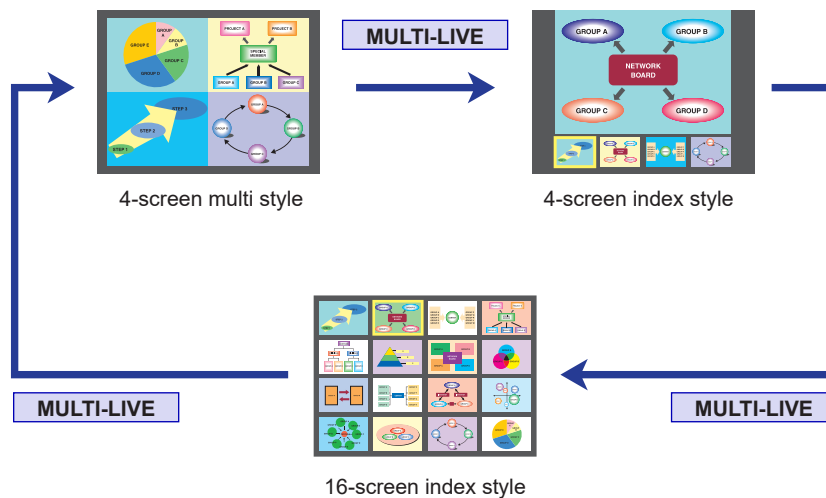

● Switching styles using the software

Select the style on the software's <Multi Live> screen.

📌 Memo 📌

- When the device starts up, it resumes in the style was being used the last time the device was turned off.
- When there is no communication with any device, all operations in the <Multi Live> screen are disabled, except for "Setting the sender's names" (page 55).
 - The device communication status is indicated by a launcher icon (page 36).
- <Multi Live> screen operations are disabled during communication with multiple devices.
- To exit the multi live mode, select [Full screen style] for [Choose live style], and click [Apply].
- If the style is switched from the 16-screen index style to the 4-screen multi style while communicating with five or more computers, communication with the fifth and subsequent computers will be severed.
- Live style selection is not possible during full-screen image display from the device.
 - Stop image display via the device before selecting the live style.
- This function can only be used on supported models. For details, refer to the "List of Compatible Device Models".

Multi live mode (cont.)

■ 4-screen multi style

Screen images from up to 4 computers are displayed at the same time from a single device.

1 Click  in the launcher, and click [Multi Live] on the <Option> screen.

 “Switching styles using the software” (page 51)

2 Select [4-screen multi style] for [Choose live style], and click [Apply].

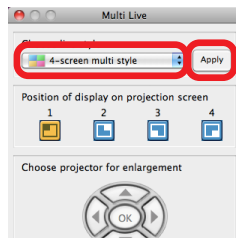

3 Click the icon for the desired image display position.

- Select where on the screen the images are to be displayed.

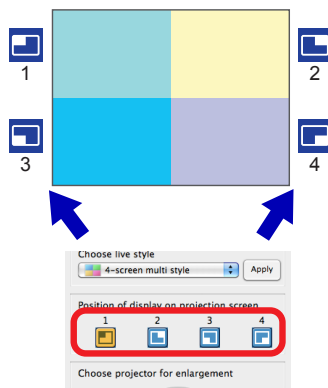

4 Click  in the launcher.

The images on the computer screen are displayed via the device.

- **Switching the image display position**
To change the image display position, click the desired icon under [Position of display on projection screen].
- **Exiting the 4-screen multi style**
To exit the 4-screen multi style, select [Full screen style] for [Choose live style], and click [Apply].

Memo

- If a position in which a computer's screen image is already displayed is selected for another computer's the image display, the image display will switch to that of the later computer.
- 4-screen multi style can only be selected when full-screen live is in progress or when the other terminals are using 4-screen multi style.

Multi live mode (cont.)

■ 4-screen index style

Screen images from up to four computers are displayed simultaneously from a single device via index screens and a large screen.

1 Click  in the launcher, and click [Multi Live] on the <Option> screen.
☞ “Switching styles using the software” (page 51)

2 Select [4-screen index style] for [Choose live style], and click [Apply].

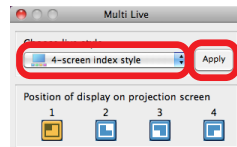

3 Click the number of the desired image display position.

- Select where on the index screen (sub screen) the image is to be displayed.

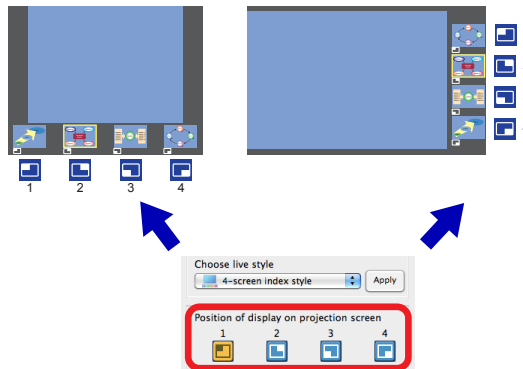



4 Click  in the launcher.

The images on the computer screen are displayed via the device.

● **Switching the image display position**

To change the image display position, click the desired icon under [Position of display on projection screen].

● **Switching to full-screen display**

To display an image in full screen, click  under [Choose projector for enlargement] to select the index screen to be enlarged (i.e., move the yellow frame), and click .

Click  again to display the image in full screen.

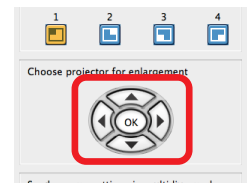

To return to the index screen, click  again.



● **Exiting the 4-screen index style**

To exit the 4-screen index style, select [Full screen style] for [Choose live style], and click [Apply].

Memo

- When other computers are displaying images in the 4-screen index style, images can only be displayed in unused index screens (sub screens).
- The menus on the device side and the remote control (page 58) can also be used to switch between full-screen display and index screen display.
- Some device models have   (page navigation) buttons on their remote controls, but these buttons cannot be used to select target index screens (i.e., move the yellow frame).
☞ Operating instructions for the projector or flat-panel display

Multi live mode (cont.)

■ 16-screen index style

Screen images from up to 16 computers are displayed at the same time from a single device.

1 Click  in the launcher, and click [Multi Live] on the <Option> screen.

 "Switching styles using the software" (page 51)

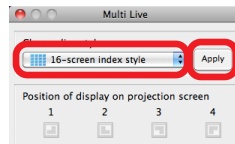

2 Select [16-screen index style] for [Choose live style], and click [Apply].



3 Click  in the launcher.

The images on the computer screen are automatically displayed in one of the vacant index screens (sub screens). The image display position cannot be selected.

● **Switching to full-screen display**

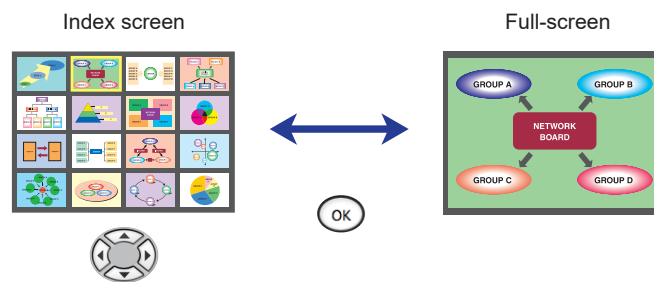

To display an image in full screen, click  under [Choose projector for enlargement] to select the index screen to be enlarged (i.e., move the yellow frame), and click . Click  again to return to the index screen.



● **Exiting the 16-screen index style**

To exit the 16-screen index style, select [Full screen style] for [Choose live style], and click [Apply].

 **Memo** 

- When other computers are displaying images in the 16-screen index style, images can only be displayed in unused index screens (sub screens).
- The menus on the device side and the remote control (page 58) can also be used to switch between full-screen display and index screen display.
- Some device models have  (page navigation) buttons on their remote controls, but these buttons cannot be used to select target index screens (i.e., move the yellow frame).
 [Operating instructions for the projector or flat-panel display](#)

Multi live mode (cont.)

■ Setting the sender's names

The names of the senders can be displayed on the images displayed in the multi live mode.

1 Select the [Project the name on the screen] checkbox on the <Multi Live> screen.

2 Enter the name of the sender, and click [Apply].

- Enter up to 8 alphanumeric characters.

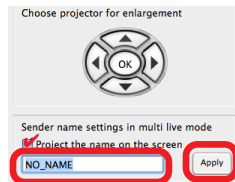

Memo

- When the 4-screen index style or 16-screen index style is used, the sender's name will be displayed, even if the [Project the name on the screen] check mark is removed.

Moderator mode

In this mode, a moderator can use the remote control or the WEB Control screen to select which terminal to display in full screen via the device.

The screen images from a single computer can be selected/deselected from among up to 16 computers for full-screen display via the device in this useful mode.

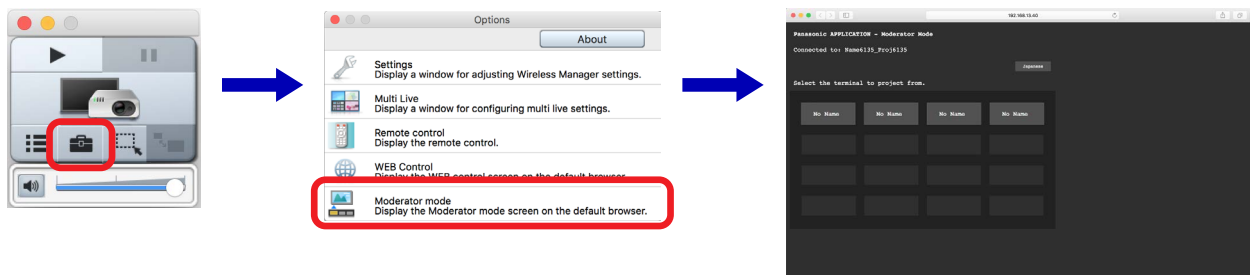

■ Selecting the computer screen to be displayed

- 1** Set [MENU] → [NETWORK/USB] → [Panasonic APPLICATION] → [Moderator mode] to [ON] on the device.
- 2** Click  in the launcher, and click [Moderator mode] on the <Option> screen.
The web browser opens, and an authentication dialog box appears.
- 3** Enter the moderator user name and password configured on the device, and click [OK].
The [Panasonic APPLICATION - Moderator Mode] page appears.
- 4** Click the sender name button of the computer to be displayed.
The selected computer screen is displayed via the device in full screen.
The color of the sender name button for the computer displayed in full screen changes at this time. If you click the sender name button for the computer displayed in full screen again, the screen displaying multiple computer screens returns.

Memo

- This function can only be used on supported models. For details, refer to the “List of Compatible Device Models”.
- [Moderator mode] will only appear in the <Option> screen during communication with devices that support moderator mode.
- The supported web browsers and information displayed in the web browser may differ depending on the model of the communicating device.
🔗 [Operating instructions for the projector or flat-panel display](#)
- When the wireless LAN is set to [SIMPLE] or [M-DIRECT], the maximum number of computers that can be connected via wireless LAN and the maximum number of images that can be displayed are ten.
- The default settings for the moderator user name and password entered in the web browser screen that appears when you click [Moderator mode] are as follows. However, the password differs depending on the model of the device being used, so refer to the operating instructions for the device.
User name: moderator
Password: @Panasonic (or “panasonic”)
- The moderator user name and password can be changed by using an account with administrator privileges to log on, and clicking the [PASSWORD CHANGE] in the WEB Control screen.
- The web browser screen that appears after clicking [Moderator mode] can be operated as a user with WEB Control administrator privileges, but we recommend operation by a designated moderator mode user.
- [Moderator mode] cannot be used when communicating with multiple devices.

Multi-device live mode

In this mode, the images from a single computer can be displayed on multiple devices (up to 8). To use multi-device live mode, the wireless LAN connection for the devices must be set to [USER].
 ☞ “Use with the [USER] setting” (page 25)

1 Connect the devices and computer to the same network.

For details on configuring network settings, see steps 1 to 3 in the “Use with the [USER] setting” (page 25) section.

2 Start the software (), and select the multiple devices.

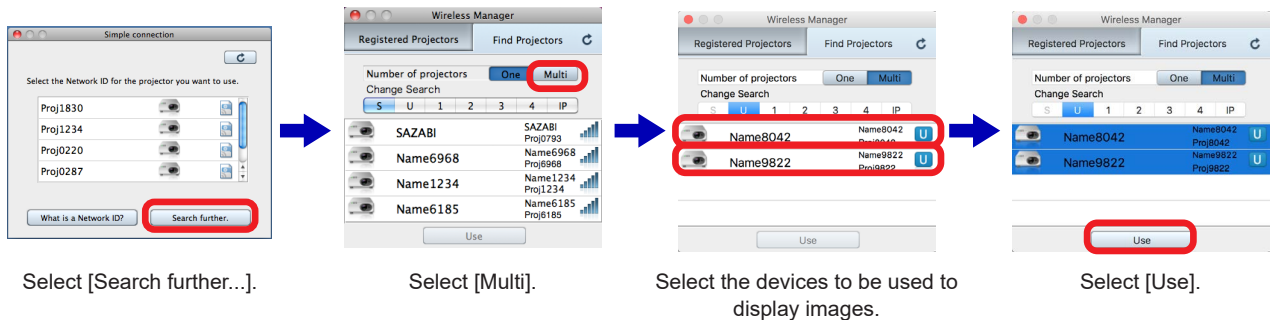

3 Click in the launcher.

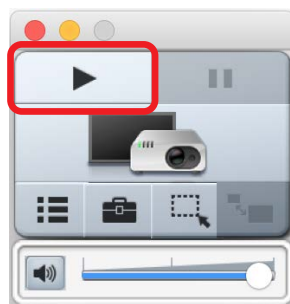

Memo

- Up to eight devices can be selected.
- To use multi-device live mode with devices that support moderator mode, [MENU] → [NETWORK/USB] → [Panasonic APPLICATION] → [Moderator mode] must be set to [OFF] on the device.
- To use multi-device live mode with devices that do not support moderator mode, the multi live mode must be set to 4-screen multi style.
 ☞ “Multi live mode” (page 50)

Browser Remote Control

Remote Control or Browser Remote Control can be displayed on the computer screen to control the devices.

Browser Remote Control makes it possible to control devices using a variety of buttons that appear on a web browser. The buttons displayed vary depending on the model of the connected device.

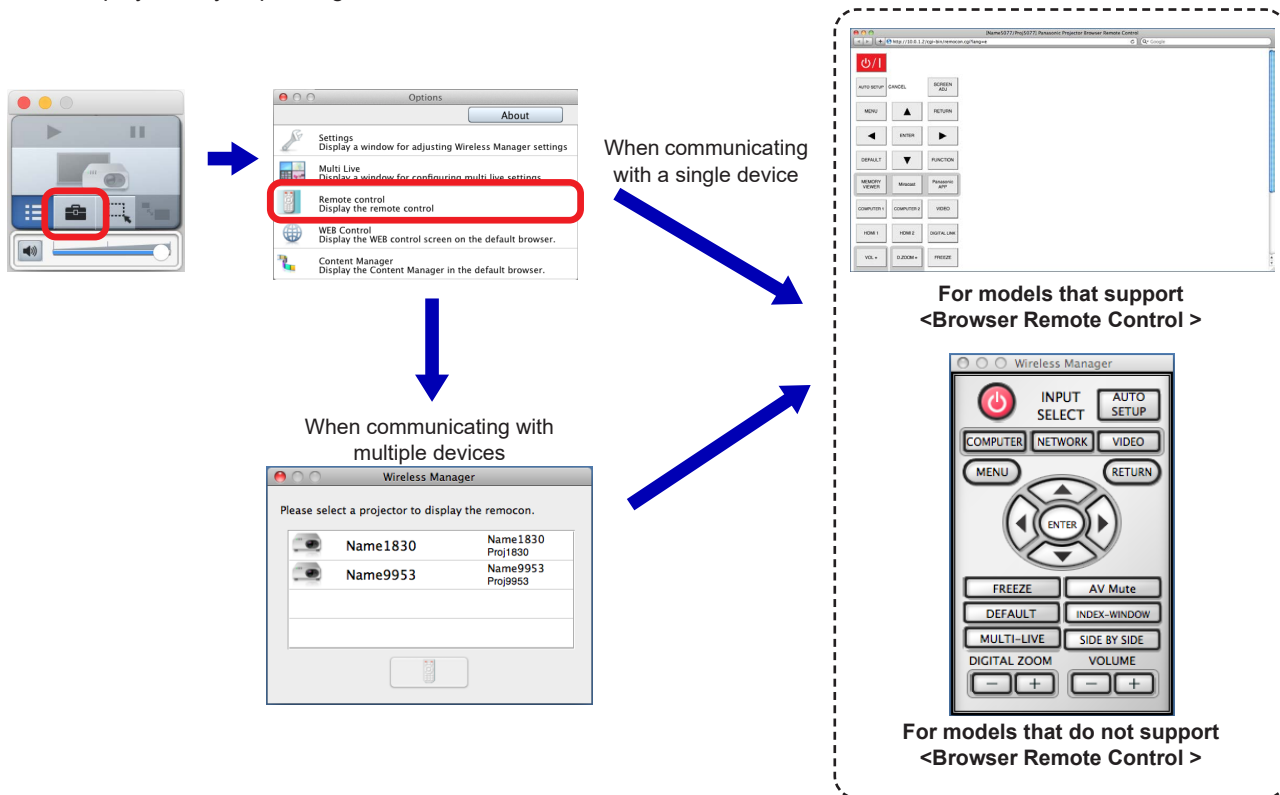

Memo

- Control is only possible during communication with the device.
The device communication status is indicated by a launcher icon (page 36).
 - To control multiple devices, select each device and control them individually.
 - Browser Remote Control can only be displayed for devices that support it. For details on supported models, refer to the "List of Compatible Device Models" on the website ((<https://panasonic.net/cns/projector/download/application/>) or (<https://panasonic.net/cns/prodisplays/download/software/>)).
 - When controlling devices that do not support Browser Remote Control, some buttons may not be usable.
 - Enter the user name and password configured for each communicating device in the authentication screen that appears when [Remote control] is clicked.
- 📖 Operating instructions for the projector or flat-panel display

WEB control

The computer's web browser can be used to control the device.

☞ [Operating instructions for the projector or flat-panel display or Network Operations](#)

- If communication with multiple devices is established, select the device to be operated, and click [WEB Control].

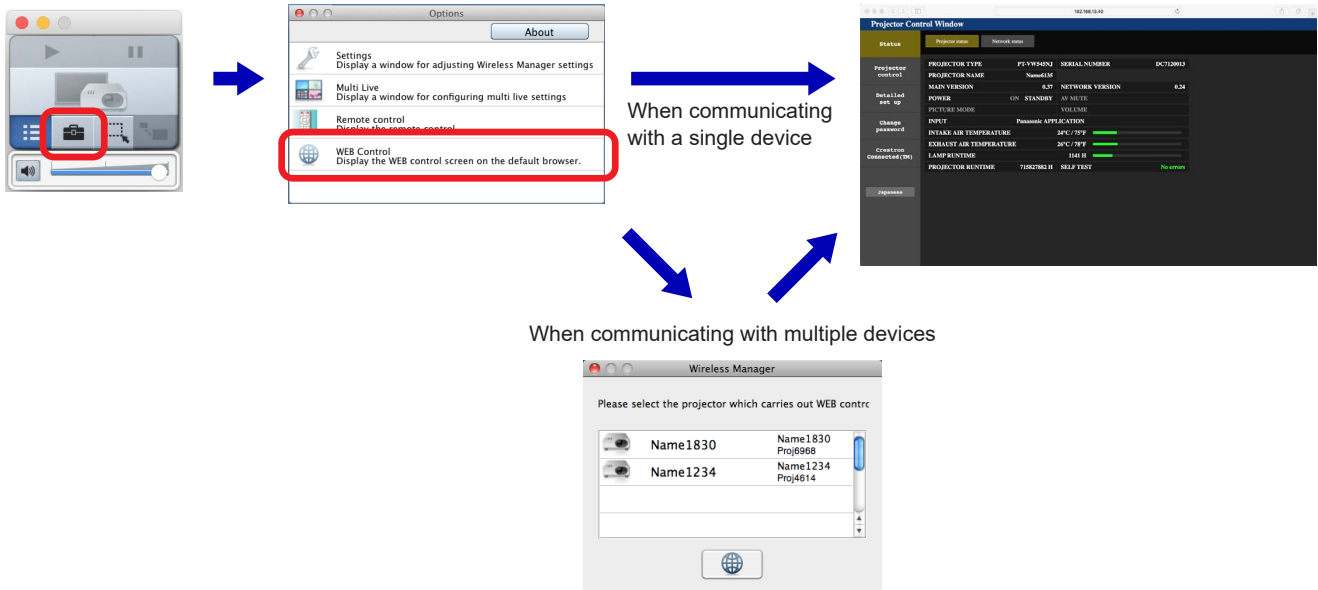

Memo

- Control is only possible during communication with the device.
The device communication status is indicated by a launcher icon ([page 36](#)).
- The information displayed in the web browser may differ depending on the model of the communicating device.
- Enter the user name and password configured for each communicating device in the authentication screen that appears when [WEB Control] is clicked.
☞ [Operating instructions for the projector or flat-panel display](#)

Content Manager

The computer's web browser can be used to display Content Manager.

[Operating instructions for the projector or flat-panel display](#)

- If communication with multiple devices is established, select the device for which to display Content Manager, and click [Content Manager].

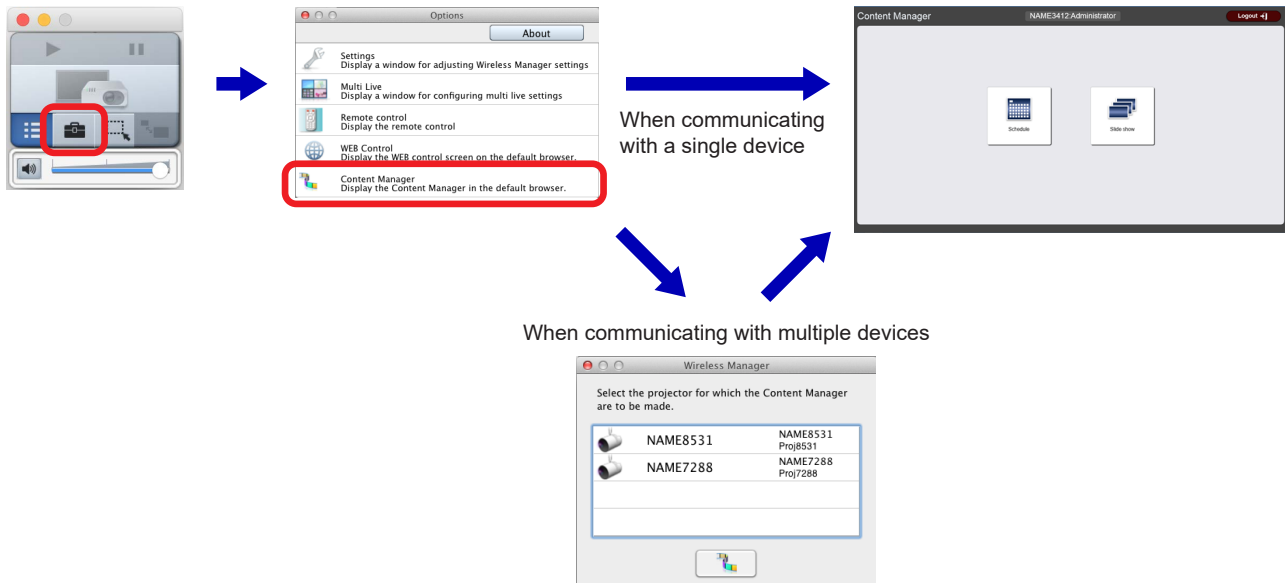

Memo

- [Content Manager] will only appear in the <Option> screen when communicating with a device equipped with Content Manager.
 - The supported web browsers and information displayed in the web browser may differ depending on the model of the communicating device.
- [Operating instructions for the projector or flat-panel display](#)

Version information

The version information of the software can be displayed.

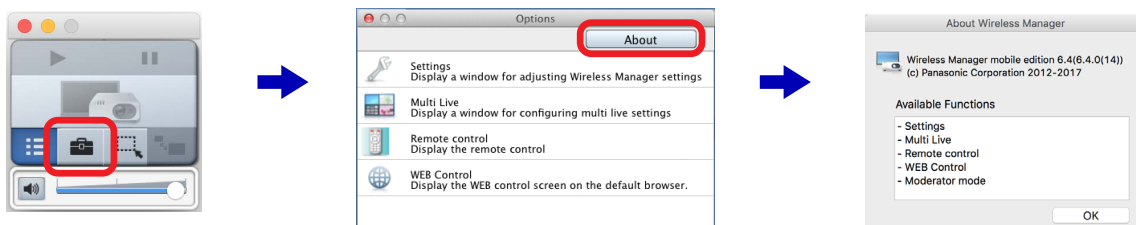

Glossary

Word	Explanation
Access point	This is a device which serves as a transmitter and receiver of radio signals when a computer and network are connected using a wireless LAN. When a computer is connected to an access point, it can communicate through the network connected to the access point.
Account User account	This refers to the registered name used to identify the individual (user) who uses the computer, and it may be “administrator” or “standard user”. It may not be possible for a standard user to use some functions or software applications.
Account with administrator privileges	This account enables changes affecting other users to be made.
AD HOC	This is the mode in which computers communicate with each other directly, rather than via access points.
AES	Abbreviation for “Advanced Encryption Standard”. The standard prevents the decryption of the encryption keys by continually changing the keys even during communication for greater security. Since the hardware performs the encryption processing, the access point must also support AES. Next generation standard cryptography standardized by the National Institute of Standards and Technology (NIST).
Default Gateway	Default Gateway enables a connection with other network, by adjusting bilateral differences such as communication protocols. If no gateway is specified for the IP address of access destination, data will be sent to the host set as the default gateway.
DHCP	Abbreviation for “Dynamic Host Configuration Protocol”. This function automatically assigns IP addresses to the connected equipment. If a device with the DHCP server function is present within a LAN, it automatically assigns IP addresses to the connected equipment.
Encryption	This refers to converting data into a form which is not understandable to other people. Decisions are made in advance on the rules (algorithms) and keys (network keys) for converting the data between the sender and receiver, and the data converted (encrypted) by the sender is restored to its original form (decrypted) by the receiver. Important exchanges can be made without their being read by other parties.
Firewall	This is a security system designed to protect computers from unauthorized access via a network (such as the internet). Unauthorized access is prevented by restricting the data exchanged between the network and computer, and allowing only authorized data to pass through to the computer.
Hub	This device brings together cables of the same type in order to relay information. USB hubs and network hubs are examples.
Infrastructure Mode	In this mode, communication passes through an access point.
IP address	Internet Protocol (IP) is a protocol for distributing data, and the address corresponding to the data distribution destination is called the IP address. The same IP address cannot be used within the same LAN.
LAN	Abbreviation for “Local Area Network”. This is a network with a relatively narrow range such as inside a company.
Login	This action establishes the status in which a network or computer system can be accessed. It is also called ‘logon’.
MAC address	This is the intrinsic ID number that is allocated to each network adapter. Every network adapter in the world is given its own number, and it is based on this number that data is sent and received between adapters. This address is expressed by combining an intrinsic number controlled and allocated by IEEE to each manufacturer with a number which the manufacturer allocates to each of its adapters.

Glossary (cont.)

Word	Explanation
MPEG	<p>This refers to a group of technology standards aimed at efficiently compressing digital moving images.</p> <p>One such standard is MPEG2 which has an excellent image quality and is used for DVD-Video and other video formats.</p> <p>Another standard is MPEG1 which has a lower compression rate than MPEG2, and is used by video CDs. Yet another standard is MPEG4 for distributing images with a low image quality and high compression rate over telephone lines and other lines with a low communication speed.</p>
Open System/OPEN	<p>This is an authentication of wireless signals employing a public key encryption system.</p>
Protocol	<p>This is a common convention or rule required for data communication between computers. In order to enable data exchanges between different computers, it is necessary to have at both ends the same convention or rule governing such aspects as the timing at which the data is sent and received, and the format used for information which is to be sent and received. For instance, many different kinds of software communicate data over the internet using a protocol called TCP/IP (Transmission Control Protocol/Internet Protocol).</p>
Router	<p>This device serves as a relay between different networks, and it establishes a connection between them.</p> <p>When data is transferred over a network, it must select the appropriate transfer path from among a multiple number of networks.</p>
SSID	<p>Abbreviation for "Service Set ID".</p> <p>The SSID identification code must be set to distinguish equipment included in a wireless LAN that uses access points from equipment not included in that LAN.</p> <p>This may appear as the "ESSID" or the "network name" for wireless LAN adapters made by some manufacturers.</p>
Subnetmask	<p>This limits the range of the IP addresses assigned to computers in order to divide the network into a number of sections during TCP/IP connection.</p> <p>The value used to divide the network at this time is called the subnet mask.</p>
WEP	<p>Abbreviation for "Wired Equivalent Privacy".</p> <p>This is a method for encrypting communication data. The encryption key is created and notified only to the communicating user, so the communication data cannot be decrypted by a third party.</p>
Wireless LAN	<p>This is a network which uses signals to communicate wirelessly.</p> <p>It obviates the need for a LAN cable connection since the data is sent and received using a common wireless frequency.</p> <p>SSID or WEP can be used to ensure that the transfer of information remains secure.</p>

Frequently Asked Questions

■ Wireless LAN connection cannot be established between the devices and the computer.

● Has the software been started up?

The software must be started on the computer to enable wireless transmission of images to devices.

● Have the correct network settings been configured?

When selecting a device whose wireless LAN connection method is [USER] or [M-DIRECT], check whether the correct network settings have been configured for the device and the computer.

● When the firewall is [ON]

Stop the firewall, and then start this software.

● Connection failure may occur in some cases immediately after turning on the device or immediately after switching the input.

Wait at least 1 minute before performing connection.

■ The user does not have administrator privileges.

If there are no administrator privileges, the administrator's name and password must be entered.

■ The wireless LAN or wired LAN connection is lost.

If image display is suspended or communication is cut off, select the device again in the device list.

If communication with the device is still not possible, turn off the device, and wait until it has cooled down (i.e., until the main unit's power monitor changes from orange to red) before turning off the main unit's main power switch (if it has one).

If it does not have a switch, disconnect the power cable.

Turn the power back on, and then select the device again from the software.

( Page 21)

■ Making a wireless LAN connection while using the Internet.

● In a wireless LAN environment in which Internet connection is possible, incorporating the device into this wireless LAN environment allows you to connect to the Internet and communicate with the device via wireless LAN at the same time.

( Page 25)

● If you have an Internet connection via wired LAN, simultaneous wireless use of the device is possible with the wired Internet connection.

■ IEEE802.11g / IEEE802.11n connection is not possible.

● In environments with wireless LAN adapters that support both IEEE802.11b and IEEE802.11g, the connection may be established via IEEE802.11b.

● In some operating environments, the connection may be established via IEEE802.11b, depending on the location, radio signal conditions, distance, or other factors.

● Some wireless LAN adapters only support AD HOC connections via IEEE802.11b.

● IEEE802.11n can be used only when the [SIMPLE], [S-DIRECT], [M-DIRECT], wireless module (Part No.: ET-WM200), and infrastructure connection (with access point for 802.11n) are used.

The [SIMPLE], [S-DIRECT], [M-DIRECT], and wireless module can be used only on certain device models.

For details, refer to the "List of Compatible Device Models" on the website

((<https://panasonic.net/cns/projector/download/application/>) or (<https://panasonic.net/cns/prodisplays/download/software/>)).

Alternatively, if you have the CD-ROM for this software that was supplied with your device, refer to the "List of Compatible Device Models" in the CD-ROM's application launcher.

■ The transfer rate is slow.

● The transfer rate may be slower in some operating environments (depending on such factors as the location, radio signal conditions or distance).

● Avoid placing metal objects or other conductors near the wireless LAN antenna of a computer, otherwise the transfer rate may be slower.

■ Image display fails to start.

On a computer that has an automatic graphics switching function, image display may fail if [System Configuration] → [Energy Saving] → [Automatic Graphics Switching] is enabled.

If image display start fails, disable this function.

Frequently Asked Questions (cont.)

■ Image display is slow or animation is not displayed smoothly.

- Is the computer CPU speed slow?
([Page 10](#))
Displaying images and playing animations depend largely on the performance of the computer's CPU.
- Adverse effects may occur if there is any wireless communication in the vicinity.
- If  (Option) in the launcher → [Settings] → [Project at high picture quality (affects performance)] is selected, the screen display speed may become slower.
([Page 47](#))
- The speed may be slower when any other applications are running concurrently.

■ DVD, MPEG2, or Blu-ray Disc content cannot be played on the computer.

- The following restrictions apply when the software is running.
 - DVD, MPEG2, and Blu-ray disc videos cannot be played back.
 - If a 3D-type application was used, application performance may be reduced, images may not be displayed, and proper operation may not be possible.
- Quit the software, and try using a computer cable or HDMI cable connection.
(Depending on the video player used, video playback may not be possible.)

■ There is a time lag between operations on the computer and their resulting image display.

- The software imports the computer screen, compresses the data, and transmits it to devices. In addition, the received data is extracted on the device before it is displayed.
Due to this processing time and factors in the wireless LAN environment, some delays will occur. Different computers may also produce varying lag times.

■ The live style cannot be changed.

- The live style cannot be changed on models that support moderator mode.
- Select  (Option) in the launcher → [Multi Live], select the live style in [Choose live style], and click [Apply] to switch the style.
([Page 51](#))
- When you click [Multi Live] on the remote control, the style is switched.
([Page 58](#))
- Switching is also possible by selecting [MULTI-LIVE] from the [Network] menu of the device, and then pressing the <ENTER> button.
- The live style cannot be changed during full-screen image display. Stop the image display before changing the live style.

■ The computer's audio is not heard from the device during image display.

- After installing this software, always reboot the system.
- This cannot be used when communicating with multiple devices simultaneously.
- Sound is not output if the driver has been uninstalled.
- If sound is not output from the internal speakers, quit this software, and then make sure that [Internal Speakers] is selected in [System Preferences] → [Sound] → [Output].
If it is not selected, manually switch to [Internal Speakers].

Frequently Asked Questions (cont.)

■ The software's colors are not displayed properly and the characters are hard to read.

- Check the [Colors] setting on the [Display] tab in [System Preferences].
Set [Colors] to [approx. 32000 Colors] or higher.
Images cannot be displayed with the [256 colors] setting.

■ The display brightness cannot be lowered.

- Is a checkmark placed next to [Disable screen saver during projection]?
Select  (Option) in the launcher → [Settings], and if a check mark has been placed next to [Disable screen saver during projection], the brightness of the built-in display cannot be lowered. (🔍 page 47)

■ When attempting to display images from a searched device, the device does not turn on.

- If the [STANDBY MODE] setting is set to [ECO] or [NETWORK] on a PT-VW345N, PT-VX415N, or other device model, that device may not turn on during for image display.
In such cases, set [STANDBY MODE] to [NORMAL].

■ The wireless LAN connection method, projector name or display name, and network ID are not displayed.

■ A device cannot be found.

- When the device is PT-VZ575N / PT-VW535N / PT-VX605N / PT-VZ585N, PT-VW345N / PT-VX415N, or PT-VW355N / PT-VX425N, the wireless LAN connection method, projector name or display name, and network ID may not appear or may not be found, depending on the device settings. Perform the following in such cases.
If [MENU] → [NETWORK] → [CONNECTION LOCK] is set to [OFF], press the <Panasonic APP> or <NETWORK/USB> button on the remote control (or the input selection button on the device) to change the input to [Panasonic APPLICATION].
If [MENU] → [NETWORK] → [CONNECTION LOCK] is set to [MEMORY VIEWER], [Miracast(TM)], or [MIRRORING], set [CONNECTION LOCK] to [Panasonic APPLICATION].

Frequently Asked Questions (cont.)

■ Image display stops.

When the Wireless Manager window of this software becomes inactive (i.e., the window is hidden behind another window or is minimized), image display may stop midway through due to the “App Nap” function of the OS. In such cases, perform the following to disable the App Nap setting of this software, and disable the App Nap function on the OS.

To disable the App Nap setting:

1. Quit the Wireless Manager software.
2. Display the information about this software.
Select [Finder] → [Applications] → [Wireless Manager], and select [Get Info] from the right-click menu.
3. Disable the App Nap setting.
Place a check mark next to [Prevent App Nap] in the information screen.
4. Close the information screen.
5. Start [Wireless Manager].
Click Wireless Manager in its installation location or in the Dock.

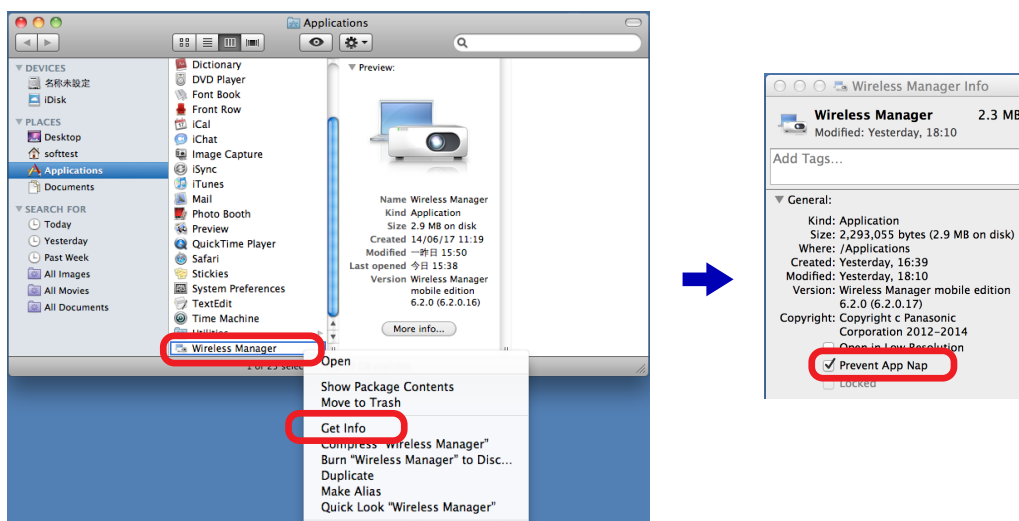

■ Image display stops midway through when playing back video at full screen.

If you start displaying images while playing back a video at full screen, the images may stop midway through. In such cases, change the display size of the playback video.

Example: Changing the setting in QuickTime Player

If you are using QuickTime Player as your media player, select [View] → [Fit to Screen] in the menu bar.

Trademarks

- Mac, macOS, OS X, QuickTime and App Nap are trademarks of Apple Inc., registered in the U.S. and other countries.
- Intel, Intel Core2 Duo and Intel Core i5 are trademarks or registered trademarks of Intel Corporation or its subsidiaries in the United States and/or other countries.
- Miracast™ is trademark of the Wi-Fi Alliance.
- Other company names, product names or other names noted in this manual are trademarks or registered trademarks of the respective companies. Note that ® and TM marks are not indicated in the text of this manual.

Notes:

- Unauthorized use or reproduction of part or all of this software and manuals is strictly prohibited.
- Panasonic Connect Co., Ltd. cannot be held liable for any effects resulting from the use of this software and manuals.
- Panasonic Connect Co., Ltd. reserves the right to revise the software specifications and manual contents without notice.

Panasonic Connect Co., Ltd.

Web Site : <https://panasonic.net/cns/projector/>
<https://panasonic.net/cns/prodisplays/>

© Panasonic Connect Co., Ltd. 2022

M0515AM8042 -PS