

# Panasonic®

Model No.

**TH-32LRU30**

**TH-37LRU30**

**TH-42LRU30**

## Owner's Manual

### Hospitality LCD HDTV

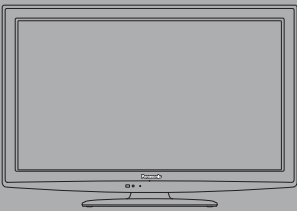

**English**

Thank you for purchasing this Panasonic product. Please read these instructions before operating your set and retain them for future reference. The images shown in this manual are for illustrative purposes only.



TQB2AA0623

# Experience an amazing level of multimedia excitement

## Enjoy rich multimedia

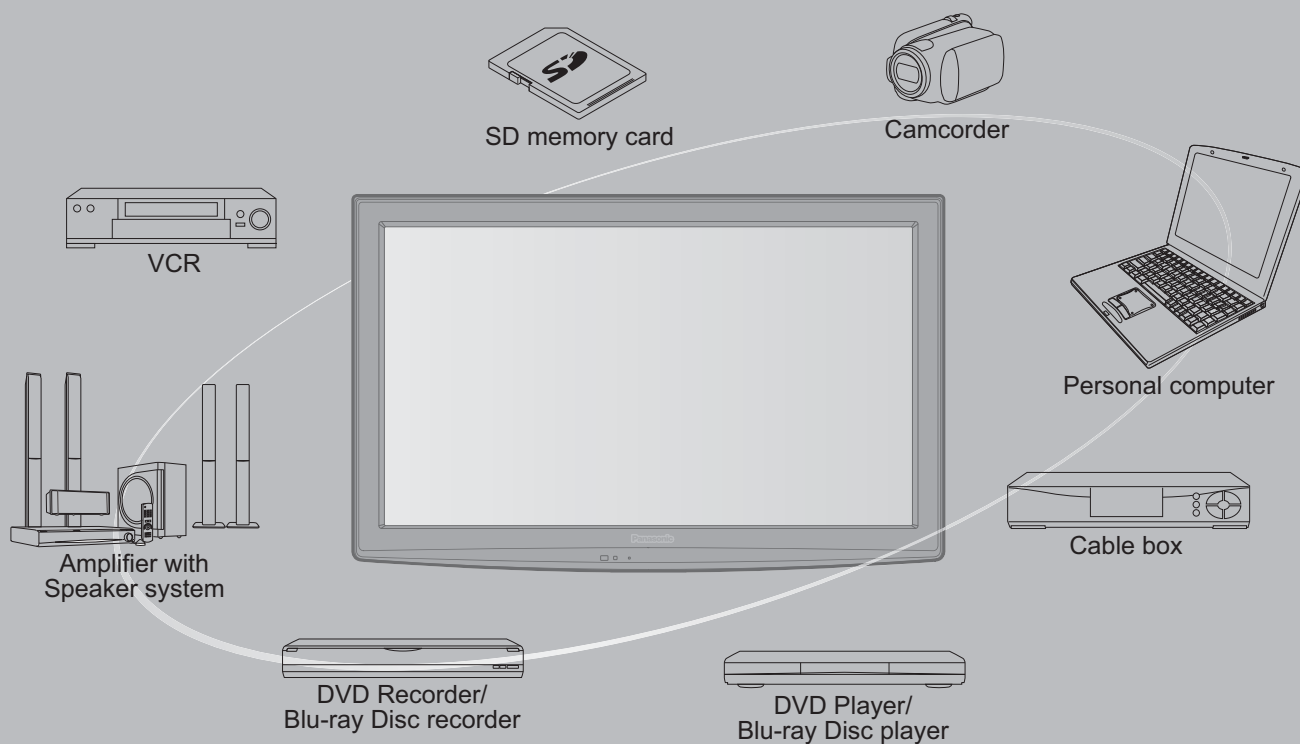

**This product incorporates the following software or technology:**

- (1) the software developed independently by or for Panasonic Corporation,
- (2) the software owned by third party and licensed to Panasonic Corporation,
- (3) the software developed by the Independent JPEG Group,
- (4) the software developed by the FreeType Project.



HDMI, the HDMI logo and High-Definition Multimedia Interface are trademarks or registered trademarks of HDMI Licensing LLC in the United States and other countries.



SDXC Logo is a trademark of SD-3C, LLC.



This product qualifies for ENERGY STAR in the factory default setting and this is the setting in which energy savings will be achieved. Any modifications to the factory default setting or other factory default settings could result in greater energy consumption beyond levels that meet ENERGY STAR qualifications.

Manufactured under license from Dolby Laboratories. Dolby and the double-D symbol are trademarks of Dolby Laboratories.



# Contents

## Please read before using the unit

- Safety Precautions ..... 4

## Quick Start Guide

- Accessories/Optional Accessory ..... 7
- Connections ..... 10
- Identifying Controls ..... 13

Quick Start Guide

## Enjoy your TV!

### Basic Features

- TV operation ..... 14
- Watching Videos and DVDs ..... 15
- Displaying PC screen on TV ..... 16
- Viewing from an SD card ..... 18

Viewing

## Advanced Features

- How to Use Menu Functions ..... 19
- Lock ..... 22
- Editing and Setting Channels ..... 24
- Closed Caption ..... 26
- Input Labels ..... 27
- Guest Menu ..... 28

Advanced

## FAQs, etc.

- Ratings List for Lock ..... 29
- Technical Information ..... 30
- FAQ ..... 34
- Care and Cleaning ..... 36
- Specifications ..... 37
- Limited Warranty ..... 38

FAQs, etc.



# Safety Precautions

	<b>CAUTION</b> <b>RISK OF ELECTRIC SHOCK</b> <b>DO NOT OPEN</b>	
<b>WARNING: To reduce the risk of electric shock, do not remove cover or back. No user-serviceable parts inside. Refer servicing to qualified service personnel.</b>		



The lightning flash with arrowhead within a triangle is intended to tell the user that parts inside the product are a risk of electric shock to persons.

The exclamation point within a triangle is intended to tell the user that important operating and servicing instructions are in the papers with the appliance.

## Note to CATV System Installer

This reminder is provided to direct the CATV system installer's attention to Article 820-40 of the NEC that provides guidelines for proper grounding and, in particular, specifies that the cable ground shall be connected to the grounding system of the building, as close to the point of cable entry as practical.

## Secure Ventilation

Slots and openings in the cabinet and the back or bottom are provided for ventilation, and to ensure reliable operation of the LCD TV and to protect it from overheating. These openings must not be blocked or covered. There should be at least 10 cm of space from these openings. The openings should never be blocked by placing the LCD TV on a bed, sofa, rug or other similar surface. This LCD TV should not be placed in a built-in installation such as a bookcase unless proper ventilation is provided.

## Important Safety Instructions

- 1) Read these instructions.
- 2) Keep these instructions.
- 3) Heed all warnings.
- 4) Follow all instructions.
- 5) Do not use this apparatus near water.
- 6) Clean only with dry cloth.
- 7) Do not block any ventilation openings. Install in accordance with the manufacturer's instructions.
- 8) Do not install near any heat sources such as radiators, heat registers, stoves or other apparatus (including amplifiers) that produce heat.
- 9) Do not defeat the safety purpose of the polarized or grounding-type plug. A polarized plug has two blades with one wider than the other. A grounding type plug has two blades and a third grounding prong. The wide blade or the third prong are provided for your safety. If the provided plug does not fit into your outlet, consult an electrician for replacement of the obsolete outlet.
- 10) Protect the power cord from being walked on or pinched particularly at plugs, convenience receptacles, and the point where they exit from the apparatus.
- 11) Only use attachments / accessories specified by the manufacturer.
- 12) Use only with the cart, stand, tripod, bracket or table specified by the manufacturer, or sold with the apparatus. When a cart is used, use caution when moving the cart / apparatus combination to avoid injury from tip-over.
- 13) Unplug this apparatus during lightning storms or when unused for long periods of time.
- 14) Refer all servicing to qualified service personnel. Servicing is required when the apparatus has been damaged in any way, such as power-supply cord or plug is damaged, liquid has been spilled or objects have fallen into the apparatus, the apparatus has been exposed to rain or moisture, does not operate normally, or has been dropped.
- 15) Operate only from the type of power source indicated on the marking label. If you are not sure of the type of power supplied to your home consult your television dealer or local power company.
- 16) Follow all warnings and instructions marked on the LCD TV.
- 17) Never push objects of any kind into this LCD TV through cabinet slots as they may touch dangerous voltage points or short out parts that could result in a fire or electric shock. Never spill liquid of any kind on the LCD TV.
- 18) If an outside antenna is connected to the television equipment, be sure the antenna system is grounded so as to provide some protection against voltage surges and built up static charges. In the U.S. Section 810-21 of the National Electrical Code provides information with respect to proper grounding of the mast and supporting structure, grounding of the lead-in wire to an antenna discharge unit, size of grounding conductors, location of antenna discharge unit, connection to grounding electrodes, and requirements for the grounding electrode.

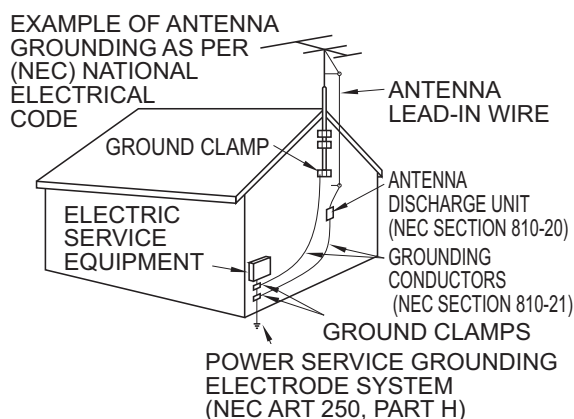

- 19) An outside antenna system should not be located in the vicinity of overhead power lines, other electric light, power circuits, or where it can fall into such power lines or circuits. When installing an outside antenna system, extreme care should be taken to keep from touching such power lines or circuits as contact with them might be fatal.
- 20) Unplug this LCD TV from the wall outlet and refer servicing to qualified service personnel under the following conditions:
- When the power cord or plug is damaged or frayed.
  - If liquid has been spilled into the LCD TV.
  - If the LCD TV has been exposed to rain or water.
  - If the LCD TV does not operate normally by following the operating instructions.  
Adjust only those controls that are covered by the operating instructions as improper adjustment of other controls may result in damage and will often require extensive work by a qualified technician to restore the LCD TV to normal operation.
  - If the LCD TV has been dropped or the cabinet has been damaged.
  - When the LCD TV exhibits a distinct change in performance - this indicates a need for service.
- 21) When replacement parts are required, be sure the service technician uses replacement parts specified by the manufacturer that have the same characteristics as the original parts. Unauthorized substitutions may result in fire, electric shock, or other hazards.
- 22) **WARNING: TO REDUCE THE RISK OF FIRE OR ELECTRIC SHOCK, DO NOT EXPOSE THIS APPARATUS TO RAIN, MOISTURE, DRIPPING OR SPLASHING. DO NOT PLACE LIQUID CONTAINERS (FLOWER VASES, CUPS, COSMETICS, ETC.) ABOVE THE SET (INCLUDING ON SHELVES ABOVE, ETC.).**
- 23) **WARNING: SMALL PARTS CAN PRESENT CHOKING HAZARD IF ACCIDENTALLY SWALLOWED. KEEP SMALL PARTS AWAY FROM YOUNG CHILDREN. DISCARD UNNEEDED SMALL PARTS AND OTHER OBJECTS, INCLUDING PACKAGING MATERIALS AND PLASTIC BAGS/SHEETS TO PREVENT THEM FROM BEING PLAYED WITH BY YOUNG CHILDREN, CREATING THE POTENTIAL RISK OF SUFFOCATION.**
- 24) **WARNING: To prevent the spread of fire, keep candles or other open flames away from this product at all times** 
- 25) **CAUTION:** The Power switch on this unit will not completely shut off all power from AC outlet. Since the power cord serves as the main disconnect device for the unit, you will need to unplug it from the AC outlet to shut down all power.  
Therefore, make sure the unit has been installed so that the power cord can be easily unplugged from AC outlet in case of an accident. To avoid fire hazard, the power cord should also be unplugged from the AC outlet when left unused for a long period of time (for example, when on vacation).
- 26) **CAUTION:** TO PREVENT ELECTRIC SHOCK, DO NOT USE THIS PLUG WITH A RECEPTACLE OR OTHER OUTLET UNLESS THE BLADES CAN BE FULLY INSERTED TO PREVENT BLADE EXPOSURE.
- 27) **CAUTION:** USE WITH OTHER STAND MAY RESULT IN INSTABILITY POSSIBLY CAUSING INJURY.
- 28) **CAUTION:** DANGER OF EXPLOSION IF BATTERY IS INCORRECTLY REPLACED. REPLACE ONLY WITH THE SAME OR EQUIVALENT TYPE.
- 29) **CAUTION: This LCD TV is for use only with the following optional accessory. Use with any other type of optional accessories may cause instability which could result in the possibility of injury.**  
(All of the following accessories are manufactured by Panasonic Corporation)  
• Wall-hanging bracket: TY-WK3L2RW  
Always be sure to ask a qualified technician to carry out set-up.

**NOTE:** This equipment is designed to operate in North America and other countries where the broadcasting system and AC house current are exactly the same as in North America.

## FCC STATEMENT

This equipment has been tested and found to comply with the limits for a Class B digital device, pursuant to Part 15 of the FCC Rules. These limits are designed to provide reasonable protection against harmful interference in a residential installation. This equipment generates, uses and can radiate radio frequency energy and, if not installed and used in accordance with the instructions, may cause harmful interference to radio communications. However, there is no guarantee that interference will not occur in a particular installation. If this equipment does cause harmful interference to radio or television reception, which can be determined by turning the equipment off and on, the user is encouraged to try to correct the interference by one or more of the following measures:

- Reorient or relocate the receiving antenna.
- Increase the separation between the equipment and receiver.
- Connect the equipment into an outlet on a circuit different from that to which the receiver is connected.
- Consult the dealer or an experienced radio/TV technician for help.

This device complies with Part 15 of the FCC Rules. Operation is subject to the following two conditions: (1) This device may not cause harmful interference, and (2) this device must accept any interference received, including interference that may cause undesired operation.

### FCC Caution:

**To assure continued compliance, follow the attached installation instructions and use only shielded interface cables when connecting to computer or peripheral devices. Any changes or modifications not expressly approved by Panasonic Corp. of North America could void the user's authority to operate this device.**

### FCC Declaration of Conformity Model No. TH-32LRU30, TH-37LRU30, TH-42LRU30

Responsible Party: Panasonic Corporation of North America  
Three Panasonic Way, 2F-5, Secaucus, NJ 07094  
Contact Source: Panasonic Solutions Company

# Safety Precautions (Continued)



## **▲WARNING**

CEA CHILD SAFETY NOTICES: Flat panel displays are not always supported on the proper stands or installed according to the manufacturer's recommendations. Flat panel displays that are inappropriately situated on dressers, bookcases, shelves, desks, speakers, chests or carts may fall over and may cause personal injury or even death.

The consumer electronics industry (of which Panasonic is a member) is committed to making home entertainment enjoyable and safe. To prevent personal injury or death, be sure to follow the following safety guidelines:

### **TUNE INTO SAFETY:**

- One size does NOT fit all. Follow the manufacturer's recommendations for the safe installation and use of your flat panel display.
- Carefully read and understand all enclosed instructions for proper use of this product.
- Don't allow children to climb on or play with furniture and television sets.
- Don't place flat panel displays on furniture that can easily be used as steps, such as a chest of drawers.
- Remember that children can become excited while watching a program, especially on "larger than life" flat panel displays. Care should be taken to install the display where it cannot be pushed, pulled over, or knocked down.
- Care should be taken to route all cords and cables connected to the flat panel display so that they cannot be pulled or grabbed by curious children.

### **WALL MOUNTING: IF YOU DECIDE TO WALL MOUNT YOUR FLAT PANEL DISPLAY, ALWAYS:**

- Use a mount that has been recommended by the display manufacturer and/or listed by an independent laboratory (such as UL, CSA, ETL).
- Follow all instructions supplied by the display and wall mount manufacturers.
- If you have any doubts about your ability to safely install your flat panel display, contact your retailer about professional installation.
- Make sure the wall where you are mounting the display is appropriate. Some wall mounts are not designed to be mounted to walls with steel studs or old cinder block construction. If you are unsure, contact a professional installer.
- A minimum of two people are required for installation. Flat panel displays can be heavy.

**The American Academy of Pediatrics discourages television viewing for children younger than two years of age.**

# Accessories/Optional Accessory

## Accessories

Check you have all the items shown.

### Accessories

- Remote Control Transmitter
- N2QAYB000485



- Batteries for the Remote Control Transmitter (2)
- AA Battery

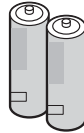

- Operating Instructions

- Pedestal
- TBL2AX0032 (TH-32LRU30)
- TBL2AX0048 (TH-37LRU30)
- TBL2AX0049 (TH-42LRU30)

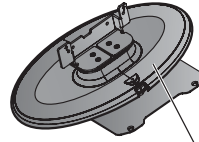

How to assemble (p. 8)

### Optional Accessory

- Wall-hanging bracket**
- TY-WK3L2RW

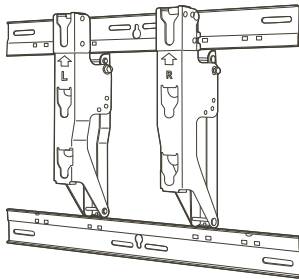

Please contact your nearest Panasonic dealer to purchase the recommended wall-hanging bracket. For additional details, please refer to the wall-hanging bracket installation manual.

#### Back of the TV

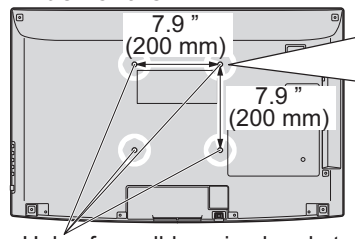

Holes for wall-hanging bracket installation

Screw for fixing the TV onto the wall-hanging bracket (not supplied with the TV)

**Depth of screw:**  
 Minimum: 0.39" (10.0 mm)  
 Maximum: 0.47" (12.0 mm)(32"/37")  
 1.57" (40.0 mm) (42")



(View from the side)

#### WARNING

- Customer assumes liability if mounting the unit themselves or if a Panasonic bracket is not used. Any damage resulting from not having a professional installer mount your unit will void your warranty.
- Always be sure to ask a qualified technician to perform any necessary set-up. Incorrect fitting may cause equipment to fall, resulting in injury and product damage.
- Do not mount the unit directly below ceiling lights (such as spotlights, floodlights or halogen lights) which typically give off high heat. Doing so may warp or damage plastic cabinet parts.
- Take care when fixing wall brackets to the wall. Always ensure that there are no electrical cables or pipes in the wall before hanging bracket.
- When using an angled-type wall hanging bracket, please ensure that there is sufficient space for the connecting cables so that they do not press against the wall when the TV is tilted forward.
- For safety reasons, remove units no longer being used from their wall-mounted locations.

## Installing the remote's batteries

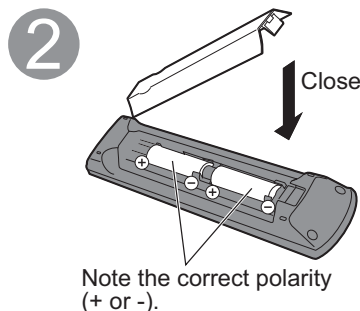
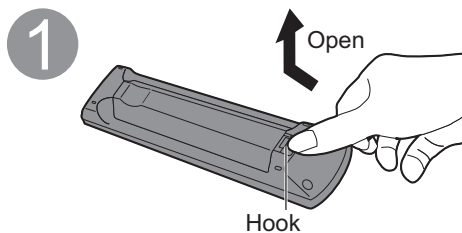

#### Caution

- Incorrect installation may cause battery leakage and corrosion, resulting in damage to the remote control.
  - Do not mix old and new batteries.
  - Do not mix different battery types (such as alkaline and manganese batteries).
  - Do not use rechargeable (Ni-Cd) batteries.
- Do not burn or break batteries.

# Accessories/Optional Accessory (Continued)

## Attaching the pedestal to TV

### Assembling the pedestal

- Fix securely with assembly screws (A). (Total 4 screws)
- Tighten screws firmly.

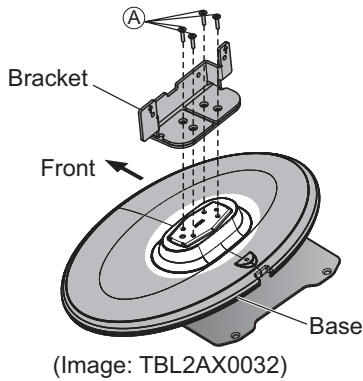

### Set-up

- Fix securely with assembly screws (B). (Total 4 screws)
- Tighten screws firmly.

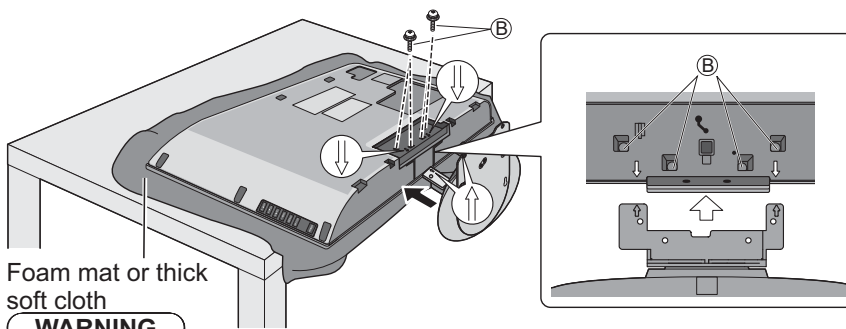

### Do not disassemble or modify the pedestal.

- Otherwise the TV may fall over and become damaged, and personal injury may result.

### Caution

### Do not use any other TV and displays.

- Otherwise the TV may fall over and become damaged, and personal injury may result.

### Do not use the pedestal if it becomes warped or physically damaged.

- If you use the pedestal when it is physically damaged, personal injury may result. Contact your nearest Panasonic Dealer immediately.

### During set-up, make sure that all screws are securely tightened.

- If sufficient care is not taken to ensure screws are properly tightened during assembly, the pedestal will not be strong enough to support the TV, and it might fall over and become damaged, and personal injury may result.

### Accessories

Assembly screws  
(4 of each)



XSS4+16FJK  
M4 × 16



THE2AC004J  
M4 × 12

Bracket (1)

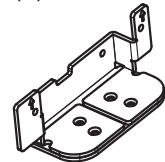

Base (1)

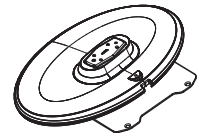

### Reference of connection

#### Antenna terminal

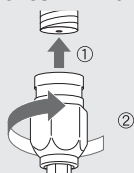

- Firmly tighten by hand.

#### Pin terminals

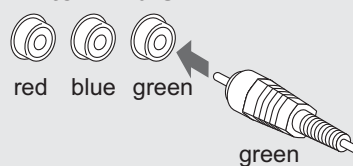

- Match colors of plugs and terminals.
- Insert firmly.

#### HDMI terminal

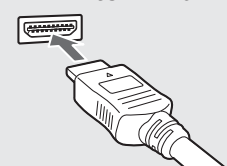

- Insert firmly.



## Location

Place the TV at a comfortable distance for viewing. Avoid placing it where sunlight or other bright light (including reflections) will fall on the screen. Use of some types of fluorescent lighting can reduce remote control transmitter range. Adequate ventilation is essential to prevent an internal component failure. Keep away from areas of excessive heat or moisture.

### Adjust the stand to your desired angle.

The stand angle can be rotate 30°/60°/90° to the right/left. (see Control rotation angle)

[Rotation angle: 30°]

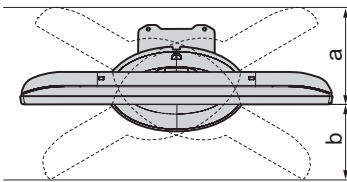

- TH-32LRU30 a: 9.8" (248 mm)  
b: 7.6" (193 mm)
- TH-37LRU30 a: 11.0" (279 mm)  
b: 8.8" (222 mm)
- TH-42LRU30 a: 12.5" (316 mm)  
b: 9.8" (248 mm)

[Rotation angle: 60°]

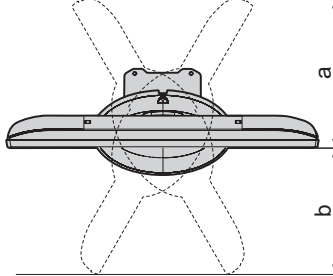

- TH-32LRU30 a: 15.0" (381 mm)  
b: 12.8" (323 mm)
- TH-37LRU30 a: 17.1" (433 mm)  
b: 14.7" (373 mm)
- TH-42LRU30 a: 19.0" (483 mm)  
b: 16.5" (418 mm)

[Rotation angle: 90°]

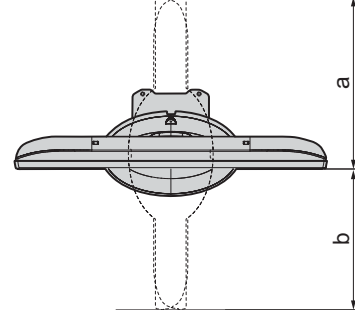

- TH-32LRU30 a: 17.3" (439 mm)  
b: 14.2" (360 mm)
- TH-37LRU30 a: 19.7" (500 mm)  
b: 16.4" (416 mm)
- TH-42LRU30 a: 21.9" (555 mm)  
b: 18.4" (467 mm)

### Control rotation angle

The rotation angle can be controlled at 30° or 60°. It is not necessary to attach the screws for the 90° angle rotation.

- ① Temporarily remove the 5 screws shown below.
- ② Attach (A) screws (2) to each angle control position.

[Bottom view]

[Front of swivel plate]

[Back of swivel plate]  
[For 30°]

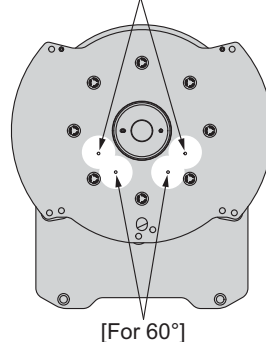
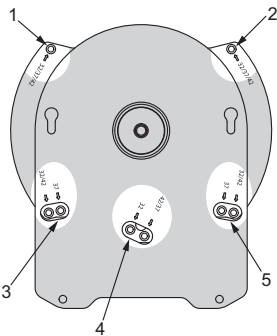
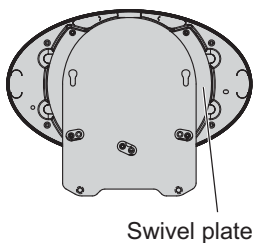

[For 60°]

### Accessories

- (A) Screws (2)  
XSN3+4FJ  
M3 × 4
- (B) Wood screw (4)  
THM2AB001
- (C) Bit (for pedestal) (1)

### Set-up

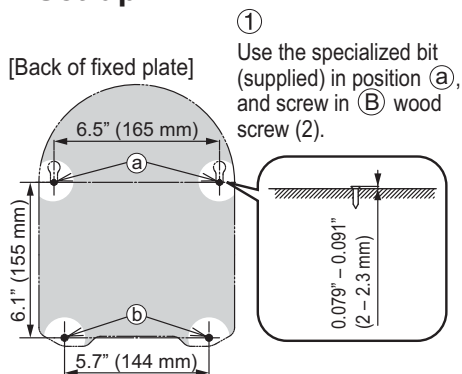

- ① Use the specialized bit (supplied) in position (a), and screw in (B) wood screw (2).

- ② Align the swivel hole in the bottom of the swivel plate with (B) wood screw that was screwed in previously, and place the TV set onto the swivel plate.

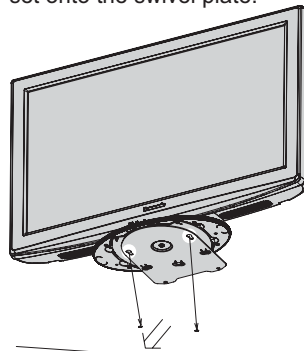

Slide the TV set forwards until it stops, then fix it in place.

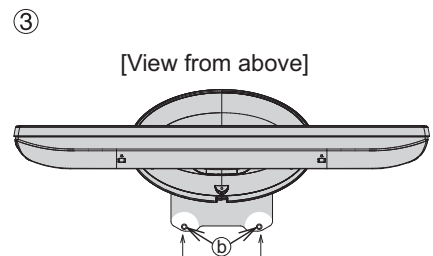

Lastly, use the (C) specialized bit to fix (B) Wood screw in place.

- Place the TV set in a position where it will not protrude from the table when swiveled.
- Make sure there is enough space between the TV set and wall, so that when the TV set is swiveled it does not hit the wall.

# Connections

## Connection panel

### Side panel

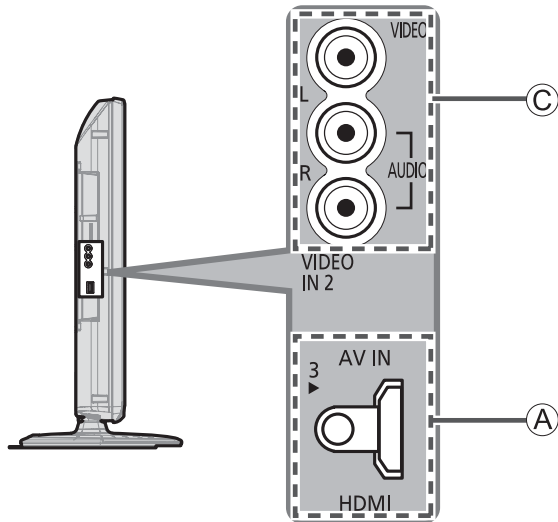

### Back panel

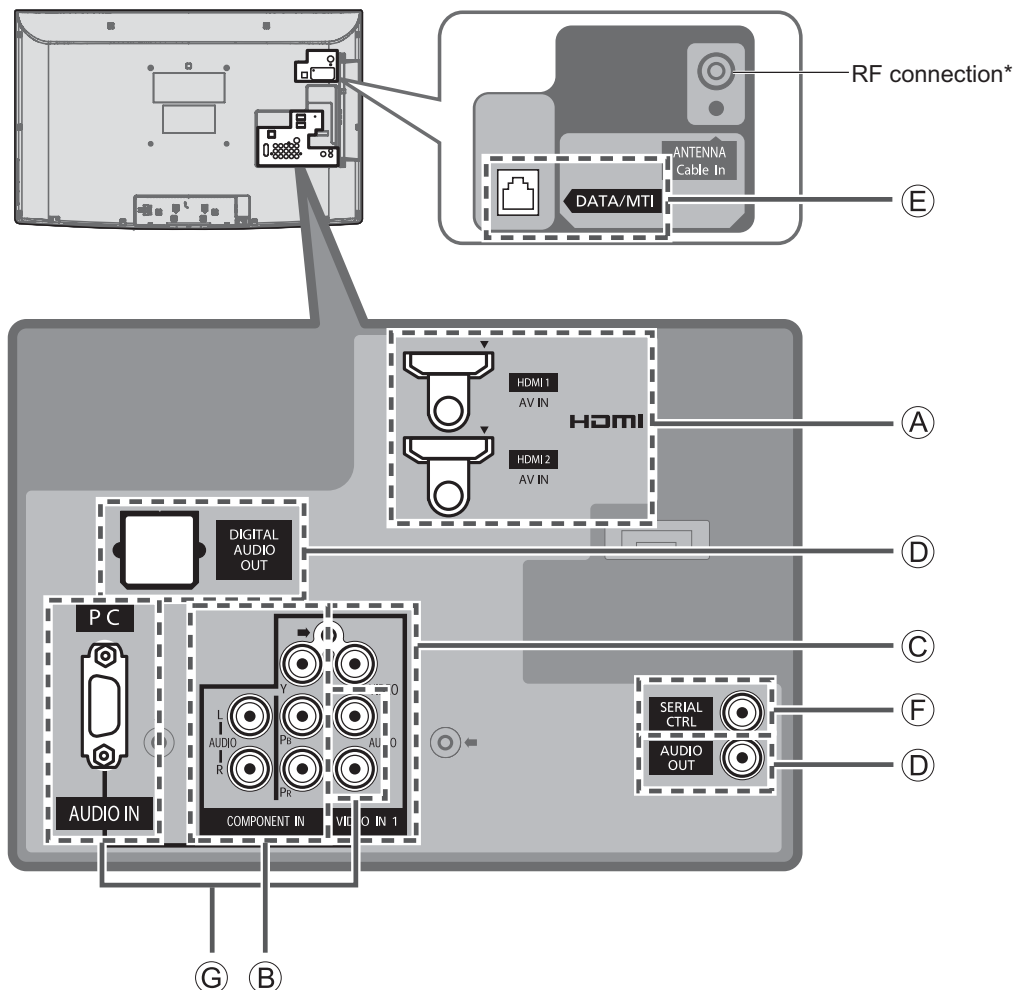

\* For more details on the external equipment's connections, please refer to the operating manuals for the equipment.

## Connecting Antenna

### VHF/UHF Antenna

- NTSC (National Television System Committee):  
Conventional broadcasting
- ATSC (Advanced Television Systems Committee):  
Digital TV Standards include digital high-definition television (HDTV), standard-definition television (SDTV), data broadcasting, multichannel surround-sound audio and interactive television.

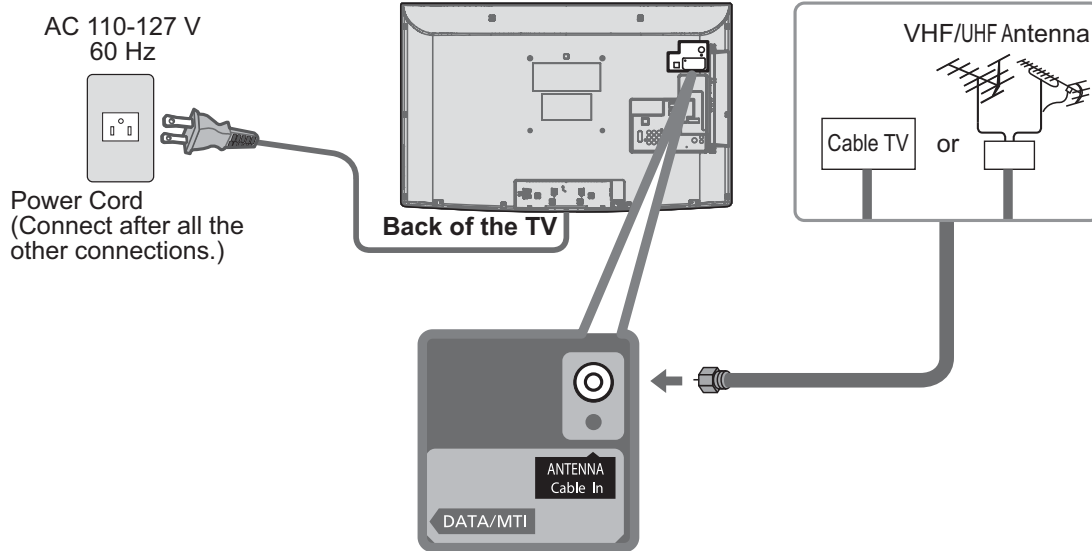

### Cable

- You need to subscribe to a cable TV service to enjoy viewing their programming.
- You can enjoy high-definition programming by subscribing to a high-definition cable service.  
The connection for high-definition can be done with the use of HDMI or Component Video cable. (see below)
- To view high-definition programming select the correct video input. (p. 15)

## Example of connections

### A To use HDMI terminals

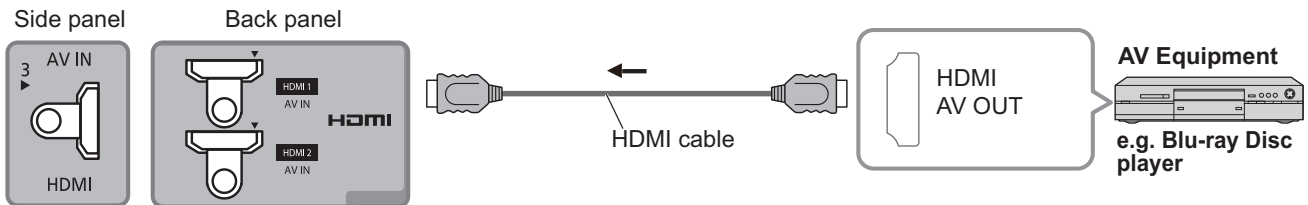

- Connecting to the HDMI terminals will enable you to enjoy high-definition digital images and high-quality sound.
- The HDMI connection is required for a 1080p signal.

### B To use COMPONENT terminals

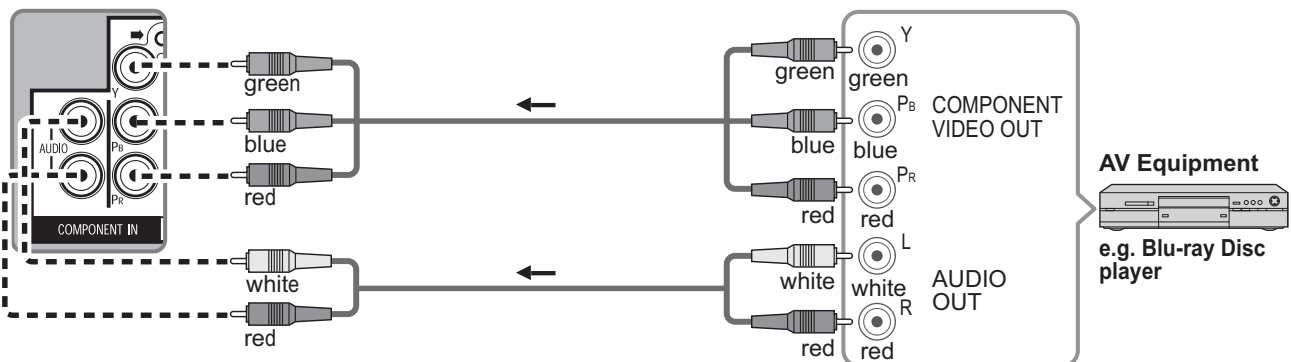

#### Note

- Not all cables and external equipment shown in this book are supplied with the TV.
- For more details on the external equipment's connections, please refer to the operating manual for the equipment.

# Connections (Continued)

## Example of connections

### C To use COMPOSITE terminals

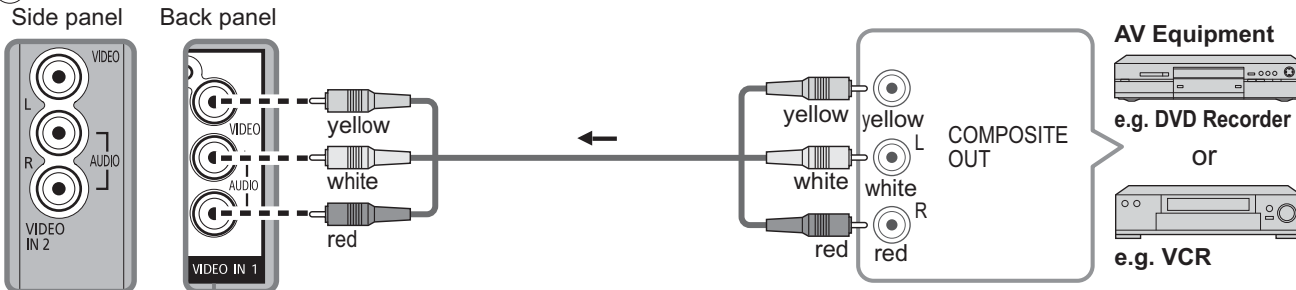

### D To use AUDIO OUT terminals

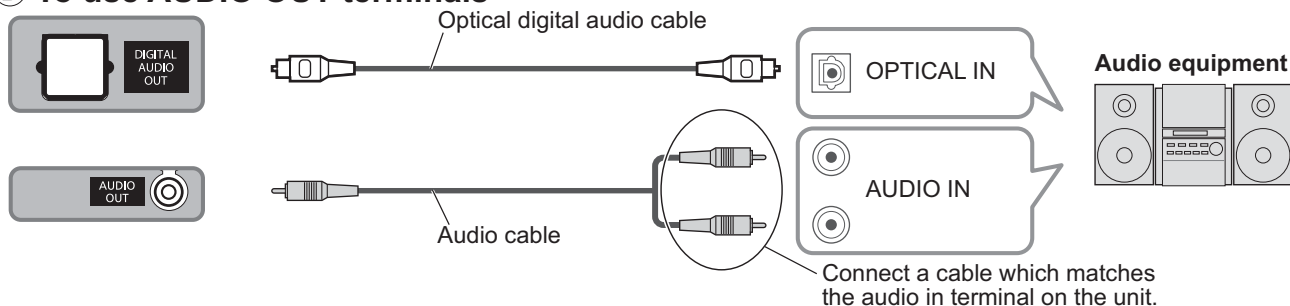

### E To use DATA/MTI terminal

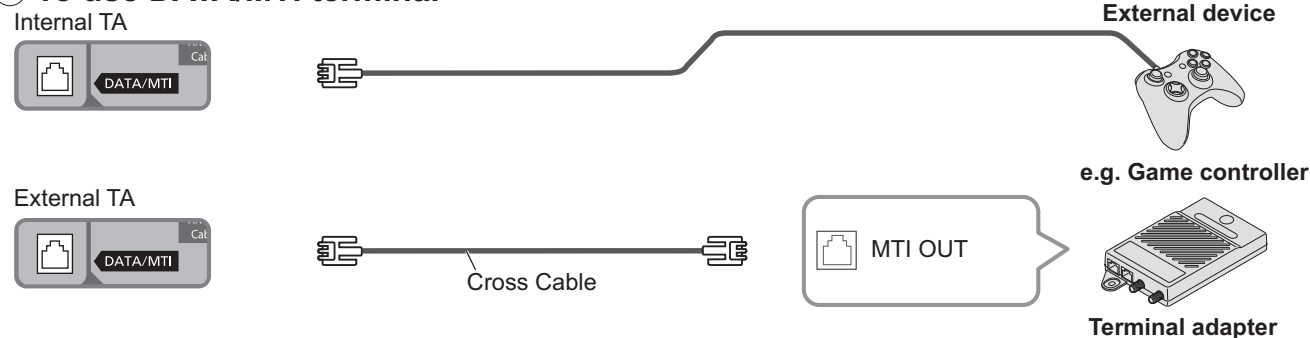

### F To use SERIAL terminal

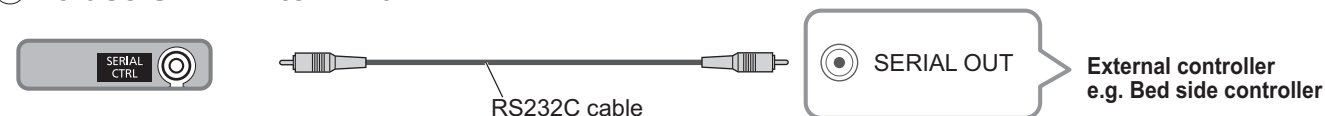

### G To use PC terminal

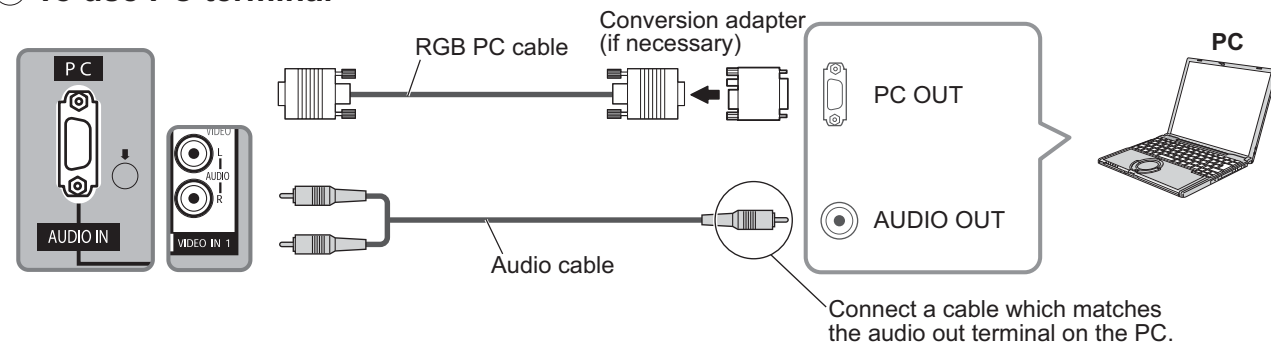

#### Note

- Not all cables and external equipment shown in this book are supplied with the TV.
- For more details on the external equipment's connections, please refer to the operating manual for the equipment.

# Identifying Controls

## TV controls/indicators

### Front of the TV

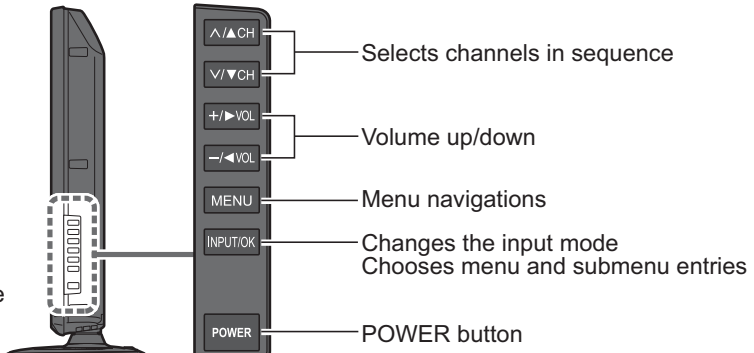
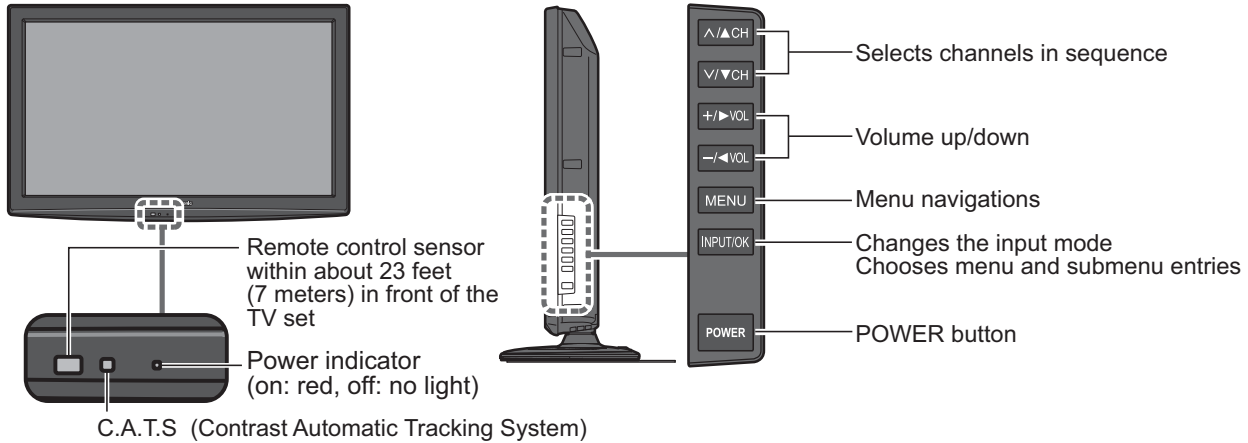

### Note

- The TV consumes a small amount of electric energy even when turned off.
- Do not place any objects between the TV remote control sensor and remote control.

## Remote control

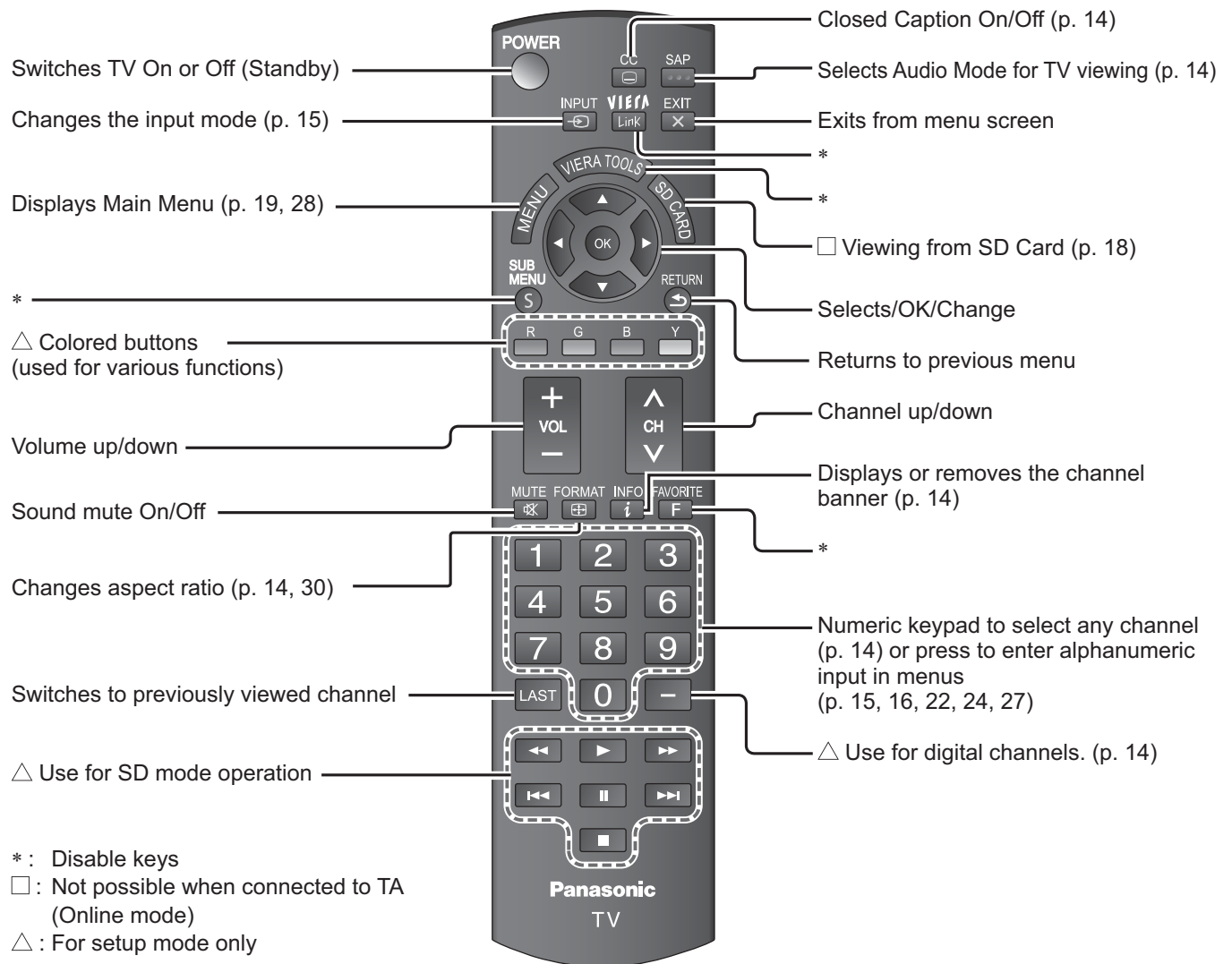

- \* : Disable keys
- : Not possible when connected to TA (Online mode)
- △ : For setup mode only

● For other Remote control, please refer to the operating manual for it.

# TV operation

Connections (p. 10-12)

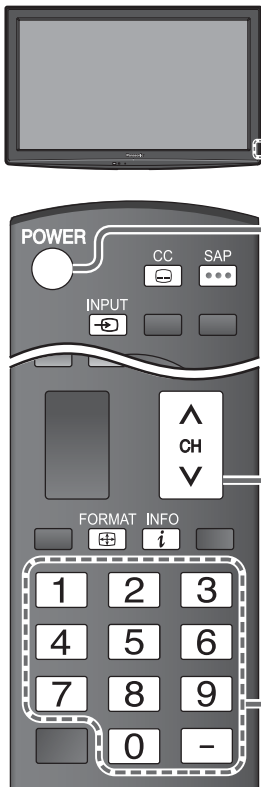

## 1 Turn the TV On with the POWER button

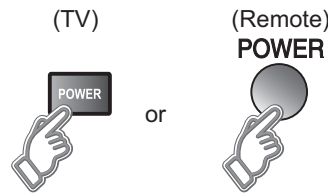

- Input select: press (p. 15)

## 2 Select a channel number

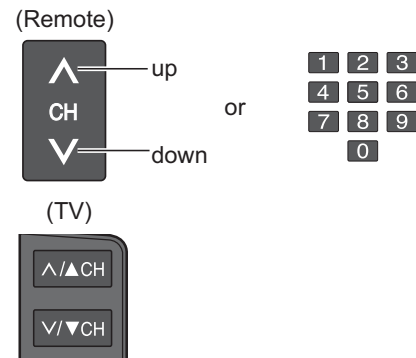

### ■ To directly enter the digital channel number

- When tuning to a digital channel, press the button to enter the minor number in a compound channel number.

example: CH15-1:

### Note

- Reselect "Cable" or "Antenna" in "ANT in" of "ANT/Cable setup" to switch the signal reception between cable TV and antenna. (p. 25)
- The channel number and volume level remain the same even after the TV is turned off.

## ■ Other Useful Functions (Operate after 2)

### Listen with SAP (Secondary Audio Program)



#### ■ Select Audio mode for watching TV

##### ● Digital mode

Press SAP to select next audio track (if available) when receiving a digital channel.

Audio track 1 of 2  
(English)

##### ● Analog mode

Press SAP to select the desired audio mode.

- Each press of SAP will change the audio mode. (Stereo/SAP/Mono)

### Closed caption



#### ■ Switches the Closed caption mode On or Off

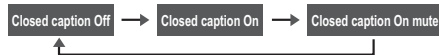

### Information recall



#### ■ Displays or removes the channel banner

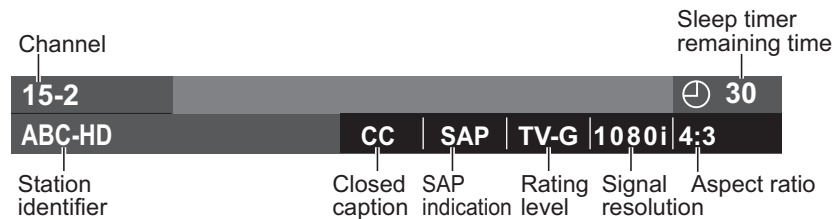

### Change aspect ratio



#### ■ Press FORMAT to cycle through the aspect modes (p. 30)

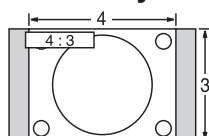

- 480i, 480p: FULL/JUST/4:3/ZOOM
- 1080p, 1080i, 720p: FULL/H-FILL/JUST/4:3/ZOOM

# Watching Videos and DVDs

If you have applicable equipment connected to the TV, you can watch videos and DVDs on the TV screen.

## Input Select

You can select the external equipment to access.

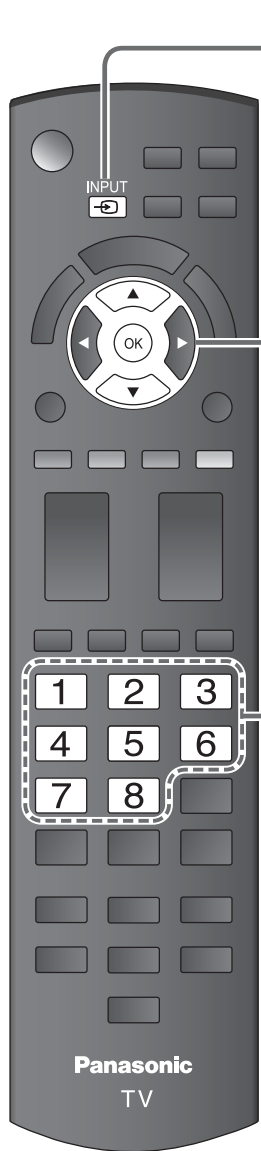

**1** With the connected equipment turned On  
**Display the Input select menu**



**2** **Select the input mode**

Input select	
1	TV
2	HDMI 1 <span style="float: right;">DVD</span>
3	HDMI 2
4	HDMI 3
5	Component <span style="float: right;">AUX</span>
6	Video 1
7	Video 2
8	PC

(example)

1	2	3
4	5	6
7	8	

or

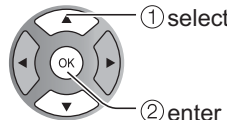

Press the corresponding NUMBER button on the remote control to select the input of your choice.

Select the input of your choice, then press OK.

- During the selection, if no action is taken for several seconds, the "Input select" menu disappears.

- The terminal and label of the connected equipment are displayed. To label each of the inputs, please refer to p. 27.



### Note

- The input label will be displayed on the "Input select" screen if the Input label is set on p. 27.
- For more details on "Input labels", refer to p. 27.

**3** **Operate the connected equipment using the remote control supplied with the equipment**

### Note

- For details, see the manual for the connected equipment.

### ■ To return to TV



# Displaying PC Screen on TV

The screen of the PC connected to the unit can be displayed on the TV.  
You can also listen to PC sound with the audio cable connected. To connect PC (p. 12)

**1 Display the Input select menu**

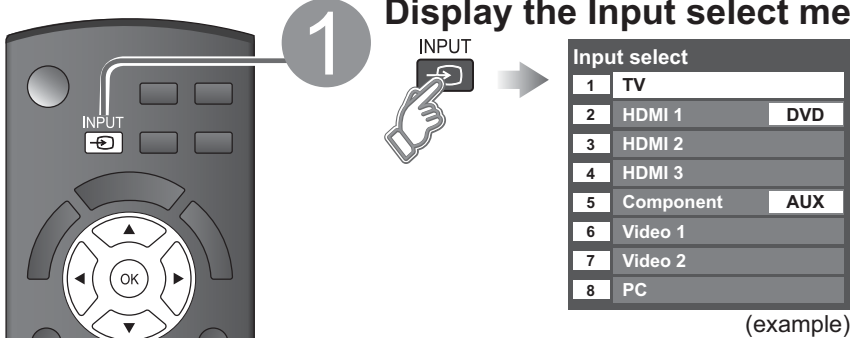

Input select	
1	TV
2	HDMI 1 DVD
3	HDMI 2
4	HDMI 3
5	Component AUX
6	Video 1
7	Video 2
8	PC

(example)

**2 Select "PC"**

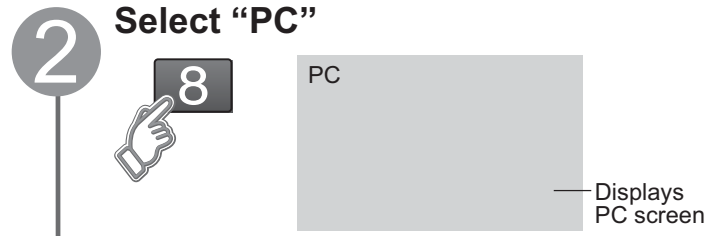

PC

Displays PC screen

● Corresponding signals (p. 33)

■ To return to TV INPUT → 1 / ^ CH v

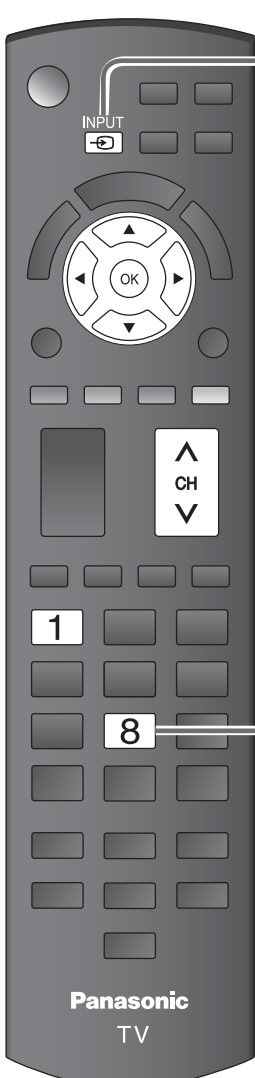

Panasonic TV



■ **PC menu setting** (change as desired)

- Making settings → "How to Use Menu Functions" 1 to 4 (p. 19)

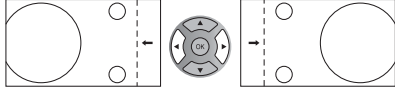
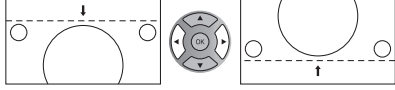
Menu	Item	Adjustments/Configurations (options)	
Picture	PC adjustments	Reset to defaults	Resets PC adjustments. Confirmation screen is displayed. Select "Yes" and press OK to reset.
		Sync	<ul style="list-style-type: none"> <li>● H &amp; V: The H and V sync signals are input from the HD/VD connector. (p. 33)</li> <li>● On green: Uses a synchronized signal on the Video G signal, which is input from the G connector. (p. 33)</li> </ul>
		Dot clock	Alleviates the problem if a picture appears to be vertically-striped, flickers partially or is blurred.
		H-position	Adjusts the horizontal position. 
		V-position	Adjusts the vertical position. 
		Clock phase	<p>Alleviates the problem if the whole picture appears to flicker or is blurred. First adjust the Dot Clock to get the best possible picture, then adjust the Clock Phase so that a clear picture appears.</p> <p><b>Note</b></p> <p>It may not be possible to display a clear picture due to poor input signals.</p>
		Input resolution	<p>Switches to wide display.</p> <ul style="list-style-type: none"> <li>● Input signal switched from 640×480 to 852×480</li> <li>● Input signal switched from 1024×768 to 1280×768 or 1366×768</li> </ul>
		H-frequency V-frequency	<p>Displays the H (Horizontal)/V (Vertical) frequencies.</p> <ul style="list-style-type: none"> <li>● Display range</li> <li>Horizontal: 15 - 110 kHz</li> <li>Vertical: 48 - 120 Hz</li> </ul>

- Audio menu (p. 20)

# Viewing from an SD card

This function that lets you easily view still images on a television by simply inserting an SD card into the SD card slot. (Media other than SD Cards will not work.)

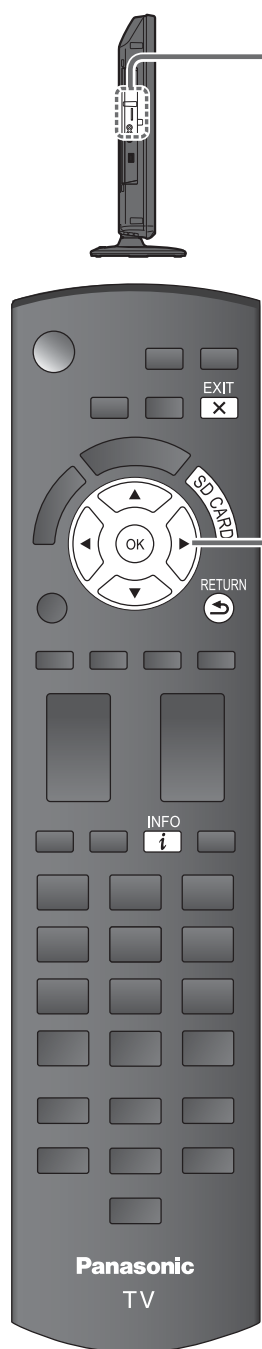

1

## Insert the SD card

- Insert the card  
Gently insert the SD Card label surface facing front.

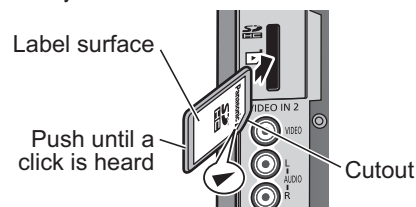

- Remove the card

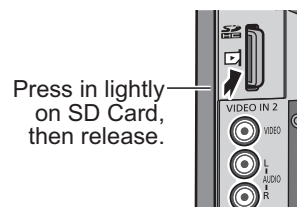

- Compliant card type (maximum capacity): SDXC Card (64 GB), SDHC Card (32 GB), microSDHC Card (16 GB), SD Card (2 GB), miniSD Card (2 GB), microSD Card (2 GB) (requiring microSDHC Card/miniSD Card/microSD Card adapter)
- If a microSDHC Card, miniSD Card or microSD Card is used, insert / remove it together with the adapter.
- For cautions and details on SD Cards (p. 31)

## Manual operation ("Image viewer auto play" is "Off") Display "Photo" (Thumbnail)



2

## Select the data to be viewed

Error display (titles that could not be loaded, etc.)

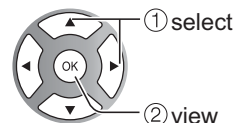

- To display/hide the Navigation area



file number / total file number

### Note

- Depending on the JPEG format, "Information" contents may not be displayed correctly. Refer to p. 31 (Data format for SD card browsing) for details.

3

## View



Displays one at a time

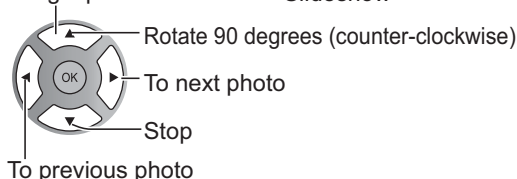
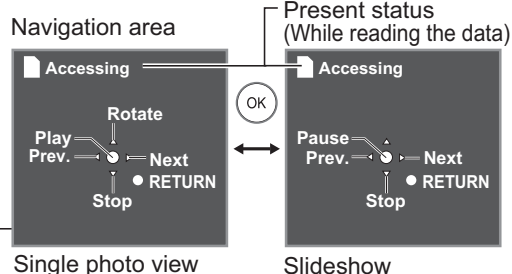

### Press to exit from a menu screen



### Press to return to the previous screen

RETURN



- To display/hide the Navigation area → INFO
- Return to the Thumbnail view → RETURN

# How to Use Menu Functions

Various menus allow you to make settings for the picture, sound, and other functions so that you can enjoy watching TV best suited for you.

- Guest menu (p. 28)

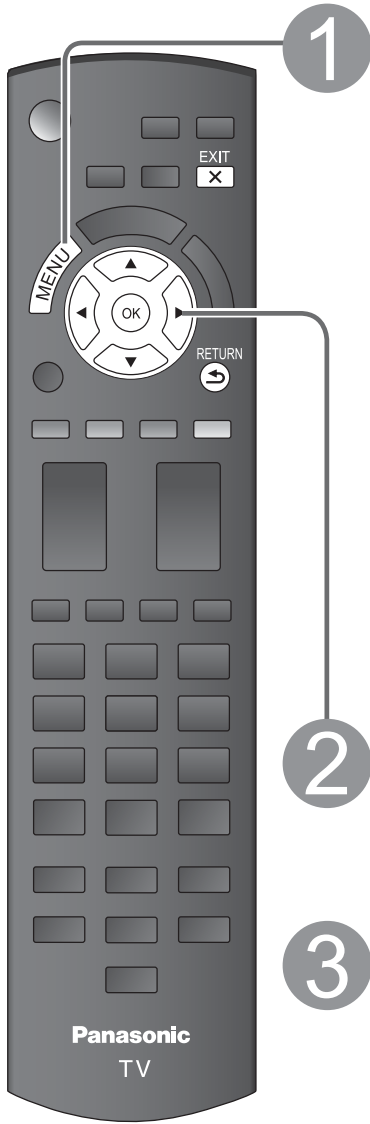

## 1 Display the menu



- Shows the functions that can be adjusted.
- Some functions will be disabled depending on the type of input signal.

### Menu structure

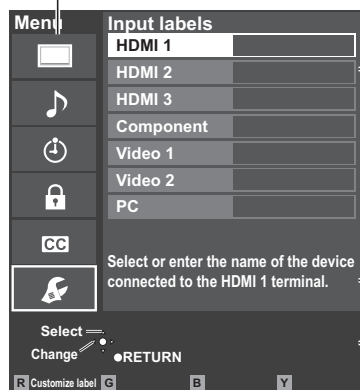

Menu bar  
Press OK to move to the Menu items.

Menu items  
Press OK to proceed to next screen if available.

Help information

Operation guide

(example: Input labels)

## 2 Select the menu

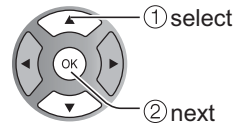
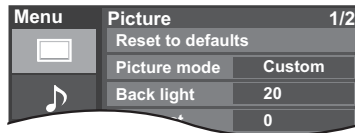

## 3 Select the item

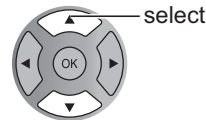
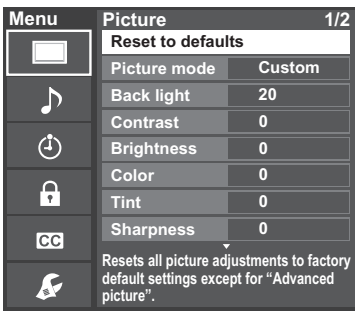

(example: Picture menu)

■ Press to exit from a menu screen



■ Press to return to the previous screen



## 4 Adjust or select

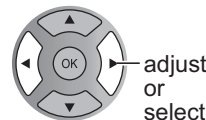
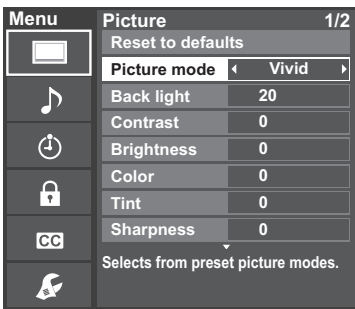

(example: Picture menu)

# How to Use Menu Functions

## ■ Menu list

Menu	Item	Adjustments/Configurations (alternatives)	
Picture	Reset to defaults*	Resets all picture adjustments to factory default settings except for "Advanced picture".	
	Picture mode	Basic picture mode ( <b>Vivid/Standard/Cinema/Custom</b> ) (p. 32)	
	Back light	Adjusts the luminance of the back light.	
	Contrast, Brightness, Color, Tint, Sharpness	Adjusts color, brightness, etc. for each picture mode to suit your taste <ul style="list-style-type: none"> <li>● Display range</li> <li><b>Contrast/Brightness/Color/Sharpness:</b>0 - 100</li> <li><b>Tint:</b> -50 - +50</li> </ul>	
	Color temp.	Selects a choice of Cool (blue), Normal, or Warm (red) color. ( <b>Cool/Normal/Warm</b> )	
	Color mgmt.	On: Enhances green and blue color reproduction, especially outdoor scenes. ( <b>Off/On</b> )	
	A.I. picture	Controls dark areas without affecting the black level or brightness in the overall picture ( <b>Off/On</b> )	
	C.A.T.S.	Adjusts the brightness and gradation according to the ambient lighting condition. ( <b>Off/On</b> )	
	Video NR	Reduces noise, commonly called snow. Leave it off when receiving a strong signal. ( <b>Off/On</b> )	
	Aspect adjustments	Screen format	Changes the format (aspect ratio). ( <b>FULL/H-FILL/JUST/4:3/ZOOM</b> ) Lets you choose the aspect depending on the format of received signal. (p. 30)
		H size	Adjusts the horizontal display range to reduce noise of both side edges of an image. ( <b>Size 1/Size 2</b> ) Size 2: Adjusts the image size according to the aspect mode for to reduce noise. (p. 32)
	PC adjustments		Sets PC display (p. 17)
	Advanced picture	3D Y/C filter	Minimizes noise and cross-color in the picture. ( <b>Off/On</b> )
		Color matrix	Selects image resolution of component-connected devices ( <b>SD/HD</b> ) <ul style="list-style-type: none"> <li>● SD: Standard Definition HD: High Definition</li> <li>● Only used with 480p video signal.</li> </ul>
		MPEG NR	Reduces noise of specific digital signals of DVD, STB, etc. ( <b>Off/On</b> )
		Black level	Selects Dark or Light. Valid only for external input signals. ( <b>Dark/Light</b> )
3:2 pulldown		Adjusts the picture recorded in 24 fps for optimum quality. ( <b>Off/On/Auto</b> )	
Audio	Reset to defaults*	Resets Bass, Treble, and Balance adjustments to factory default settings.	
	Bass	Increases or decreases the bass response.	
	Treble	Increases or decreases the treble response.	
	Balance	Emphasizes the left / right speaker volume.	
	Advanced audio	Surround	Enhances audio response when listening to stereo. ( <b>Off/On</b> )
		Volume leveler	Minimizes volume disparity after switching to external inputs.
		TV speakers	Switches to "Off" when using external speakers ( <b>Off/On</b> ) <ul style="list-style-type: none"> <li>● "Surround" and "Volume leveler" do not work if "Off" is selected.</li> </ul>
		HDMI 1 in HDMI 2 in HDMI 3 in	The default setting is "Digital" for the HDMI connection. (Digital input signal) Select audio input terminal when DVI cable is connected. (Analog audio input signal) ( <b>Digital/Component/Video 1/Video 2</b> )

● In the AV mode, the Audio and Setup menus give fewer options.

\* Confirmation screen is displayed. Select "Yes" and press OK to reset.

# (Continued)

## ■ Menu list

Menu	Item	Adjustments/Configurations (alternatives)	
<b>Timer</b>	<b>Sleep</b>	The TV can automatically turn Off at the designated time <b>(0/15/30/60/90)</b>	
<b>Lock</b>		Locks the programs. (p. 22)	
<b>Closed caption</b>	<b>Closed caption</b>	Displays subtitles (Closed caption). (p. 26)	
<b>Setup</b>	<b>ANT/Cable setup</b>	Sets channels. (p. 24)	
	<b>Connected devices</b>	<b>Input labels</b>	Selects the terminal and label of the external equipment (p. 27)
		<b>Audio out</b>	To prevent howling, stops output of audio specified in this menu. (p. 27) <b>(On/Off)</b>
	<b>ECO/energy saving</b>	<b>Power save</b>	Reduces screen brightness to lower power consumption. Eye-friendly for viewing in a dark room. <b>(Standard/Saving)</b>
		<b>No signal for 10 minutes</b>	To conserve energy, the TV automatically turns off when NO SIGNAL and NO OPERATION continue for more than 10 minutes. <b>(Stay on/Power TV off)</b> <b>Note</b> <ul style="list-style-type: none"> <li>• “No signal for 10 minutes was activated” will be displayed for about 10 seconds when the TV is turned on for the first time after the power was turned off by “No signal for 10 minutes”.</li> <li>• The on-screen display will flash 3, 2 and 1 to indicate the last three (3) remaining minutes prior to the shut-off.</li> </ul>
		<b>No activity for 3 hours</b>	To conserve energy, the TV automatically turns off when no operation of remote and side panel key continues for more than 3 hours. <b>(Stay on/Power TV off)</b> <b>Note</b> <ul style="list-style-type: none"> <li>• Not in use while “PC input” is selected.</li> <li>• “No activity for 3 hours was activated” will be displayed for about 10 seconds when the TV is turned on for the first time after the power was turned off by “No activity for 3 hours”.</li> <li>• The on-screen display will flash 3, 2 and 1 to indicate the last three (3) remaining minutes prior to the shut-off.</li> </ul>
	<b>Advanced setup</b>	<b>Image viewer auto play</b>	Set “Thumbnail” to play back SD cards automatically. <b>(Photos/Off)</b>
		<b>About</b>	Displays TV version and software license.
		<b>Reset to defaults</b>	Performing Reset will clear all items set with Setup, such as channel settings.

● How to Use Menu Functions  
(picture, sound quality, etc.)

Advanced

# Lock

You can lock specified channels or shows to prevent children from watching objectionable content.

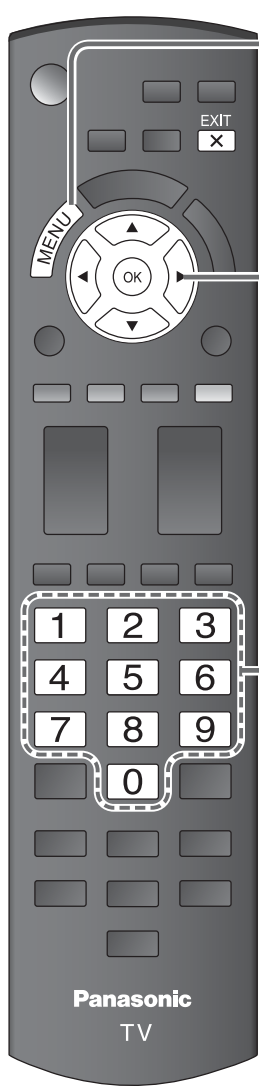

## 1 Display the menu



## 2 Select "Lock"

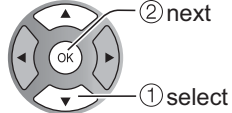

You will be asked to enter your password each time you display the Lock menu.

## 3 Input your 4-digit password

A 4-digit code must be entered to view a blocked program or change rating settings.



- If it is your first time entering the password, enter the password twice in order to register it.

## 4 Select the Lock mode

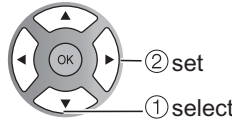
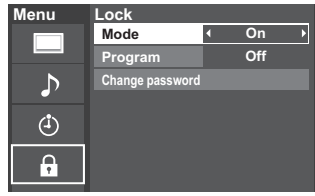

- Off: Unlocks all the lock settings of "Program".
- On: Locks all the inputs regardless of the lock settings of "Program".

### ■ Press to exit from a menu screen



#### Caution

- Make a note of your password in case you forget it. (If you have forgotten your password, consult your local dealer.)

#### Note

- When you select a locked channel, a message will be displayed that allows you to view the channel if you input your password.

## 5 Select the item

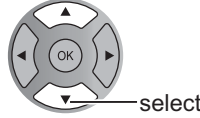
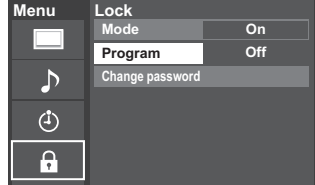

## 6 Set

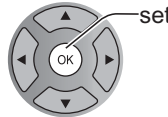

■ To select the channel or the rating of the program to lock

■ To set a rating level

“V-chip” technology enables restricted shows to lock according to TV ratings.

① Select “Mode” and set to “On”

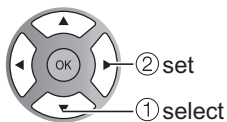
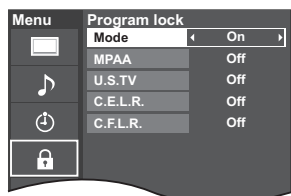

② Select the rating category you wish to follow

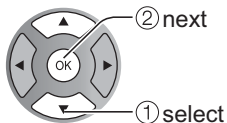
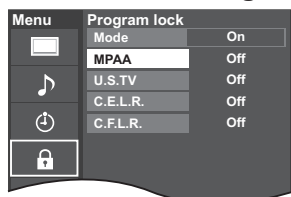

MPAA: U.S. movie ratings  
 U.S.TV: U.S. TV program ratings  
 C.E.L.R.: Canadian English ratings  
 C.F.L.R.: Canadian French ratings

③ Select the rating to lock

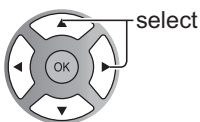

Example of “MPAA” (U.S. movie ratings)

NR	No rating
G	General Audience: All ages admitted
PG	Parental Guidance Suggested
PG-13	Parents Strongly Cautioned: Inappropriate for children under 13
R	Restricted: Under 17 requires accompanying parent or adult guardian
NC-17	No one 17 and under admitted
X	Adults only

● To get more information (p. 29)

■ To change the password

① In ④, select “Change password” and press OK

② Input the new 4-digit password twice

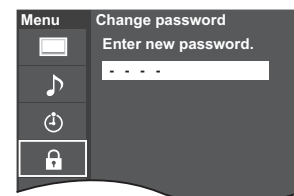
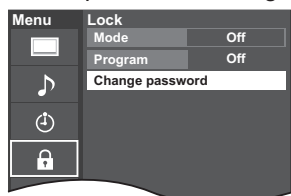

Program lock

Change password

**Note**

- This television is designed to support the “Downloadable U.S. Region Rating System” when available. (Available only in U.S.A.)
- The Off rating is independent of other ratings.
- When placing a lock on a specific-age-based-rating level, the Off rating and any other more restrictive ratings will also be blocked.

# Editing and Setting Channels

The current channel settings can be changed according to your needs and reception conditions.

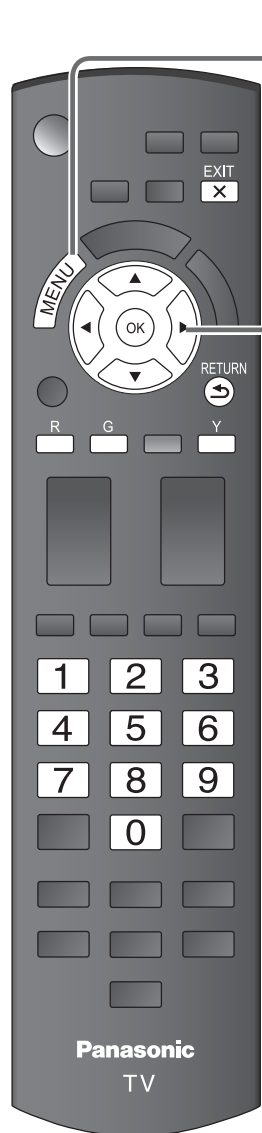

## 1 Display the menu



## 2 Select "Setup"

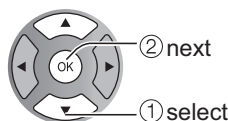
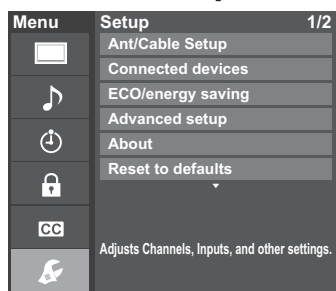

## 3 Select "ANT/Cable setup"

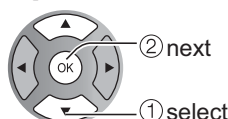
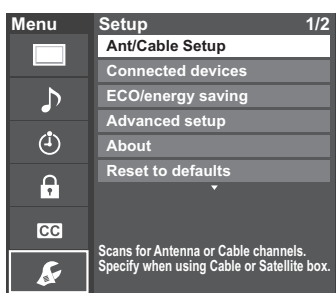

## 4 Select the function

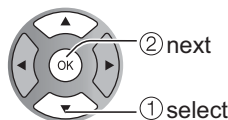
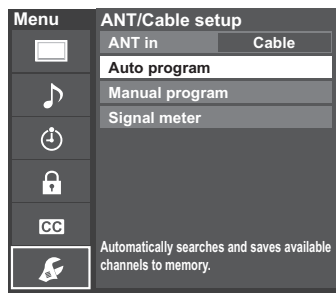

■ Press to exit from a menu screen



## 5 Set

**Auto program**  
Set automatically

**Manual program**  
Set manually

**Signal meter**  
Check signal strength

### ■ To reset the settings of the Setup menu

- ① Select "Reset to defaults" in the Setup menu (2) and press OK
- ② Input your 4-digit password with number buttons
- ③ Select "YES" on the confirmation screen and press OK



Automatically searches and adds available channels to the memory.

① Select "ANT in"

- ➔ Select "Cable" or "Antenna"
- Or select "Not used".

② Select "Auto program"

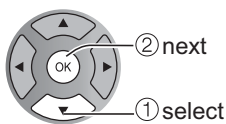
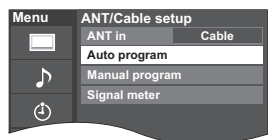

③ Start scanning the channels

(Available channels are automatically set.)

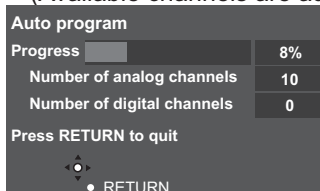

- After the scanning is completed, select "Apply". (see below ⑤).
- All previously saved channels are erased.

Use this procedure when changing the channel setup or changing the channel display. Also, use this to add or skip channels from the channel list manually.

① Select "Edit"

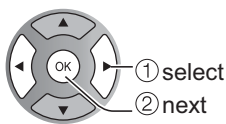
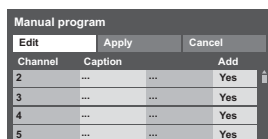

② Select the item to edit

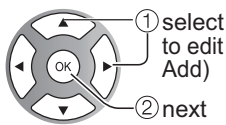
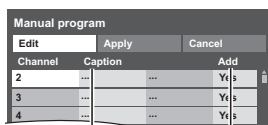

- Caption: Changes the station identifier
- Add: Adds or skips channels

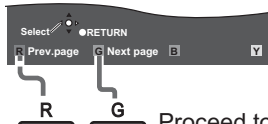

Proceed to next page  
Go back to the previous page

③ Edit

● Caption

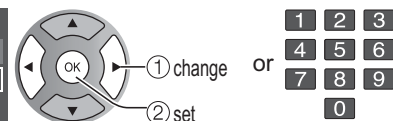
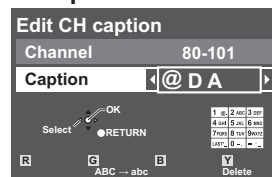

Caption

Select or edit the station identifier. (maximum 7 characters available)

● Add

Press OK to select "Yes (add)" or "No (skip)"

④ Move the cursor to a channel number

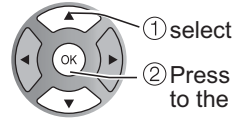
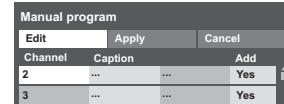

⑤ Select "Apply"

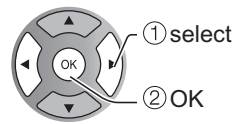
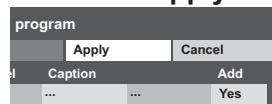

To cancel the Edit

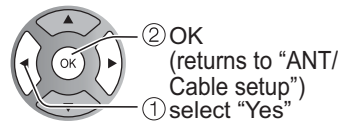
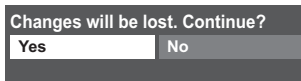
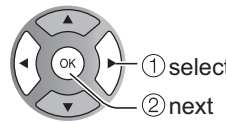
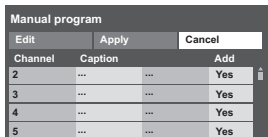

Check the signal strength if interference is found or freezing occurs on a digital image.

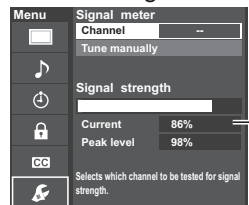

- If the signal is weak, check the antenna. If no problem is found, consult your local dealer.

Note

- Not available if "Cable" is selected in "ANT in" (see above).
- Available only for digital antenna channels.

- If "Lock" (p. 22) is activated and "ANT/Cable setup" is selected, "Enter password." will be displayed.

# Closed Caption

**1 Display the menu**



**2 Select "Closed caption"**

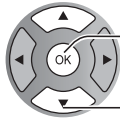

■ Press to exit from a menu screen



Menu	Closed caption
	Reset to defaults
	Mode On
	Analog CC1
	Digital Primary
	Digital setting
CC	Display broadcast TV's Closed Caption (CC) text when available.

The television includes a built-in decoder that is capable of providing a text display of the audio. The program being viewed must be transmitting the Closed Caption (CC) information. (p. 30)

## ■ Select the item and set

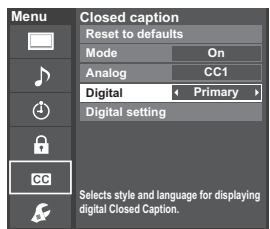
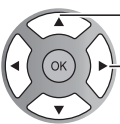
① select  
② set

**Mode** On: To display Closed captions.  
CC on mute: To display Closed captions when the audio is muted. (when not using, select "Off").

**Analog** (Choose the Closed caption service of Analog broadcasting.)

CC1-4: Information related to pictures (Appears at the bottom of the screen)

T1-4: Textual information (Appears over the entire screen)

**Digital** (The Digital Closed caption menu lets you configure the way you choose to view the digital captioning.)

Select the setting.

- "Primary", "Second.", "Service 3", "Service 4", "Service 5", "Service 6"

- The settings in "Analog" or "Digital" depend on the broadcaster.

## ■ To make more in-depth display settings in digital programs

- ① Select "Digital setting" and press OK
- ② Select the item and set

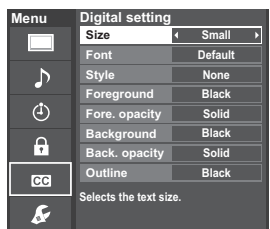
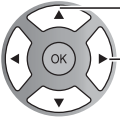
① select  
② set

**Size** Text size

**Font** Text font

**Style** Text style (Raised, Depressed, etc.)

**Foreground** Color of text

**Fore. opacity** Opacity of text

**Background** Color of text box

**Back. opacity** Opacity of text box

**Outline** Outline color of text (Identify the setting options on the screen.)

## ■ To reset the settings

- ① Select "Reset to defaults". Confirmation screen is displayed.
- ② Select "Yes" and press OK.

### Closed caption

### Display Closed caption

# Input Labels

- 1 Display the menu**
- 2 Select "Setup"**  

Menu	Setup	1/2
	Ant/Cable Setup	
	Connected devices	
	ECO/energy saving	
	Advanced setup	
	About	
	Reset to defaults	
	Adjusts Channels, Inputs, and other settings.	
- 3 Select "Connected devices"**  

Menu	Setup	1/2
	Ant/Cable Setup	
	<b>Connected devices</b>	
	ECO/energy saving	
	Advanced setup	
	About	
	Reset to defaults	
	Customize TV inputs with the names of your connected devices. For easier input selections.	
- 4 Select "Input labels" or "Audio out"**  

Connected devices	
<b>Input labels</b>	
Audio out	

■ Press to exit from a menu screen

## Input labels

### Display labels of Connected devices

Devices connected to external input terminals can be labeled for easier identification during the input selection. (In selecting the input mode from p. 15 ②)

#### ■ Select the terminal and label of the external equipment

Menu	Input labels
	HDMI 1
	HDMI 2
	HDMI 3
	Component
	Video 1
	Video 2
	PC
	Select or enter the name of the device connected to the HDMI 1 terminal.

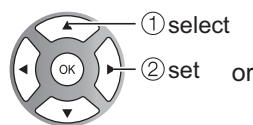

PC	@AD
CC	
	Select if a computer is connected to the TV's PC input.
	OK
Select	RETURN
	1 ok 2 set 3 out
	4 ok 5 set 6 out
	7 ok 8 set 9 out
	Last 0 ok --X
	ABC→ abc B Delete

Follow the instructions on screen to complete the following operations.

- Terminals: HDMI 1-3/Component/Video 1-2/PC
- Label: [BLANK] Not used/Blu-ray/DVD/DVD REC/HOME THTR/ GAME/COMPUTER/VCR/CABLE/SATELLITE/DVR/CAMERA/ MONITOR/AUX/RECEIVER/MEDIA CTR/MEDIA EXT/OTHER
- For the PC terminal, only "Not used" is available.
- If "Not used" is selected, the INPUT button press will skip its input.
- Each selected label will be displayed on the "Input select" screen. (p. 15)

Label Terminal



[example]

To prevent howling, stops output of audio specified in this menu. (p. 21)

#### ■ Select the terminal and set "Off"

Audio out	
HDMI 1	On
HDMI 2	On
HDMI 3	On
Component	On
<b>Video 1</b>	<b>Off</b>
Video 2	On
Video 3	On

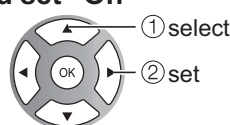

## Audio out

### Stop output of the audio

# Guest Menu

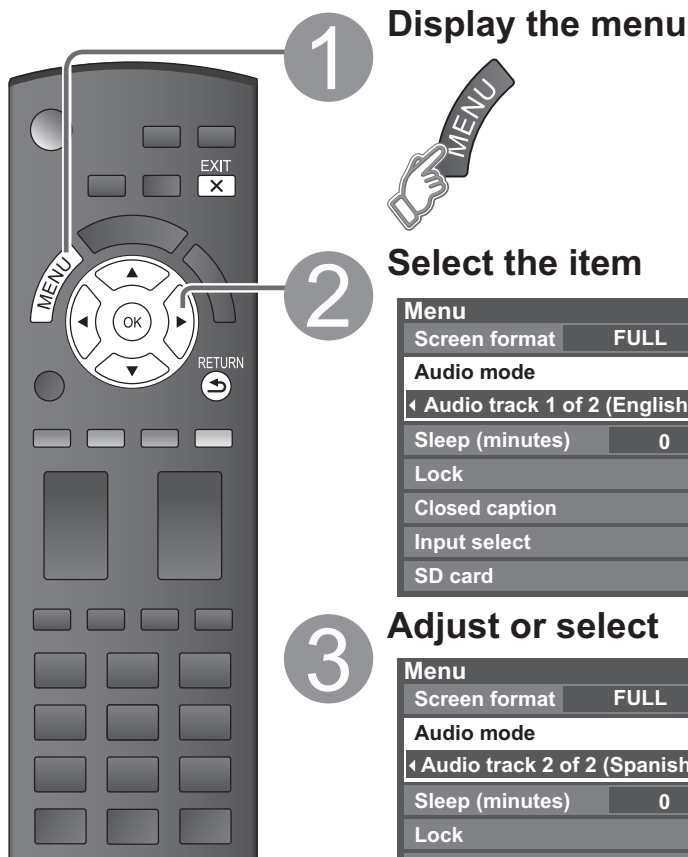

- Shows the functions that can be adjusted.
- Some functions will be disabled depending on the type of input signal.

■ Press to exit from a menu screen



Menu	
Screen format	FULL
<b>Audio mode</b>	
◀ Audio track 1 of 2 (English) ▶	
Sleep (minutes)	0
Lock	
Closed caption	
Input select	
SD card	

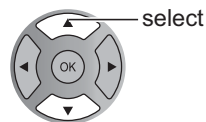

Menu	
Screen format	FULL
<b>Audio mode</b>	
◀ Audio track 2 of 2 (Spanish) ▶	
Sleep (minutes)	0
Lock	
Closed caption	
Input select	
SD card	

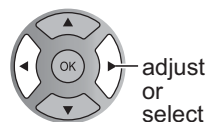

## ■ Guest menu

Item	Adjustments/Configurations (alternatives)
<b>Screen format</b>	Changes the format (aspect ratio). <b>(FULL/H-FILL/JUST/4:3/ZOOM)</b> Lets you choose the aspect depending on the format of received signal. (p. 30)
<b>Audio mode</b>	Select Audio mode (p. 14)
<b>Sleep (minutes)</b>	The TV can automatically turn Off at the designated time <b>(0/15/30/60/90)</b>
<b>Lock</b>	Locks the programs. (p. 22)
<b>Closed caption</b>	Displays subtitles (Closed caption). (p. 26)
<b>Input select</b>	Select Input (p. 15)
<b>SD card</b>	Displays Photo viewer (p. 18)

# Ratings List for Lock

“V-chip” technology enables you to lock channels or shows according to standard ratings set by the entertainment industry. (p. 23)

## ■ U.S. MOVIE RATINGS (MPAA)

NR	NO RATING (NOT RATED) AND NA (NOT APPLICABLE) PROGRAMS. Movie which has not been rated or where rating does not apply.
G	GENERAL AUDIENCES. All ages admitted.
PG	PARENTAL GUIDANCE SUGGESTED. Some material may not be suitable for children.
PG-13	PARENTS STRONGLY CAUTIONED. Some material may be inappropriate for children under 13.
R	RESTRICTED. Under 17 requires accompanying parent or adult guardian.
NC-17	NO ONE 17 AND UNDER ADMITTED.
X	ADULTS ONLY.

## ■ U.S. TV PROGRAMS RATINGS (U. S. TV)

Age-based Group	Age-based Ratings	Possible Content Selections	Description
NR (Not Rated)	TV-NR	<ul style="list-style-type: none"> <li>● Viewable</li> <li>● Blocked</li> </ul>	Not Rated.
Youth	TV-Y	<ul style="list-style-type: none"> <li>● Viewable</li> <li>● Blocked</li> </ul>	All children. The themes and elements in this program are specifically designed for a very young audience, including children from ages 2-6.
	TV-Y7	<ul style="list-style-type: none"> <li>● FV Blocked</li> <li>● Viewable</li> <li>● Blocked</li> </ul>	Directed to older children. Themes and elements in this program may include mild physical or comedic violence, or may frighten children under the age of 7.
Guidance	TV-G	<ul style="list-style-type: none"> <li>● Viewable</li> <li>● Blocked</li> </ul>	General audience. It contains little or no violence, no strong language, and little or no sexual dialogue or situations.
	TV-PG	<ul style="list-style-type: none"> <li>● D,L,S,V (all selected)</li> <li>● Any combination of D, L, S, V</li> </ul>	Parental guidance suggested. The program may contain infrequent coarse language, limited violence, some suggestive sexual dialogue and situations.
	TV-14	<ul style="list-style-type: none"> <li>● D,L,S,V (all selected)</li> <li>● Any combination of D, L, S, V</li> </ul>	Parents strongly cautioned. This program may contain sophisticated themes, sexual content, strong language and more intense violence.
	TV-MA	<ul style="list-style-type: none"> <li>● L,S,V (all selected)</li> <li>● Any combination of L, S, V</li> </ul>	Mature audiences only. This program may contain mature themes, profane language, graphic violence, and explicit sexual content.

FV: Fantasy/Cartoon Violence. V: Violence S: Sex L: Offensive Language D: Dialogue with sexual content.

## ■ CANADIAN ENGLISH RATINGS (C. E. L. R.)

E	Exempt - Exempt programming includes: news, sports, documentaries and other information programming, talk shows, music videos, and variety programming.
C	Programming intended for children under age 8. No offensive language, nudity or sexual content.
C8+	Programming generally considered acceptable for children 8 years and over. No profanity, nudity or sexual content.
G	General programming, suitable for all audiences.
PG	Parental Guidance suggested. Some material may not be suitable for children.
14+	Programming contains themes or content which may not be suitable for viewers under the age of 14. Parents are strongly cautioned to exercise discretion in permitting viewing by pre-teens and early teens.
18+	18+ years old. Programming restricted to adults. Contains constant violence or scenes of extreme violence.

## ■ CANADIAN FRENCH RATINGS (C. F. L. R.)

E	Exempt - Exempt programming.
G	General - Programming intended for audience of all ages. Contains no violence, or the violence content is minimal or is depicted appropriately.
8 ans+	8+ General - Not recommended for young children. Programming intended for a broad audience but contains light or occasional violence. Adult supervision recommended.
13 ans+	Programming may not be suitable for children under the age of 13 - Contains either a few violent scenes or one or more sufficiently violent scenes to affect them. Adult supervision strongly suggested.
16 ans+	Programming may not be suitable for children under the age of 16 - Contains frequent scenes of violence or intense violence.
18 ans+	Programming restricted to adults. Contains constant violence or scenes of extreme violence.

### Caution

- The V-Chip system that is used in this set is capable of blocking “NR” programs (non rated, not applicable and none) as per FCC Rules Section 15.120(e)(2). If the option of blocking “NR” programs is chosen “unexpected and possibly confusing results may occur, and you may not receive emergency bulletins or any of the following types of programming.”
  - Emergency Bulletins (Such as EAS messages, weather warnings and others)
  - Locally originated programming • News • Political • Public Service Announcements • Religious • Sports • Weather

# Technical Information

## Closed caption (CC)

- For viewing the CC of digital broadcasting, set the aspect to FULL (If viewing with H-FILL, JUST, ZOOM or 4:3; characters might be cut off).
- The CC can be displayed on the TV if the receiver (such as a set-top box or satellite receiver) has the CC set On using the Component or HDMI connection to the TV.
- If the CC is set to On on both the receiver and TV when the signal is 480i (except for the HDMI connection), the CC may overlap on the TV.
- If a digital program is being output in analog format, the CC data will also be output in analog format.
- If the recorder or output monitor is connected to the TV, the CC needs to be set up on the recorder or output monitor.
- EIA-708 is the standard for closed captioning for ATSC digital television streams in the United States and Canada.
- EIA-608, also known as line 21 captions, used to be the standard for closed captioning for NTSC TV broadcasts in the United States and Canada.

## Aspect Ratio (FORMAT)

Press the FORMAT button to cycle through the aspect modes. This lets you choose the aspect depending on the format of the received signal and your preference. (p. 14)  
(e.g.: in case of 4:3 image)

### ● FULL

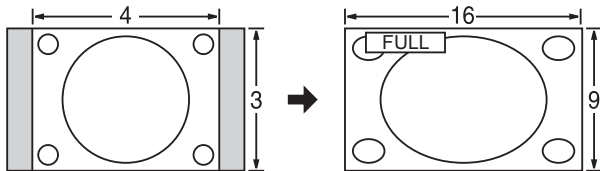

Enlarges the 4:3 image horizontally to the screen's side edges. (Recommended for anamorphic picture)

### ● JUST

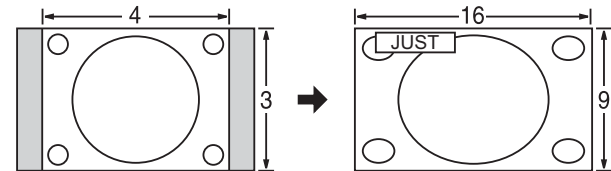

Stretches to justify the 4:3 image to the four corners of the screen. (Recommended for normal TV broadcast)

### ● H-FILL

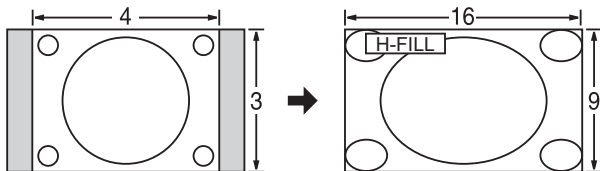

Enlarges the 4:3 image horizontally to the screen's side edges. The side edges of the image are cut off.

### ● 4:3

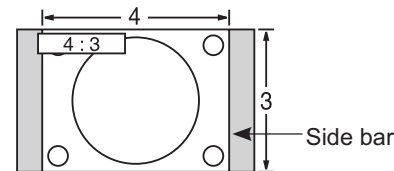

Standard  
(Note that "Image retention" of the side bar may occur from displaying it for a long time.)

### ● ZOOM

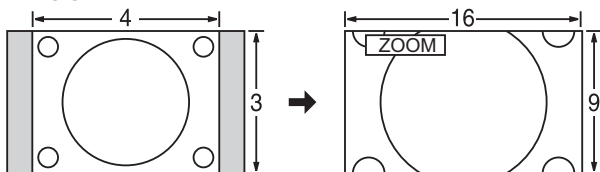

Enlarges the 4:3 image to the entire screen. (Recommended for Letter Box)

### Note

- 480i (4:3), 480i (16:9), 480p (4:3), 480p (16:9): FULL, JUST, 4:3 or ZOOM
- 1080p / 1080i / 720p: FULL, H-FILL, JUST, 4:3 or ZOOM

### ● Zoom adjustments

Vertical image position and size can be adjusted in "ZOOM".

① Select "Zoom adjustments" on the "Picture" menu. (p. 20)

② V-position: Vertical position adjustment

③ V-size: Vertical size adjustment

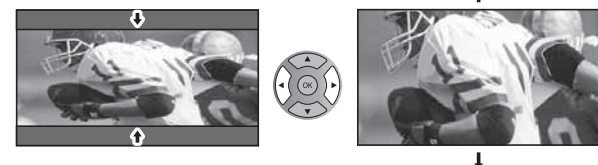

- To reset the aspect ratio →  (OK)

## Data format for SD Card browsing

Photo:	Still images recorded with digital still cameras compatible with JPEG files of DCF* and EXIF** standards
Data format:	Baseline JPEG (Sub-sampling: 4:4:4, 4:2:2 or 4:2:0)
Max. number of files:	9,999
Image resolution:	160 x 120 to 20,000,000

\* DCF (Design rule for camera file system): A Japan Electronics and Information Technology Industries Association's standard  
 \*\* EXIF (Exchangeable Image File Format)

### Caution

- A JPEG image modified with a PC may not be displayed.
- Partly degraded files might be displayed at a reduced resolution.

### Note

- Folder structure viewed in PC

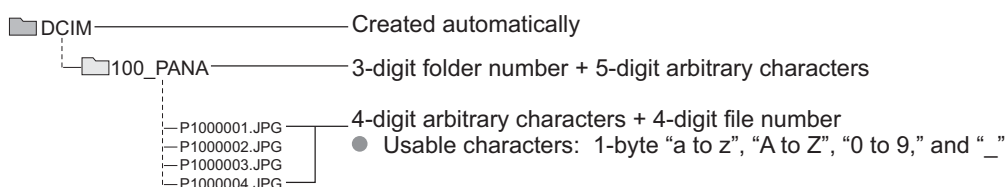

- The folder and file names may be different depending on the digital camera used.
- For the suitable SD Memory Cards, please confirm the latest information on the following website.  
<http://panasonic.jp/support/global/cs> (This site is in English only)

## Cautions in handling SD Card:

- Use an SD Card which meets SD standards. If not, it may cause the TV to malfunction.
- Do not remove the card while the unit is accessing data (this can damage card or unit).
- Do not touch the terminals on the back of the card.
- Do not subject the card to high pressure or impact.
- Insert the card in the correct direction (otherwise, card or unit may be damaged).
- Electrical interference, static electricity or erroneous operation may damage the data or card.
- Back up the recorded data at regular intervals in case of deteriorated or damaged data or erratic operation of the unit. (Panasonic is not liable for any deterioration or damage of recorded data.)

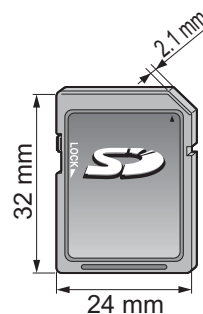

## SD Card warning messages

Message	Meaning
Please insert SD memory card into the SD slot at the side of the TV.	<ul style="list-style-type: none"> <li>● The card is not inserted.</li> </ul>
No photos	<ul style="list-style-type: none"> <li>● The card has no data or this type of data is not supported.</li> </ul>
Cannot read file	<ul style="list-style-type: none"> <li>● The file is broken or unreadable.</li> <li>● The TV does not support the format.</li> </ul>

# Technical Information (Continued)

## HDMI connection

HDMI (high-definition multimedia interface) allows you to enjoy high-definition digital images and high-quality sound by connecting the TV unit and the devices.

HDMI-compatible equipment (\*1) with an HDMI or DVI output terminal, such as a set-top box or a DVD player, can be connected to the HDMI connector using an HDMI compliant (fully wired) cable.

- HDMI is the world's first complete digital consumer AV interface complying with a non-compression standard.
- If the external equipment has only a DVI output, connect to the HDMI terminal via a DVI to HDMI adapter cable (\*2).
- When the DVI to HDMI adapter cable is used, connect the audio cable to the audio input terminal.
- Audio settings can be made on the "HDMI 1 in", "HDMI 2 in" or "HDMI 3 in" menu screen. (p. 20)  
Applicable audio signal sampling frequencies (L.PCM): 48 kHz, 44.1 kHz, 32 kHz  
(\*1): The HDMI logo is displayed on an HDMI-compliant device.  
(\*2): Enquire at your local digital equipment retailer shop.

### Caution

- Use with a PC is not assumed.
- All signals are reformatted before being displayed on the screen.
- If the connected device has an aspect adjustment function, set the aspect ratio to "16:9".
- These HDMI connectors are "type A".
- These HDMI connectors are compatible with HDCP (High-Bandwidth Digital Content Protection) copyright protection.
- A device having no digital output terminal may be connected to the input terminal of either "COMPONENT" or "VIDEO" to receive analog signals.
- The HDMI input terminal can be used with only the following image signals: 480i, 480p, 720p, 1080i, 1080p.  
Match the output setting of the digital device.
- For details of the applicable HDMI signals, see p. 33.

## DIGITAL AUDIO OUT terminals

You can enjoy your Home theater by connecting a Dolby Digital (5.1 channel) decoder and "Multi Channel" amplifier to the DIGITAL AUDIO OUT terminals.

### Caution

- Depending on your DVD player and DVD-Audio software the copyright protection function may operate and disable optical output.
- When an ATSC channel is selected, the output from the DIGITAL AUDIO OUT jack will be Dolby Digital. When an NTSC channel is selected, the output will be PCM.

## Picture mode

- Vivid: Provides enhanced picture contrast and sharpness for viewing in a well-lit room.
- Standard: Recommended for normal viewing conditions with subdued room lighting.
- Cinema: For watching movies in a darkened room. It provides a soft, film-like picture.
- Custom (Photo): Customizes each item according to your taste.  
Photo is displayed in JPEG menu.

## H size

- Aspect Ratio: 4:3

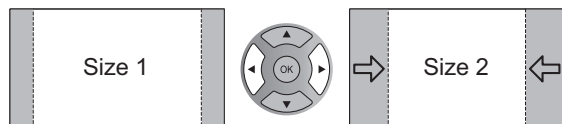

- The width will be decreased on both sides to reduce noise.

- Aspect Ratio: FULL/JUST(H-FILL/ZOOM)

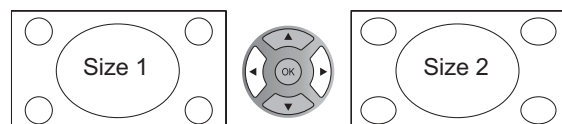

- The width will be increased on both sides to reduce noise.

See page 20 for more information



## Input signal that can be displayed

\* Mark: Applicable input signal for Component (Y, PB, PR), HDMI and PC

	horizontal frequency (kHz)	vertical frequency (Hz)	COMPONENT	HDMI	PC
525 (480) / 60i	15.73	59.94	*	*	
525 (480) /60p	31.47	59.94	*	*	
750 (720) /60p	45.00	59.94	*	*	
1,125 (1,080) /60i	33.75	59.94	*	*	
1,125 (1,080)/60p	67.43	59.94		*	
1,125 (1,080)/60p	67.50	60.00		*	
1,125(1,080)/24p	26.97	23.98		*	
1,125(1,080)/24p	27.00	24.00		*	
640 × 400 @70	31.47	70.08			*
640 × 480 @60	31.47	59.94			*
Macintosh13" (640 × 480)	35.00	66.67			*
640 × 480 @75	37.50	75.00			*
852 × 480 @60	31.44	59.89			*
800 × 600 @60	37.88	60.32			*
800 × 600 @75	46.88	75.00			*
800 × 600 @85	53.67	85.08			*
Macintosh16" (832 × 624)	49.73	74.55			*
1,024 × 768 @60	48.36	60.00			*
1,024 × 768 @70	56.48	70.07			*
1,024 × 768 @75	60.02	75.03			*
1,024 × 768 @85	68.68	85.00			*
Macintosh 21" (1,152 × 870)	68.68	75.06			*
1,280 × 768 @60	47.78	59.87			*
1,280 × 1,024 @60	63.98	60.02			*
1,366 × 768 @60	48.39	60.04			*

### Note

- Signals other than above may not be displayed properly.
- The above signals are reformatted for optimal viewing on your display.

## PC Input Terminals Connection

- Computer signals which can be input are those with a horizontal scanning frequency of 15 to 110 kHz and vertical scanning frequency of 48 to 120 Hz. (However, the image will not be displayed properly if the signals exceed 1,200 lines.)
- Some PC models cannot be connected to the set.
- There is no need to use an adapter for computers with IBM PC/AT compatible D-sub 15P terminal.
- The maximum resolution: 1,280 × 1,024  
If the display resolution exceeds these maximums, it may not be possible to show fine detail with sufficient clarity.
- Signal Names for D-sub 15P Connector

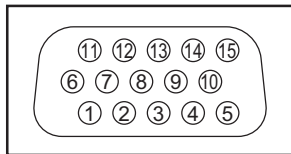

Pin Layout for PC Input Terminal

Pin No.	Signal Name	Pin No.	Signal Name	Pin No.	Signal Name
①	R	⑥	GND (Ground)	⑪	NC (not connected)
②	G	⑦	GND (Ground)	⑫	NC
③	B	⑧	GND (Ground)	⑬	HD/SYNC
④	NC (not connected)	⑨	NC (not connected)	⑭	VD
⑤	GND (Ground)	⑩	GND (Ground)	⑮	NC

# FAQ

Before requesting service or assistance, please follow these simple guides to resolve the problem.  
If the problem still persists, please contact your local Panasonic dealer or Panasonic Service Center for assistance.

## White spots or shadow images (noise)

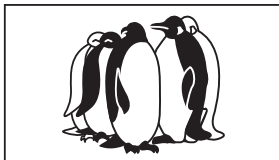

- Check the position, direction, and connection of the antenna.

## Interference or frozen digital channels (intermittent sound)



- Change the direction of antenna for digital channels.
- Check "Signal meter" (p. 25). If the signal is weak, check the antenna and consult your local dealer.

## The LCD panel moves slightly when it is pushed with a finger. A clattering sound might be heard

This is not a malfunction.

- There is some looseness around the panel to prevent damage to the panel.

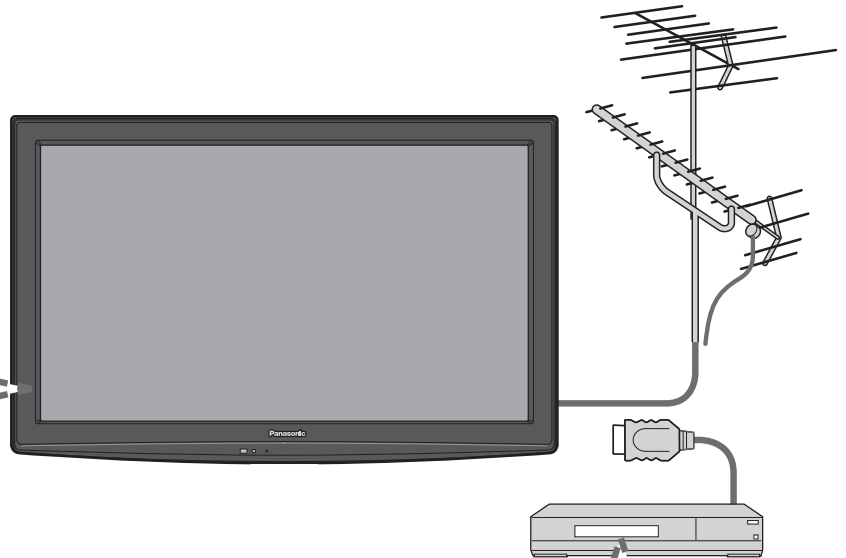

## Pictures from external equipment are distorted when the unit is connected via HDMI

- Is the HDMI cable connected properly?
- Turn Off the TV unit and equipment, then turn them On again.
- Check an input signal from the equipment. (p. 33)
- Use equipment compliant with EIA/CEA-861/861B.

## When the channel is changed on an STB that is connected with HDMI, "HDMI" may be displayed on the top left of the screen

- This is not a malfunction.

## Recording does not start immediately

- Check the settings of the recorder. For details, read the manual of the recorder.

## The remote control does not work

- Are the batteries installed correctly? (p. 7)
- Are the batteries new?



If there is a problem with your TV, please refer to the table below to determine the symptoms, then carry out the suggested check. If this does not solve the problem, please contact your local Panasonic dealer, quoting the model number and serial number (both found on the rear of the TV).

	Problem	Actions
Screen	Some spots remain bright or dark	<ul style="list-style-type: none"> <li>The LCD panel is made up of a few million pixels and is produced with advanced technology through an intricate process. Sometimes a few pixels may be bright or dark. These pixels do not indicate a defective panel and will have no impact on the performance of the TV.</li> </ul>
	Chaotic image, noisy	<ul style="list-style-type: none"> <li>Check nearby electrical products. (car or motorcycle ignition systems, fluorescent lamp, etc.)</li> </ul>
	No image is displayed on screen	<ul style="list-style-type: none"> <li>Check Picture menu (p. 20)</li> <li>Check the cable connections.</li> <li>Check that the correct input has been selected.</li> </ul>
	Only spots are displayed instead of images	<ul style="list-style-type: none"> <li>Check the channel settings. (p. 24)</li> <li>Check the antenna cables.</li> </ul>
	Neither image nor sound is produced	<ul style="list-style-type: none"> <li>Is the power cord plugged into the outlet?</li> <li>Is the TV unit turned On?</li> <li>Check Picture menu (p. 20) and volume.</li> <li>Check the AV cable connections. (p. 11-12)</li> <li>Check that the correct input has been selected. (p. 15)</li> </ul>
	Black Box appears	<ul style="list-style-type: none"> <li>Change settings of Closed caption (CC). (p. 26)</li> </ul>
Sound	No sound is produced	<ul style="list-style-type: none"> <li>Are the speakers' cables connected correctly?</li> <li>Is "Sound Mute" active? (p. 13)</li> <li>Is the volume set to the minimum?</li> <li>Is "TV speakers" set to "Off"? (p. 20)</li> <li>Change "SAP" settings. (p. 14)</li> <li>Check "HDMI 1 in", "HDMI 2 in" or "HDMI 3 in" settings. (p. 20)</li> </ul>
	Sound is unusual	<ul style="list-style-type: none"> <li>Set "SAP" setting to "Stereo" or "Mono".</li> <li>Check the HDMI device connected to the unit.</li> <li>Set the audio setting of the HDMI device to "Linear PCM".</li> <li>If digital sound connection has a problem, select analog sound connection.</li> </ul>
	Unknown sound heard 1- Sounds from TV cabinet 2- Tick/Click sound 3- Buzzing sound	<ol style="list-style-type: none"> <li>Changes in the temperature and humidity of the room may cause the TV's cabinet to expand or contract and produce metallic sounds. This is not a sign of faulty operation or a malfunction.</li> <li>When the TV is powered on, an electrical component in the TV activates producing a tick/click sound. This is not a sign of faulty operation or a malfunction.</li> <li>Electrical circuits are active while the TV set is on. This is not a sign of faulty operation or a malfunction.</li> </ol>
Other	The main unit is hot.	<ul style="list-style-type: none"> <li>The main unit radiates heat and some of the parts may become hot. This is not a problem for performance or quality. Set up in a location with good ventilation. Do not cover the ventilation holes of the TV with a tablecloth, etc., and do not place on top of other equipment.</li> </ul>

# Care and Cleaning

**First, unplug the Power cord plug from the wall outlet.**

## Display panel

The front of the display panel has been specially treated. Wipe the panel surface gently using only a cleaning cloth or a soft, lintfree cloth.

- If the surface is particularly dirty, soak a soft, lint-free cloth in diluted mild liquid dish soap (1 part mild liquid dish soap diluted by 100 times the amount of water) and then wring the cloth to remove excess liquid. Use this cloth to wipe the surface of the display panel, then wipe it evenly with a dry cloth of the same type until the surface is dry.
- Do not scratch or hit the surface of the panel with fingernails or other hard objects. Furthermore, avoid contact with volatile substances such as insect sprays, solvents, and thinner; otherwise, the quality of the surface may be adversely affected.

## Cabinet

If the cabinet becomes dirty, wipe it with a soft, dry cloth.

- If the cabinet is particularly dirty, soak the cloth in a weak mild liquid dish soap and then wring the cloth dry. Use this cloth to wipe the cabinet and then wipe it dry with a dry cloth.
- Do not allow any mild liquid dish soap to come into direct contact with the surface of the LCD TV.  
If water droplets get inside the unit, operating problems may result.
- Avoid contact with volatile substances such as insect sprays, solvents, and thinner; otherwise, the quality of the cabinet surface may be adversely affected or the coating may peel off. Furthermore, do not leave it for long periods in contact with articles made from rubber or PVC.

## Pedestal

### ● Cleaning

Wipe the surfaces with a soft, dry cloth. If the unit is particularly dirty, clean it using a cloth soaked with water to which a small amount of mild liquid dish soap has been added and then wipe with a dry cloth.

Do not use products such as solvents, thinner, or household wax for cleaning, as they can damage the surface coating. (If using a chemically-treated cloth, follow the instructions supplied with the cloth.)

- Do not attach sticky tape or labels, as they can make the surface of the pedestal dirty. Do not allow long-term contact with rubber, vinyl products, or the like. (Doing so will cause deterioration.)

## Power cord plug

Wipe the plug with a dry cloth at regular intervals. (Moisture and dust can lead to fire or electrical shock.)

# Specifications

		TH-32LRU30	TH-37LRU30	TH-42LRU30
<b>Power Source</b>		AC 110-127 V, 60 Hz		
<b>Power Consumption</b>	<b>Rated Power Consumption</b>	106 W	159 W	206 W
	<b>Standby condition</b>	0.8 W	0.8 W	0.9 W
<b>Display panel</b>	<b>Aspect Ratio</b>	16:9		
	<b>Visible screen size</b> (W × H × Diagonal)	32" class (31.5 inches measured diagonally) 27.5" × 15.4" × 31.5" (698 mm × 392 mm × 800 mm)	37" class (37.0 inches measured diagonally) 32.2" × 18.1" × 37.0" (819 mm × 460 mm × 940 mm)	42" class (42.0 inches measured diagonally) 36.6" × 20.6" × 42.0" (930 mm × 523 mm × 1,067 mm)
	<b>(No. of pixels)</b>	1,049,088 (1,366 (W) × 768 (H)) [4,098 × 768 dots]	2,073,600 (1,920 (W) × 1,080(H)) [5,760 × 1,080 dots]	
	<b>Speaker</b>	1-way 2 bottom SP System		
<b>Sound</b>	<b>Audio Output</b>	20 W [10 W + 10 W] (10 % THD)		
	<b>PC signals</b>	VGA, SVGA, XGA, WXGA, SXGA Horizontal scanning frequency 31 - 69 kHz Vertical scanning frequency 59 - 86 Hz		
<b>Channel Capability-ATSC/NTSC (Digital/Analog)</b>		VHF/ UHF: 2 - 69, CATV: 1 - 135 (support MPEG4 H.264 decode)		
<b>Operating Conditions</b>		Temperature: 32 °F – 95 °F (0 °C – 35°C) Humidity: 20 % – 80 % RH (non-condensing)		
<b>Connection Terminals</b>	<b>VIDEO IN 1-2</b>	VIDEO: RCA PIN Type × 1 1.0 V [p-p] (75 Ω) AUDIO L - R: RCA PIN Type × 2 0.5 V [rms]		
	<b>COMPONENT IN</b>	Y: 1.0 V [p-p] (including synchronization) PB, PR: ±0.35 V [p-p] AUDIO L-R: RCA PIN Type × 2 0.5 V [rms]		
	<b>HDMI 1-3</b>	TYPE A Connector × 3		
	<b>PC</b>	D-SUB 15PIN: R,G,B / 0.7 V [p-p] (75 Ω) HD, VD / 1.0 - 5.0 V [p-p] (high impedance)		
	<b>SERIAL CTRL</b>	M3 Jack × 1 (RS232C)		
	<b>DATA/MTI</b>	RJ-11C (6pin) ● Multiple Television Interface (MTI) ● Nintendo Controller Power (pin3: DC12V / 30mA (max)) ● SNES Controller		
	<b>Audio out</b>	M3 JACK × 1 0.5 V [rms] (high impedance)		
	<b>Card slot</b>	SD CARD slot × 1		
	<b>DIGITAL AUDIO OUT</b>	PCM / Dolby Digital, Fiber Optic		
<b>FEATURES</b>		3D Y/C FILTER, CLOSED CAPTION, V-Chip, Vesa compatible, Integrated Pro: Idiom		
<b>Dimensions (W × H × D)</b>	<b>Including TV stand</b>	31.5" × 21.8" × 10.8" (798 mm × 553 mm × 272 mm)	36.1" × 24.5" × 12.1" (915 mm × 622 mm × 307 mm)	40.2" × 26.9" × 12.6" (1,021 mm × 682 mm × 318 mm)
	<b>TV Set only</b>	31.5" × 20.2" × 3.3" (798 mm × 511 mm × 83 mm)	36.1" × 22.8" × 3.5" (915 mm × 577 mm × 87 mm)	40.2" × 25.1" × 4.2" (1,021 mm × 637 mm × 105 mm)
<b>Mass</b>	<b>Including TV stand</b>	27.6 lb. (12.5 kg) NET	37.3 lb. (16.9 kg) NET	47.7 lb. (21.6 kg) NET
	<b>TV Set only</b>	21.0 lb. (9.5 kg) NET	29.1 lb. (13.2 kg) NET	38.6 lb. (17.5 kg) NET

[TH-32LRU30]

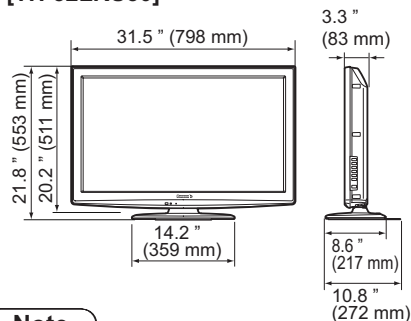

[TH-37LRU30]

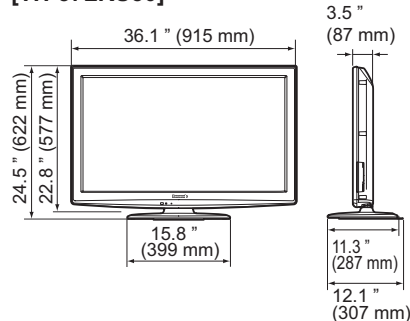

[TH-42LRU30]

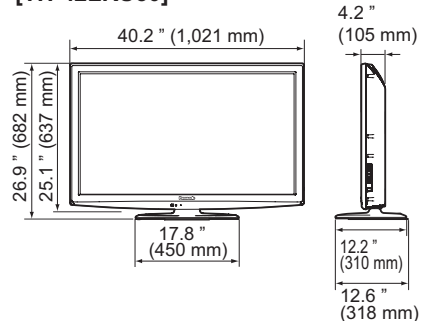

**Note**

● Design and Specifications are subject to change without notice. Mass and Dimensions shown are approximate.

Panasonic Solutions Company  
 Unit of Panasonic Corporation of  
 North America  
 Three Panasonic Way, 2F-5,  
 Secaucus, NJ 07094

**Panasonic Hospitality LCD HDTV  
 Limited Warranty**

Panasonic Solutions Company. (referred to as “the Warrantor”) will repair this product and all included accessories with new or refurbished parts, free of charge in the USA or Puerto Rico, of the original purchase in the event of a defect in materials or workmanship as follows:

<b>Models or Parts</b>	<b>Part Warranty</b>	<b>Labor Warranty</b>
Professional Flat Panel Display	2 Years	2 Years

On-site or carry-in service in the **USA and Puerto Rico** may be obtained during the warranty period by contacting Panasonic Solutions Company Service toll free at 1-800-973-4390.

This warranty is extended only to the original purchaser and is non transferable. A purchase receipt or other proof of date of original purchase will be required before warranty service is rendered.

This warranty only covers failures due to defects in materials or workmanship, which occur during normal use. The warranty does not cover damage which occur in shipment, or failures which are caused by products not supplied by the warrantor, or failures which result from improper installation, set-up adjustments, improper

antenna, inadequate signal pickup, maladjustment of consumer controls, improper operation, power line surge, improper voltage supply, lighting damage, or service by anyone other than an authorized repair facility, or damage that is attributable to acts of God.

**LIMITS AND EXCLUSIONS**

There are no express warranties except as listed above.

THE WARRANTOR SHALL NOT BE LIABLE FOR INCIDENTAL OR CONSEQUENTIAL DAMAGES (INCLUDING, WITHOUT LIMITATION, DAMAGE TO DISCS) RESULTING FROM THE USE OF THIS PRODUCT, OR ARISING OUT OF ANY BREACH OF THE WARRANTY. ALL EXPRESS AND IMPLIED WARRANTIES, INCLUDING THE WARRANTIES OF MERCHANTABILITY AND FITNESS FOR PARTICULAR PURPOSE, ARE LIMITED TO THE APPLICABLE WARRANTY PERIOD SET FORTH ABOVE.

Some states do not allow the exclusion or limitation of incidental or consequential damages, or limitations on how long an implied warranty lasts, so the above exclusions or limitations may not apply to you. This warranty gives you specific legal rights and you may have other rights, which vary from state to state.

If you have a problem with this product that is not handled to your satisfaction, then write the Consumer Affairs Department at the Company address indicated above.

In the USA and Puerto Rico  
 FOR SERVICE  
 CALL TOLL FREE  
 1-800-973-4390



USA only: This product has a fluorescent lamp that contains mercury. Disposal may be regulated in your community due to environmental considerations. For disposal or recycling information, please visit Panasonic website: <http://www.panasonic.com/environmental> or call 1-888-769-0149.

**Customer's Record**

The model number and serial number of this product can be found on its back cover. You should note this serial number in the space provided below and retain this book, plus your purchase receipt, as a permanent record of your purchase to aid in identification in the event of theft or loss, and for Warranty Service purposes.

Model Number \_\_\_\_\_

Serial Number \_\_\_\_\_

© Panasonic Corporation 2011

**Panasonic Solutions Company**  
Unit of Panasonic Corporation of North America

**Executive Office :**  
Three Panasonic Way, 2F-5, Secaucus, NJ 07094

Printed in U.S.A.  
M0411-0