

Panasonic®

Operating Instructions Basic Guide

Wireless Presentation System For business use



PressIT

Model No. **TY-WPS1**

WPS Basic Set

TY-WPSC1

WPS USB-C Basic Set

TY-WPR1

WPS Receiver

TY-WP2B1

WPS Transmitter Set

TY-WPB1

WPS Transmitter

* WPS is an abbreviation of "Wireless Presentation System".

TY-WP2BC1

WPS USB-C Transmitter Set

TY-WPBC1

WPS USB-C Transmitter

Thank you for purchasing the Panasonic product.

- Please read these instructions before operating this product and retain them for future reference.
- **Be sure to read "Safety Precautions" (page 2 to 4) before use.**
- These Operating Instructions are shared by TY-WPS1, TY-WPSC1, TY-WP2B1, TY-WPB1, TY-WP2BC1, TY-WPBC1 and TY-WPR1.

English

Safety Precautions	2
Accessories	5
Part Names	6
Connection	8
Basic Use	10
Fixing the Transmitter Connection	12
Transmitter Extension Method (Pairing)	13
Installing the Receiver	15
Notes on Using Wireless LAN	17
Request Regarding Security	19
Specifications	21

Safety Precautions

WARNING:

Stop using the product immediately when an abnormality or malfunction occurs.

Remove the power plug in the case of an abnormality.

- Smoke is emitted, or abnormal smell or sound occurs.
- Video or audio is not reproduced in some cases.
- Liquid such as water or a foreign object has entered inside the product.
- The product is deformed or damaged.

Using the product in such states may cause a fire or electric shock.

- Remove the power plug from the outlet and request repair to the dealer where you purchased the product.
- It is necessary to remove the power plug to completely turn off the power of this product.
- Do not repair the product by the customer since it is dangerous.
- Use an outlet located at a position where the hand can reach easily so that the power plug can be removed quickly.

Do not insert foreign objects into the product.

Do not insert or drop metals or flammable items into the inside the product from the vent hole, etc.

Smoke is emitted, or abnormal smell or sound occurs.

- Keep an eye on children in particular.

■ About AC adaptor

Do not use an AC adaptor or AC adaptor cable other than those supplied with this product.

Using an AC adaptor or AC adaptor cable other than those supplied may cause an electric shock or fire due to short circuit or heat generation.

Clean the power plug periodically to prevent dust from accumulating.

Failure to do so may cause a fire or electric shock due to moisture.

- Remove the power plug and wipe it with dry cloth.

Do not insert or remove the power plug with wet hand.

Doing so may cause an electric shock.

Do not use the outlet or wiring devices exceeding rated values or with currents other than 100 – 240 V AC.

Using them exceeding rated values by connecting too many plugs in one outlet may cause a fire due to heat generation.

Insert the power plug securely to the end.

Insufficient insertion may cause a fire due to an electric shock or heat generation.

- Do not use the product with a damaged plug or loose outlet.

Do not damage the AC adaptor and power plug.

(by damaging, modifying, forcibly bending, twisting, pulling or bundling them, bringing them close to heat appliances, placing heavy items on them, etc.)

Doing so may cause a fire or electric shock due to short circuit or disconnection.

- Request the dealer for repair of the AC adaptor or power plug.

Use the product 15 cm or more away from a location where a cardiac pacemaker is embedded.

Radio waves may affect the operation of the pacemaker.

Do not use the product in an airplane.

The operational safety may be impaired.

Do not use the product near an automatic door, fire alarm or other automatic control devices.

Radio waves from this product may affect automatic control devices, which may cause an operational error, resulting in an accident.

Do not use the product in hospital or a location with medical equipment.

Radio waves from this product may affect medical equipment, which may cause an operational error, resulting in an accident.

Do not use the product while touching it for a long time.

Touching the hot parts of the product and AC adaptor for a long time may cause a low-temperature burn*.

- * Persons with poor bloodstream (due to vascular impairment, poor blood circulation, diabetes or strong compression) or poor skin sensitivity (elderly persons) tend to get a low-temperature burn.

Do not touch the product and AC adaptor if it begins to thunder.

Doing so may cause an electric shock.

Do not wet the product.

Doing so may cause a fire or electric shock.

Do not place the product on unstable locations.

Placing the product on a shaky table or an inclined location may cause an injury due to falling over or dropping.

Do not remove or modify the back cover (cabinet). Keep the screws supplied with the receiver out of reach of infants.

The screws may be accidentally swallowed.

- In the event this occurs, consult a doctor immediately.

For installation, please ask a qualified technician or a dealer.

If installation is not carried out and secured correctly, it can cause falling accidents.

Do not touch the bottom surface of the transmitter during use.

The bottom surface of the transmitter may be hot during and after use for a while, resulting in a burn injury.

Also, do not place it on an object sensitive to heat. Doing so may cause deformation or discoloration.

CAUTION:

Do not block the vent hole of this product.

Do not push the product into a narrow and poorly ventilated space.

Doing so may cause heat to accumulate inside, resulting in a fire or malfunction.

Do not place a heavy item on the product.

Doing so may cause a fire or malfunction.

Do not place the product at a high-temperature location, humid or dusty location, or location subject to oil smoke or steam (such as a cooking table and humidifier).

Doing so may cause a fire or electric shock.

When removing the connection cables, be sure to hold the connector and pull it.

Pulling the cord may damage the cord, resulting in a fire due to an electric shock or short circuit.

When transferring the product, remove the connection cables of equipment beforehand.

Failure to do so may damage the cord or product, resulting in a fire or electric shock.

When not using the product for a prolonged period, remove the power plug from the outlet.

Dust may accumulate in the power plug, resulting in a fire or electric shock.

Do not pull or hang the connection cables.

Doing so may cause the product to fall over or drop, resulting in an injury.

- Keep an eye on children in particular.

■ Maintenance

For maintenance, remove the power plug from the outlet for safety.

Failure to do so may cause an electric shock.

Accessories

Check that you have the accessories and items shown.

WPS Basic Set TY-WPS1

WPS Receiver (TY-WPR1)..... 1	WPS Transmitter (TY-WPB1)..... 2	Transmitter case (TY-WPC1)..... 1
AC adaptor (DPVF3699ZA/X1)... 1 (including 4 conversion plugs)	AC adaptor cable (DPVF3515ZA/X1)... 1	HDMI cable (DPVF3512ZA/X1)... 1
USB extension cable (DPVF3513ZA/X1)... 2	Receiver mounting bracket (see page 15)..... 1	

WPS USB-C Basic Set TY-WPSC1

WPS Receiver (TY-WPR1)..... 1	WPS USB-C Transmitter (TY-WPBC1)..... 2	Transmitter case (TY-WPC1)..... 1
AC adaptor (DPVF3699ZA/X1)... 1 (including 4 conversion plugs)	AC adaptor cable (DPVF3515ZA/X1)... 1	HDMI cable (DPVF3512ZA/X1)... 1
Conversion adaptor for pairing (DPVF3516ZA/X1)... 1	Receiver mounting bracket (see page 15)..... 1	

WPS Transmitter Set TY-WP2B1

WPS Transmitter (TY-WPB1)..... 2	Transmitter case (TY-WPC1)..... 1	USB extension cable (DPVF3513ZA/X1)... 2
-------------------------------------	--------------------------------------	---

WPS Transmitter TY-WPB1

WPS Transmitter (TY-WPB1)..... 1	USB extension cable (DPVF3513ZA/X1)... 1
-------------------------------------	---

WPS USB-C Transmitter Set TY-WP2BC1

WPS USB-C Transmitter (TY-WPBC1)..... 2	Transmitter case (TY-WPC1)..... 1	Conversion adaptor for pairing (DPVF3516ZA/X1)... 1
---	--------------------------------------	---

WPS USB-C Transmitter TY-WPBC1

WPS USB-C Transmitter (TY-WPBC1)..... 1	Conversion adaptor for pairing (DPVF3516ZA/X1)... 1
---	---

WPS Receiver TY-WPR1

WPS Receiver (TY-WPR1)..... 1	AC adaptor (DPVF3699ZA/X1)... 1 (including 4 conversion plugs)	AC adaptor cable (DPVF3515ZA/X1)... 1
HDMI cable (DPVF3512ZA/X1)... 1	Receiver mounting bracket (see page 15)..... 1	

Attention

- Store small parts in an appropriate manner, and keep them away from young children.
- The part numbers of accessories are subject to change without notice.
(The actual part number may differ from the ones shown above.)
- In case you lost accessories, please purchase them from your dealer. (Available from the customer service)
- Dispose the packaging materials appropriately after taking out the items.

Part Names

Receiver (TY-WPR1)

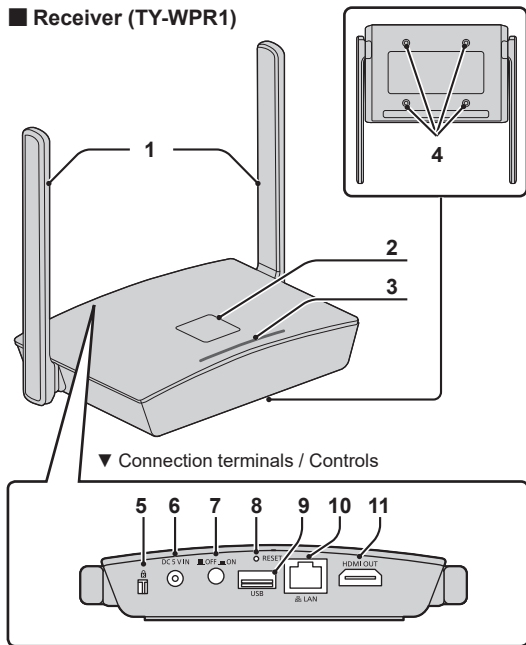

1 Antenna

2 FUNCTION button / LED

Used to save a pairing file to the USB memory.

3 Indicator

Displays the power supply status, and connection statuses of LAN and USB.

4 Screw holes for mounting bracket (page 15)

Used to attach the receiver to the mounting bracket.

▼ Connection terminals / Controls

5 Security Slot

This security slot is compatible with a Noble Wedge slot.

6 Power input terminal

7 Power button

Turns ON/OFF the power of the receiver.

8 Reset button

Restores the product to the factory default state.

9 USB terminal (Type-A)

Connects the transmitter or USB memory when pairing devices.

10 LAN terminal (RJ45)

Connects to the network to change the settings of the product.

11 HDMI output terminal

Connects an imaging device equipped with HDMI input.

■ Transmitter (TY-WPB1)

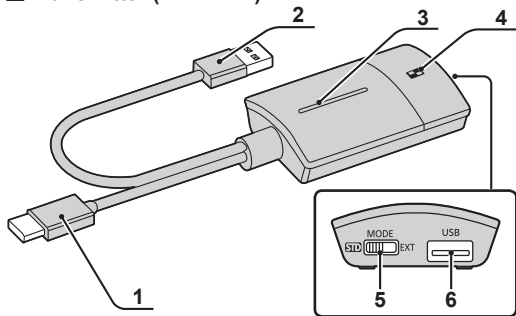

■ USB-C transmitter (TY-WPBC1)

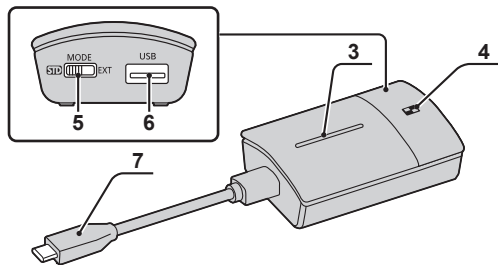

1 HDMI input terminal

Connect to an imaging device equipped with HDMI output.

2 USB terminal (Type-A)

Connect to a USB power supply device.

3 Main button / LED

Switches between on and off of image display.

4 Sub button / LED

Switches to the multi-screen mode.

5 Mode switch

It is used when pairing.

6 USB terminal (Type-A)

Connects a USB memory when pairing with the receiver.

7 USB terminal (Type-C)

Connect to an imaging device with USB Type-C output.

■ Transmitter case

2 transmitters and the USB extension cable can be stored.

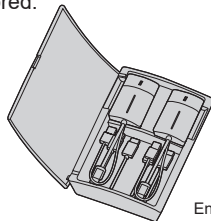

Connection

Before connection, carefully read the operation manual of the device to be connected to this system.

Turn off the power of each device before connecting cables.

Connecting the receiver

1 Connect the AC adaptor and AC adaptor cable to the receiver for power supply.

▶ Use an AC adaptor conversion plug that fits the shape of outlet.

<How to remove>

- 1 Press the button
- 2 Remove the plug

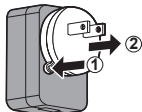

Note

- Do not remove the AC adaptor conversion plug while it is connected to the outlet.

2 Connect a display device such as a display and projector to the receiver with HDMI cable.

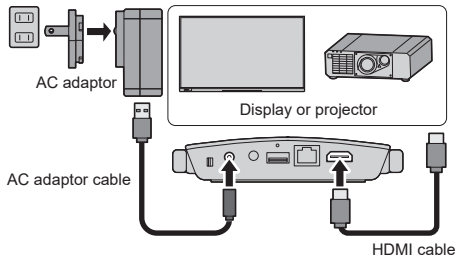

Note

- For power supply to the receiver, use the supplied AC adaptor or a USB power supply device with 5 V/2 A.

- 3 Press the power button of the receiver. When a standby screen is displayed on the display device, the receiver has completed preparation.**

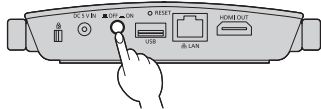

Standby screen

Connecting the transmitter

- 1 Connect the USB terminal and HDMI input terminal of the transmitter to the image output device.**

- For power supply to the transmitter, 5 V/0.9 A power supply is necessary.

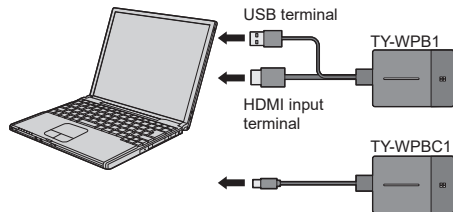

For the USB-C transmitter, connect the USB terminal (Type-C) to the image output device.

- 2 Main LED changes from red blinking (connecting) to white illumination (standby).**

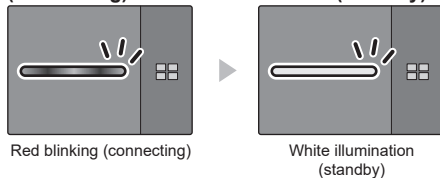

Basic Use

Single connection

This section describes how to display an image using one transmitter.

1 Press the main button of the transmitter while the standby screen is displayed.

The image is displayed.



Standby screen

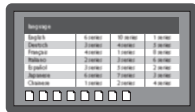

Full screen display

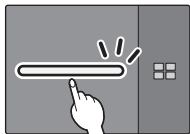

White illumination
(standby)

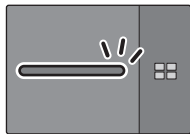

Green illumination
(display)

▶ Pressing the main button again changes the main LED to white and returns to standby state.

(The screen returns to the standby screen as well.)

- When using multiple transmitters, the image is switched to the image of the transmitter of which the main button is pressed.

Multi connection

This section describes how to display images simultaneously using multiple transmitters. Images of up to 4 transmitters can be displayed simultaneously.

1 Press and hold the sub button of the transmitter for 1 second or more during full screen display.

The sub LED changes to green illumination, and the multi-screen mode is enabled.

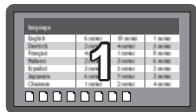

Full screen display

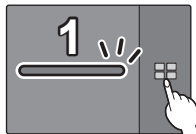

Sub LED
OFF

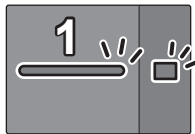

Sub LED
Green illumination
(Multi-screen mode)

2 Press the main button of the transmitter of which the image is to be added.

The image is added.

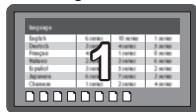

Full screen display

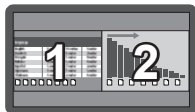

Multi-screen display

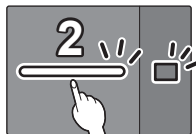

White illumination (standby)
Sub LED Green illumination

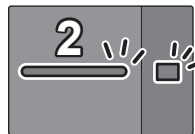

Green illumination
Sub LED Green illumination

▶ Multi-screen mode cancellation

Press and hold the sub button of the transmitter for 1 second or more.

- The sub LED changes from green illumination to OFF state, and the multi-screen mode is canceled.

Details of usage

For details of usage, read "Operating Instructions - Functional Manual".

Download the "Operating Instructions - Functional Manual" from the following URL.

<https://panasonic.net/cns/prodisplays/wps2/>

Fixing the Transmitter Connection

While multiple transmitters are paired and used, you can connect only one transmitter to the receiver and disable switching to another transmitter.

This setting prevents accidental transmitter-switching operation.

Setting the fixed mode

Press and hold the main button of the transmitter for 1 second or more while an image of one transmitter is displayed.

The main LED changes from green illumination to blue illumination, and the fixed mode is enabled.

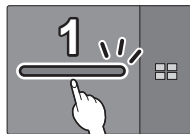
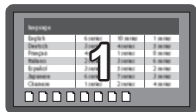
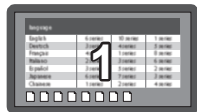

Green illumination

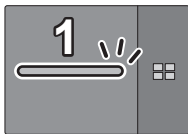

Blue illumination (fixed mode)

Other transmitters

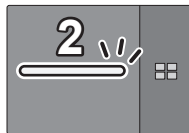

White illumination
(standby)

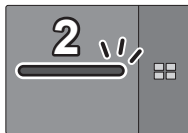

Red illumination
(operation disabled)

Canceling the fixed mode

Press and hold the main button of the transmitter for 1 second or more.

The main LED changes from blue illumination to green illumination, and the fixed mode is canceled.

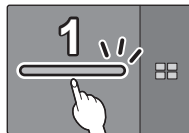

Blue illumination
(fixed mode)

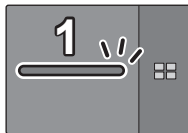

Green illumination
(fixed mode canceled)

Transmitter Extension Method (Pairing)

Pairing settings have been made for transmitter and receiver of TY-WPS1 Basic Set / TY-WPSC1 Basic Set.

Pairing by connecting the receiver and transmitter

- 1 Slide the mode switch to the STD side.

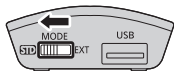

- 2 Connect the USB terminal of the transmitter to the USB terminal of the receiver.

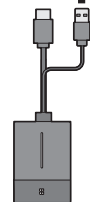

TY-WPB1



TY-WPBC1

To connect the TY-WPBC1, use the conversion adaptor for pairing supplied with the TY-WPSC1/TY-WP2BC1/TY-WPBC1.

Wait for a while until the LED of the receiver blinks in white. Then, pairing starts automatically. "Pairing..." (pairing in progress) is displayed on the standby screen.

- 3 Pairing is complete.

"Pairing OK" is displayed and the LED of the receiver lights up in white.



- 4 Remove the USB cable of the transmitter from the receiver.

Pairing by saving a file to the USB memory

Supported device

- Commercially available USB memory devices are supported. (Those with security functions are not supported.)
- USB memory devices other than those formatted in FAT16 or FAT32 cannot be used.
- Up to 32 GB of USB memory in size are supported.
- Only single partition configuration is supported.

1 Connect the USB memory to the USB terminal of the receiver.

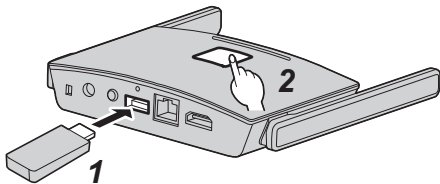

2 Press the FUNCTION button.

The LED lights up in white and the pairing file is saved to the USB memory.

3 Remove the USB memory.

4 Slide the mode switch to the EXT side.

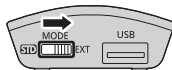

5 Supply power to the transmitter.

TY-WPB1



TY-WPBC1



5 V/0.9 A
Power supply

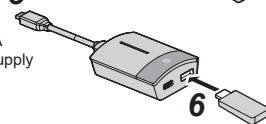

6 Connect the USB memory to the USB terminal of the transmitter.

7 Pairing is complete.

The main LED of the transmitter lights up in white.

8 Remove the USB memory from the transmitter.

Installing the Receiver

Components for receiver mounting bracket

Check the following parts are included.

Base bracket (A-1)1
(DPVF3503ZA/X1)

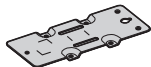

Sheet A (B-1)1
(DPVF3507ZA/X1)
(30 × 12 mm)



Connecting bracket A (A-2) ...1
(DPVF3505ZA/X1)
Used to install on the display.



Sheet B (B-2)3
(DPVF3508ZA/X1)
(24 × 20 mm)



Connecting bracket B (A-3) ...1
(DPVF3504ZA/X1)
Used to install on the display.



Knurled screw (C-1)2
(DPVF3509ZA/X1)
(M4 × 5)



Connecting bracket C (A-4) ...1
(DPVF3506ZA/X1)
Used to install on the projector.



Screw (C-2)6
(DPVF3510ZA/X1)
(M4 × 5)



Screw (C-3)2
(DPVF3511ZA/X1)
(M3 × 8)



Installing on the ceiling or wall

1 Place the base bracket (A-1) aligning it with the 4 screw holes on the bottom surface of the receiver.

2 Fix the base bracket (A-1) with 4 screws (C-2).

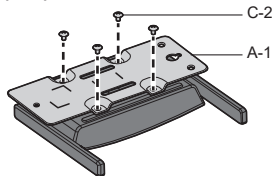

The base bracket can be mounted in either vertical or horizontal direction.

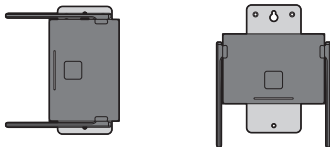

3 Fix the receiver to the ceiling or wall with 2 screws.

Use screws (commercially available) of the appropriate type and length according to the ceiling or wall to be installed. (Recommended size: M4)

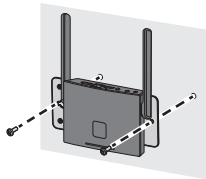

Other installation method

The receiver can be installed on the display or projector.

● Installing on the display

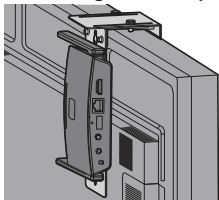

● Installing on the projector

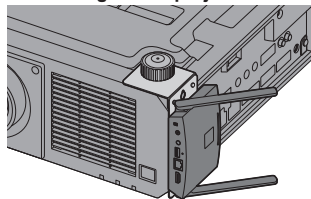

For details of installation method, read "Operating Instructions - Functional Manual".

Download the "Operating Instructions - Functional Manual" from the following URL.

<https://panasonic.net/cns/prodisplays/wps2/>

Notes on Using Wireless LAN

Wireless LAN uses radio waves in the 5 GHz bands.
Be sure to read and fully understand the following items before use.

Use this product indoors.

- Using the 5 GHz-band wireless device outdoors is prohibited by the Radio Act.

If at all possible, avoid the use of cellular phones, TV sets or radios near the product.

- Cellular phones, TV sets, radios and similar devices use different radio bands from the product, so there is no effect on wireless communication or the transmission and reception of these devices. However, radio waves from the product may produce audio or video noise.

Wireless communication radio waves cannot penetrate steel reinforcements, metal, concrete, etc.

- Communication is possible through walls and floors made from materials such as wood and glass (except glass containing wire mesh), but not through walls and floors made from steel reinforcements, metal, concrete, etc.

The product may not work properly due to strong radio wave from the broadcast station or the radio.

- If there is any facility or equipment, which outputs strong radio wave, near the installation location, set up the product at a location sufficiently far from the source of the radio wave.

Using the product outside the country

- It is forbidden to take the product outside the country or region where you purchased it, so use it only in the said country or region. Also, note that depending on countries or regions there are restrictions on the channels and frequencies at which you can use the wireless LAN.

Declaration of Conformity (DoC)

"Hereby, Panasonic Connect Co., Ltd. declares that this product is in compliance with the essential requirements and other relevant provisions of the Directive 2014/53/EU."

If you want to get a copy of the original DoC of this product, please visit the following website:

<http://www.ptc.panasonic.de>

Authorized Representative:

Panasonic Testing Centre

Panasonic Service Europe, a division of Panasonic Connect Europe GmbH

Winsbergring 15, 22525 Hamburg, Germany

Indoor use restrictions are to be followed for the following countries if using 5 GHz frequency band.

Austria, Belgium, Bulgaria, Croatia, Cyprus, Czech Republic, Denmark, Estonia, Finland, France, Germany, Greece, Hungary, Iceland, Ireland, Italy, Latvia, Liechtenstein, Lithuania, Luxembourg, Malta, Netherlands, Norway, Poland, Portugal, Romania, Slovakia, Slovenia, Spain, Sweden, Switzerland, Turkey, United Kingdom

WLAN: Maximum Power

23 dBm (5.180 GHz - 5.240 GHz)

Directive: 2014/53/EU

Request Regarding Security

When using this product, take safety measures against the following incidents.

- Personal information being leaked via this product
- Unauthorized operation of this product by a malicious third party
- Interfering or stopping of this product by a malicious third party

Take sufficient security measures.

Precautions on security when using wireless LAN products

- The advantage of a wireless LAN is that information can be exchanged between a PC or other such equipment and an access point using radio waves as long as you are within range for radio transmissions. On the other hand, because the radio waves can travel through obstacles (such as walls) and are available everywhere within a given range, problems of the type listed below may occur if security-related settings are not made.
 - A malicious third-party may intentionally intercept and monitor transmitted data including the content of e-mail and personal information such as your ID, password, and/or credit card numbers.

- A malicious third-party may access your personal or corporate network without authorization and engage in the following types of behaviour.

Retrieve personal and/or secret information (information leak)

Spread false information by impersonating a particular person (spoofing)

Overwrite intercepted communications and issue false data (tampering)

Spread harmful software such as a computer virus and crash your data and/or system (system crash)

- Since most wireless LAN adaptors or access points are equipped with security features to take care of these problems, you can reduce the possibility of these problems occurring when using this product by making the appropriate security settings for the wireless LAN device.
- Some wireless LAN devices may not be set for security immediately after purchase. To decrease the possibility of occurrence of security problems, before using any wireless LAN devices, be absolutely sure to make all security-related settings according to the instructions given in the operation manuals supplied with them.

Depending on the specifications of the wireless LAN, a malicious third-party may be able to break security settings by special means.

If you cannot perform security settings for your wireless LAN by yourself, please contact the Panasonic dealer.

- Panasonic Connect Co., Ltd. asks customers to thoroughly understand the risk of using this product without making security settings, and recommends that the customer make security settings at their own discretion and responsibility.

Specifications

Receiver

Model No.	TY-WPR1
Product name	WPS Receiver
Video output	HDMI × 1 (HDCP1.4)
Output resolution	1920 x 1080/60p, 3840 x 2160/30p (max.)
Number of simultaneous connections	32
Wireless communication standard	IEEE802.11a/n/ac Bluetooth (GFSK, π/4-DQPSK, 8DPSK)
Data rate wireless	867 Mbps (max.)
Frequency band	5 GHz (5.150 GHz to 5.250 GHz)
Security	WPA/WPA2/WPA3 (WPA3-Enterprise is not supported)
Reachable distance	Up to 30 m (Locations with good visibility and radio wave conditions)
FUNCTION LED	
White blinking	Pairing in progress
White illumination	Pairing complete
LAN terminal	RJ45 × 1 10BASE-T/100BASE-TX/ 1000BASE-T supported
USB terminal	USB connector × 1, Type-A
Power supply	DC 5 V/2 A
Dimensions (W × H × D)	120 mm × 26 mm × 81 mm / 4.71" × 1.03" × 3.19" (excluding antennas)
Mass	Approx. 181 g / 0.4 lbs
Operating condition	Temperature: 0 °C to 35 °C (32 °F to 95 °F) Humidity: 20 % to 80 % (no condensation)
Storage condition	Temperature: -20 °C to 60 °C (-4 °F to 140 °F) Humidity: 20 % to 80 % (no condensation)

Transmitter

Model No.	TY-WPB1	TY-WPBC1
Product name	WPS Transmitter	WPS USB-C Transmitter
Video input	HDMI × 1 (HDCP1.4)	USB Type-C × 1 (HDCP1.4, DisplayPort Alt Mode)
Input resolution	1920 x 1080/60p (max.)	
Wireless communication standard	IEEE802.11a/n/ac	
Data rate wireless	433 Mbps (max.)	
Frequency band	5 GHz (5.150 GHz to 5.250 GHz)	
Security	WPA/WPA2/WPA3 (WPA3-Enterprise is not supported)	
Reachable distance	Up to 30 m (Locations with good visibility and radio wave conditions)	
Main LED		
White blinking	Standby (no signal input), pairing in progress	
White illumination	Standby or pairing complete	
Red blinking	Connecting	
Red illumination	Operation disabled	
Green blinking	Image being displayed (no signal input)	
Green illumination	Image being displayed	
Blue blinking	Fixed mode (no signal input)	
Blue illumination	Fixed mode	
Sub LED		
Green illumination	Multi-screen mode	
USB terminal	USB connector × 1, Type-A	
Power supply	DC 5 V/0.9 A	
Dimensions (W × H × D)	51 mm × 21 mm × 73 mm / 2.00" × 0.80" × 2.86" (excluding cables)	51 mm × 26 mm × 73 mm / 2.00" × 1.00" × 2.86" (excluding cables)
	51 mm × 21 mm × 283 mm / 2.00" × 0.80" × 11.12" (including cables)	51 mm × 26 mm × 178 mm / 2.00" × 1.00" × 6.98" (including cables)
Mass	Approx. 110 g / 0.3 lbs	Approx. 110 g / 0.3 lbs
Operating condition	Temperature: 0 °C to 35 °C (32 °F to 95 °F) Humidity: 20 % to 80 % (no condensation)	
Storage condition	Temperature: -20 °C to 60 °C (-4 °F to 140 °F) Humidity: 20 % to 80 % (no condensation)	

Software License

This product incorporates the following software:

- (1) the software developed independently by or for Panasonic Connect Co., Ltd.,
- (2) the software owned by third party and licensed to Panasonic Connect Co., Ltd.,
- (3) the software licensed under the GNU General Public License, Version 2.0 (GPL V2.0),
- (4) the software licensed under the GNU LIBRARY General Public License, Version 2.0 (LGPL V2.0),
- (5) the software licensed under the GNU LESSER General Public License, Version 2.1 (LGPL V2.1), and/or
- (6) open source software other than the software licensed under the GPL V2.0, LGPL V2.0 and/or LGPL V2.1.

The software categorized as (3) - (6) are distributed in the hope that it will be useful, but WITHOUT ANY WARRANTY, without even the implied warranty of MERCHANTABILITY or FITNESS FOR A PARTICULAR PURPOSE. For details, see the license conditions displayed by selecting [Software licenses], following the specified operation from the Web setting screen of this product.

At least three (3) years from delivery of this product, Panasonic Connect Co., Ltd. will give to any third party who contacts us at the contact information provided below, for a charge no more than our cost of physically performing source code distribution, a complete machine-readable copy of the corresponding source code covered under GPL V2.0, LGPL V2.0, LGPL V2.1 or the other licenses with the obligation to do so, as well as the respective copyright notice thereof.

Contact Information:

oss-cd-request@gg.jp.panasonic.com

FCC STATEMENT

This equipment has been tested and found to comply with the limits for a Class B digital device, pursuant to Part 15 of the FCC Rules. These limits are designed to provide reasonable protection against harmful interference in a residential installation. This equipment generates, uses and can radiate radio frequency energy and, if not installed and used in accordance with the instructions, may cause harmful interference to radio communications.

However, there is no guarantee that interference will not occur in a particular installation. If this equipment does cause harmful interference to radio or television reception, which can be determined by turning the equipment off and on, the user is encouraged to try to correct the interference by one or more of the following measures:

- Reorient or relocate the receiving antenna.
- Increase the separation between the equipment and receiver.
- Connect the equipment into an outlet on a circuit different from that to which the receiver is connected.
- Consult the dealer or an experienced technician for help.

FCC CAUTION:

To assure continued compliance, follow the attached installation instructions and use only the provided power supply cord. Any changes or modifications not expressly approved by Panasonic Corp. of North America could void the user's authority to operate this device.

FCC RF Exposure Warning:

- **This transmitter complies with FCC radiation exposure limits set forth for an uncontrolled environment for mobile use with minimum 8 inches (20 cm) spacing requirement between transmitter and all person's body (excluding extremities of hands, wrist and feet) during wireless modes of operation.**

<Only for wireless LAN if capable of transmission in the 5.18 ~ 5.24 GHz frequency band>

This product is restricted to indoor use due to its operation in the 5.18 to 5.24 GHz frequency range.

Supplier's Declaration of Conformity

Model No.

TY-WPR1, TY-WPB1, TY-WPBC1

Responsible Party:

Panasonic Corporation of North America
Two Riverfront Plaza, Newark, New Jersey
07102-5490

Contact Source:

Panasonic Connect North America
1-877-655-2357

General Contact:

<http://shop.panasonic.com/support>

This device complies with Part 15 of the FCC Rules.

Operation is subject to the following two conditions: (1)

This device may not cause harmful interference, and

(2) this device must accept any interference received, including interference that may cause undesired operation.

Panasonic Connect North America
Division of Panasonic Corporation of North America
Two Riverfront Plaza
Newark, NJ 07102

**PANASONIC PROFESSIONAL DISPLAY
WIRELESS PRESENTATION SYSTEMS
Limited Warranty**

Models or Parts	Part Warranty	Labor Warranty
TY-WPS1, TY-SB01WP, TY-WP2B1, TY-WPB1, TY-WPSC1, TY-WP2BC1, TY-WPBC1	3 Years	3 Years
Exceptions		
All Panasonic accessories: e.g. power adapter, batteries, etc.	1 Year	1 Year

Panasonic Connect North America (referred to as “the Panasonic”) will repair the Professional Display product (the “Product”) and its accessories as defined in the attached table, with new or refurbished parts, free of charge in the continental USA, during the applicable warranty coverage period from the original date of purchase in the event of a defect in materials or workmanship as follows: advanced replacement with a refurbished product with like conditions within the **continental USA** may be obtained during the warranty period by contacting Panasonic’s Technical Support Center at the following toll free number **855-772-8324** or via e-mail; ProDisplaySupport@us.panasonic.com. Panasonic will pay for the all transportation of

the exchange Product to the customer. For out of warranty Product units submitted for repairs or for in warranty units submitted by customers outside of the continental USA, shipping arrangements and cost (both ways) are the customer’s responsibility. Panasonic will also not be responsible for any costs associated with determining the source of system problems or for removing and installing the faulty Product.

This warranty is extended only to the original purchaser and is nontransferable. A purchase receipt or other proof of date of original purchase will be required before warranty service is rendered. Whenever the date of original purchase cannot be satisfactorily determined, the date of manufacture of the unit will be deemed to be the effective date of the warranty. Panasonic reserves the right to audit and reject any warranty claim that cannot be substantiated. This warranty only covers failures due to defects in materials or workmanship which occur during normal use of the Product.

The warranty **DOES NOT** cover damage to the display and its components which occur in shipping; failures which are caused by products not supplied by Panasonic; failures which result from accident, misuse, abuse, neglect, mishandling, misapplication, alteration, modification, faulty installation, setup adjustments, improper antenna, inadequate signal pickup, maladjustment of user controls, improper operation, power line surge, improper voltage supply, lightning damage, smoke or chemical vapors contamination, air conditioning, humidity control or other environmental conditions; failure to maintain the product in accordance with the applicable Operating Instructions; service by anyone other than an authorized repair facility; damage that is attributable to acts of violence, war, acts of God or force majeure.

The warranty does not cover units of which the model and serial number label has been defaced, modified, tampered with or removed. The warranty does not cover consumable parts.

LIMITS AND EXCLUSIONS

PANASONIC SHALL NOT BE LIABLE FOR ANY INDIRECT, INCIDENTAL, CONSEQUENTIAL, PUNITIVE OR SPECIAL DAMAGES, INCLUDING, BUT NOT LIMITED TO, LOSS OF DATA, LOSS OF PROFIT, LOSS OF REVENUE, OR LOSS OF BUSINESS OR GOODWILL, SUFFERED BY ANY PERSON, AND RESULTING FROM THE USE OF THIS PANASONIC PROFESSIONAL DISPLAY PRODUCT, OR ARISING OUT OF ANY BREACH OF THIS WARRANTY. ALL EXPRESS WARRANTIES SPECIFIED ABOVE ARE IN LIEU OF ALL OTHER WARRANTIES, EXPRESS, IMPLIED OR STATUTORY, INCLUDING BUT NOT LIMITED TO, THE IMPLIED WARRANTIES OF MERCHANTABILITY AND FITNESS FOR A PARTICULAR PURPOSE

Some states do not allow the exclusion or limitation of incidental or consequential damages, or limitations on how long an implied warranty lasts, so the above limitations or exclusions may not apply to you.

If you have a problem with this product that is not handled to your satisfaction, then write the Consumer Affairs Department at the Panasonic's address indicated above.

Trademark Credits

- HDMI, High-Definition Multimedia Interface and the HDMI Logo are trademarks or registered trademarks of HDMI Licensing Administrator, Inc. in the United States and other countries.
- USB Type-C and USB-C are trademarks or registered trademarks of USB Implementers Forum.
- PressIT is a trademark of Panasonic Holdings Corporation.

Even if no special notation has been made of company or product trademarks, these trademarks have been fully respected.

Disposal of Old Equipment Only for European Union and countries with recycling systems



This symbol on the products, packaging, and/or accompanying documents mean that used electrical and electronic products must not be mixed with general household waste.

For proper treatment, recovery and recycling of old products, please take them to applicable collection points in accordance with your national legislation.

By disposing of them correctly, you will help to save valuable resources and prevent any potential negative effects on human health and the environment.

For more information about collection and recycling, please contact your local authority.

Penalties may be applicable for incorrect disposal of this waste, in accordance with national legislation.

Notice (U.S.A. only)

Disposal may be regulated in your community due to environmental considerations. For disposal or recycling information, please visit Panasonic website:

<https://holdings.panasonic/global/corporate/sustainability.html>

or call 1-888-769-0149.

Customer's Record

The model number and serial number of this product may be found on its rear panel. You should note this serial number in the space provided below and retain this book, plus your purchase receipt, as a permanent record of your purchase to aid in identification in the event of theft or loss, and for Warranty Service purposes.

Model Number

Serial Number

Panasonic Connect North America

Unit of Panasonic Corporation of North America

Executive Office :

Two Riverfront Plaza, Newark, New Jersey 07102

Manufactured by:

Panasonic Connect Co., Ltd.

4-1-62 Minoshima, Hakata-ku, Fukuoka 812-8531, Japan

Importer:

Panasonic Connect Europe GmbH

Hagenauer Strasse 43, 65203 Wiesbaden, Germany

Authorized Representative in EU:

Panasonic Connect Europe GmbH

Panasonic Testing Centre

Winsbergring 15, 22525 Hamburg, Germany

Importer for UK:

Panasonic Connect UK,

a branch of Panasonic Connect Europe GmbH,

Maxis 2, Western Road, Bracknell, Berkshire, RG12 1RT

Panasonic Connect Co., Ltd.

4-1-62 Minoshima, Hakata-ku, Fukuoka 812-8531, Japan

Web Site: <https://panasonic.net/cns/prodisplays/>

© Panasonic Connect Co., Ltd. 2022

English

Printed in China