

Panasonic[®]

Model No.
TH-55LFV5W

Operating Instructions FULL HD LCD Display

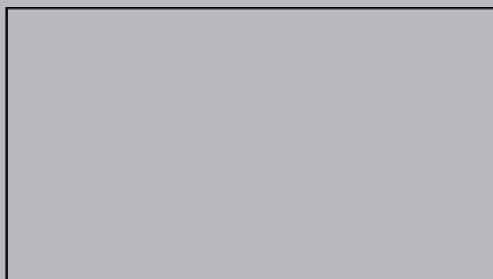

English

Please read these instructions before operating your set and retain them for future reference.

HDMI

Dear Panasonic Customer

Welcome to the Panasonic family of customers. We hope that you will have many years of enjoyment from your new LCD Display.

To obtain maximum benefit from your set, please read these Instructions before making any adjustments, and retain them for future reference.

Retain your purchase receipt as well, and record the model number and serial number of your set in the space provided on the rear cover of these instructions.

Visit our Panasonic Web Site <http://panasonic.net>

Table of Contents

Important Safety Notice	3	Using Network Function	19
Safety Precautions	4	Network Connection	19
Accessories	7	OSD Menu Setup for Network Connection.....	20
Accessories Supplied	7	Using Web Browser Control	21
VESA Mounting	8	Before Using Web Browser Control	21
Cautions when installing or moving	8	Access from Web Browser	22
Parts and Functions	9	On-Screen Display Menu	23
Control Panel.....	9	Entering the OSD Menu	23
Input/Output Terminals	10	OSD Menu Overview.....	23
Connections	11	Input Mode	30
AC Cord Connection	11	Cleaning and Troubleshooting	31
Cable Securing.....	11	Cleaning	31
DVD/VCR/VCD Connection	12	Troubleshooting.....	32
PC Connection	14	Technical Specifications	34
External Audio Connection	16		
SERIAL Terminals Connection	17		
Daisy-chain Connection	18		

Trademark Credits

- VGA is a trademark of International Business Machines Corporation.
- Macintosh is a registered trademark of Apple Inc., USA.
- SVGA, XGA, SXGA and UXGA are registered trademarks of the Video Electronics Standard Association.
- Even if no special notation has been made of company or product trademarks, these trademarks have been fully respected.
- HDMI, the HDMI Logo, and High-Definition Multimedia Interface are trademarks or registered trademarks of HDMI Licensing LLC in the United States and other countries.

NOTE:

Image retention may occur. If you display a still picture for an extended period, the image might remain on the screen. However, it will disappear after a while.

Important Safety Notice

WARNING

1. To prevent damage which may result in fire or shock hazard, do not expose this appliance to dripping or splashing.
Do not place containers with water (flower vase, cups, cosmetics, etc.) above the set. (including on shelves above, etc.)
No naked flame sources, such as lighted candles, should be placed on / above the set.
2. To prevent electric shock, do not remove cover. No user serviceable parts inside. Refer servicing to qualified service personnel.
3. Do not remove the earthing pin on the power plug. This apparatus is equipped with a three pin earthing-type power plug. This plug will only fit an earthing-type power outlet. This is a safety feature. If you are unable to insert the plug into the outlet, contact an electrician.
Do not defeat the purpose of the earthing plug.
4. To prevent electric shock, ensure the earthing pin on the AC cord power plug is securely connected.

CAUTION

- This appliance is intended for use in environments which are relatively free of electromagnetic fields.
- Using this appliance near sources of strong electromagnetic fields or where electrical noise may overlap with the input signals could cause the picture and sound to wobble or cause interference such as noise to appear.
- To avoid the possibility of harm to this appliance, keep it away from sources of strong electromagnetic fields.

IMPORTANT: THE MOULDED PLUG

FOR YOUR SAFETY, PLEASE READ THE FOLLOWING TEXT CAREFULLY.

This display is supplied with a moulded three pin mains plug for your safety and convenience. A 10 amp fuse is fitted in this plug. Shall the fuse need to be replaced, please ensure that the replacement fuse has a rating of 10 amps and that it is approved by ASTA or BSI to BS1362.

Check for the ASTA mark  or the BSI mark  on the body of the fuse.

If the plug contains a removable fuse cover, you must ensure that it is refitted when the fuse is replaced. If you lose the fuse cover the plug must not be used until a replacement cover is obtained. A replacement fuse cover can be purchased from your local Panasonic dealer.

Do not cut off the mains plug.

Do not use any other type of mains lead except the one supplied with this display.

The supplied mains lead and moulded plug are designed to be used with this display to avoid interference and for your safety.

If the socket outlet in your home is not suitable, get it changed by a qualified electrician.

If the plug or mains lead becomes damaged, purchase a replacement from an authorized dealer.

WARNING : — THIS DISPLAY MUST BE EARTHED.

How to replace the fuse. Open the fuse compartment with a screwdriver and replace the fuse.

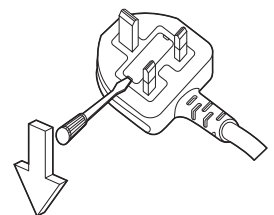

Safety Precautions

WARNING

■ Setup

This LCD Display is for use only with the following optional accessories. Use with any other type of optional accessories may cause instability which could result in the possibility of injury.

(All of the following accessories are manufactured by Panasonic Corporation.)

- Remote Control Kit..... TY-RM50VW
- Cover-frame Kit..... TY-CF55VW50

Always be sure to ask a qualified technician to carry out set-up.

Small parts can present choking hazard if accidentally swallowed. Keep small parts away from young children. Discard unneeded small parts and other objects, including packaging materials and plastic bags/sheets to prevent them from being played with by young children, creating the potential risk of suffocation.

Do not place the Display on sloped or unstable surfaces, and ensure that the Display does not hang over the edge of the base.

- The Display may fall off or tip over.

Do not place any objects on top of the Display.

- If water is spilled onto the Display or foreign objects get inside it, a short-circuit may occur which could result in fire or electric shock. If any foreign objects get inside the Display, please consult your local Panasonic dealer.

Transport only in upright position!

- Transporting the unit with its display panel facing upright or downward may cause damage to the internal circuitry.

Ventilation should not be impeded by covering the ventilation openings with items such as newspapers, table cloths and curtains.

For sufficient ventilation;

- Leave a space of 3-15/16" (10 cm) or more at the top, bottom, left, and right to the outermost circumference of this Display.
- Leave a space of 1-31/32" (5 cm) or more at the rear.

Cautions for Wall Installation

- Wall installation should be performed by an installation professional. Installing the Display incorrectly may lead to an accident that results in death or serious injury. Furthermore, when installing on a wall, a wall hanging bracket that conforms to VESA standards (VESA 400 × 400) must be used.

■ When using the LCD Display

The Display is designed to operate on 220 - 240 V AC, 50/60 Hz. TAIWAN: 110V AC, 60Hz (for Taiwan only).

Do not cover the ventilation holes.

- Doing so may cause the Display to overheat, which can cause fire or damage to the Display.

Do not stick any foreign objects into the Display.

- Do not insert any metal or flammable objects into the ventilations holes or drop them onto the Display, as doing so can cause fire or electric shock.

Do not remove the cover or modify it in any way.

- High voltages which can cause severe electric shocks are present inside the Display. For any inspection, adjustment and repair work, please contact your local Panasonic dealer.

Ensure that the mains plug is easily accessible.

An apparatus with CLASS I construction shall be connected to a mains socket outlet with a protective earthing connection.

Do not use any power supply cord other than that provided with this unit.

- Doing so may cause fire or electric shocks.

Securely insert the power supply plug as far as it will go.

- If the plug is not fully inserted, heat may be generated which could cause fire. If the plug is damaged or the wall socket is loose, they shall not be used.

Do not handle the power supply plug with wet hands.

- Doing so may cause electric shocks.

Do not do anything that may damage the power cable. When disconnecting the power cable, pull on the plug body, not the cable.

- Do not damage the cable, make any modifications to it, place heavy objects on top of it, heat it, place it near any hot objects, twist it, bend it excessively or pull it. To do so may cause fire and electric shock. If the power cable is damaged, have it repaired at your local Panasonic dealer.

If the Display is not going to be used for any prolonged length of time, unplug the power supply plug from the wall outlet.

To prevent the spread of fire, keep candles or other open flames away from this product at all times.



■ If problems occur during use

If a problem occurs (such as no picture or no sound), or if smoke or an abnormal odour starts to come out from the Display, immediately unplug the power supply plug from the wall outlet.

- If you continue to use the Display in this condition, fire or electric shock could result. After checking that the smoke has stopped, contact your local Panasonic dealer so that the necessary repairs can be made. Repairing the Display yourself is extremely dangerous, and shall never be done.

If water or foreign objects get inside the Display, if the Display is dropped, or if the cabinet becomes damages, disconnect the power supply plug immediately.

- A short circuit may occur, which could cause fire. Contact your local Panasonic dealer for any repairs that need to be made.

Safety Precautions



CAUTION

■ When using the LCD Display

Do not bring your hands, face or objects close to the ventilation holes of the Display.

- Heated air comes out from the ventilation holes at the top of Display will be hot. Do not bring your hands or face, or objects which cannot withstand heat, close to this port, otherwise burns or deformation could result.

Be sure to disconnect all cables before moving the Display.

- If the Display is moved while some of the cables are still connected, the cables may become damaged, and fire or electric shock could result.

Disconnect the power supply plug from the wall socket as a safety precaution before carrying out any cleaning.

- Electric shocks can result if this is not done.

Clean the power cable regularly to prevent it becoming dusty.

- If dust built up on the power cord plug, the resultant humidity can damage the insulation, which could result in fire. Pull the power cord plug out from the wall outlet and wipe the mains lead with a dry cloth.

Do not burn or breakup batteries.

- Batteries must not be exposed to excessive heat such as sunshine, fire or the like.

Cleaning and maintenance

The front of the display panel has been specially treated. Wipe the panel surface gently using only a cleaning cloth or a soft, lint-free cloth.

- If the surface is particularly dirty, wipe with a soft, lint-free cloth which has been soaked in pure water or water in which neutral detergent has been diluted 100 times, and then wipe it evenly with a dry cloth of the same type until the surface is dry.
- Do not scratch or hit the surface of the panel with fingernails or other hard objects, otherwise the surface may become damaged. Furthermore, avoid contact with volatile substances such as insect sprays, solvents and thinner, otherwise the quality of the surface may be adversely affected.

If the cabinet becomes dirty, wipe it with a soft, dry cloth.

- If the cabinet is particularly dirty, soak the cloth in water to which a small amount of neutral detergent has been added and then wring the cloth dry. Use this cloth to wipe the cabinet, and then wipe it dry with a dry cloth.
- Do not allow any detergent to come into direct contact with the surface of the Display. If water droplets get inside the unit, operating problems may result.
- Avoid contact with volatile substances such as insect sprays, solvents and thinner, otherwise the quality of the cabinet surface may be adversely affected or the coating may peel off. Furthermore, do not leave it for long periods in contact with articles made from rubber or PVC.

Usage of a chemical cloth

- Do not use a chemical cloth for the panel surface.
- Follow the instructions for the chemical cloth to use it for the cabinet.

Accessories

Accessories Supplied

Check that you have the Accessories and items shown

Operation instruction book

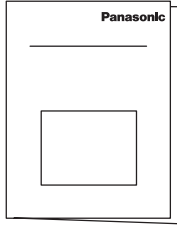

CD-ROM (Operation instruction)

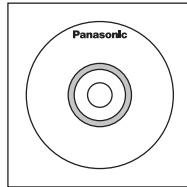

Wire claspers

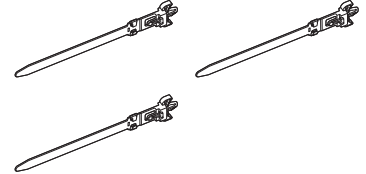

AC Power Cord

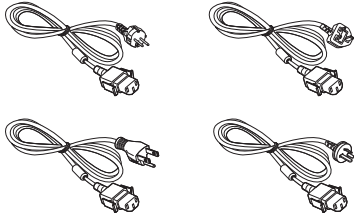

DVI cable

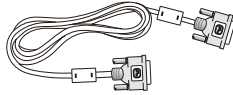

Connector cable of remote control

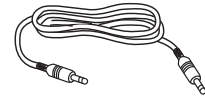

NOTE:

- The remote control is not supplied.

VESA Mounting

To mount this Display to a wall, you will have to obtain a standard wall-mounting kit (commercially available).

1. Lay a protective sheet on a table, which was wrapped around this Display when it was packaged, beneath the screen surface so as not to scratch the screen face.
2. Ensure you have all accessories for mounting this Display (wall mount, ceiling mount, etc).
3. Follow the instructions that came with the wall mounting kit. Failing to follow the correct mounting procedures could result in damage to the equipment, or injury to the user or install personnel. The product warranty does not cover the damage caused by improper installation.
4. For the wall-mounting kit, use M6 mounting screws (having a length 10 mm longer than the thickness of the mounting bracket) and tighten them securely.

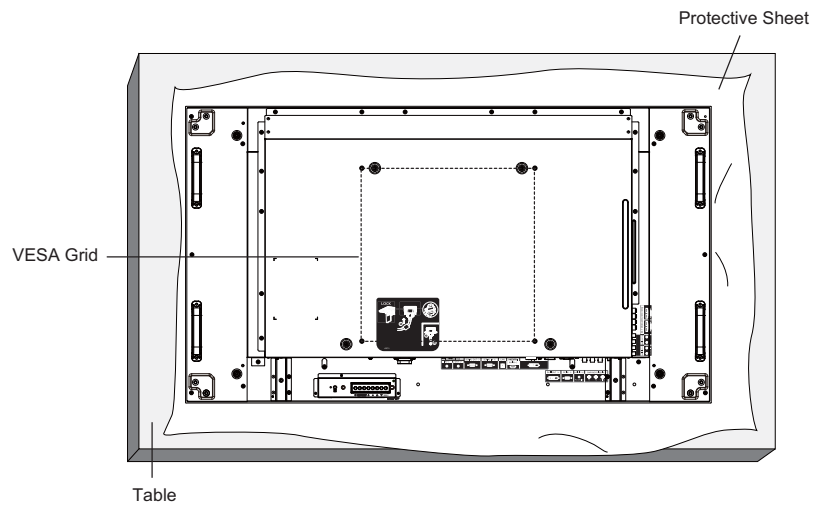

Cautions when installing or moving

To prevent this Display from falling:

- Grab the handles when moving this Display.
- Do not touch any parts except the handles.
- Handle with care and with more than two persons when moving this Display. Keep in mind that this Display is easy to break from carelessness.
- For wall or ceiling installation, we recommend installing this Display with metal brackets which are commercially available. For detailed installation instructions, refer to the guide received with the respective bracket.
- To lessen the probability of injury and damage resulting from fall of this Display in case of earthquake or other natural disaster, be sure to consult the bracket manufacturer for installation location.
- For portrait installation, please turn this Display right.

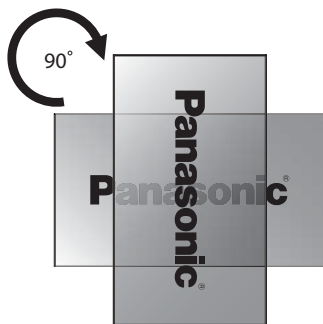
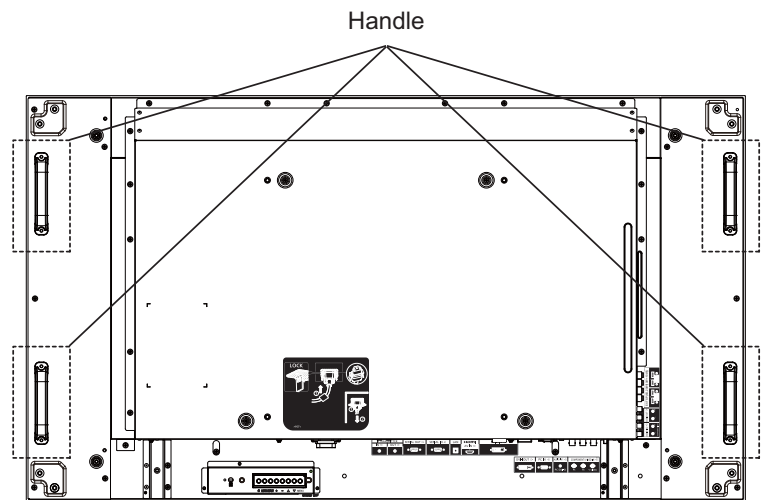

NOTE:

- Please do not rotate and use it for left-hand side.

Parts and Functions

Control Panel

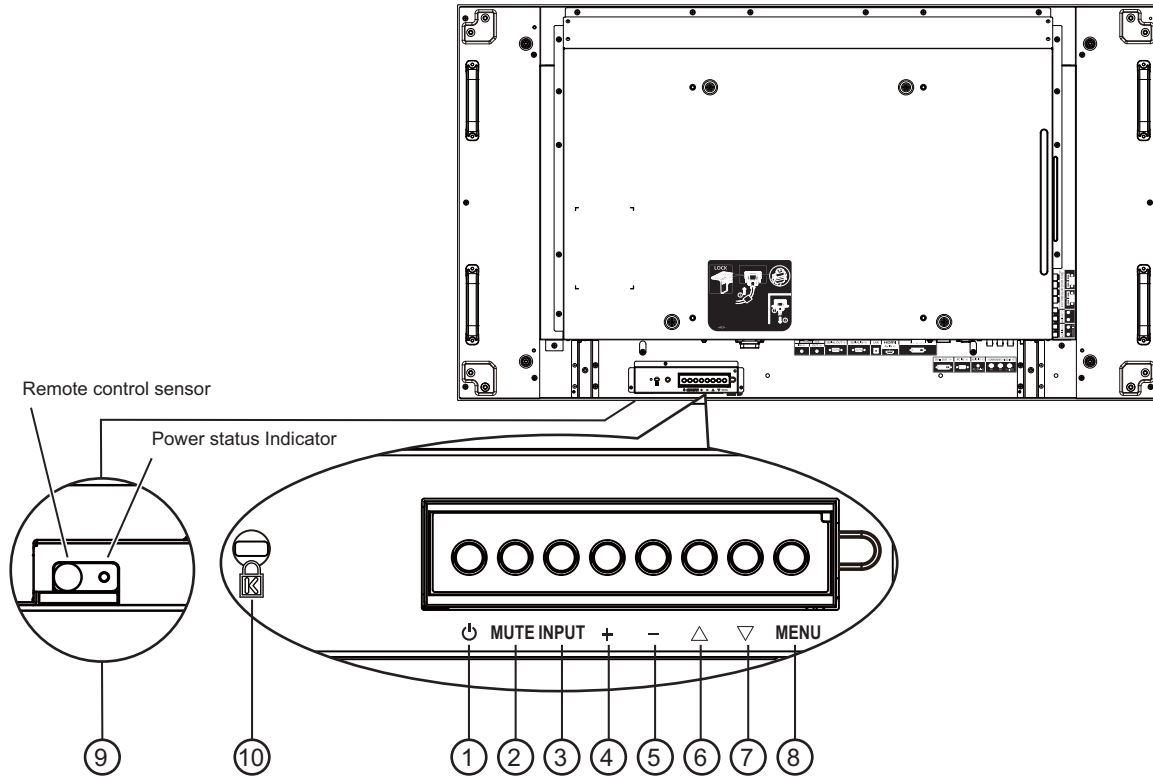

① POWER button

Use this button to turn this Display on or put this Display to standby.

② MUTE button

Switch the audio mute ON/OFF.

③ INPUT button

Use this button to select the input source.

- Used as [SET] button in the On-Screen-Display menu.

④ [▲] button

Increase the adjustment while OSD menu is on, or increase the audio output level while OSD menu is off.

⑤ [▼] button

Decrease the adjustment while OSD menu is on, or decrease the audio output level while OSD menu is off.

⑥ [▲] button

Move the highlight bar up to adjust the selected item while OSD menu is on.

⑦ [▼] button

Move the highlight bar down to adjust the selected item while OSD menu is on.

⑧ MENU button

Press to activate the OSD menu when OSD menu is off. Press to return to previous menu while OSD menu is on.

⑨ Remote control sensor and power status indicator

- Receives command signals from the remote control.
- Indicates the operating status of this Display:
 - Lights green when this Display is turned on
 - Lights red when this Display is in standby mode
 - Lights amber when this Display enters "Power Save" mode
 - When {SCHEDULE} is enabled, the light blinks amber and red
 - If the light blinks red, it indicates that a failure has been detected
 - Off when the main power of this Display is turned off

NOTE:

- The remote control sensor and power status indicator are arranged downward.

⑩ KENSINGTON LOCK

For security and theft prevention.

Input/Output Terminals

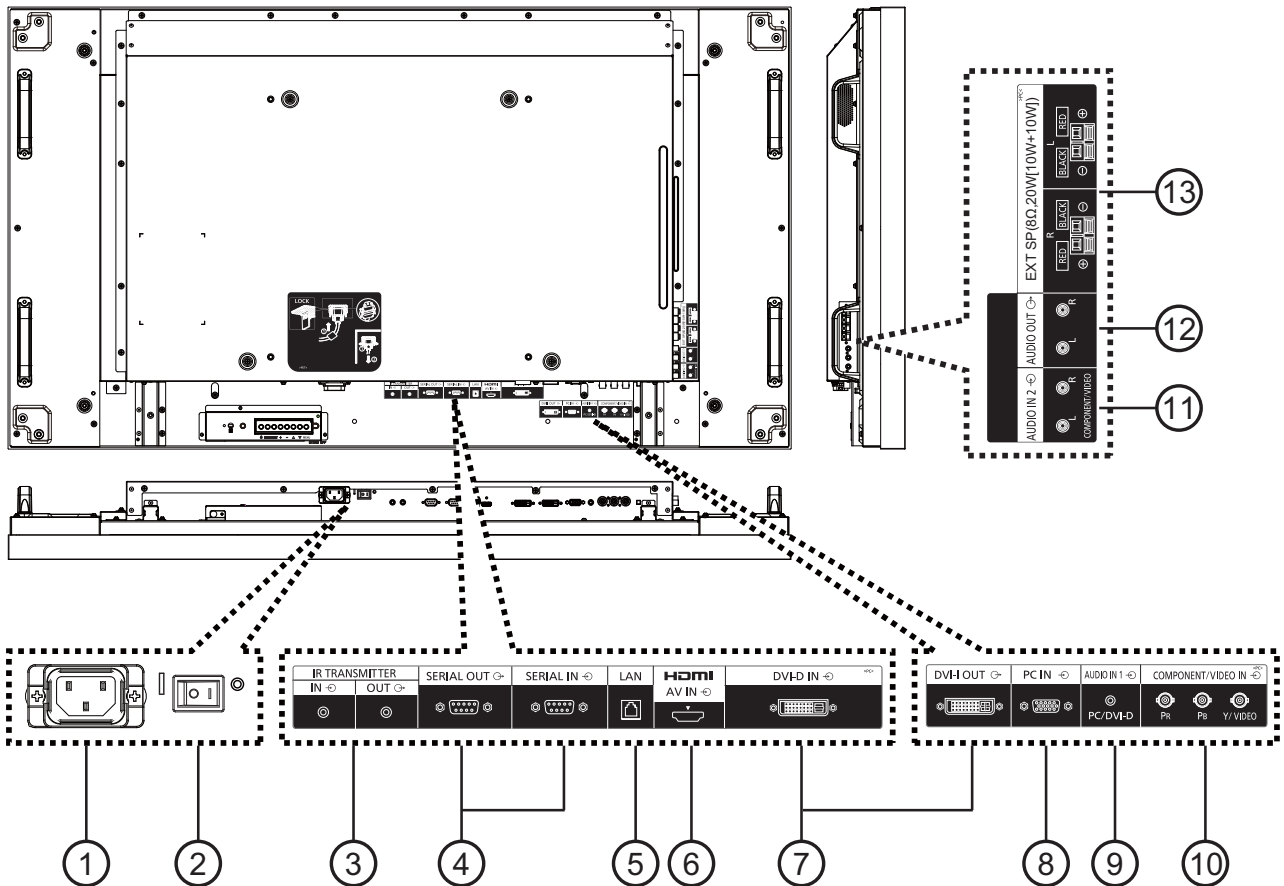

- ① **AC IN**
Connect the supplied power cord to the wall outlet.
- ② **MAIN POWER SWITCH**
Press to switch the main power on/off.
- ③ **IR TRANSMITTER IN / OUT**
Reserved for the wired connection of the IR control.
NOTE: If an optional IR receiver is connected to [IR TRANSMITTER IN], this Display's remote control sensor will stop working.
- ④ **SERIAL OUT / SERIAL IN**
RS232C network input/output connection for the use of loop-through function.
- ⑤ **LAN**
LAN control function for the use of remote control signal from control center.
- ⑥ **HDMI AV IN**
Input the HDMI source of an AV device, or the DVI-D output of a PC by using a DVI-HDMI cable.
- ⑦ **DVI-D IN / DVI-I OUT**
Digital video input and output connection.
- ⑧ **PC IN**
Input the PC source.
- ⑨ **AUDIO IN 1**
Input the PC audio source (3.5 mm stereo phone jack).
- ⑩ **COMPONENT/VIDEO IN (BNC)**
Input the component YPbPr source from external AV device.
For VIDEO input, connect with CVBS cable from the video output of your AV device to this Display's Y input (an after-market BNC-RCA adapter will be needed).
- ⑪ **AUDIO IN 2 (RCA)**
Input the audio source from external AV device.
- ⑫ **AUDIO OUT (RCA)**
Output the audio source connected from the AUDIO IN jack to an external AV device.
- ⑬ **SPEAKER OUT R/L -> EXT SP (8 Ω)**
Output the audio to your external speakers.

Connections

AC Cord Connection

1. Plug the AC cord into this Display.

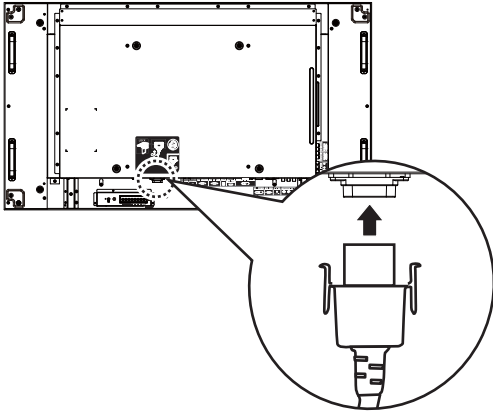

2. Plug the AC cord firmly until it clicks into position. Make sure the AC cord is locked on both the left and right sides.

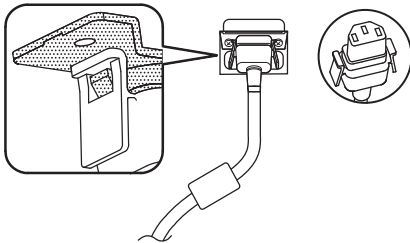

3. To unplug the AC cord, press the two knobs and pull.

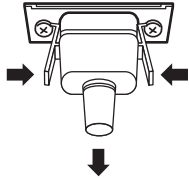

NOTE:

- When disconnecting the AC cord, be absolutely sure to disconnect the AC cord plug at the socket outlet first.

Cable Securing

There are three clampers supplied to secure cables at three positions.

1. Attach the clamber.

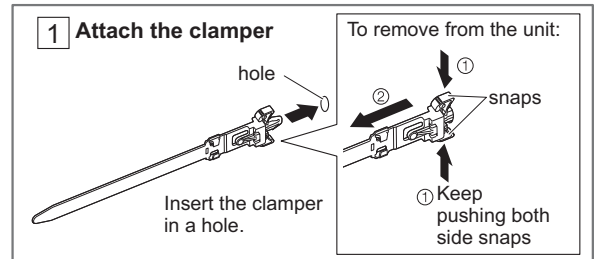
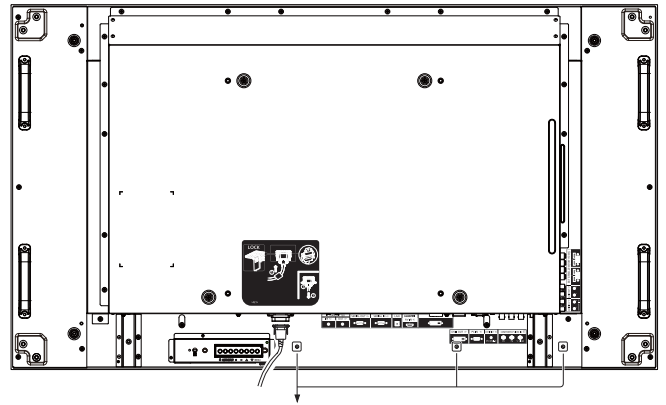

2. Bundle the cables.

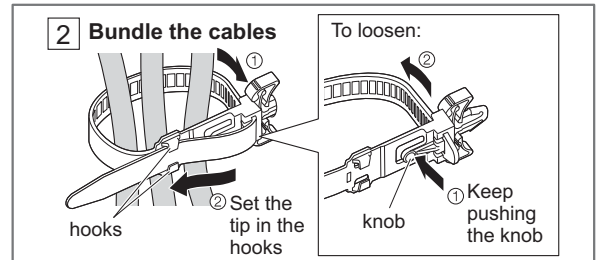

DVD/VCR/VCD Connection

Using COMPONENT input

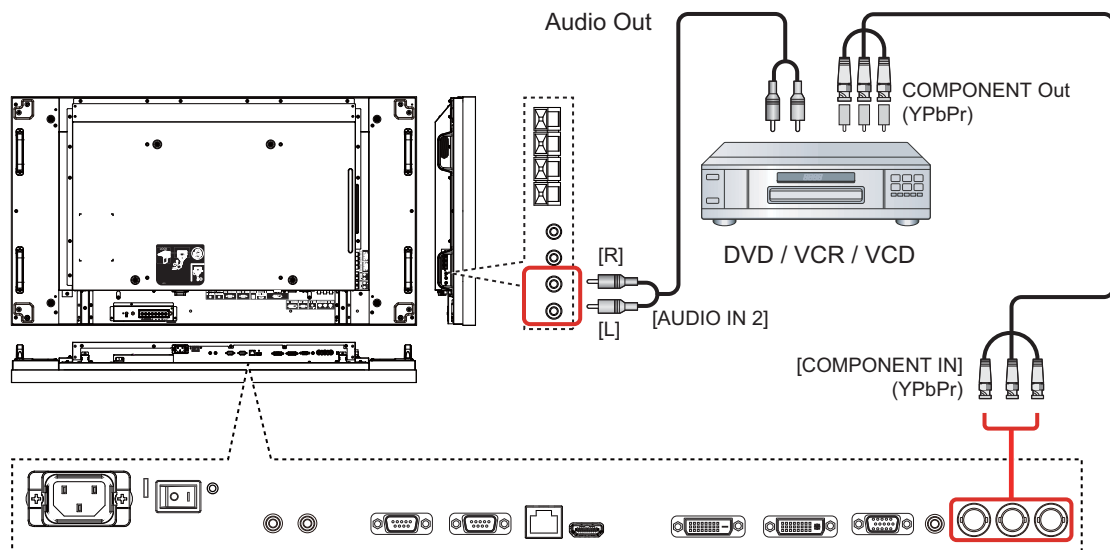

Using VIDEO input

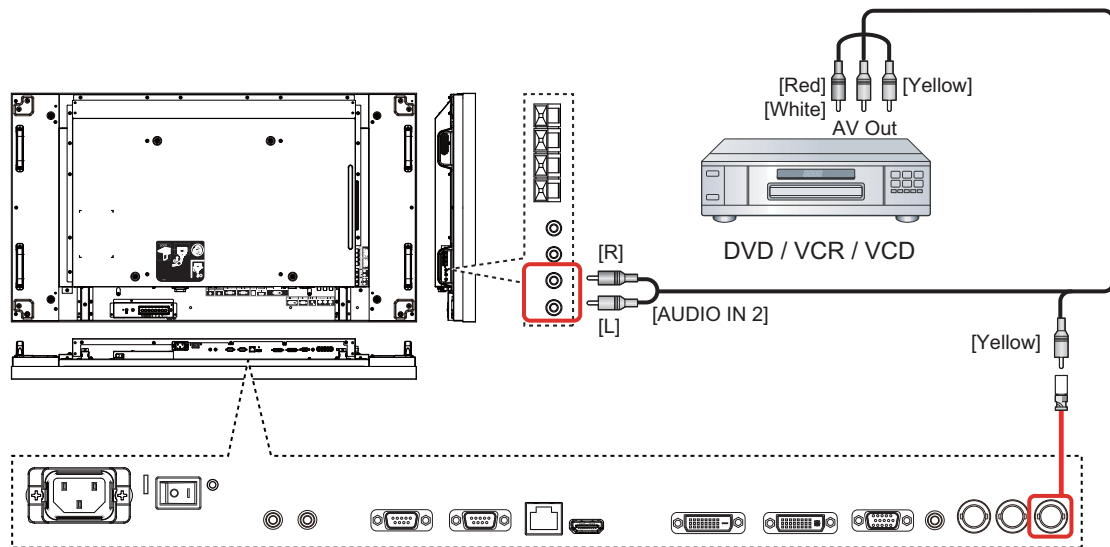

Using HDMI video input

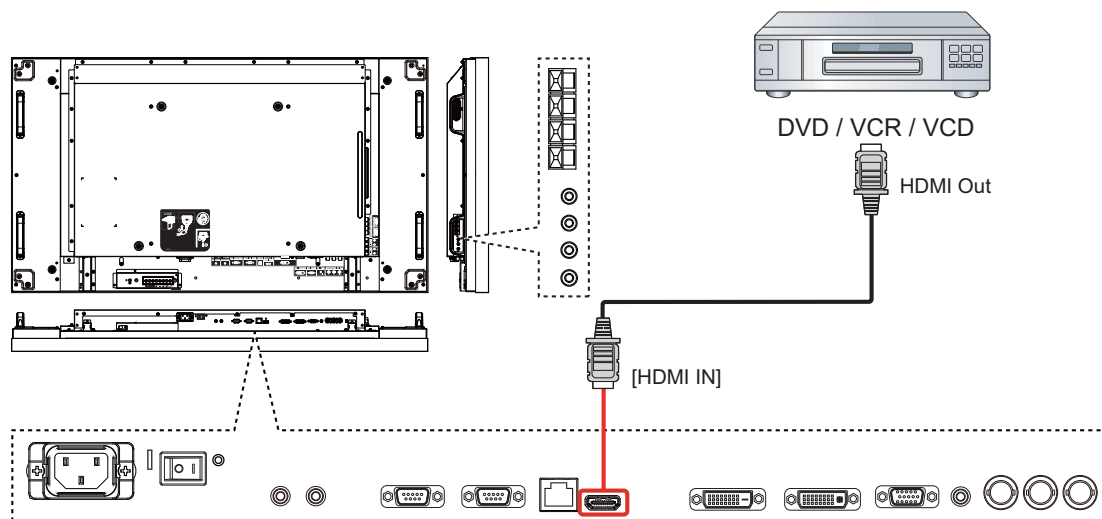

Pin assignments and signal names for HDMI terminal:

Pin No.	Signal Name	Pin No.	Signal Name
1	T.M.D.S. Data2 +	11	T.M.D.S. Clock Shield
2	T.M.D.S. Data2 Shield	12	T.M.D.S. Clock -
3	T.M.D.S. Data2 -	13	CEC
4	T.M.D.S. Data1 +	14	Reserved(N.C. on device)
5	T.M.D.S. Data1 Shield	15	SCL
6	T.M.D.S. Data1 -	16	SDA
7	T.M.D.S. Data0 +	17	DDC/CEC Ground
8	T.M.D.S. Data0 Shield	18	+5 V DC
9	T.M.D.S. Data0 -	19	Hot Plug Detect
10	T.M.D.S. Clock +		

PC Connection

Using PC input

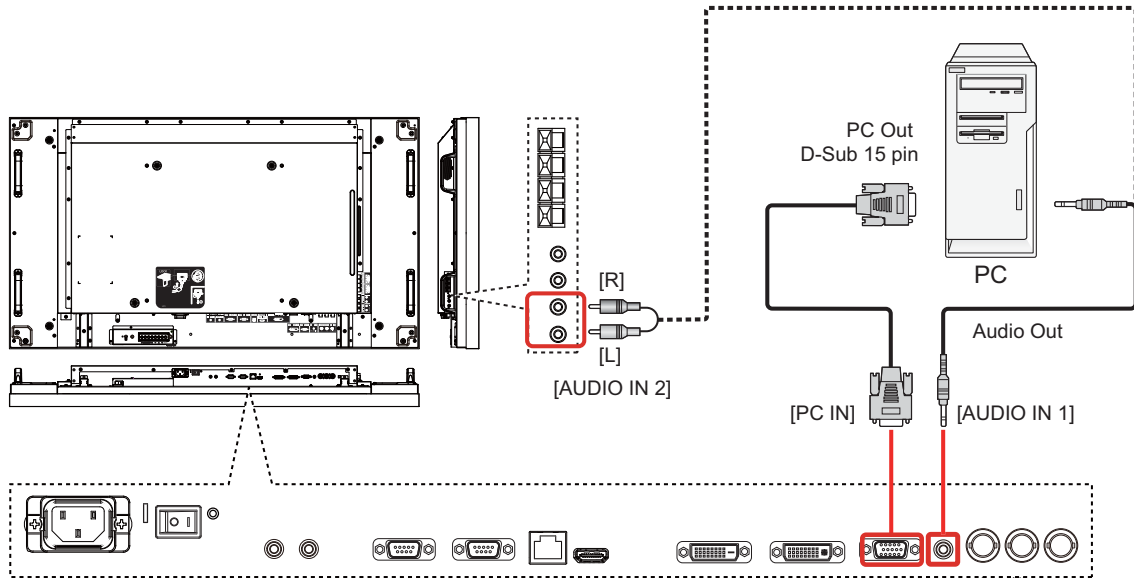

Signal names for mini D-sub 15-pin connector:

Pin No.	Signal Name	Pin No.	Signal Name	Pin No.	Signal Name
1	R	6	GND (Ground)	11	NC (not connected)
2	G	7	GND (Ground)	12	SDA
3	B	8	GND (Ground)	13	HD/SYNC
4	NC (not connected)	9	+5 V DC	14	VD
5	GND (Ground)	10	GND (Ground)	15	SCL

Using HDMI input

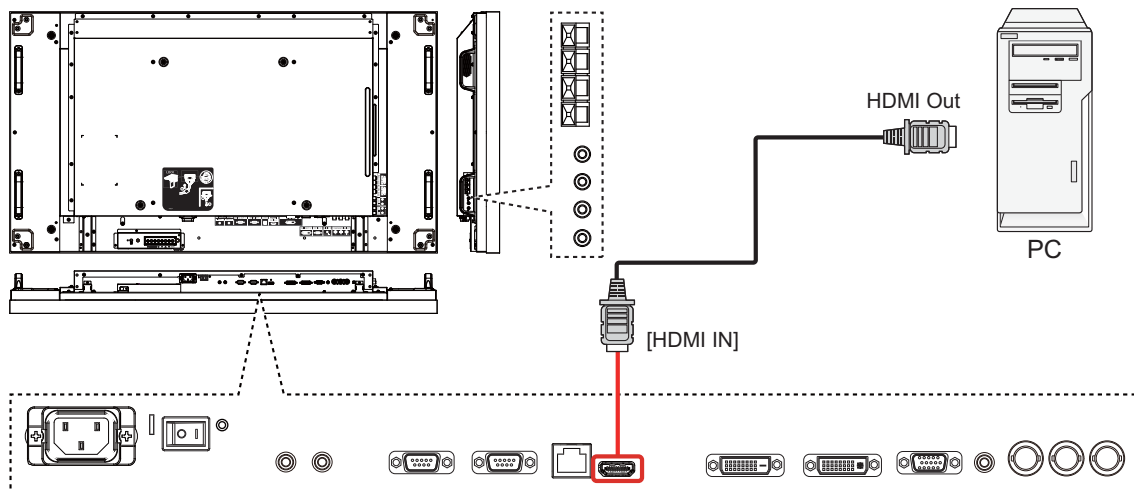

Using DVI input

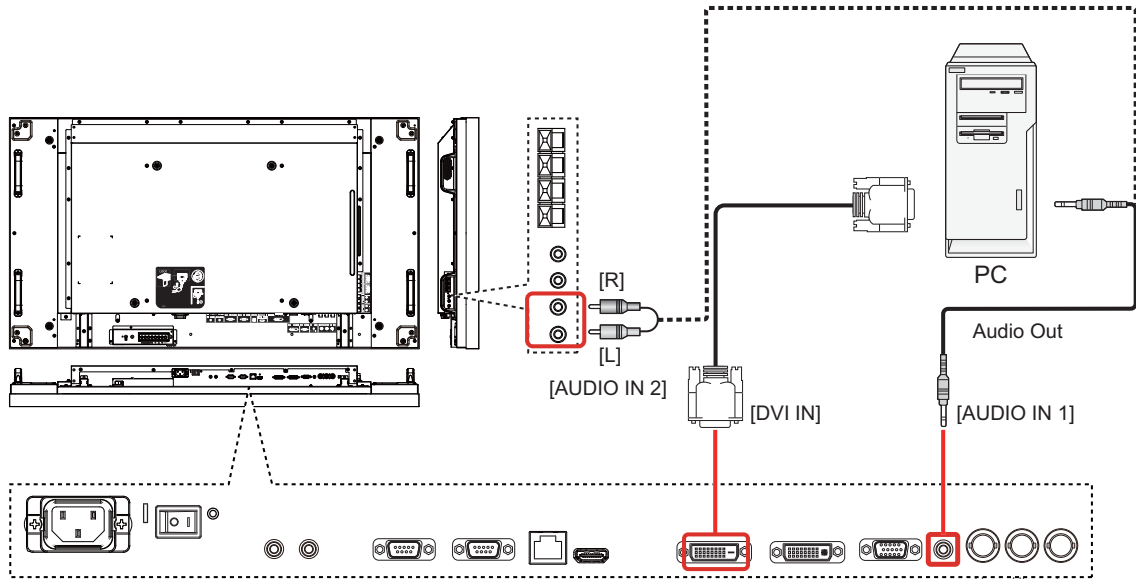

DVI-D Input Connector Pin Layouts:

Pin No.	Signal Name	Pin No.	Signal Name
1	T.M.D.S. Data2 -	13	—
2	T.M.D.S. Data2 +	14	+5 V DC
3	T.M.D.S. Data2 Shield	15	Ground
4	—	16	Hot Plug Detect
5	—	17	T.M.D.S. Data0 -
6	DDC Clock	18	T.M.D.S. Data0 +
7	DDC Data	19	T.M.D.S. Data0 Shield
8	—	20	—
9	T.M.D.S. Data1 -	21	—
10	T.M.D.S. Data1 +	22	T.M.D.S. Clock Shield
11	T.M.D.S. Data1 Shield	23	T.M.D.S. Clock +
12	—	24	T.M.D.S. Clock -

DVI-I Output Connector Pin Layouts:

Pin No.	Signal Name	Pin No.	Signal Name	Pin No.	Signal Name
1	T.M.D.S. Data2 -	13	—	C1	Analog Red
2	T.M.D.S. Data2 +	14	+5 V DC	C2	Analog Green
3	T.M.D.S. Data2 Shield	15	Ground	C3	Analog Blue
4	—	16	Hot Plug Detect	C4	Analog Horizontal Sync
5	—	17	T.M.D.S. Data0 -	C5	Analog Ground
6	DDC Clock	18	T.M.D.S. Data0 +		
7	DDC Data	19	T.M.D.S. Data0 Shield		
8	Analog Vertical Sync	20	—		
9	T.M.D.S. Data1 -	21	—		
10	T.M.D.S. Data1 +	22	T.M.D.S. Clock Shield		
11	T.M.D.S. Data1 Shield	23	T.M.D.S. Clock +		
12	—	24	T.M.D.S. Clock -		

External Audio Connection

Using audio out

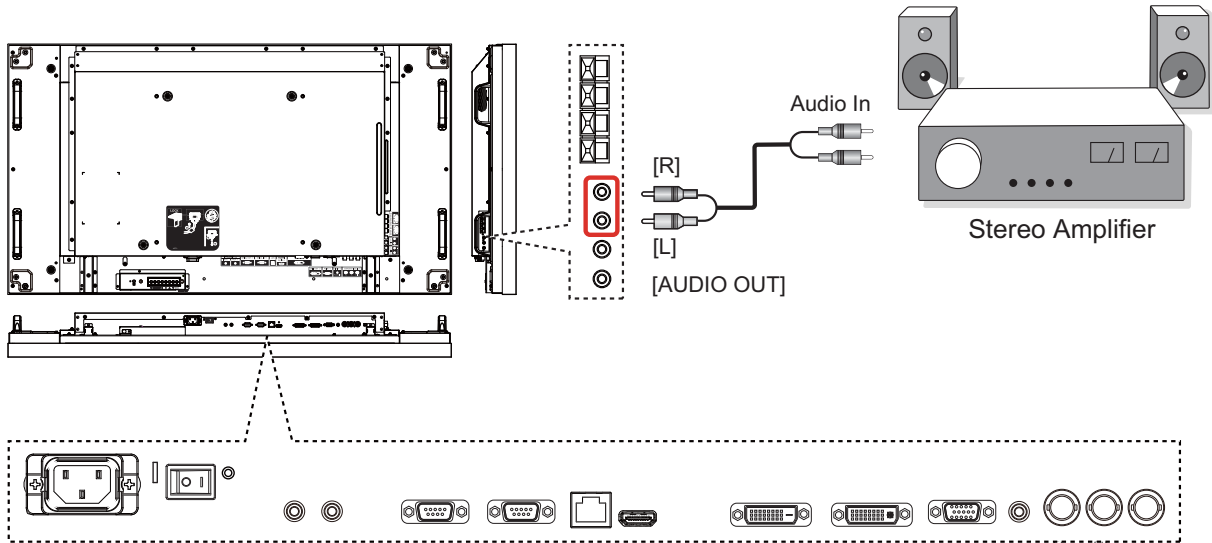

Using speakers out

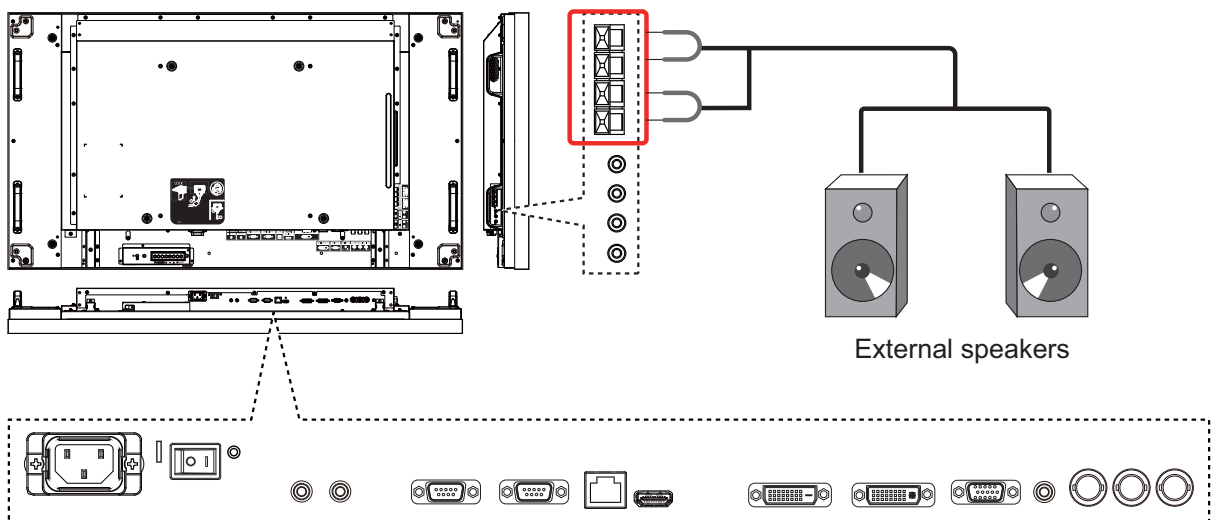

To connect the speaker wire:

1. While pressing the lever, insert the core wire.
2. Return the lever.

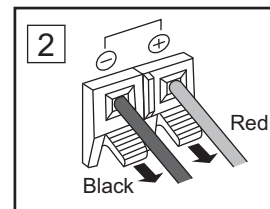
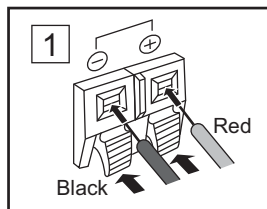

SERIAL Terminals Connection

The SERIAL terminal is used when this Display is controlled by a computer.

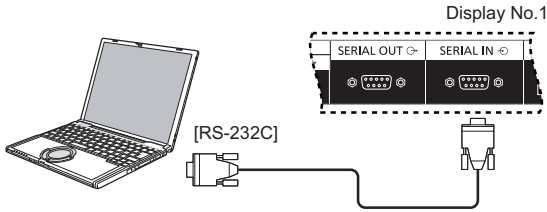

NOTES:

- Use the RS-232C cross cable to connect the computer to this Display.
- The computer shown is for example purposes only.
- Additional equipment and cables shown are not supplied with this set.

The SERIAL terminal conforms to the RS-232C interface specification, so that this Display can be controlled by a computer which is connected to this terminal.

The computer will require software which allows the sending and receiving of control data which satisfies the conditions given below. Use a computer application such as programming language software. Refer to the documentation for the computer application for details.

Signal names for SERIAL IN terminal:

	Pin No.	Signal Name
	1	DCD
	2	RXD
	3	TXD
	4	DTR
	5	GND
	6	DSR
	7	RTS
	8	CTS
	9	RI

These signal names are those of computer specifications.

Communication parameters:

Signal level	RS-232C compliant
Synchronization method	Asynchronous
Baud rate	9600 bps
Parity	None
Character length	8 bits
Stop bit	1 bit
Flow control	-

Basic format for control data:

The transmission of control data from the computer starts with Header byte, followed by the command, the parameters, and lastly byte of checksum in that order. If there are no parameters, then the parameter signal does not need to be sent.

Header	MonitorID	Category	Code0	Code1	Length	Control	Data[0]	Data[1]	~	Data[N]	Checksum
0xA6	0~26	0x00	0x00	0x00	N+3	0x01	Command			Parameter	The total from Header to Data[N] calculated by XOR

NOTES:

- Multiple commands are transmitted, be sure to wait for the response for the first command to come from this unit before sending the next command.
- If an incorrect command is sent by mistake, this unit will send an "ERROR" command back to the computer.

Command:

Command	Parameter	Control Details
0x19	None	Get Power State
0x18	0x01	POWER OFF
0x18	0x02	POWER ON
0x45	None	Get Volume
0x44	0~100	Set Volume
0xAC	0x01, 0x00, 0x00, 0x00	Change source to VIDEO
0xAC	0x03, 0x00, 0x00, 0x00	Change source to DVD/HD
0xAC	0x09, 0x01, 0x00, 0x00	Change source to DVI
0xAC	0x09, 0x00, 0x00, 0x00	Change source to HDMI
0xAC	0x05, 0x00, 0x00, 0x00	Change source to PC
0x3B	None	Get picture format
0x3A	0x00	Change picture format to Normal
0x3A	0x01	Change picture format to Custom
0x3A	0x02	Change picture format to Real
0x3A	0x03	Change picture format to Full

Daisy-chain Connection

You can interconnect multiple displays to create a daisy-chain configuration for video wall applications.

NOTES:

- Use the RS-232C cross cable to connect the computer to this Display.
- The computer shown is for example purposes only.
- A DVI cable and IR cable are attached.
- When using daisy chain, set the “**TILING**” menu option in the OSD “**CONFIGURATION2 menu**”. (see page 27)
- Up to 10 displays can be connected with a daisy chain, but the number of the connected displays may be limited by a cable signal or equipment to use.
- HDCP can be supported for up to 8 displays for a daisy chain.

Display control connection (RS-232C Cable)

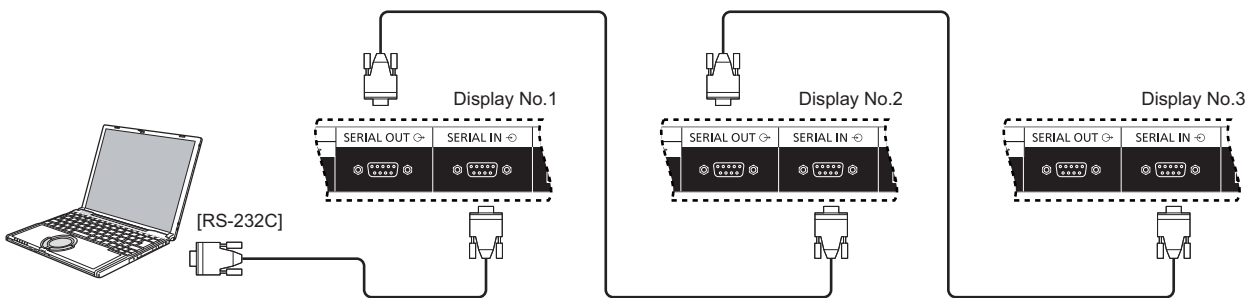

Digital video connection (DVI Cable)

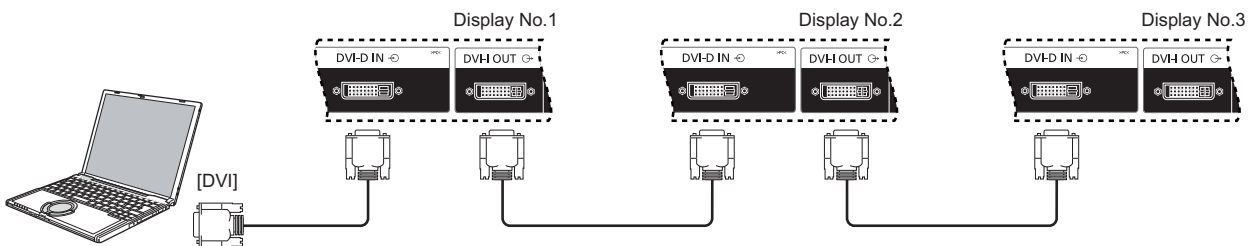

External IR Connection (Optional)

With the optional “Remote Control Kit” (TY-RM50VW), you can specify the Display ID for daisy-chain connection.

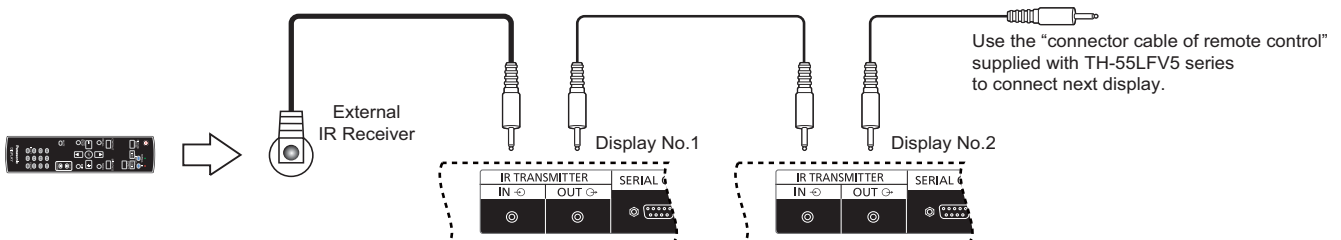

Using Network Function

This display has a network function to control the network connected display with your computer.

NOTE:

- To use the network function, set each {LAN SETTING} setting and make sure to set the {SERIAL CONTROL} to {LAN}. (see page 20, 29)

Network Connection

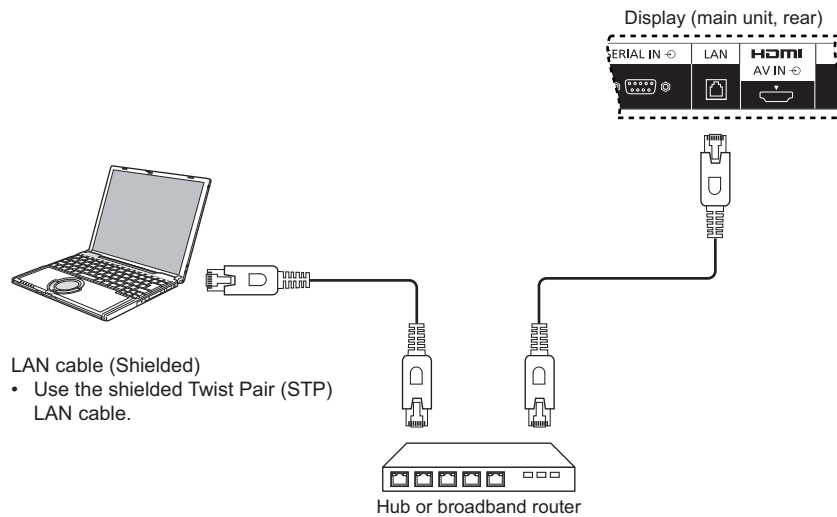

NOTES:

- Make sure your broadband router or hub supports 10BASE-T/100BASE-TX.
- To connect a device using 100BASE-TX, use "Category 5 or above" LAN cable (not included).
- Touching the LAN terminal with a statically charged hand (body) may cause damage due to its discharge. Do not touch the LAN terminal or a metal part of the LAN cable.
- For instructions on how to connect, consult your network administrator.

OSD Menu Setup for Network Connection

To proceed the network setting, you will have to enter the OSD menu.

SERIAL CONTROL:

Select {LAN} as the network control port.

1. Press [MENU] button on this Display's control.
2. Press [▲] or [▼] button to select the {ADVANCED OPTION} menu.
3. Press [INPUT] button to enter the submenu.
4. In the submenu, press [▲] or [▼] button to select the {SERIAL CONTROL} menu, press [+] or [-] button to select {LAN}.

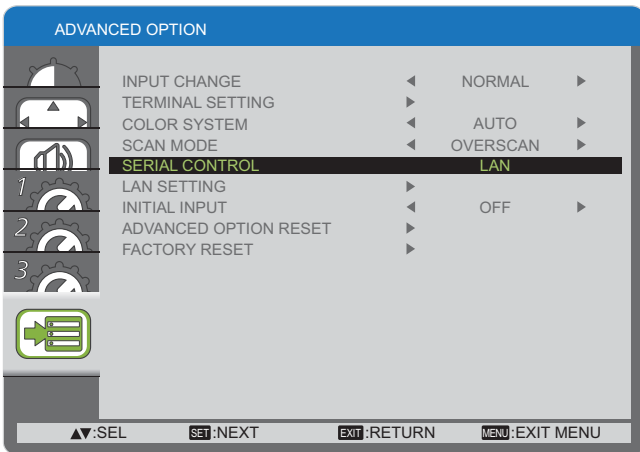

5. Press [MENU] button to return to the previous menu, or press [MENU] button several times to exit the OSD menu.

LAN SETTING:

Assign {IP ADDRESS}, {SUBNET MASK}, and {DEFAULT GATEWAY} for this Display.

NOTE:

- The {LAN SETTING} is available only after setting the {SERIAL CONTROL} to {LAN}.
1. Press [MENU] button on this Display's control.
 2. Press [▲] or [▼] button to select the {LAN SETTING} menu.
 3. Press [INPUT] button to enter the submenu.

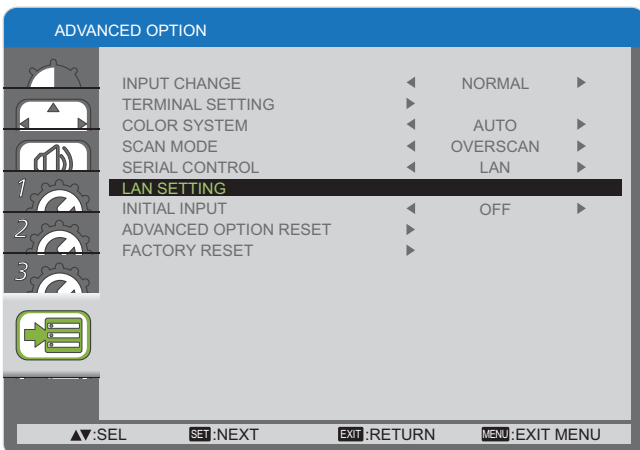

4. In the submenu, press [▲] or [▼] button to select the {DHCP CLIENT} menu, press [+] or [-] button to select {ON}.

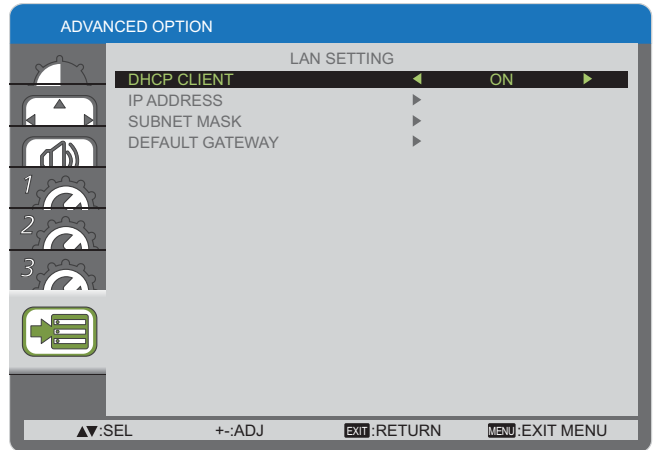

5. Press [MENU] button to return to the previous menu, or press [MENU] button several times to exit the OSD menu.

DHCP CLIENT

To obtain an IP address automatically using a DHCP server, set this to {ON}. If DHCP server is not used, set this to {OFF}.

IP ADDRESS

Enter an IP address if DHCP server is not used.

SUBNET MASK

Enter a subnet mask if DHCP server is not used.

DEFAULT GATEWAY

Enter a gateway address if DHCP server is not used.

NOTES:

- To use a DHCP server, make sure the DHCP server is started.
- Contact your network administrator for details on settings.

Using Web Browser Control

You can use a Web browser to control this Display and set up a network and password.

NOTE:

- The “**Web Browser Control**” is currently supported with Windows IE6, IE7, or IE8.

Before Using Web Browser Control

To use the Web browser control, the Display and computer setups are required.

Display Setup

Set each {**LAN SETTING**} setting and make sure to set the {**SERIAL CONTROL**} to {**LAN**} (see page 20, 29).

Computer Setup (for Windows operating system)

Disable proxy server settings

1. Display [Internet Properties] window.
Click [Start] → [Control Panel] → [Network and Internet Connections] → [Internet Options].
2. Click the [Connections] tab and then [LAN Settings].
3. Deselect the [Use automatic configuration script] and [Use a proxy server for your LAN] boxes.
4. Click [OK].

Enable JavaScript

1. Display [Internet Properties] window.
Click [Start] → [Control Panel] → [Network and Internet Connections] → [Internet Options].
2. Set the security level on the [Security] tab to [Default Level]. Alternatively enable [Active scripting] from the [Custom Level] button.

Access from Web Browser

Access to the TOP screen of the Web browser control using a Web browser.

1. Start your Web browser.
2. Enter the IP address from the {IP ADDRESS} set with the {LAN SETTING} of this Display (see page 20, 29).

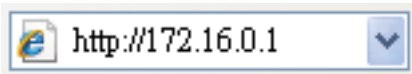

3. Enter the {Username} and {Password} when the Authentication screen is displayed.

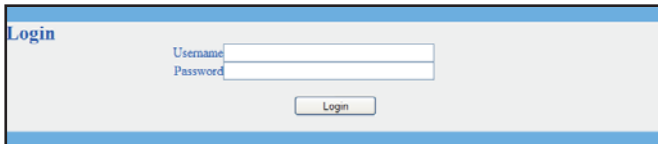

Authentication screen

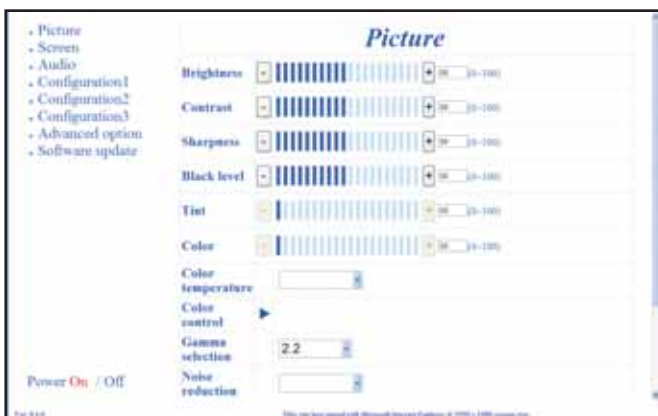

4. Click [OK].

NOTES:

- Default {Username} and {Password} are as follows:
{Username}: admin
{Password}: 0000
- Panasonic Corporation and its affiliated companies never directly ask customers for their password. Do not give out your password even if directly asked by a third-party representing themselves as Panasonic Corporation.

On-Screen Display Menu

Entering the OSD Menu

Using this Display's control buttons

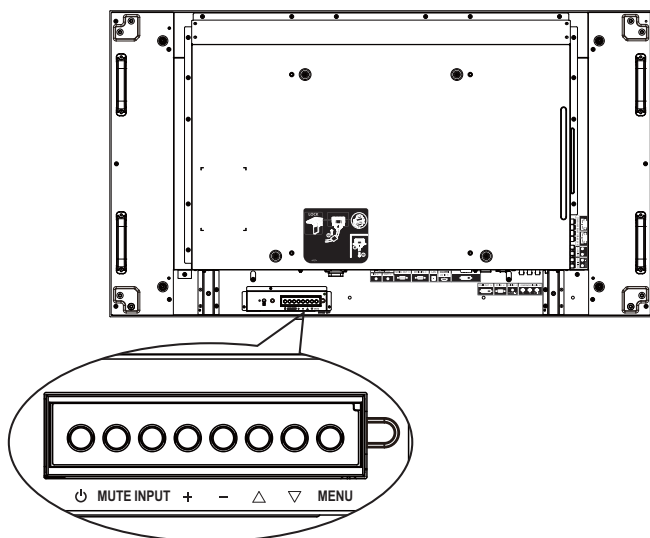

1. Press **[MENU]** button to display the OSD menu.
2. Press **[▲]** or **[▼]** button to choose the item you want to adjust.
3. Press **[INPUT]** button to enter the submenu.
4. In the submenu, press **[▲]** or **[▼]** button to toggle among items, press **[+]** or **[-]** button to adjust settings. If there is a submenu, press **[INPUT]** button to enter the submenu.
5. Press **[MENU]** button to return to the previous menu, or press **[MENU]** button several times to exit the OSD menu.

OSD Menu Overview

PICTURE menu

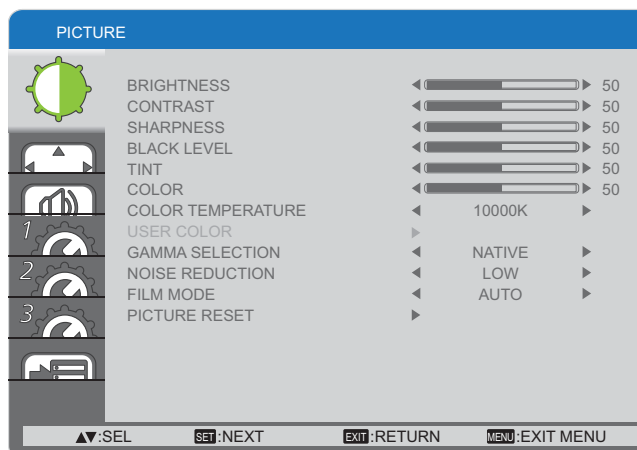

BRIGHTNESS

Adjust the overall image brightness by changing the intensity of the LCD panel's backlight.

CONTRAST

Adjust to sharpen the picture quality. The black portions of the picture become richer in darkness and the white become brighter.

SHARPNESS

Adjust to improve the image detail.

BLACK LEVEL

Adjust to change the image brightness.

TINT

Press the **[+]** button and the flesh tone color turns slightly purple. Press the **[-]** button and the flesh tone color turns slightly green.

NOTE: This item is functional for **HDMI**, **DVD/HD**, and **VIDEO** inputs only.

COLOR

Adjust to increase or decrease the intensity of colors in the image.

NOTE: This item is functional for **HDMI**, **DVD/HD**, and **VIDEO** inputs only.

COLOR TEMPERATURE

Select a color temperature for the image. A lower color temperature will have a reddish tint, whilst a higher color temperature gives off a more bluish tint.

The options are: **{3000K}** / **{4000K}** / **{5000K}** / **{6500K}** / **{7500K}** / **{9300K}** / **{10000K}** / **{NATIVE}** / **{USER}**.

USER COLOR

With this function you can adjust the color tones of the image precisely by changing the R (Red), G (Green) and B (Blue) settings independently.

NOTE: This item is functional only when **{COLOR TEMPERATURE}** is set to **{USER}**.

GAMMA SELECTION

Gamma is what controls the overall brightness of an image. Images which are not corrected properly can appear too white or too dark, so controlling the gamma properly can have a huge influence on the overall picture quality of your display.

The options are: **{NATIVE}** / **{2.2}** / **{2.4}** / **{S GAMMA}**.

NOISE REDUCTION

Adjust to remove the noise in the image. You can select a suitable noise reduction level.

The options are: **{OFF}** / **{LOW}** / **{MIDDLE}** / **{HIGH}**.

NOTE: This item is functional for **HDMI, DVD/HD,** and **VIDEO** inputs only.

FILM MODE

Choose to turn on or off the film mode frame conversion function.

- **{AUTO}** - Enable the film mode frame conversion function for movies and motion pictures. The display converts a 24 frames-per-second (24 fps) input signal format to DVD video signal format.
- **{OFF}** - Disable the film mode frame conversion function. This mode is suitable for TV broadcasting and VCR signals.

NOTE: This item is functional for **HDMI, DVD/HD,** and **VIDEO** inputs only.

PICTURE RESET

Reset all settings in the Picture menu to factory preset values.

SCREEN menu

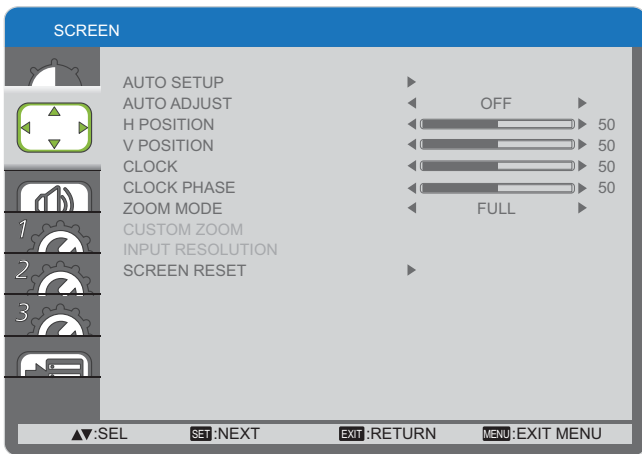

AUTO SETUP

Use this function to let this Display automatically optimize the display of PC input image.

NOTE: This item is functional for **PC** input only.

AUTO ADJUST

Choose to let this Display detect and display available signal sources automatically.

- **{ON}** - Set this Display to display the image automatically once a signal is connected.
- **{OFF}** - Once a signal is connected, it can only be selected manually.

NOTE: This item is functional for **PC** input only.

H POSITION

Press the **[+]** button to move the image to the right, or **[-]** to move the image to the left.

NOTE: This item is functional for **PC** input only.

V POSITION

Press the **[+]** button to move the image up, or **[-]** to move the image down.

NOTE: This item is functional for **PC** input only.

CLOCK

Adjust the width of the image.

NOTE: This item is functional for **PC** input only.

CLOCK PHASE

Adjust to improve the focus, clarity and stability of the image.

NOTE: This item is functional for **PC** input only.

ZOOM MODE

The pictures you receive may be transmitted in 16:9 format (wide screen) or 4:3 format (conventional screen). The 16:9 pictures sometimes have a black band at the top and bottom of the screen (letterbox format).

This function allows you to optimize the picture display on screen. The following zoom modes are available for:

- PC mode: **{FULL}** / **{NORMAL}** / **{CUSTOM}** / **{REAL}**.
- Video mode: **{FULL}** / **{NORMAL}** / **{CUSTOM}** / **{REAL}**.



	FULL This mode restores the correct proportions of pictures transmitted in 16:9 using the full screen display.
	NORMAL The picture is reproduced in 4:3 format and a black band is displayed on either side of the picture.
	CUSTOM Choose to apply the custom zoom settings in the Custom Zoom submenu.
	REAL This mode displays the image pixel-by-pixel on screen without scaling the original image size.

CUSTOM ZOOM

You can use this function to further customize the zoom settings to suit the image you want to display.

NOTE: This item is functional only when the **{ZOOM MODE}** setting is set to **{CUSTOM}**.

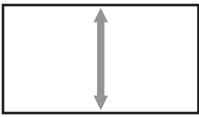
	ZOOM Expands the horizontal and vertical sizes of the image simultaneously.
	H ZOOM Expands the horizontal size of the image only.

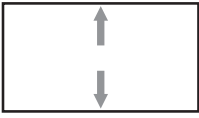
	V ZOOM Expands the vertical size of the image only.
	H POSITION Moves the horizontal position of the image left or right. NOTE: This item is functional for PC input only.
	V POSITION Moves the vertical position of the image up or down. NOTE: This item is functional for PC input only.

INPUT RESOLUTION

Set the resolution of the PC input. This is only required when this Display is unable to detect the PC input resolution correctly.

NOTE: This item is functional for PC input only.

The options are:

- {1024x768 / 1280x768 / 1360x768 / 1366x768}
- {1400x1050 / 1680x1050}
- {1600x1200 / 1920x1200}
- {Auto}: Determines the resolution automatically.

The selected settings will become effective after turning off the power and turn it on again.

SCREEN RESET

Reset all settings in the **SCREEN** menu to factory preset values.

AUDIO menu

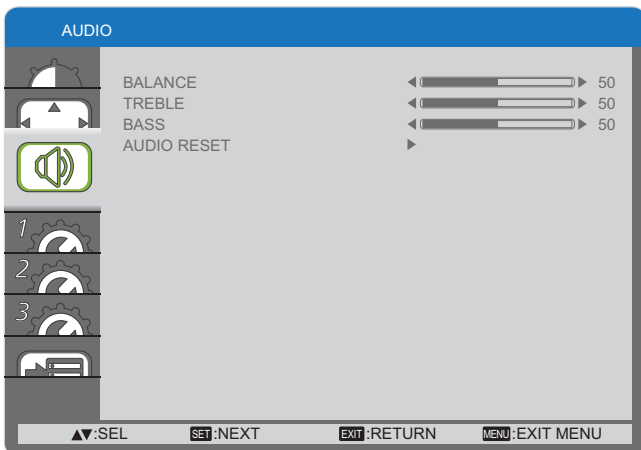

BALANCE

Adjust to emphasize left or right audio output balance.

TREBLE

Adjust to increase or decrease higher-pitched sounds.

BASS

Adjust to increase or decrease lower-pitched sounds.

AUDIO RESET

Reset all settings in the **AUDIO** menu to factory preset values.

CONFIGURATION1 menu



OFF TIMER

Set this Display to turn itself off to standby mode within an amount of time specified.

The options are: {OFF, 1HOUR ~ 24HOURS} from current time.

SCHEDULE

This function allows you to program up to 7 (seven) different scheduled time intervals for this Display to activate.

You can select:

- The time for this Display to turn on and turn off.
- The days in a week for this Display to activate.
- Which input source this Display will use for each scheduled activation period.

NOTE: You should set up current date and time in {DATE AND TIME} menu before using this function.

1. Press [SET] button to enter the submenu.

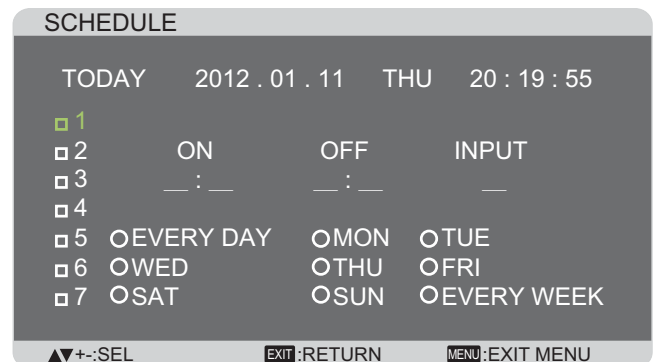

2. Press [▲] or [▼] button to select a schedule item (item number 1 ~ 7), and then press [SET] button to mark it the item number.

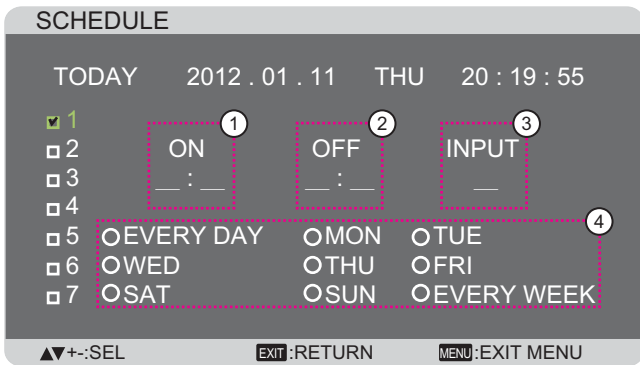

- Press **[+]** or **[-]** button to select the schedule:
 - POWER-ON** schedule: Press **[▲]** or **[▼]** button to set the hour and minute for this Display to turn on.
 - POWER-OFF** schedule: Press **[▲]** or **[▼]** button to set the hour and minute for this Display to turn off. Select or leave an empty “_” for both the hour and minute slot if you do not want to use this power-on or power-off schedule.
 - INPUT-SOURCE** selection: Press **[▲]** or **[▼]** button to select an input source. If no input source is selected, the input source will remain the same as last selected.
 - DATE** schedule: Press **[+]** button to select which day in a week this schedule item will be take effect, and then press the **[SET]** button.
- For more schedule settings, press **[EXIT]** button and then repeat the steps above. A check mark in the box next to the number of the schedule item indicates that the selected schedule is in effect.

NOTES:

- The **{EVERY DAY}** selection in a schedule item takes priority over the other weekly schedules.
- If the schedule overlap, the scheduled power-on time takes priority over scheduled power-off time.
- If there are two schedule items programmed for the same time, the highest numbered schedule takes priority. For example, if schedule items #1 and #2 both set this Display to power on at 7:00 AM and off at 5:00 PM, then only schedule item # 1 will take effect.

DATE AND TIME

Adjust the current date and time for this Display's internal clock.



- Press **[SET]** button to enter the submenu.
- Press **[▲]** or **[▼]** button to toggle among the **{YEAR}**, **{MONTH}**, **{DAY}**, **{HOUR}**, **{MINUTE}**, and **{DAYLIGHT SAVING TIME}** settings.
- Press **[+]** or **[-]** button to adjust all settings except **{DAYLIGHT SAVING TIME}**.

CONFIGURATION1 RESET

Reset all settings in the **CONFIGURATION1** menu to factory preset values.

CONFIGURATION2 menu

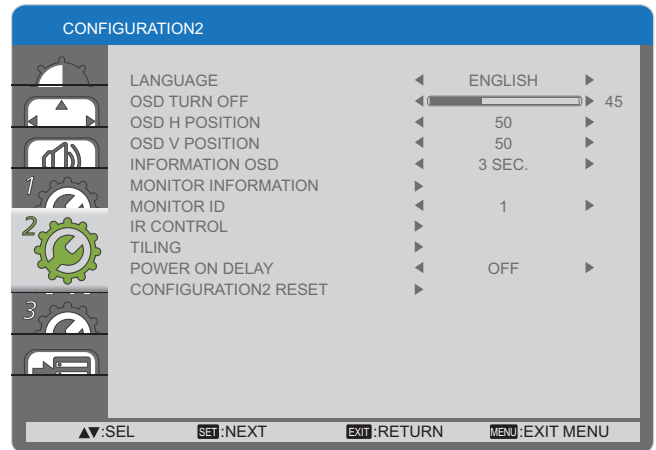

LANGUAGE

Select the language used in the OSD menu.

The options are: **{ENGLISH}** / **{DEUTSCH}** / **{FRANÇAIS}** / **{ITALIANO}** / **{ESPAÑOL}** / **{SVENSKA}** / **{日本語}** / **{中文}** / **{РУССКИЙ}**.

OSD TURN OFF

Set the period of time the OSD menu stays on the screen.

The options are: **{5 ~ 120}** seconds.

OSD H POSITION

Adjust the horizontal position of the OSD menu.

OSD V POSITION

Adjust the vertical position of the OSD menu.

INFORMATION OSD

Set the period of time the information OSD displayed on the upper right corner of the screen. The information OSD will display when input signal is changed.

The information OSD will not appear on the screen with **{OFF}** selection.

The options are: **{OFF, 3 SEC. ~ 10 SEC.}**.

MONITOR INFORMATION

Displays the information about your display, including **MODEL NAME** and **SERIAL**.

MONITOR ID

Set the ID number for controlling this Display via the RS232C connection or by ID Remote Control. Each display must have a unique ID number when multiple sets of this Display are connected.

IR CONTROL

Select the operation mode of the remote control unit.

- **{NORMAL}** - All displays can be operated normally by the remote control.
- **{LOCK}** - Lock the remote control function of this Display. To unlock, press and hold the [RECALL] button on the remote control for 5 (five) seconds.

TILING

With this function you can create a single large-screen matrix (video wall) that consists of up to **25** sets of this Display (up to 5-set each at the vertical and horizontal side).



Example: 2 × 2 screen matrix (4 displays)

H MONITORS = 2 displays
V MONITORS = 2 displays

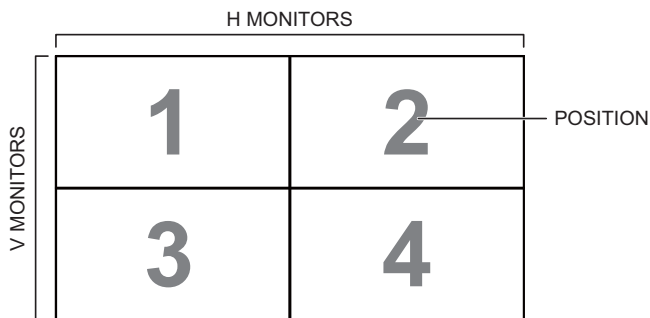

Example: 5 × 5 screen matrix (25 displays)

H MONITORS = 5 displays
V MONITORS = 5 displays

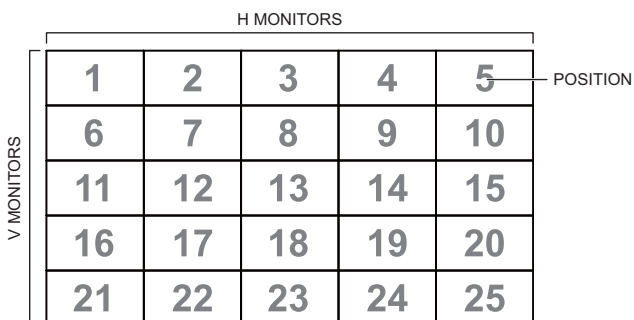

- **H MONITORS** - Select the number of displays on the horizontal side.
- **V MONITORS** - Select the number of displays on the vertical side.
- **POSITION** - Select the position of this Display in the screen matrix.
- **FRAME COMP.** - Choose to turn the frame compensation function on or off. If turned on, this Display will adjust the image to compensate for the width of this Display bezels in order to accurately display the image.

- **ENABLE**: Choose to enable or disable the Tiling function. If enabled, this Display will apply the settings in **{H MONITORS}**, **{V MONITORS}**, **{POSITION}**, and **{FRAME COMP.}**.

POWER ON DELAY

Select the delayed time until the power-on mode is activated after the power is turned on manually or automatically. This setting is useful in hiding start-up messages and powering on the connected devices at different timings.

The options are: **{OFF}**, **{2 SEC.}**, **{4 SEC.}**, **{6 SEC.}**, **{8 SEC.}**, **{10 SEC.}**, **{20 SEC.}**, **{30 SEC.}**, **{40 SEC.}**, **{50 SEC.}**.

CONFIGURATION2 RESET

Reset all settings in the **CONFIGURATION2** menu to factory preset values.

CONFIGURATION3 menu

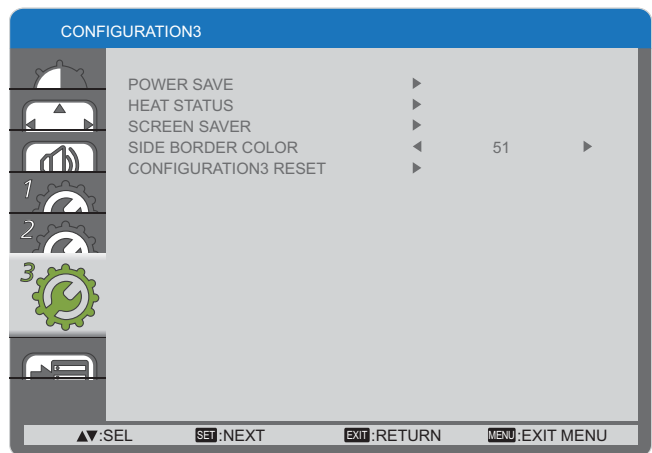

POWER SAVE

Set this Display to reduce the power automatically.



- **{RGB}** - Select **{ON}** to let this Display enter power saving mode with no signal detected from the **HDMI**, **DVI**, or **PC** inputs after 30 seconds.
- **{VIDEO}** - Select **{ON}** to let this Display enter power saving mode with no signal detected from the **VIDEO** or **DVD/HD** inputs after 30 minutes.

HEAT STATUS

This function allows you to check the thermal status of this Display at any time.

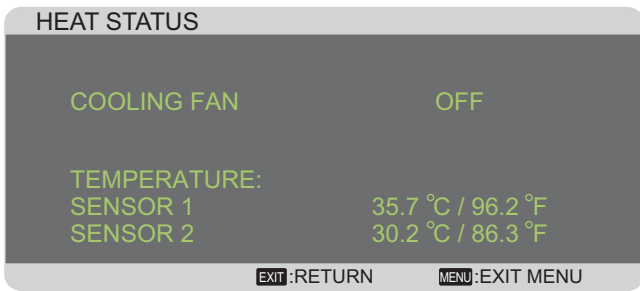

SCREEN SAVER

Choose to enable the panel saving functions to reduce the risk of the "image persistence".



- **{COOLING FAN}** - Select **{ON}** to turn on the cooling fan all the time. Select **{AUTO}** to turn on/off the cooling fan according to this Display's temperature.

NOTES:

- The default **{AUTO}** option will start running the cooling fan if the temperature of **65 °C (152 °F)** is reached, and will keep running for **30** minutes after cooling down to the temperature of **62 °C (144 °F)**.
- A temperature-warning message will be shown on the screen once the temperature reaches **79 °C**. All key function except **[Power]** key will then be disabled.
- Once the temperature reaches **80 °C (176 °F)**, this Display's power will be shut down automatically.
- **{BRIGHTNESS}** - Select **{ON}** and the brightness of the image will be reduced to an appropriate level, and the Brightness setting in the Picture menu will become unavailable.
- **{MOTION}** - Select the time interval (**{10 ~ 900}** Seconds / **{OFF}**) for this Display to slightly expand the image size and shift the position of pixels in four directions (up, down, left, or right).

SIDE BORDER COLOR

Adjust the brightness of the black areas displayed on both sides of 4:3 images.

CONFIGURATION3 RESET

Reset all settings in the **CONFIGURATION3** menu to factory preset values.

ADVANCED OPTION menu

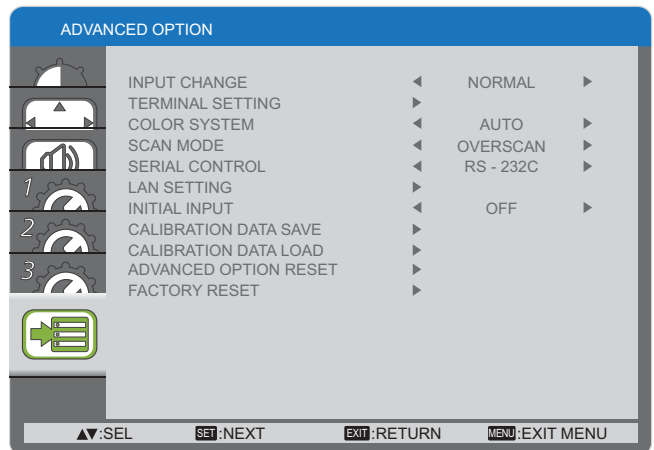

INPUT CHANGE

Select the time for input switching as **{NORMAL}** or **{QUICK}**.

NOTE: The selection **{QUICK}** may cause a slight noise.

TERMINAL SETTING

Select the mode to display the HDMI or DVI signal according to their signal format depending on their source device.

- **{DVI MODE}**: Used for DVI-D signal.
 - Select **{DVI-PC}** when the source device is a PC.
 - Select **{DVI-HD}** when the source device is a video device.
- **{HDMI SIGNAL}**: Used for HDMI signal.
 - Select **{LIMITED}** when displaying the signal that uses 16 to 235 levels of 256 levels for each R, G, and B.
 - Select **{FULL}** when displaying the signal that uses all 256 levels (from level 0 to 255).

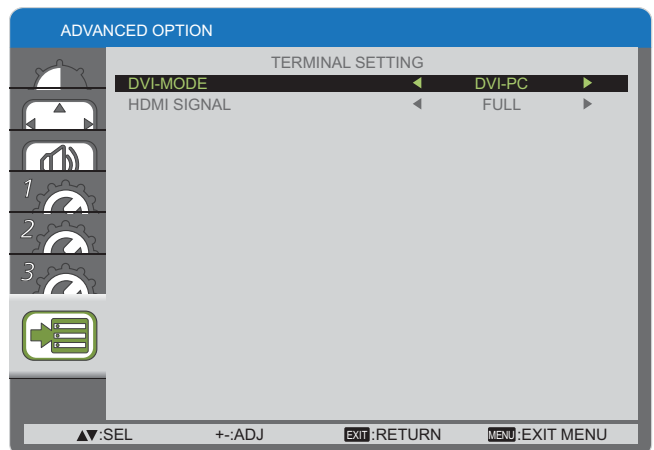

COLOR SYSTEM

Selects the Color System depends on your input video format.

The options are: **{AUTO}** / **{NTSC}** / **{PAL}** / **{SECAM}** / **{4.43NTSC}** / **{PAL-60}**.

NOTE: This item is functional for **VIDEO** input only.

SCAN MODE

Change this Display's area of the image.

- **{OVERSCAN}** - Display about 95% of the original size of the image. The rest of the areas surrounding the image will be cut off.
- **{UNDERSCAN}** - Display the image in its original size.

NOTE: This item is functional for **HDMI-Video** timing input only.

SERIAL CONTROL

Select the network control port.

The options are: **{RS-232C}** / **{LAN}**.

NOTE: If **{LAN}** is selected, then **{RS-232C}** will not be activated, even if a cable is attached, and vice versa.

LAN SETTING

Assign **{IP ADDRESS}**, **{SUBNET MASK}**, and **{DEFAULT GATEWAY}** for this Display.

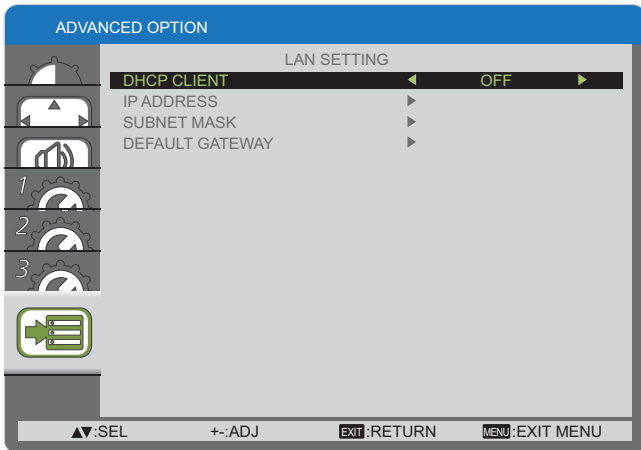

- DHCP - Choose to enable or disable the DHCP function. If enabled, this Display will be assigned IP address, Subnet mask and Default gateway automatically. If disabled, you will be prompted to enter the following value manually.

INITIAL INPUT

Select the input source you want this Display to initiate each time after turning power on.

CALIBRATION DATA SAVE

Save the data of color calibration executed and adjusted by user at any timing.

CALIBRATION DATA LOAD

By read this data, PD will get back to state at the timing when user executed color calibration and adjusted.

Note: The data that saved and loaded by CALIBRATION DATA SAVE and LOAD, are below items.

- The adjustment data of white balance for each "COLOR TEMPERATURE" (3000K to 10000K, and NATIVE, USER)
- "BRIGHTNESS" data when picture mode is in STANDARD mode
- GAMMA data for each GAMMA curve.

ADVANCED OPTION RESET

Reset all settings in the **ADVANCED OPTION** menu to factory preset values.

1. Press **[SET]** button to enter the submenu.
2. Press **[▲]** or **[▼]** button to select **{YES}**, and then press **[SET]** button to do the reset.

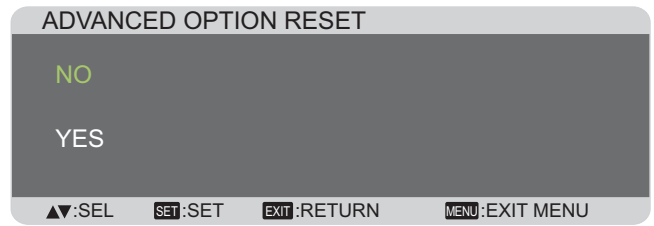

FACTORY RESET

Reset all the settings in the OSD menus of **{PICTURE}**, **{SCREEN}**, **{AUDIO}**, **{CONFIGURATION1}**, **{CONFIGURATION2}**, **{CONFIGURATION3}**, and **{ADVANCED OPTION}** to factory preset values.

1. Press **[SET]** button to enter the submenu.
2. Press **[▲]** or **[▼]** button to select **{YES}**, and then press **[SET]** button to do the reset.



Input Mode

PC Resolution:

Standard Resolution	Active Resolution		Refresh Rate	Dot Clock	Aspect Ratio	Stand for Mode
	H Pixels	V Lines				
VGA	640	480	60 Hz	25.175 MHz	4:3	Video Graphic Array
		480	72 Hz	31.5 MHz		
		480	75 Hz	31.5 MHz		
WVGA	720	400	70 Hz	33.75 MHz	16:9	Wide Video Graphic Array
SVGA	800	600	60 Hz	40 MHz	4:3	Super VGA
		600	75 Hz	49.5 MHz		
XGA	1024	768	60 Hz	65 MHz	4:3	Extended Graphic Array
		768	75 Hz	78.75 MHz		
WXGA	1280	768	60 Hz	79.5 MHz	5:3	Wide XGA
WXGA	1280	800	60 Hz	79.5 MHz	16:10	Wide XGA
SXGA	1280	960	60 Hz	108 MHz	4:3	Super XGA
SXGA	1280	1024	60 Hz	108 MHz	5:4	Super XGA
WXGA	1360	768	60 Hz	85.5 MHz	16:9	Wide XGA
WXGA	1366	768	60 Hz	85.5 MHz	16:9	Wide XGA
UXGA	1600	1200	60 Hz	162 MHz	4:3	Ultra XGA
HD1080	1920	1080	60 Hz	148.5 MHz	16:9	HD1080

SDTV Resolution:

Standard Resolution	Active Resolution		Refresh Rate	Dot Clock	Aspect Ratio	Stand for Mode
	H Pixels	V Lines				
480i	720	480	29.97 Hz	13.5 MHz	4:3	Modified NTSC
480p			59.94 Hz	27 MHz		Standard
576i	720	480	25 Hz	13.5 MHz	4:3	Modified PAL
576p			50 Hz	27 MHz		Standard

HDTV Resolution:

Standard Resolution	Active Resolution		Refresh Rate	Dot Clock	Aspect Ratio	Stand for Mode
	H Pixels	V Lines				
720p	1280	720	50 Hz	74.25 MHz	16:9	Normally DVB Mode
			60 Hz			
1080i	1920	1080	25 Hz	74.25 MHz	16:9	Normally ATSC Mode
			30 Hz			
1080p	1920	1080	50 Hz	148.5 MHz	16:9	Normally ATSC Mode
			60 Hz			

- The PC text quality is optimum in HD 1080 mode (1920 × 1080, 60 Hz).
- Your PC display screen might appear different depending on the manufacture (and your particular version of Windows).
- Check your PC instruction book for information about connecting your PC to a monitor.
- If a vertical and horizontal frequency-select mode exists, select 60 Hz (vertical) and 31.5 KHz (horizontal). In some cases, abnormal signals (such as stripes) might appear on the screen when the PC power is turned off (or if the PC is disconnected). If so, press the **[INPUT]** button to enter the video mode. Also, make sure that the PC is connected.
- When horizontal synchronous signals seem irregular in RGB mode, check PC power saving mode or cable connections.
- The display settings table complies to the IBM/VESA standards, and based on the analog input.
- The DVI support mode is regarded as same to the PC support mode.
- The best timing for the vertical frequency to each mode is 60 Hz.

Cleaning and Troubleshooting

Cleaning

Caution When Using this Display

- Do not bring your hands, face or objects close to the ventilation holes of this Display. The top of this Display is usually very hot due to the high temperature of exhaust air being released through the ventilation holes. Burns or personal injuries may occur if any body parts are brought too close. Placing any object near the top of this Display could also result in heat related damage to the object as well as the Display itself.
- Be sure to disconnect all cables before moving this Display. Moving this Display with its cables attached may damage the cables and thus cause fire or electric shock.
- Disconnect the power plug from the wall outlet as a safety precaution before carrying out any type of cleaning or maintenance procedure.

Front Panel Cleaning Instructions

- The front of this Display has been specially treated. Wipe the surface gently using only a cleaning cloth or a soft, lint-free cloth.
- If the surface becomes dirty, soak a soft, lint-free cloth in a mild detergent solution. Wring the cloth to remove excess liquid. Wipe the surface of this Display to remove dirt. Then use a dry cloth of the same type to dry.
- Do not scratch or hit the surface of the panel with fingers or hard objects of any kind.
- Do not use volatile substances such as insect sprays, solvents and thinners.









Cabinet Cleaning Instructions

- If the cabinet becomes dirty, wipe the cabinet with a soft, dry cloth.
- If the cabinet is extremely dirty, soak a lint-free cloth in a mild detergent solution. Wring the cloth to remove as much moisture as possible. Wipe the cabinet. Use another dry cloth to wipe over until the surface is dry.
- Do not allow any water or detergent to come into contact with the surface of this Display. If water or moisture gets inside the unit, operating problems, electrical and shock hazards may result.
- Do not scratch or hit the cabinet with fingers or hard objects of any kind.
- Do not use volatile substances such as insect sprays, solvents and thinners on the cabinet.
- Do not place anything made from rubber or PVC near the cabinet for any extended periods of time.

Troubleshooting

Before you call for service, determine the symptoms and make a few simple checks as shown below.

Symptom	Possible Cause	Remedy
No picture is displayed	<ol style="list-style-type: none"> 1. The power cord is disconnected. 2. The main power switch on the back of this Display is not switched on. 3. The selected input has no connection. 4. The display is in standby mode. 	<ol style="list-style-type: none"> 1. Plug in the power cord. 2. Make sure the power switch is switched on. 3. Connect a signal connection to this Display.
Interference displayed on this Display or audible noise is heard	Caused by surrounding electrical appliances or fluorescent lights.	Move this Display to another location to see if the interference is reduced.
Color is abnormal	The signal cable is not connected properly.	Make sure that the signal cable is attached firmly to the back of this Display.
Picture is distorted with abnormal patterns	<ol style="list-style-type: none"> 1. The signal cable is not connected properly. 2. The input signal is beyond the capabilities of this Display. 	<ol style="list-style-type: none"> 1. Make sure that the signal cable is attached firmly. 2. Check the video signal source to see if it is beyond the range of this Display. Please verify its specifications with this Display's specification section.
After changing input source or signal, Picture is not displayed correctly.	Picture signal might be not received correctly.	At once, select other input source, then back to intended input source.
Display image doesn't fill up the full size of the screen	The zoom mode is not correctly set.	Use the Zoom mode or Custom zoom function in the Screen menu to fine tune display geometry and time frequency parameter.
Can hear sound, but no picture	Improperly connected source signal cable.	Make sure that both video inputs and sound inputs are correctly connected.
Can see picture but no sound is heard	<ol style="list-style-type: none"> 1. Improperly connected source signal cable. 2. Volume is turned all the way down. 3. [MUTE] is turned on. 4. No external speaker connected. 	<ol style="list-style-type: none"> 1. Make sure that both video inputs and sound inputs are correctly connected. 2. Press [+] or [-] button to hear sound. 3. Switch MUTE off by using the [MUTE] button. 4. Connect external speakers and adjust the volume to a suitable level.
Some picture elements do not light up	Some pixels of this Display may not turn on.	This display is manufactured using an extremely high level of precision technology: however, sometimes some pixels of this Display may not display. This is not a malfunction.
After-Images can still be seen on this Display after this Display is powered off. (Examples of still pictures include logos, video games, computer images, and images displayed in 4:3 normal mode)	A still picture is displayed for an over extended period of time.	Do not allow a still image to be displayed for an extended period of time as this can cause a permanent after-image to remain on this Display.

Symptoms		Checks
Picture	Sound	
 Interference	 Noisy Sound	Electrical Appliances Cars / Motorcycles Fluorescent light
 Normal Picture	 No Sound	Volume (Check whether the mute function has been activated on the remote control.)
 No Picture	 No Sound	Not plugged into AC outlet Not switched on PICTURE and BRIGHTNESS/Volume setting (Check by pressing the power switch or stand-by button on the remote control.)
 No Picture	 Normal Sound	If a signal with a non-applicable color system format, or frequency is input, only the input terminal indication is displayed.
No remote control operations can be performed.		Check whether the batteries have discharged completely and, if they have not, whether they were inserted properly. Check whether the remote control sensor is exposed to an outdoor light or a strong fluorescent light. Check whether the remote control designed specifically for use with the unit is being used. (The unit cannot be operated by any other remote control.)
A cracking sound is sometimes heard from the unit.		If there is nothing wrong with the picture or sound, this is the sound of the cabinet undergoing very slight contractions in response to changes in the room temperature. There are no adverse effects on the performance or other aspects.
The top or bottom of the picture on the screen is cut off when I use the zoom function.		Adjust the position of the picture on the screen.
Areas at the top and bottom of the screen where the image is missing appear when I use the zoom function.		When using a video software program (such as a cinema size program) with a screen wider than one in the 16:9 mode, blank areas separate from the images are formed at the top and bottom of the screen.
I can hear sounds coming from inside the unit.		When the power is turned on, a sound of this Display panel being driven may be heard: This is normal and not indicative of malfunctioning.
Parts of the unit become hot.		Even when the temperature of parts of the front, top and rear panels has risen, these temperature rises will not pose any problems in terms of performance or quality.
Power automatically turns off unexpectedly.		Check the settings of "OFF TIMER" or "POWER SAVE". Any of them may be set to enable (see page 25, 27).
This LCD Display uses special image processing. Hence a slight time lag may occur between image and audio, depending on the type of input signal. However, this is not a malfunction.		

Symptoms	Checks
It takes a while for the picture to appear.	The unit digitally processes the various signals in order to reproduce esthetically pleasing images. As such, it sometimes takes a few moments for the picture to appear when the power has been turned on, when the input has been switched.
The edges of the images flicker.	Due to the characteristics of the system used to drive the panel, the edges may appear to flicker in the fast-moving parts of the images: This is normal and not indicative of malfunctioning.
There may be red spots, blue spots, green spots and black spots on the screen.	This is a characteristic of liquid crystal panels and is not a problem. The liquid crystal panel is built with very high precision technology giving you fine picture details. Occasionally, a few non-active pixels may appear on the screen as fixed points of red, blue, green, or black. Please note this does not affect the performance of your LCD.
 <p>Image retention appears</p>	Image retention may occur. If you display a still picture for an extended period, the image might remain on the screen. However, it will disappear after a while. This is not considered as malfunction.

Technical Specifications

Display:

Item	Specifications
Screen Size	55" LCD
Active Screen Size	54.64 inches (1387.80 mm) diagonal
Aspect Ratio	16:9
Number of pixels	1920 (H) × 1080 (V)
Pixel Pitch	0.630 (H) × 0.630 (V) [mm], 0.0248 (H) × 0.0248 (V) [inch]
Displayable Colors	10 Bit (D), 1.06 Billion colors
Brightness (typical)	500 cd/m ²
Contrast Ratio (typical)	1400:1
Viewing Angle	Up 89 / Down 89 / Left 89 / Right 89 (typ) @ CR > 10

In/Out Terminals:

Item	Specifications
Speaker Output	External Speaker 10 W + 10 W (8 Ω)
Audio Input	RCA Jack × 2 3.5 mm Stereo × 1 0.5 V [rms] (Normal) / 2 Channel (L+R)
Audio Output	RCA Jack × 2 0.5 V [rms] (Normal) / 2 Channel (L+R)
RS232C	D-Sub Jack × 2 (9 pin) TXD + RXD (1:1)
RJ-45	RJ-45 Jack × 1 (8 pin) 10/100 LAN Port
HDMI Input	HDMI Jack × 1 (Type A) (18 pin) Video : 480i, 480p, 720p, 1080i, 1080p Audio: 32 kHz, 44.1 kHz, 48 kHz / 2 Channel (L+R) Supports LPCM only
DVI-D Input	DVI-D jack MAX: 1920 × 1080 / 60 Hz (WUXGA)
DVI-I Output	DVI-I jack Pass-through from DVI-D Input
PC Input	D-Sub Jack × 1 (15 pin) Analog RGB: 0.7 V [p-p] (75 Ω), H/CS/V: TTL (2.2 kΩ), SOG: 1 V [p-p] (75 Ω) MAX: 1920 × 1080 / 60 Hz (WUXGA)
Component Input	BNC Jack × 3 Y: 1 V [p-p] (75 Ω), Pb: 0.7 V [p-p] (75Ω), Pr: 0.7 V [p-p] (75 Ω) MAX: 480i, 576i, 480p, 576p, 720p, 1080i, 1080p
Composite Input	BNC Jack × 1 (shared with Component-Y) Video: 1 V [p-p] (75 Ω) MAX: 480i, 576i

General:

Item	Specifications
Power Supply	220 - 240 V AC, 50/60 Hz. TAIWAN: 110V AC, 60Hz (for Taiwan only)
Power Consumption (Max)	220 W
Power Consumption (Standby)	< 0.5 W
Power Consumption (Saving)	< 2 W
Dimensions [W × H × D]	1215.5 × 686.3 × 121.2 mm, 47.85" × 27.02" × 4.77"
Weight	36 kg, 79.3 lbs

Operating Condition:

Item	Specifications
Temperature	0 ~ 40 °C, 32 ~ 104 °F
Humidity	10 ~ 90 % RH (No condensation)
Altitude	0 ~ 2,000 m

Information for Users on Collection and Disposal of Old Equipment and used Batteries



These symbols on the products, packaging, and/or accompanying documents mean that used electrical and electronic products and batteries should not be mixed with general household waste.

For proper treatment, recovery and recycling of old products and used batteries, please take them to applicable collection points, in accordance with your national legislation and the Directives 2002/96/EC and 2006/66/EC.



By disposing of these products and batteries correctly, you will help to save valuable resources and prevent any potential negative effects on human health and the environment which could otherwise arise from inappropriate waste handling.

For more information about collection and recycling of old products and batteries, please contact your local municipality, your waste disposal service or the point of sale where you purchased the items.

Penalties may be applicable for incorrect disposal of this waste, in accordance with national legislation.



For business users in the European Union

If you wish to discard electrical and electronic equipment, please contact your dealer or supplier for further information.

[Information on Disposal in other Countries outside the European Union]

These symbols are only valid in the European Union. If you wish to discard these items, please contact your local authorities or dealer and ask for the correct method of disposal.



Note for the battery symbol (bottom two symbol examples):

This symbol might be used in combination with a chemical symbol. In this case it complies with the requirement set by the Directive for the chemical involved.

Cd

Customer's Record

The model number and serial number of this product can be found on its rear panel. You should note this serial number in the space provided below and retain this book, plus your purchase receipt, as a permanent record of your purchase to aid in identification in the event of theft or loss, and for Warranty Service purposes.

Model Number _____

Serial Number _____

Panasonic Corporation

Web Site: <http://panasonic.net>
© Panasonic Corporation 2013

Pursuant to the directive 2004/108/EC, article 9(2)

Panasonic Testing Centre
Panasonic Service Europe, a division of Panasonic Marketing Europe GmbH
Winsbergring 15, 22525 Hamburg, F.R. Germany