

Model No.

TH-50LFC70U TH-50LFC70W  
TH-65LFC70U TH-65LFC70W  
TH-80LFC70U TH-80LFC70W  
TH-50LFC70E  
TH-65LFC70E  
TH-80LFC70E

## Operating Instructions Display Operations FULL HD LCD Display (for business use)



# HDMI

**English**

Please read these instructions before operating your set and retain them for future reference.

# Dear Panasonic Customer

Welcome to the Panasonic family of customers. We hope that you will have many years of enjoyment from your new LCD Display.

To obtain maximum benefit from your set, please read these Instructions before making any adjustments, and retain them for future reference.

Retain your purchase receipt also, and note down the model number and serial number of your set in the space provided on the rear cover of these instructions.

Visit our Panasonic Web Site <http://panasonic.net>

## Table of Contents

### Before use

- Illustrations and screens in this Operating Instructions are images for illustration purposes, and may be different from the actual ones.
- Descriptive illustrations in this Operating Instructions are created mainly based on the 50 inch model.

<b>Important Safety Instructions</b> .....	1	<b>Sound Adjustment</b> .....	43
<b>FCC STATEMENT</b> .....	2	SDI Sound Output .....	43
<b>Important Safety Notice</b> .....	3	<b>Setup menu</b> .....	44
<b>Safety Precautions</b> .....	4	<b>Day/Time Settings / On/Off Timer Settings</b> .....	45
<b>Accessories</b> .....	7	Day/Time Settings .....	45
Accessories Supply .....	7	On/Off Timer Settings.....	45
Contents in the CD-ROM .....	7	<b>MULTI PIP Settings</b> .....	46
Remote Control Batteries .....	8	<b>Screensaver (For preventing image retention)</b> ....	47
<b>Connections</b> .....	9	Setup of Screensaver Time .....	48
AC cord connection and fixing, cable fixing.....	9	<b>ECO Mode settings</b> .....	49
Speaker connection.....	11	<b>Customizing the Input labels</b> .....	50
Video equipment connection .....	11	<b>Function Button Settings</b> .....	51
VIDEO and COMPONENT / RGB IN connection....	13	<b>Memory Viewer Settings</b> .....	52
HDMI connection.....	13	<b>Monitor Out</b> .....	52
DVI-D IN connection.....	14	<b>No activity power off</b> .....	53
PC Input Terminals connection.....	15	<b>Menu Display Duration / OSD Brightness</b> .....	53
SERIAL Terminals connection .....	16	<b>OSD Language</b> .....	53
PC OUT connection.....	17	<b>Setup for Input Signals</b> .....	54
Example connection using the DIGITAL LINK		Component / RGB-in select.....	54
Terminal.....	18	YUV / RGB-in select.....	54
<b>Power On / Off</b> .....	19	Signal menu .....	55
<b>Selecting the input signal</b> .....	21	<b>Options Adjustments</b> .....	58
<b>Basic Controls</b> .....	22	Weekly Command Timer .....	61
<b>ASPECT Controls</b> .....	25	Audio input select .....	63
<b>Digital Zoom</b> .....	26	Input Search .....	64
<b>MULTI PIP</b> .....	27	RS-232C/LAN Information Timing .....	65
<b>Memory Viewer Function</b> .....	28	<b>Troubleshooting</b> .....	66
<b>Using Miracast(TM)</b> .....	33	When using Miracast.....	68
<b>On-Screen Menu Displays</b> .....	34	<b>List of Aspect Modes</b> .....	69
<b>Adjusting Pos./Size</b> .....	35	<b>Applicable Input Signals</b> .....	71
<b>Picture Adjustments</b> .....	38	<b>Shipping condition</b> .....	72
Advanced settings .....	39	<b>Command list of Weekly Command Timer</b> .....	73
<b>Picture Profiles</b> .....	40	<b>Specifications</b> .....	74
Saving profiles .....	41	<b>Software License</b> .....	77
Loading profiles .....	42		
Editing profiles.....	42		



The lightning flash with arrow-head within a triangle is intended to tell the user that parts inside the product are a risk of electric shock to persons.



The exclamation point within a triangle is intended to tell the user that important operating and servicing instructions are in the papers with the appliance.

**WARNING :** To prevent damage which may result in fire or shock hazard, do not expose this apparatus to rain or moisture.  
Do not place containers with water (flower vase, cups, cosmetics, etc.) above the set.  
(including on shelves above, etc.)

**WARNING :** 1) To prevent electric shock, do not remove cover. No user serviceable parts inside. Refer servicing to qualified service personnel.  
2) Do not remove the grounding pin on the power plug. This apparatus is equipped with a three pin grounding-type power plug. This plug will only fit a grounding-type power outlet. This is a safety feature. If you are unable to insert the plug into the outlet, contact an electrician.  
Do not defeat the purpose of the grounding plug.

## Important Safety Instructions

- 1) Read these instructions.
- 2) Keep these instructions.
- 3) Heed all warnings.
- 4) Follow all instructions.
- 5) Do not use this apparatus near water.
- 6) Clean only with dry cloth.
- 7) Do not block any ventilation openings. Install in accordance with the manufacturer's instructions.
- 8) Do not install near any heat sources such as radiators, heat registers, stoves, or other apparatus (including amplifiers) that produce heat.
- 9) Do not defeat the safety purpose of the polarized or grounding-type plug. A polarized plug has two blades with one wider than the other. A grounding type plug has two blades and a third grounding prong. The wide blade or the third prong are provided for your safety. If the provided plug does not fit into your outlet, consult an electrician for replacement of the obsolete outlet.
- 10) Protect the power cord from being walked on or pinched particularly at plugs, convenience receptacles, and the point where they exit from the apparatus.
- 11) Only use attachments / accessories specified by the manufacturer.
- 12) Use only with the cart, stand, tripod, bracket, or table specified by the manufacturer, or sold with the apparatus. When a cart is used, use caution when moving the cart / apparatus combination to avoid injury from tip-over.
- 13) Unplug this apparatus during lightning storms or when unused for long periods of time.
- 14) Refer all servicing to qualified service personnel. Servicing is required when the apparatus has been damaged in any way, such as power-supply cord or plug is damaged, liquid has been spilled or objects have fallen into the apparatus, the apparatus has been exposed to rain or moisture, does not operate normally, or has been dropped.
- 15) To prevent electric shock, ensure the grounding pin on the AC cord power plug is securely connected.



# FCC STATEMENT

This equipment has been tested and found to comply with the limits for a Class B digital device, pursuant to Part 15 of the FCC Rules. These limits are designed to provide reasonable protection against harmful interference in a residential installation. This equipment generates, uses and can radiate radio frequency energy and, if not installed and used in accordance with the instructions, may cause harmful interference to radio communications. However, there is no guarantee that interference will not occur in a particular installation. If this equipment does cause harmful interference to radio or television reception, which can be determined by turning the equipment off and on, the user is encouraged to try to correct the interference by one or more of the following measures:

- Reorient or relocate the receiving antenna.
- Increase the separation between the equipment and receiver.
- Connect the equipment into an outlet on a circuit different from that to which the receiver is connected.
- Consult the dealer or an experienced technician for help.

This device complies with Part 15 of the FCC Rules. Operation is subject to the following two conditions: (1) This device may not cause harmful interference, and (2) this device must accept any interference received, including interference that may cause undesired operation.

## **FCC CAUTION:**

**To assure continued compliance, follow the attached installation instructions and use only shielded interface cables when connecting to computer or peripheral devices. Some recommended user provided interface cables may require usage of the attached ferrite core kit(s), refer to interface cable connection instructions for details. Any changes or modifications not expressly approved by Panasonic Corp. of North America could void the user's authority to operate this device.**

### FCC Declaration of Conformity

Model No. TH-50LFC70U, TH-65LFC70U, TH-80LFC70U

Responsible Party: Panasonic Corporation of North America  
Two Riverfront Plaza, Newark, New Jersey 07102-5490  
Contact Source: Panasonic System Communications Company of North America  
1-877-655-2357

## **CANADIAN NOTICE:**

This Class B digital apparatus complies with Canadian ICES-003.

## **Note:**

Image retention may occur. If you display a still picture for an extended period, the image might remain on the screen. However, it will disappear after a while.

## **Trademark Credits**

- VGA is a trademark of International Business Machines Corporation.
- Microsoft®, Windows®, Windows Vista®, and Internet Explorer® are the registered trademarks or trademarks of Microsoft Corporation in the United States and/or other countries.
- Macintosh, Mac, Mac OS, OS X and Safari are the trademarks of Apple Inc. registered in the United States and other countries.
- SVGA, XGA, SXGA and UXGA are registered trademarks of the Video Electronics Standard Association. Even if no special notation has been made of company or product trademarks, these trademarks have been fully respected.
- HDMI, the HDMI Logo, and High-Definition Multimedia Interface are trademarks or registered trademarks of HDMI Licensing LLC in the United States and other countries.
- RoomView, Crestron RoomView and Fusion RV are registered trademarks of Crestron Electronics, Inc, and Crestron Connected is the trademark of Crestron Electronics, Inc.
- Miracast is a trademark of Wi-Fi Alliance.
- Android is a registered trademark of Google Inc.
- iPad, iPhone, and iPod touch are trademarks of Apple Inc., registered in the U.S. and other countries.

# Important Safety Notice

## WARNING

- 1) To prevent damage which may result in fire or shock hazard, do not expose this appliance to dripping or splashing.  
Do not place containers with water (flower vase, cups, cosmetics, etc.) above the set. (including on shelves above, etc.)  
No naked flame sources, such as lighted candles, should be placed on / above the set.
- 2) To prevent electric shock, do not remove cover. No user serviceable parts inside. Refer servicing to qualified service personnel.
- 3) Do not remove the earthing pin on the power plug. This apparatus is equipped with a three pin earthing-type power plug. This plug will only fit an earthing-type power outlet. This is a safety feature. If you are unable to insert the plug into the outlet, contact an electrician.  
Do not defeat the purpose of the earthing plug.
- 4) To prevent electric shock, ensure the earthing pin on the AC cord power plug is securely connected.

## CAUTION

This appliance is intended for use in environments which are relatively free of electromagnetic fields. Using this appliance near sources of strong electromagnetic fields or where electrical noise may overlap with the input signals could cause the picture and sound to wobble or cause interference such as noise to appear. To avoid the possibility of harm to this appliance, keep it away from sources of strong electromagnetic fields.

## IMPORTANT INFORMATION

If a display is not positioned in a sufficiently stable location, it can be potentially hazardous due to falling. Many injuries, particularly to children, can be avoided by taking simple precautions such as:

- Using cabinets or stands recommended by the manufacturer of the display.
- Only using furniture that can safely support the display.
- Ensuring the display is not overhanging the edge of the supporting furniture.
- Not placing the display on tall furniture (for example, cupboards or bookcases) without anchoring both the furniture and the display to a suitable support.
- Not standing the displays on cloth or other materials placed between the display and supporting furniture.
- Educating children about the dangers of climbing on furniture to reach the display or its controls.

## IMPORTANT: THE MOULDED PLUG

FOR YOUR SAFETY, PLEASE READ THE FOLLOWING TEXT CAREFULLY.

This display is supplied with a moulded three pin mains plug for your safety and convenience. A 10 amp fuse is fitted in this plug. Shall the fuse need to be replaced, please ensure that the replacement fuse has a rating of 10 amps and that it is approved by ASTA or BSI to BS1362.

Check for the ASTA mark  or the BSI mark  on the body of the fuse.

If the plug contains a removable fuse cover, you must ensure that it is refitted when the fuse is replaced.

If you lose the fuse cover the plug must not be used until a replacement cover is obtained.

A replacement fuse cover can be purchased from your local Panasonic dealer.

Do not cut off the mains plug.

Do not use any other type of mains lead except the one supplied with this display.

The supplied mains lead and moulded plug are designed to be used with this display to avoid interference and for your safety.

If the socket outlet in your home is not suitable, get it changed by a qualified electrician.

If the plug or mains lead becomes damaged, purchase a replacement from an authorized dealer.

### **WARNING : — THIS DISPLAY MUST BE EARTHED.**

How to replace the fuse. Open the fuse compartment with a screwdriver and replace the fuse.

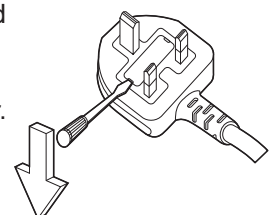

# Safety Precautions

## WARNING

### ■ Setup

**This LCD Display is for use only with the following optional accessories. Use with any other type of optional accessories may cause instability which could result in the possibility of injury.**

(All of the following accessories are manufactured by Panasonic Corporation.)

- Pedestal ..... TY-ST42P50 (for 50 inch model)\*,  
TY-ST65P20 (for 65 inch model and 80 inch model)
- Mobile stand for Display ..... TY-ST50PB2 (for 50 inch model),  
TY-ST65PB2 (for 65 inch model),  
TY-ST80LF70 (for 80 inch model)
- Mobile stand ..... TY-ST58PF20 (for 50 inch model)
- Wall-hanging bracket (vertical) ..... TY-WK42PV20 (for 50 inch model),  
TY-WK70PV50 (for 80 inch model)
- Wall-hanging bracket (angled) ..... TY-WK42PR20 (for 50 inch model),  
TY-WK65PR20 (for 65 inch model)
- Ceiling-hanging bracket ..... TY-CE42PS20 (for 50 inch model)
- BNC Dual Video Terminal Board ..... TY-FB9BD
- HD-SDI Terminal Board ..... TY-FB9HD
- HD-SDI Terminal Board with audio ..... TY-FB10HD
- Dual Link HD-SDI Terminal Board ..... TY-FB11DHD
- Dual HDMI Terminal Board ..... TY-FB10HMD
- DVI-D Terminal Board ..... TY-FB11DD
- Digital Interface Box ..... ET-YFB100G

**\*Precaution for use of TY-ST42P50 (for 50 inch model)**

Use a stand pole "for plasma display (long)" (part number: TBLA3679, TBLA3680).

We are not responsible for any product damage, etc. caused by use of the pedestal, wall-hanging bracket or ceiling-hanging bracket made by other companies, or by failures in the installation environment for the pedestal, wall-hanging bracket or ceiling-hanging bracket even during the warranty period.

Always be sure to ask a qualified technician to carry out set-up.

Small parts can present choking hazard if accidentally swallowed. Keep small parts away from young children. Discard unneeded small parts and other objects, including packaging materials and plastic bags/sheets to prevent them from being played with by young children, creating the potential risk of suffocation.

**Do not place the Display on sloped or unstable surfaces, and ensure that the Display does not hang over the edge of the base.**

- The Display may fall off or tip over.

**Do not place any objects on top of the Display.**

- If water is spilled onto the Display or foreign objects get inside it, a short-circuit may occur which could result in fire or electric shock. If any foreign objects get inside the Display, please consult your local Panasonic dealer.

**Transport only in upright position!**

- Transporting the unit with its display panel facing upright or downward may cause damage to the internal circuitry.

**Ventilation should not be impeded by covering the ventilation openings with items such as newspapers, table cloths and curtains.**

**For sufficient ventilation;**

**If using the pedestal (optional accessory), leave a space of 3 15/16" (10 cm) or more at the top, left and right, and 2 3/4" (7 cm) or more at the rear, and also keep the space between the bottom of the display and the floor surface.**

**If using some other setting-up method, follow the manual of it. (If there is no specific indication of installation dimension in the installation manual, leave a space of 3 15/16" (10 cm) or more at the top, bottom, left and right, and 2 3/4" (7 cm) or more at the rear.)**

**Cautions for Wall or ceiling Installation**

- Wall or ceiling installation should be performed by an installation professional. Installing the Display incorrectly may lead to an accident that results in death or serious injury. Use the specified accessories.
- If you terminate the use of the Display on the wall or ceiling, ask a professional to remove the Display as soon as possible.
- When mounting the Display on the wall, prevent the mounting screws and power cable from contacting metal objects inside the wall. An electric shock may occur if they contact metal objects inside the wall.

**Do not install the product to a place where the product is exposed to direct sunlight.**

- If the screen is exposed to direct sunlight, the liquid crystal panel may have adverse effect.

## ■ When using the LCD Display

The Display is designed to operate on 110 - 127 or 220 - 240 V AC, 50/60 Hz.

**Do not cover the ventilation holes.**

- Doing so may cause the Display to overheat, which can cause fire or damage to the Display.

**Do not stick any foreign objects into the Display.**

- Do not insert any metal or flammable objects into the ventilations holes or drop them onto the Display, as doing so can cause fire or electric shock.

**Do not remove the cover or modify it in any way.**

- High voltages which can cause severe electric shocks are present inside the Display. For any inspection, adjustment and repair work, please contact your local Panasonic dealer.

**Ensure that the mains plug is easily accessible.**

**An apparatus with CLASS I construction shall be connected to a mains socket outlet with a protective earthing connection.**

**Do not use any power supply cord other than that provided with this unit.**

- Doing so may cause fire or electric shocks.

**Securely insert the power supply plug as far as it will go.**

- If the plug is not fully inserted, heat may be generated which could cause fire. If the plug is damaged or the wall socket is loose, they shall not be used.

**Do not handle the power supply plug with wet hands.**

- Doing so may cause electric shocks.

**Do not do anything that may damage the power cable. When disconnecting the power cable, pull on the plug body, not the cable.**

- Do not damage the cable, make any modifications to it, place heavy objects on top of it, heat it, place it near any hot objects, twist it, bend it excessively or pull it. To do so may cause fire and electric shock. If the power cable is damaged, have it repaired at your local Panasonic dealer.

**Do not remove covers and NEVER modify the Display yourself**

- Do not remove the rear cover as live parts are accessible when it is removed. There are no user serviceable parts inside. (High-voltage components may cause serious electrical shock.)
- Have the Display checked, adjusted, or repaired at your local Panasonic dealer.

**If the Display is not going to be used for any prolonged length of time, unplug the power supply plug from the wall outlet.**

**To prevent the spread of fire, keep candles or other open flames away from this product at all times.**



## ■ If problems occur during use

**If a problem occurs (such as no picture or no sound), or if smoke or an abnormal odour starts to come out from the Display, immediately unplug the power supply plug from the wall outlet.**

- If you continue to use the Display in this condition, fire or electric shock could result. After checking that the smoke has stopped, contact your local Panasonic dealer so that the necessary repairs can be made. Repairing the Display yourself is extremely dangerous, and shall never be done.

**If water or foreign objects get inside the Display, if the Display is dropped, or if the cabinet becomes damages, disconnect the power supply plug immediately.**

- A short circuit may occur, which could cause fire. Contact your local Panasonic dealer for any repairs that need to be made.

## Safety Precautions

---

### CAUTION

#### ■ When using the LCD Display

**Do not bring your hands, face or objects close to the ventilation holes of the Display.**

- Heated air comes out from the ventilation holes at the top of Display will be hot. Do not bring your hands or face, or objects which cannot withstand heat, close to this port, otherwise burns or deformation could result.

**Be sure to disconnect all cables before moving the Display.**

- If the Display is moved while some of the cables are still connected, the cables may become damaged, and fire or electric shock could result.

**Disconnect the power supply plug from the wall socket as a safety precaution before carrying out any cleaning.**

- Electric shocks can result if this is not done.

**Clean the power cable regularly to prevent it becoming dusty.**

- If dust built up on the power cord plug, the resultant humidity can damage the insulation, which could result in fire. Pull the power cord plug out from the wall outlet and wipe the mains lead with a dry cloth.

**Do not burn or breakup batteries.**

- Batteries must not be exposed to excessive heat such as sunshine, fire or the like.

## Cleaning and maintenance

**The front of the display panel has been specially treated. Wipe the panel surface gently using only a cleaning cloth or a soft, lint-free cloth.**

- If the surface is particularly dirty, wipe with a soft, lint-free cloth which has been soaked in pure water or water in which neutral detergent has been diluted 100 times, and then wipe it evenly with a dry cloth of the same type until the surface is dry.
- Do not scratch or hit the surface of the panel with fingernails or other hard objects, otherwise the surface may become damaged. Furthermore, avoid contact with volatile substances such as insect sprays, solvents and thinner, otherwise the quality of the surface may be adversely affected.

**If the cabinet becomes dirty, wipe it with a soft, dry cloth.**

- If the cabinet is particularly dirty, soak the cloth in water to which a small amount of neutral detergent has been added and then wring the cloth dry. Use this cloth to wipe the cabinet, and then wipe it dry with a dry cloth.
- Do not allow any detergent to come into direct contact with the surface of the Display. If water droplets get inside the unit, operating problems may result.
- Avoid contact with volatile substances such as insect sprays, solvents and thinner, otherwise the quality of the cabinet surface may be adversely affected or the coating may peel off. Furthermore, do not leave it for long periods in contact with articles made from rubber or PVC.

**Usage of a chemical cloth**

- Do not use a chemical cloth for the panel surface.
- Follow the instructions for the chemical cloth to use it for the cabinet.



# Accessories

## Accessories Supply

Check that you have the accessories and items shown

Operating Instruction book

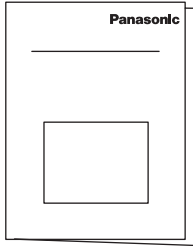

Software CD-ROM × 1

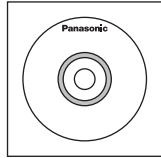

Remote Control Transmitter  
N2QAYB000691



Batteries for the Remote Control Transmitter  
(R6 (UM3) Size × 2)

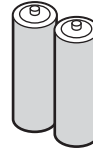

Clamper × 1  
TMME289

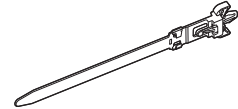

Ferrite core × 2  
J0KG00000014

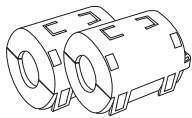

Use the Ferrite cores to comply with the EMC standard. (see page 14)

Cable tie × 2  
TMM17499



Power supply cord		
TH-50LFC70U, TH-65LFC70U, TH-80LFC70U	TH-50LFC70E, TH-65LFC70E, TH-80LFC70E	TH-50LFC70W, TH-65LFC70W, TH-80LFC70W

### Attention

Store small parts in an appropriate manner, and keep them away from young children.

## Contents in the CD-ROM

The contents below are included in the supplied CD-ROM.

<b>Instruction (PDF)</b>	Operating Instructions - Display Operations	
	Operating Instructions - Network Operations	
	Operating Instructions - Wireless Manager ME	
	Software license	GNU GENERAL PUBLIC LICENSE GNU LESSER GENERAL PUBLIC LICENSE
<b>Software</b>	Wireless Manager ME (Windows/Mac)	Allows the image on the computer screen to be sent wirelessly or via wired LAN. Switch the input to Panasonic APPLICATION before use. For more details, see the instruction manual of Wireless Manager ME.

# Remote Control Batteries

### Requires two R6 batteries.

1. Pull and hold the hook, then open the battery cover.
2. Insert batteries - note correct polarity (+ and -).
3. Replace the cover.

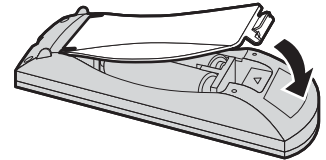
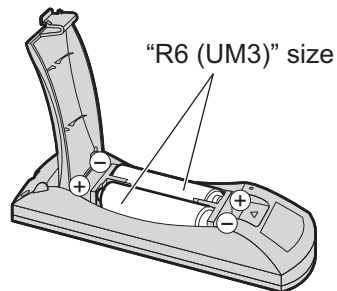
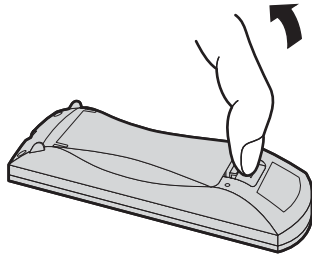

### Helpful Hint:

For frequent remote control users, replace old batteries with Alkaline batteries for longer life.

### ⚠ Precaution on battery use

Incorrect installation can cause battery leakage and corrosion that will damage the remote control transmitter. Disposal of batteries should be in an environment-friendly manner.

#### Observe the following precaution:

1. Batteries shall always be replaced as a pair. Always use new batteries when replacing the old set.
2. Do not combine a used battery with a new one.
3. Do not mix battery types (example: "Zinc Carbon" with "Alkaline").
4. Do not attempt to charge, short-circuit, disassemble, heat or burn used batteries.
5. Battery replacement is necessary when remote control acts sporadically or stops operating the Display set.
6. Do not burn or breakup batteries.
7. Batteries must not be exposed to excessive heat such as sunshine, fire or the like.

# Connections

## AC cord connection and fixing, cable fixing

For 50 inch and 65 inch models

### AC cord fixing

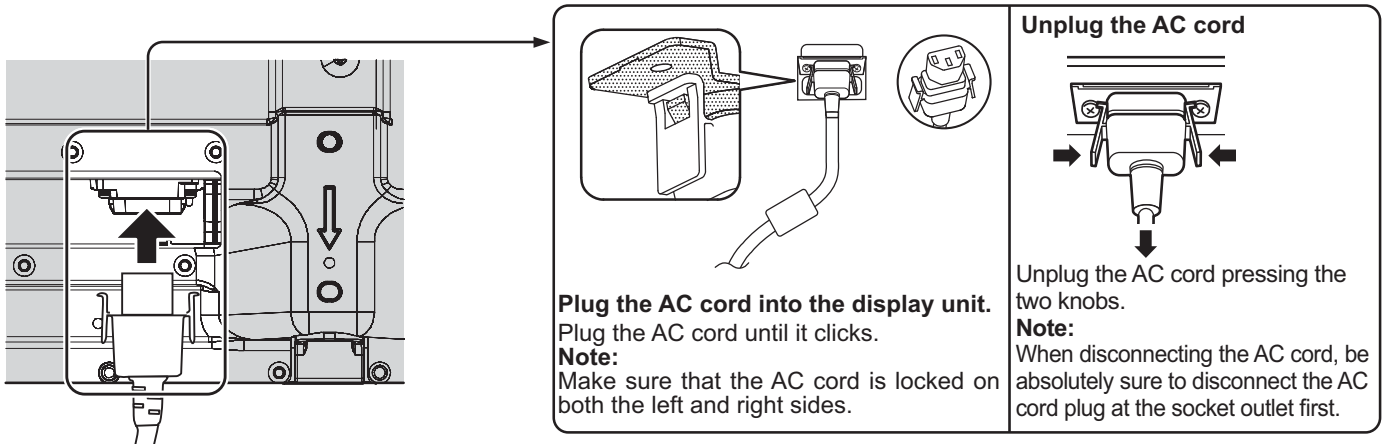

**Plug the AC cord into the display unit.**  
Plug the AC cord until it clicks.

**Note:**  
Make sure that the AC cord is locked on both the left and right sides.

**Unplug the AC cord**

Unplug the AC cord pressing the two knobs.

**Note:**  
When disconnecting the AC cord, be absolutely sure to disconnect the AC cord plug at the socket outlet first.

### When using the Wall-hanging bracket (vertical) (for 50 inch model)

**Note:**

When using the Wall-hanging bracket (vertical)(TY-WK42PV20), use the holes (A) and (B) to secure the cables. If the clammer is used on the hole (C), the cables may be caught by the wall-hanging bracket.

### 50 inch model

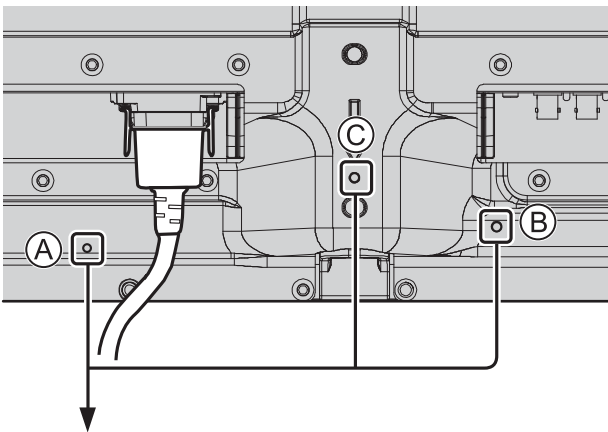

### 65 inch model

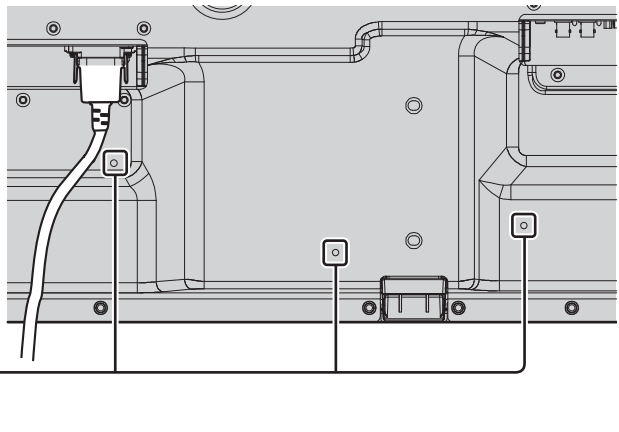

### Using the clammer

Secure any excess cables with clammer as required.

**Note:**

One clammer is supplied with this unit. In case of securing cables at three positions, please purchase it separately. If you need more clammers, purchase them from your dealer. (Available from the customer service)

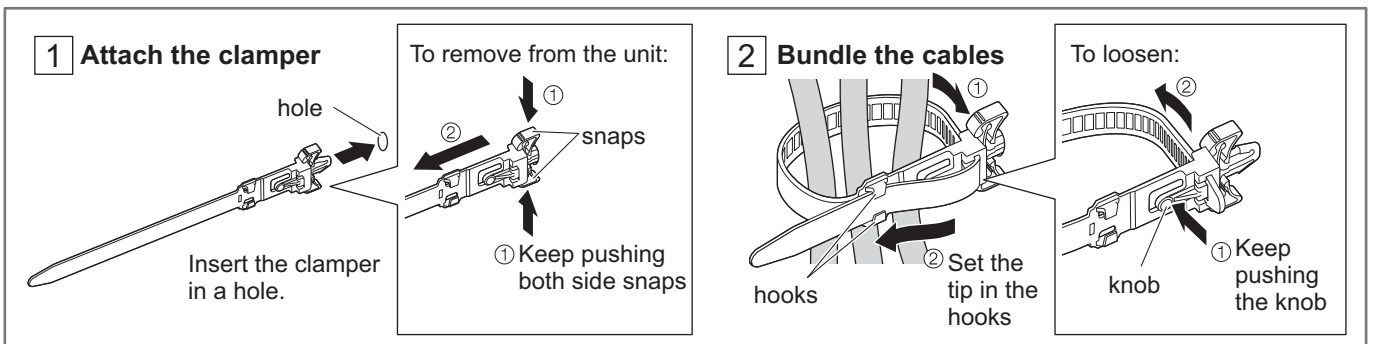

**1 Attach the clammer**

Insert the clammer in a hole.

To remove from the unit:

① Keep pushing both side snaps

**2 Bundle the cables**

hooks

Set the tip in the hooks

To loosen:

knob

① Keep pushing the knob

## For 80 inch model

### AC cord fixing

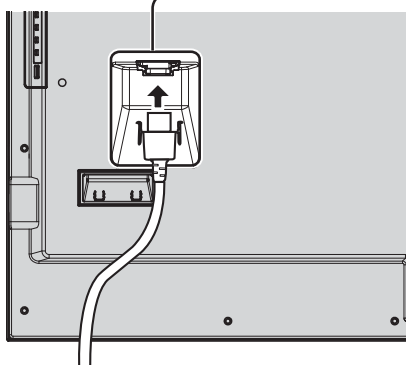

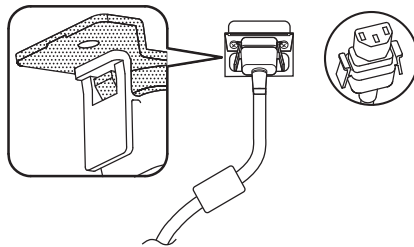
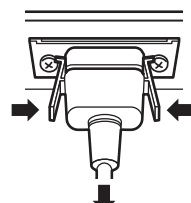
 <p><b>Plug the AC cord into the display unit.</b> Plug the AC cord until it clicks. <b>Note:</b> Make sure that the AC cord is locked on both the left and right sides.</p>	<p><b>Unplug the AC cord</b></p>  <p>Unplug the AC cord pressing the two knobs. <b>Note:</b> When disconnecting the AC cord, be absolutely sure to disconnect the AC cord plug at the socket outlet first.</p>
--	---

### Using the clamper

Secure any excess cables with clamper as required.

**Note:**

One clamper is supplied with this unit. In case of securing cables at four positions, please purchase it separately. If you need more clampers, purchase them from your dealer. (Available from the customer service)

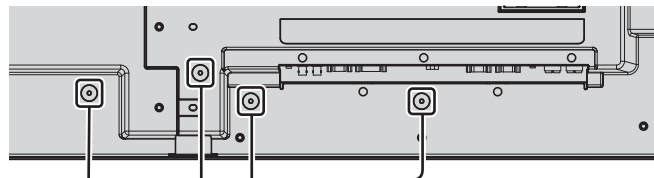

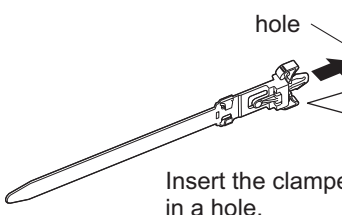
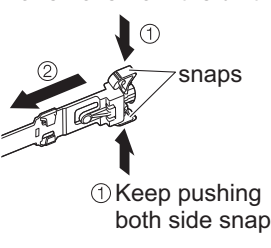
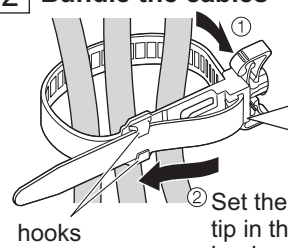
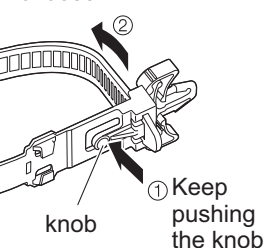
<p><b>1 Attach the clamper</b></p>  <p>hole</p> <p>Insert the clamper in a hole.</p>	<p>To remove from the unit:</p>  <p>snaps</p> <p>① Keep pushing both side snaps</p>	<p><b>2 Bundle the cables</b></p>  <p>hooks</p> <p>② Set the tip in the hooks</p>	<p>To loosen:</p>  <p>knob</p> <p>① Keep pushing the knob</p>
---	--	---	--

## Speaker connection

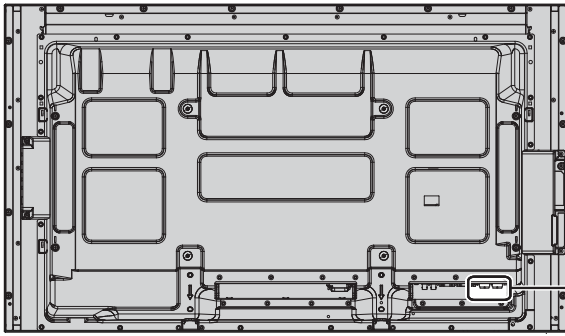

Please use 8 Ω/10 W speaker.

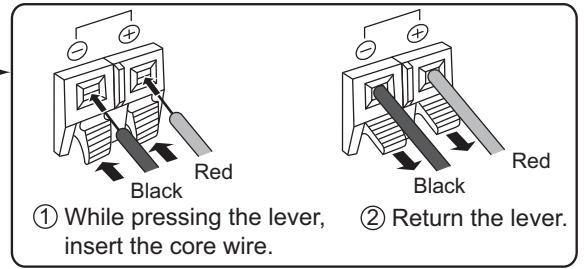

## Video equipment connection

For 50 inch and 65 inch models

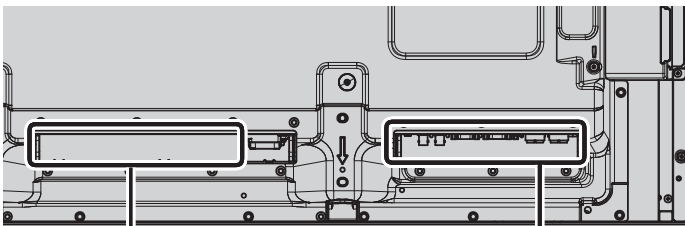

**SLOT:** Terminal board (optional accessories) insert slot (see page 4)

**Note:**

The right side slot is for terminal board with 2-slot width. The terminal board with 1-slot width does not function when installed in the right side slot.

**AV IN (VIDEO):** Composite Video Input Terminal (see page 13)

**COMPONENT/RGB IN:** Component/RGB Video Input Terminal (see page 13)

**PC OUT:**

Monitor Out Terminal. Video signals being reproduced on the display are output to another sub monitor as PC video signals. (see page 17)

**SERIAL:**

Serial Control Terminal. Control the Display by connecting to PC. (see page 16)

**AUDIO 2 IN:**

Audio input terminal shared with DVI-D IN and PC IN. (see page 14, 15)

**AUDIO 1 IN:**

Audio input terminal shared with VIDEO and COMPONENT/RGB IN. (see page 13)

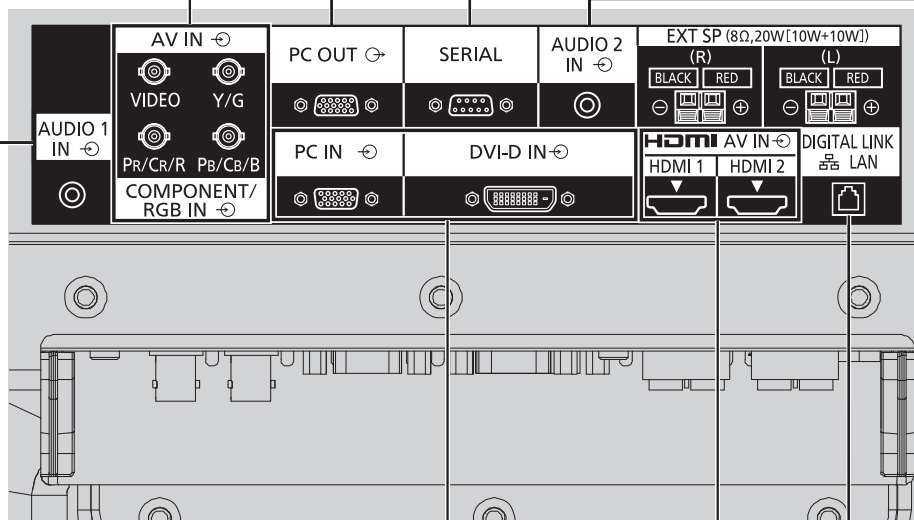

**PC IN:** PC Input Terminal

Connect to video terminal of PC or equipment with Y, PB(CB) and PR(CR) output (see page 15).

**DVI-D IN:** DVI-D Input Terminal (see page 14)

**AV IN (HDMI 1, HDMI 2):** HDMI Input Terminal (see page 13)

Connect to video equipment such as VCR or DVD player.

**LAN, DIGITAL LINK\***

Connect to a DIGITAL LINK input terminal network to control the Display. Alternatively, connect to a device that sends video and audio signals via the DIGITAL LINK terminal. (see page 18)

\* DIGITAL LINK is technology that enables signals such as audio and video to be transmitted using twisted pair cables. For details, see the Operating Instructions - "Network Operations".

# Connections

## For 80 inch model

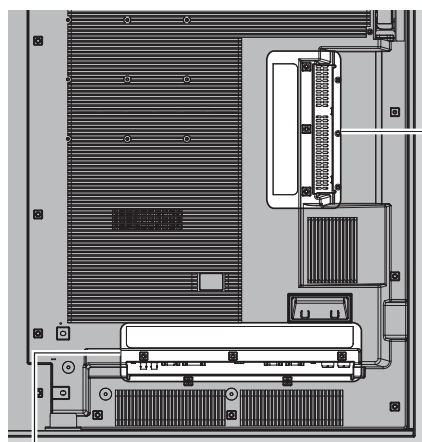

**SLOT:** Terminal board (optional accessories) insert slot (see page 4)

**Note:**

The upper side slot is for terminal board with 2-slot width. The terminal board with 1-slot width does not function when installed in the upper side slot.

**AV IN (VIDEO):** Composite Video Input Terminal (see page 13)  
**COMPONENT/RGB IN:** Component/RGB Video Input Terminal (see page 13)

**SERIAL:** Serial Control Terminal. Control the Display by connecting to PC. (see page 16)

**PC OUT:** Monitor Out Terminal. Video signals being reproduced on the display are output to another sub monitor as PC video signals. (see page 17)

**AUDIO 1 IN:** Audio input terminal shared with VIDEO and COMPONENT/RGB IN. (see page 13)

**AV IN (HDMI 1, HDMI 2):** HDMI Input Terminal (see page 13) Connect to video equipment such as VCR or DVD player.

**AUDIO 2 IN:** Audio input terminal shared with DVI-D IN and PC IN. (see page 14, 15)

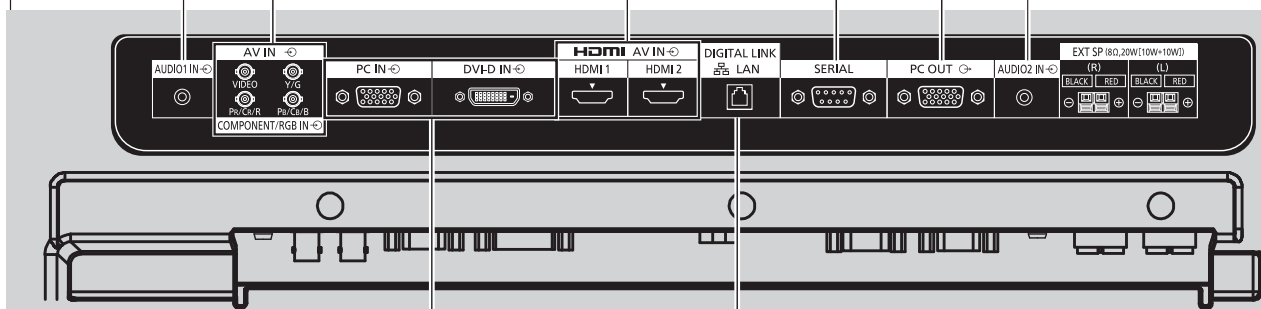

**PC IN:** PC Input Terminal Connect to video terminal of PC or equipment with Y, P<sub>B</sub>(C<sub>B</sub>) and P<sub>R</sub>(C<sub>R</sub>) output (see page 15).  
**DVI-D IN:** DVI-D Input Terminal (see page 14)

**LAN, DIGITAL LINK\*** Connect to a DIGITAL LINK input terminal network to control the Display. Alternatively, connect to a device that sends video and audio signals via the DIGITAL LINK terminal. (see page 18)

\* DIGITAL LINK is technology that enables signals such as audio and video to be transmitted using twisted pair cables. For details, see the Operating Instructions - "Network Operations".

# VIDEO and COMPONENT / RGB IN connection

**Note:**

Additional equipment, cables and adapter plugs shown are not supplied with this set.

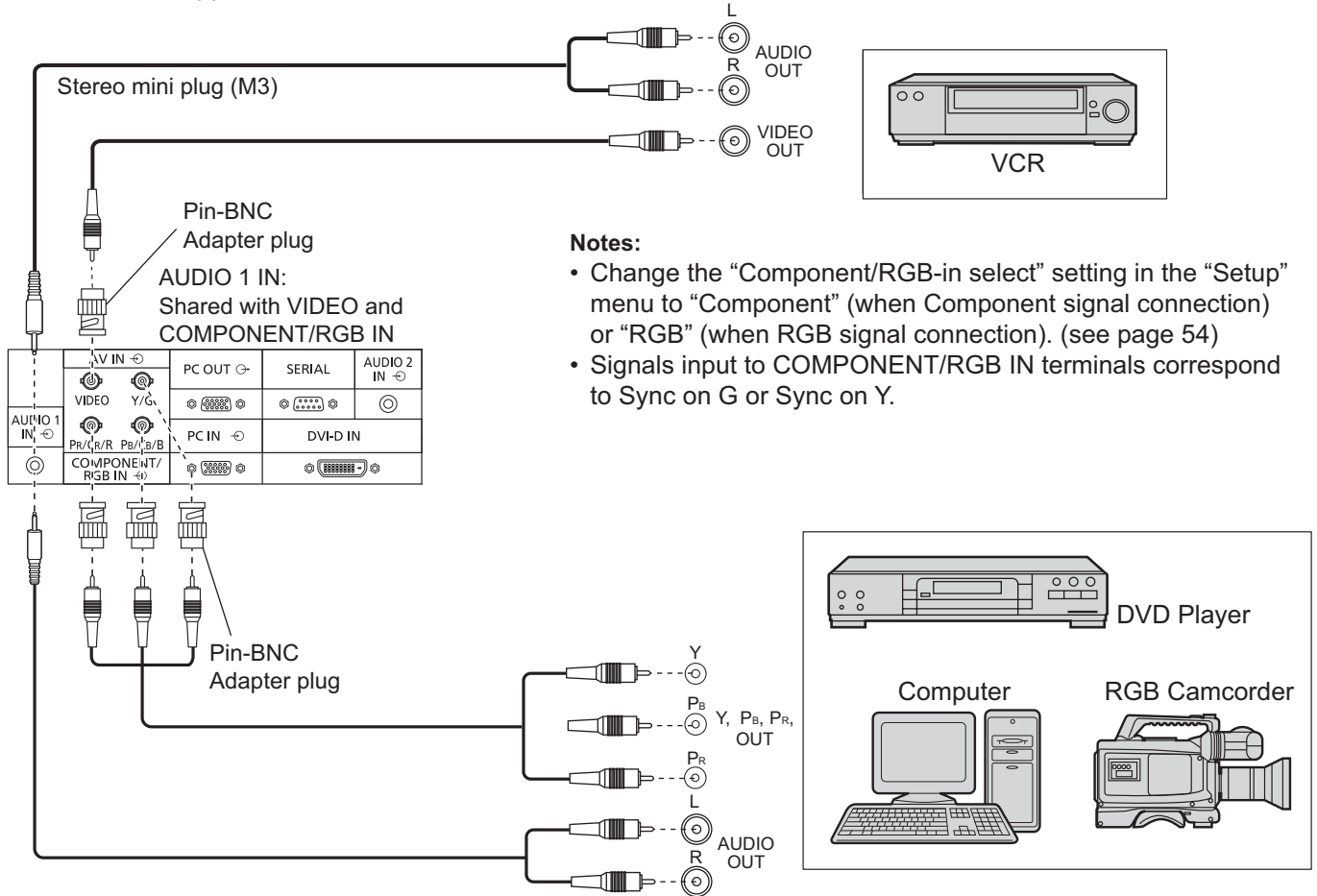

# HDMI connection

[Pin assignments and signal names]

Pin No.	Signal name	Pin No.	Signal name
①	T.M.D.S Data2+	⑪	T.M.D.S Clock Shield
②	T.M.D.S Data2 Shield	⑫	T.M.D.S Clock-
③	T.M.D.S Data2-	⑬	CEC
④	T.M.D.S Data1+	⑭	Reserved (N.C. on device)
⑤	T.M.D.S Data1 Shield		
⑥	T.M.D.S Data1-	⑮	SCL
⑦	T.M.D.S Data0+	⑯	SDA
⑧	T.M.D.S Data0 Shield	⑰	DDC/CEC Ground
⑨	T.M.D.S Data0-	⑱	+5V Power
⑩	T.M.D.S Clock+		Hot Plug Detect

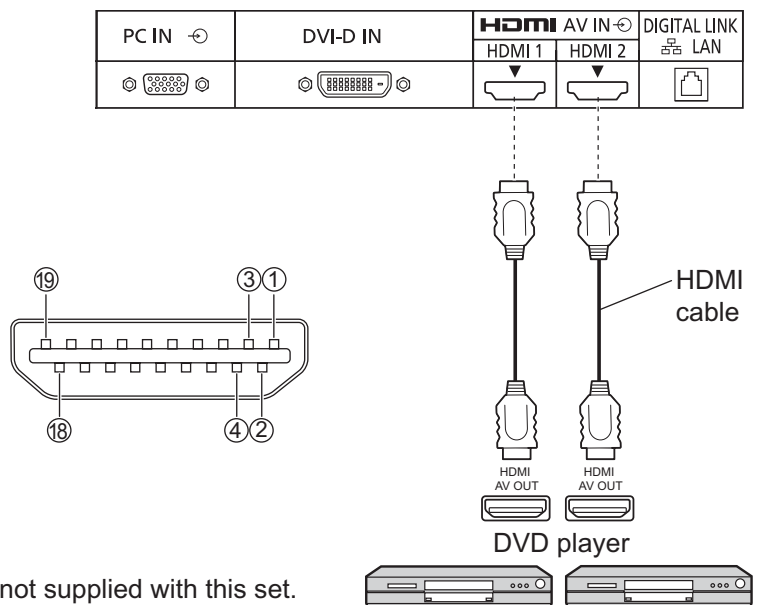

**Note:**

Additional equipment and HDMI cable shown are not supplied with this set.

## DVI-D IN connection

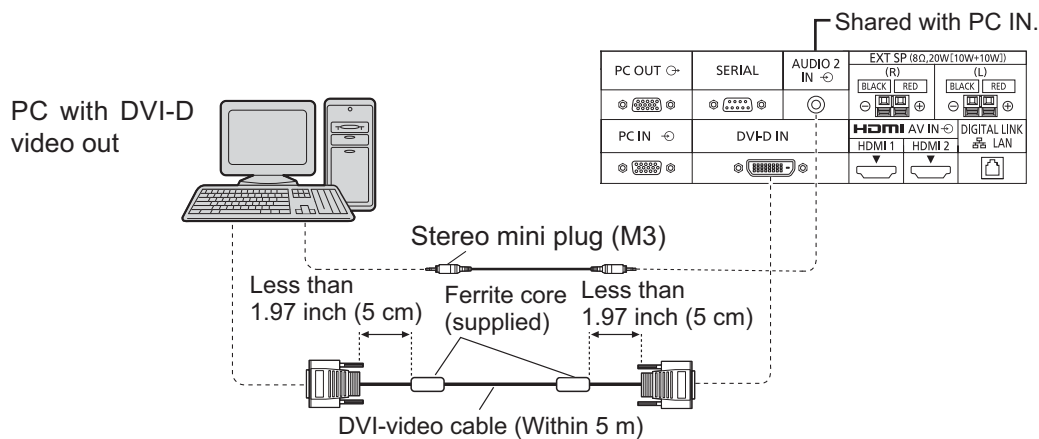

### Installing the Ferrite core

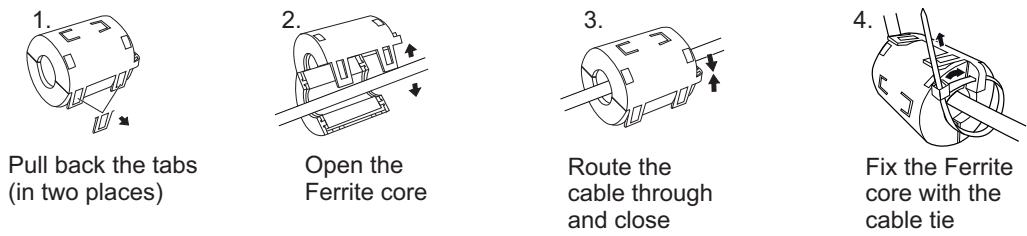

### DVI-D Input Connector Pin Layouts

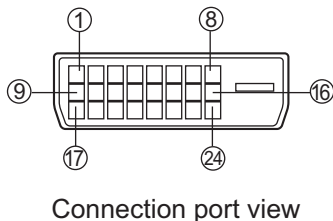

Pin No.	Signal Name	Pin No.	Signal Name
①	T.M.D.S. data 2-	⑬	_____
②	T.M.D.S. data 2+	⑭	+5 V DC
③	T.M.D.S. data 2 shield	⑮	Ground
④	_____	⑯	Hot plug detect
⑤	_____	⑰	T.M.D.S. data 0-
⑥	DDC clock	⑱	T.M.D.S. data 0+
⑦	DDC data	⑲	T.M.D.S. data 0 shield
⑧	_____	⑳	_____
⑨	T.M.D.S. data 1-	㉑	_____
⑩	T.M.D.S. data 1+	㉒	T.M.D.S. clock shield
⑪	T.M.D.S. data 1 shield	㉓	T.M.D.S. clock+
⑫	_____	㉔	T.M.D.S. clock-

### Notes:

- Additional equipment and cables shown are not supplied with this set.
- Use the DVI-D cable complying with the DVI standard. Image deterioration may occur depending on the length or the quality of the cable.



# PC Input Terminals connection

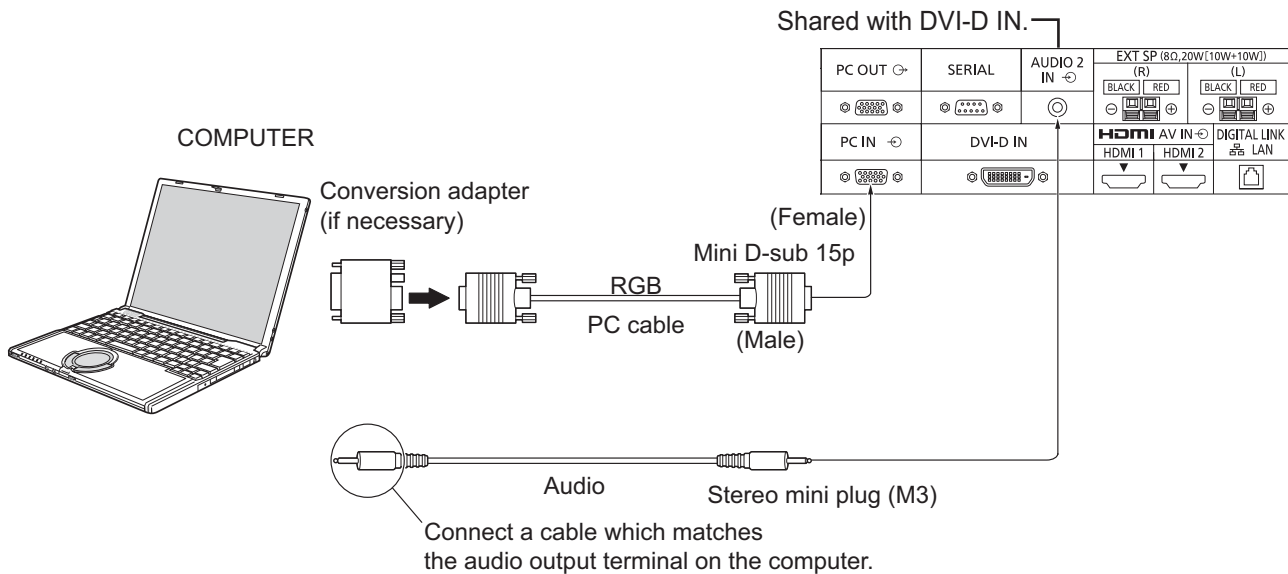

**Notes:**

- With regard to the typical PC input signals that are described in the applicable input signals list (see page 71), adjustment values such as for the standard picture positions and sizes have already been stored in this unit. You can add up to eight PC input signal types that are not included in the list.
- Computer signals which can be input are those with a horizontal scanning frequency of 15 to 110 kHz and vertical scanning frequency of 48 to 120 Hz. (However, the image will not be displayed properly if the signals exceed 1,200 lines.)
- The display resolution is a maximum of 1,440 × 1,080 dots when the aspect mode is set to “4:3”, and 1,920 × 1,080 dots when the aspect mode is set to “16:9”. If the display resolution exceeds these maximums, it may not be possible to show fine detail with sufficient clarity.
- The PC input terminals are DDC2B-compatible. If the computer being connected is not DDC2B-compatible, you will need to make setting changes to the computer at the time of connection.
- Some PC models cannot be connected to the set.
- There is no need to use an adapter for computers with DOS/V compatible Mini D-sub 15P terminal.
- The computer shown in the illustration is for example purposes only.
- Additional equipment and cables shown are not supplied with this set.
- Do not set the horizontal and vertical scanning frequencies for PC signals which are above or below the specified frequency range.
- Component Input is possible with the pin 1, 2, 3 of the Mini D-sub 15P Connector.
- Change the “Component/RGB-in select” setting in the “Setup” menu to “Component” (when Component signal connection) or “RGB” (when RGB signal connection). (see page 54)

**Signal Names for Mini D-sub 15P Connector**

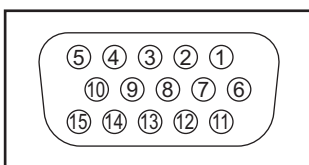

Pin No.	Signal Name	Pin No.	Signal Name	Pin No.	Signal Name
①	R (P <sub>R</sub> /C <sub>R</sub> )	⑥	GND (Ground)	⑪	NC (not connected)
②	G (Y)	⑦	GND (Ground)	⑫	SDA
③	B (P <sub>B</sub> /C <sub>B</sub> )	⑧	GND (Ground)	⑬	HD/SYNC
④	NC (not connected)	⑨	+5 V DC	⑭	VD
⑤	GND (Ground)	⑩	GND (Ground)	⑮	SCL

Pin Layout for PC Input Terminal

## SERIAL Terminal connection

The SERIAL terminal is used when the Display is controlled by a computer.

**Note:** To use serial control for this unit, make sure to set the “Control I/F Select” in the “Network Settings” menu to “RS-232C”. (refer to “Operating Instructions, Network Operations”)

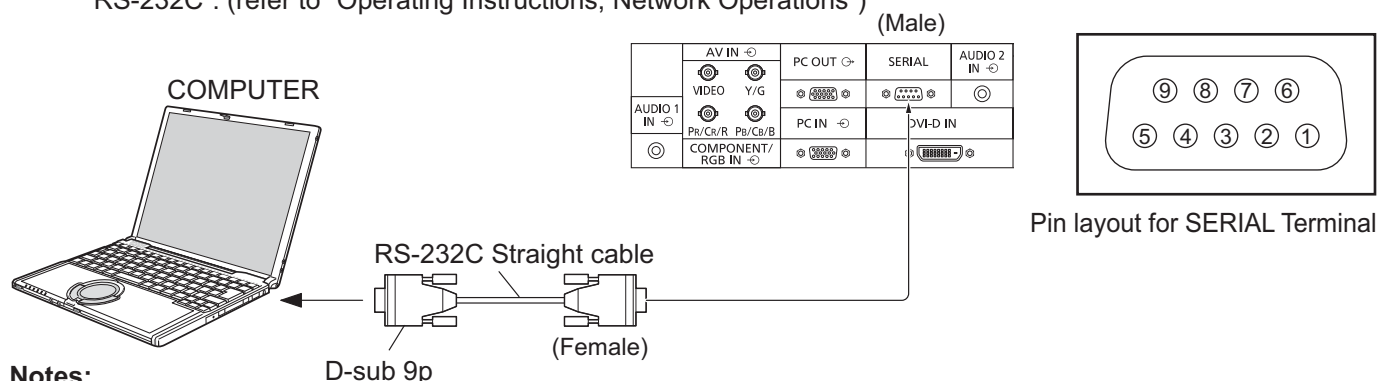

**Notes:**

- Use the RS-232C straight cable to connect the computer to the Display.
- The computer shown is for example purposes only.
- Additional equipment and cables shown are not supplied with this set.

The SERIAL terminal conforms to the RS-232C interface specification, so that the Display can be controlled by a computer which is connected to this terminal.

The computer will require software which allows the sending and receiving of control data which satisfies the conditions given below. Use a computer application such as programming language software. Refer to the documentation for the computer application for details.

**Communication parameters**

Signal level	RS-232C compliant
Synchronization method	Asynchronous
Baud rate	9600 bps
Parity	None
Character length	8 bits
Stop bit	1 bit
Flow control	None

**Basic format for control data**

The transmission of control data from the computer starts with a STX signal, followed by the command, the parameters, and lastly an ETX signal in that order. If there are no parameters, then the parameter signal does not need to be sent.

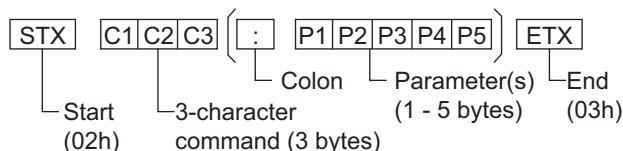

**Notes:**

- If multiple commands are transmitted, be sure to wait for the response for the first command to come from this unit before sending the next command.
- If an incorrect command is sent by mistake, this unit will send an “ER401” command back to the computer.
- S1A and S1B of Command IMS are available only when a dual input terminal board is attached.
- Consult your local Panasonic dealer for detail instructions on command usage.

**Signal names for D-sub 9P connector**

Pin No.	Details
②	R X D
③	T X D
⑤	GND
④ • ⑥	Non use
⑦ ⑧	(Shorted in this set)
① • ⑨	NC

These signal names are those of computer specifications.

**Command**

Command	Parameter	Control details
PON	None	Power ON
POF	None	Power OFF
AVL	**	Volume 00 - 63
AMT	0	Audio MUTE OFF
	1	Audio MUTE ON
IMS	None	Input select (toggle)
	SL1	SLOT input (SLOT INPUT)
	S1A	SLOT input (SLOT INPUT A)
	S1B	SLOT input (SLOT INPUT B)
	VD1	VIDEO input (VIDEO)
	YP1	COMPONENT/RGB IN input (COMPONENT)
	HM1	HDMI 1 input (HDMI1)
	HM2	HDMI 2 input (HDMI2)
	DV1	DVI-D IN input (DVI)
	PC1	PC IN input (PC)
	DL1	DIGITAL LINK input (DIGITAL LINK)
	MG1	Miracast input (Miracast(TM))
MV1	Memory viewer input (MEMORY VIEWER)	

With the power off, this display responds to PON command only.

# PC OUT connection

The image being reproduced on the display including the image input from video equipment can be displayed on another sub monitor.

To use the function, set “Monitor Out” to “On” in “Setup”. (see page 52)

**Note:** Setting it to “On” will adjust the “Picture” menu values to the standard values.

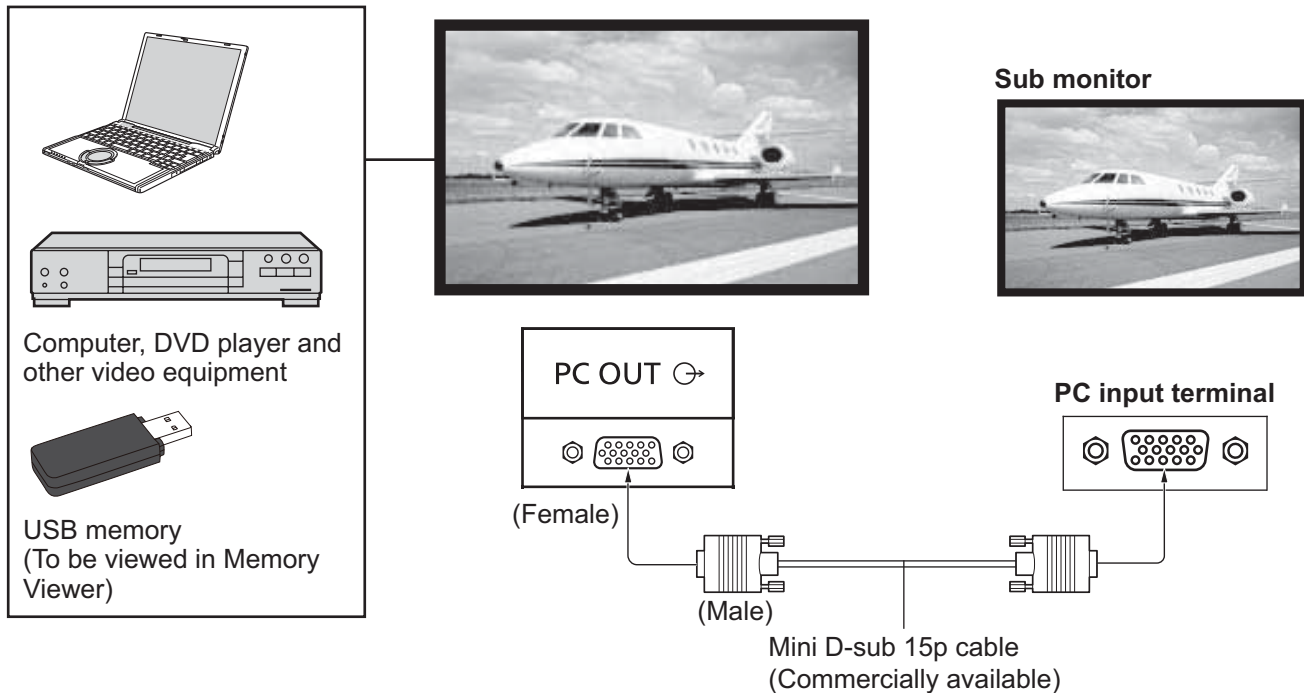

### Input signals that can be output

Input signal	Output signal
HDMI input signal (HDMI 1, HDMI 2) HDCP (copy protection) not supported	1,920 x 1,080@50 Hz or 1,920 x 1,080@60 Hz
DVI input signal (DVI-D IN) HDCP (copy protection) not supported	1,920 x 1,080@50 Hz or 1,920 x 1,080@60 Hz
PC input signal (PC IN) When “Component/RGB-in select” is set to “RGB”	1,920 x 1,080@50 Hz or 1,920 x 1,080@60 Hz
Memory Viewer screen (MEMORY VIEWER)	1,920 x 1,080@60 Hz

### Notes:

- The aspect ratio of the output signal is changed so that it can be shown on the screen.
- The following input signals cannot be output.  
Component input (COMPONENT/RGB IN)  
Composite video input (VIDEO)  
Miracast image (Miracast(TM))  
Wireless Manager (Panasonic APPLICATION)

### Pin Layout and Signal Names of Monitor Out Terminal (Mini-D-sub 15P)

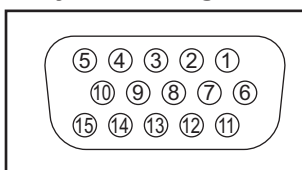

Pin No.	Signal Name	Pin No.	Signal Name	Pin No.	Signal Name
①	R	⑥	GND (Ground)	⑪	NC (not connected)
②	G	⑦	GND (Ground)	⑫	NC (not connected)
③	B	⑧	GND (Ground)	⑬	HD
④	NC (not connected)	⑨	+5 V DC	⑭	VD
⑤	GND (Ground)	⑩	GND (Ground)	⑮	NC (not connected)

# Example connection using the DIGITAL LINK Terminal

A twisted pair cable transmitter such as the Panasonic Digital Interface Box (ET-YFB100G) uses twisted pair cables to transmit inputted video and audio signals, and these digital signals can be input to the Display via the DIGITAL LINK terminal.

Display Connection Terminals

SERIAL	AUDIO 2 IN	EXT SP (8Ω, 20W[10W+10W])			
		(R)		(L)	
		BLACK	RED	BLACK	RED
DVI-D IN		HDMI AV IN		DIGITAL LINK	
		HDMI 1	HDMI 2	LAN	
				LAN	

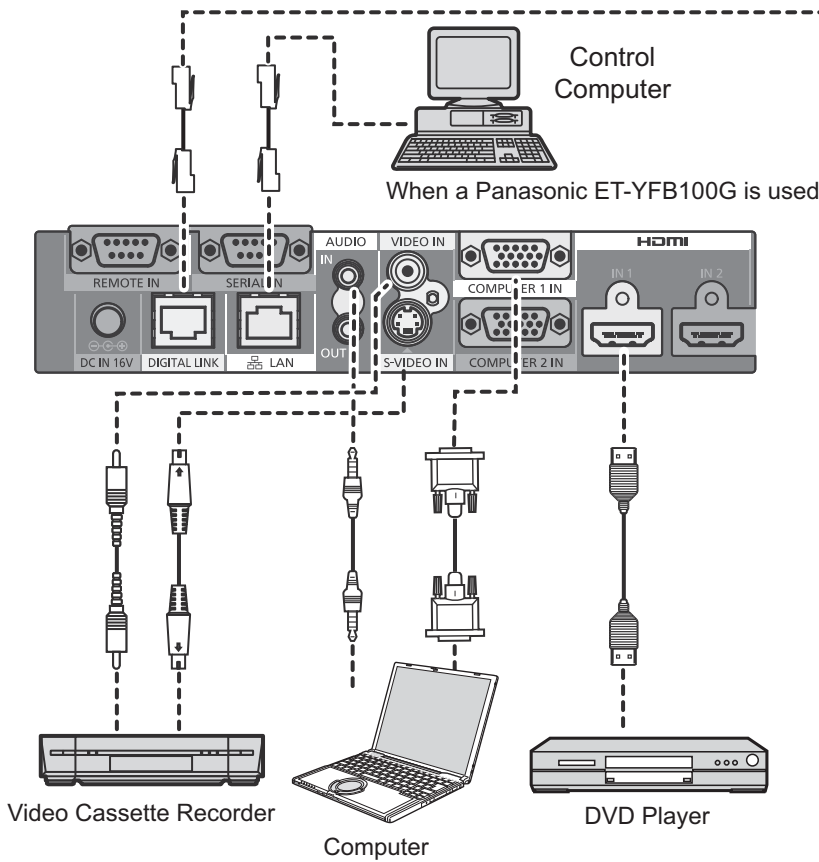

**Note:**

When connecting with DIGITAL LINK, be sure to configure each of the “Network Settings” settings. For the cautions for DIGITAL LINK setting and connection, refer to “Operating Instructions - Network Operations”.

# Power On / Off

## Connecting the AC cord plug to the Display.

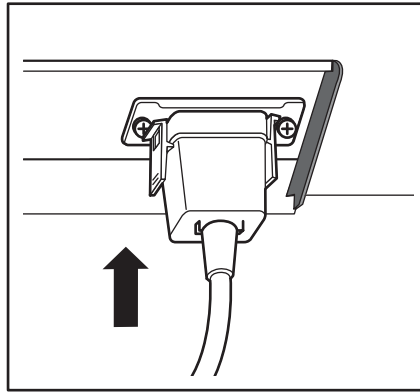
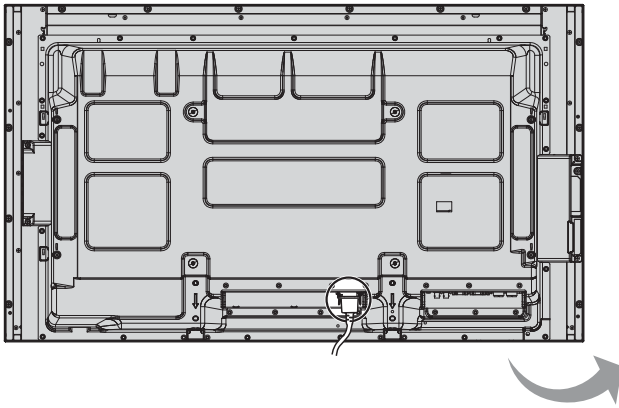

## Connecting the plug to the Wall Outlet

### Notes:

- Main plug types vary between countries. The power plug shown at right may, therefore, not be the type fitted to your set.
- When disconnecting the AC cord, be absolutely sure to disconnect the AC cord plug at the socket outlet first.

Press the Power switch on the Display to turn the set on: Power-On.

Power Indicator: Green

### [Starting up the network]

It takes some time for the network to start up just after the power is turned on. During that time, "Network Setup" in the "Setup" menu is grayed out and cannot be set.

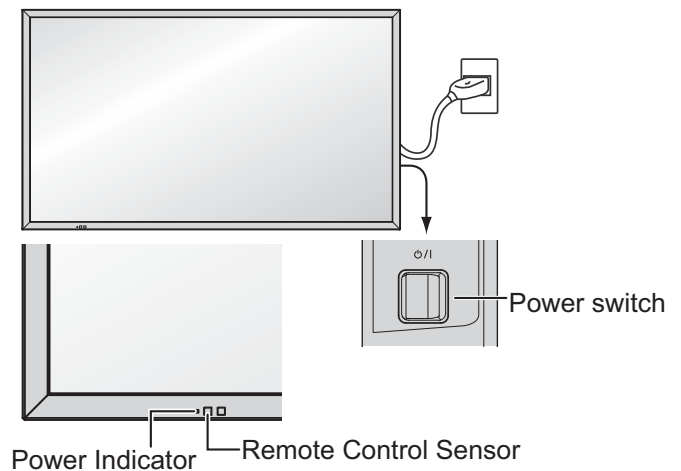

Press the  button on the remote control to turn the Display off.

Power Indicator: Red (standby)

Press the  button on the remote control to turn the Display on.

Power Indicator: Green

Turn the power to the Display off by pressing the  switch on the unit, when the Display is on or in standby mode.

### Note:

During operation of the power management function, the power indicator turns orange in the power off state.

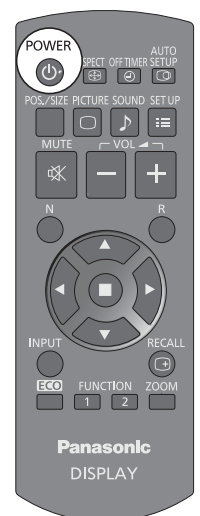

## When first switching on the unit

Following screen will be displayed when the unit is turned on for the first time. Select the items with the remote control. Unit buttons are invalid.

### OSD Language

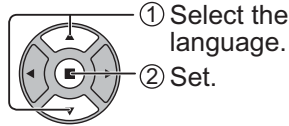

### Day/Time Settings

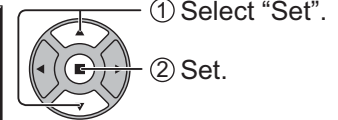
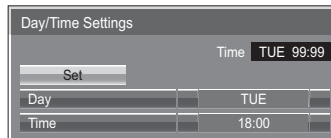
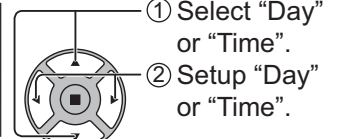
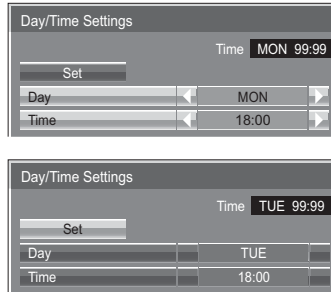

### Notes:

- Once the items are set, the screens won't be displayed when switching on the unit next time.
- After the setting, the items can be changed in the following menus.  
OSD Language (see page 53)  
Day/Time Settings (see page 45)

### Power ON message

The following message may be displayed when turning the unit power ON:

#### No activity power off Precautions

'No activity power off' is enabled.

If "No activity power off" in Setup menu is set to "Enable", a warning message is displayed every time the power is turned ON. (see page 53)

#### Power Management Information

Last turn off due to 'Power management'.

If "Power management" is functioned, an information message is displayed every time the power is turned ON. (see page 49)

These message displays can be set with the following menu: Options menu  
Power On Message (No activity power off) (see page 61)  
Power On Message (Power Management) (see page 61)

## Displaying network information

The network information for the Display will be displayed in the following scenarios.

The power is turned ON with Panasonic APPLICATION selected as the input.

The input is switched to Panasonic APPLICATION.

The button is pushed with Panasonic APPLICATION selected as the input.

Display example:

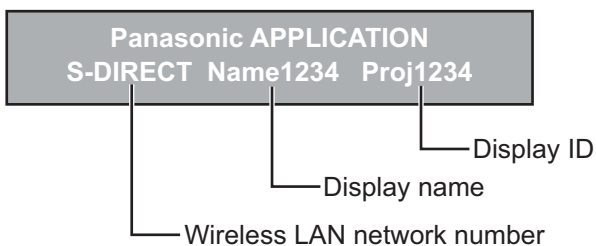

# Selecting the input signal

INPUT



Press to select the input signal to be played back from the equipment which has been connected to the Display.

Alternatively you can press , press ▲▼ to select the input and press .

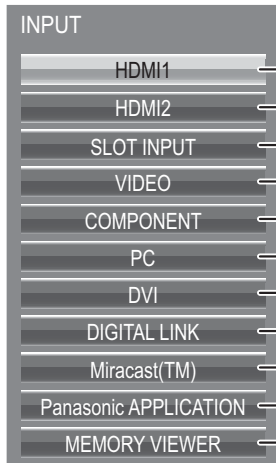

- HDMI input in HDMI 1 terminal
- HDMI input in HDMI 2 terminal
- Input signal in a Terminal Board\*1
- Composite video input in VIDEO terminal
- Component/RGB input in COMPONENT/RGB IN terminal\*2
- Computer's signal input in PC IN terminal
- DVI-D input in DVI-D IN terminal
- DIGITAL LINK input in DIGITAL LINK terminal
- Select this input when using the Miracast function. (see page 33)
- Select this input when using "Wireless Manager" via wired/wireless LAN.
- Select this input when using the Memory Viewer function. (see page 30)

\*1 "SLOT INPUT" appears when an optional Terminal Board is connected.

When a Terminal Board with dual input terminals is connected, "SLOT INPUT A" and "SLOT INPUT B" will appear. When a Terminal Board incompatible with the Display is installed, "Non-Compatible Function Board" is displayed.

\*2 "COMPONENT" may be displayed as "RGB" depending on the setting of "Component/RGB-in select". (see page 54)

## Notes:

- Selecting is also possible by pressing the INPUT button on the unit.
- Outputs the sound as set in "Audio input select" in the Options menu. (see page 63)
- Select to match the signals from the source connected to the component/RGB input terminals. (see page 54)
- Image retention (image lag) may occur on the LCD display panel when a still picture is kept on the panel for an extended period. To prevent such a problem, using the screensaver is recommended. (see page 47)
- The connection of the Wireless Manager is interrupted if the input is switched from Panasonic APPLICATION to Miracast(TM) or MEMORY VIEWER. The connection of Miracast is interrupted if the input is switched from Miracast(TM) to Panasonic APPLICATION or MEMORY VIEWER. Please check the setting again after switching the input.

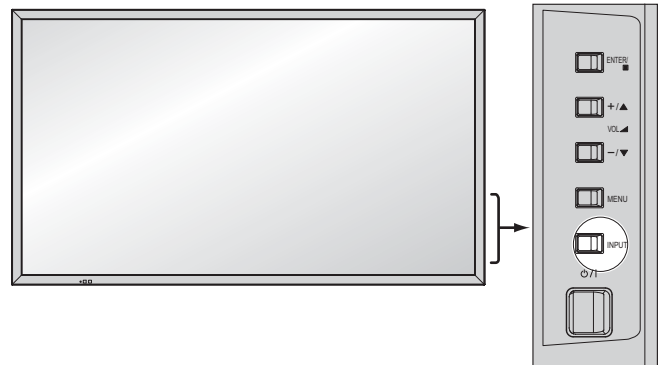

# Basic Controls

## Main Unit

### For 50 inch and 65 inch models



**Remote control sensor**

#### Power Indicator

The Power Indicator will light.

- Power-OFF .... Indicator not illuminated (The unit will still consume some power as long as the power cord is still inserted into the wall outlet.)
- Standby ..... Red
  - Orange (When "Slot power" is set to "On" and Terminal Board is installed. See page 60)
  - Orange (Depending on the type of the function board installed, when the power is supplied to the slot)
  - Orange (When "Control I/F Select" is set to "DIGITAL LINK/LAN" or "Wireless Network Standby" is set to "On". Refer to "Operating Instructions, Network Operations")
- Power-ON ..... Green
- HDMI1 Power management  
HDMI2 Power management  
..... Orange (With HDMI1 or HDMI2 input signal. See page 49)
- \* These functions are not supported by TH-50LFC70E and TH-65LFC70E.
- PC Power management (DPMS)  
..... Orange (With PC input signal. See page 49)
- DVI-D Power management  
..... Orange (With DVI input signal. See page 49)

#### Note:

If the power indicator is orange, power consumption during standby is generally larger than that of when the power indicator is red.

#### Brightness Sensor

Detects the brightness in the viewing environment. (see page 49)

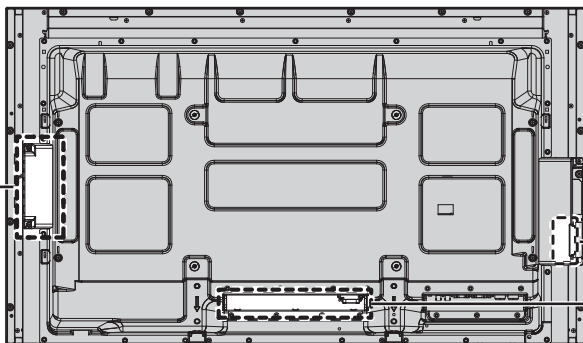

**USB (VIEWER):** Connect to USB memory. (see page 29)

**SLOT:** Terminal board (optional accessories) insert slot (see page 4)

#### Note:

The right side slot is for terminal board with 2-slot width. The terminal board with 1-slot width does not function when installed in the right side slot.

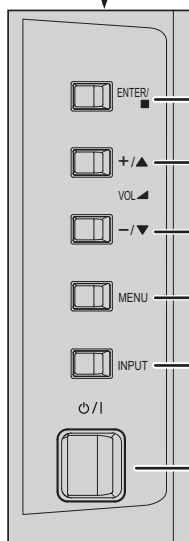

**Enter / Aspect button**  
(see page 25, 34)

#### Volume Adjustment

Volume Up "+" Down "-"  
When the menu screen is displayed:  
"+": press to move the cursor up  
"-": press to move the cursor down  
(see page 34)

#### MENU Screen ON / OFF

Each time the MENU button is pressed, the menu screen will switch.  
(see page 34)

**INPUT button (INPUT signal selection)**  
(see page 21)

**Main Power On / Off Switch**



## For 80 inch model

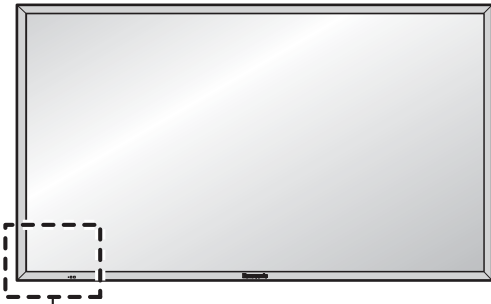

**Remote control sensor**

### Power Indicator

The Power Indicator will light.

- Power-OFF .... Indicator not illuminated (The unit will still consume some power as long as the power cord is still inserted into the wall outlet.)
- Standby ..... Red
  - Orange (When "Slot power" is set to "On" and Terminal Board is installed. See page 60)
  - Orange (Depending on the type of the function board installed, when the power is supplied to the slot)
  - Orange (When "Control I/F Select" is set to "DIGITAL LINK/LAN" or "Wireless Network Standby" is set to "On". Refer to "Operating Instructions, Network Operations")
- Power-ON ..... Green
- HDMI1 Power management  
HDMI2 Power management  
..... Orange (With HDMI1 or HDMI2 input signal. See page 49)
- \* These functions are not supported by TH-80LFC70E.
- PC Power management (DPMS)  
..... Orange (With PC input signal. See page 49)
- DVI-D Power management  
..... Orange (With DVI input signal. See page 49)

### Note:

If the power indicator is orange, power consumption during standby is generally larger than that of when the power indicator is red.

### Brightness Sensor

Detects the brightness in the viewing environment. (see page 49)

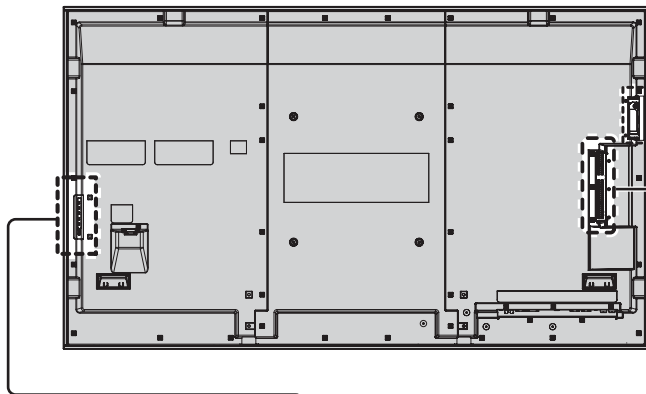

**USB (VIEWER):** Connect to USB memory. (see page 29)

**SLOTT:** Terminal board (optional accessories) insert slot (see page 4 )

### Note:

The upper side slot is for terminal board with 2-slot width. The terminal board with 1-slot width does not function when installed in the upper side slot.

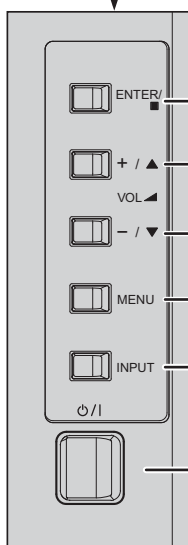

### Enter / Aspect button

(see page 25, 34)

### Volume Adjustment

Volume Up "+" Down "-"

When the menu screen is displayed:

"+": press to move the cursor up

"-": press to move the cursor down

(see page 34)

### MENU Screen ON / OFF

Each time the MENU button is pressed, the menu screen will switch.

(see page 34)

### INPUT button (INPUT signal selection)

(see page 21)

### Main Power On / Off Switch

## Remote Control Transmitter

**ACTION button**  
Press to make selections.

**ASPECT button**  
Press to adjust the aspect.  
(see page 25)

**Standby (ON / OFF) button**  
The Display must first be plugged into the wall outlet and turned on at the power switch (see page 19). Press this button to turn the Display On, from Standby mode. Press it again to turn the Display Off to Standby mode.

**POS./SIZE button**  
(see page 35)

**PICTURE button**  
(see page 38)

**Sound mute On / Off**  
Press this button to mute the sound.  
Press again to reactivate sound.  
Sound is also reactivated when power is turned off or volume level is changed.

**N button**  
(see page 37, 38, 39, 43)

**POSITION buttons**

**INPUT button**  
Press to select Input signal sequentially. (see page 21)

**ECO MODE (ECO)**  
Press to change the ECO MODE setup status. (see page 49)

**FUNCTION buttons (FUNCTION)**  
(see page 51)

### OFF TIMER button

The Display can be preset to switch to stand-by after a fixed period. The setting changes to 30 minutes, 60 minutes, 90 minutes and 0 minutes (off timer cancelled) each time the button is pressed.

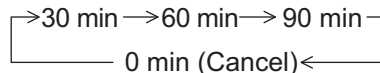

When three minutes remain, "Off timer 3 min" will flash.

The off timer is cancelled if a power interruption occurs.

### AUTO SETUP button

Automatically adjusts the position/size of the screen. (see page 35)

**SET UP button** (see page 44)

**SOUND button** (see page 43)

### Volume Adjustment

Press the Volume Up "+" or Down "-" button to increase or decrease the sound volume level.

**R button** (see page 34)

Press the R button to return to previous menu screen.

### RECALL button

Press the "RECALL" button to display the current system status.

- ① Input label
- ② Aspect mode (see page 25)  
Audio input (see page 63)  
Profile name (see page 42)
- ③ Off timer  
The off timer indicator is displayed only when the off timer has been set.
- ④ Clock display (see page 60)

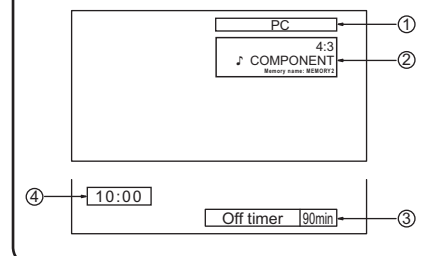

**Digital Zoom** (see page 26)

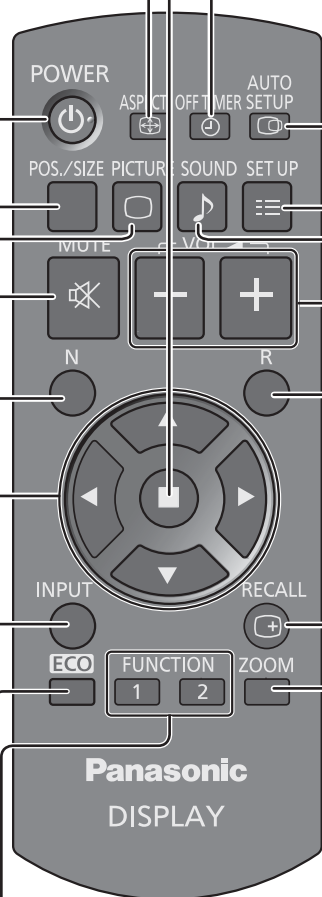

# ASPECT Controls

The Display will allow you to enjoy viewing the picture at its maximum size, including wide screen cinema format picture.

## Note:

Be aware that if you put the display in a public place for commercial purposes or a public showing and then use the aspect mode select function to shrink or expand the picture, you may be violating the copyright under copyright law. It is prohibited to show or alter the copyrighted materials of other people for commercial purposes without the prior permission of the copyright holder.

ASPECT



Press repeatedly to move through the aspect options:  
For details about the aspect mode, please see "List of Aspect Modes" (page 69).

[from the unit]



The aspect mode changes each time the ENTER button is pressed.

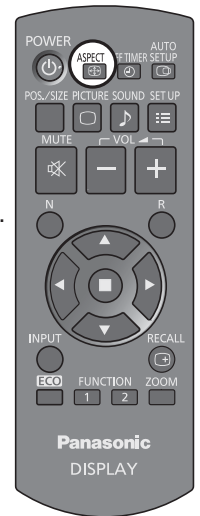

## [TH-50LFC70U, TH-65LFC70U, TH-80LFC70U]

For VIDEO (S VIDEO) signal input:

→ 4:3 → ZOOM → FULL → JUST →

For PC signal input:

→ 4:3 → ZOOM → FULL →

For SD signal input (525 (480) / 60i • 60p, 625 (575) / 50i • 50p):

→ 4:3 → ZOOM → FULL → JUST →

For HD signal input [1125 (1080) / 60i • 50i • 60p • 50p • 24p • 25p • 30p • 24psF, 1250 (1080) / 50i, 750 (720) / 60p • 50p]:

→ 4:3 → H-FILL → ZOOM → FULL → JUST →

With the following inputs, the aspect will be fixed to "FULL" and you cannot switch it.

Miracast(TM), MEMORY VIEWER

## [TH-50LFC70E, TH-65LFC70E, TH-80LFC70E, TH-50LFC70W, TH-65LFC70W, TH-80LFC70W]

For VIDEO (S VIDEO) signal input:

→ 4:3 → Zoom1 → Zoom2 → Zoom3 → 16:9 → 14:9 → Just →

For PC signal input:

→ 4:3 → Zoom → 16:9 →

For SD signal input (525 (480) / 60i • 60p, 625 (575) / 50i • 50p):

→ 4:3 → Zoom1 → Zoom2 → Zoom3 → 16:9 → 14:9 → Just →

For HD signal input [1125 (1080) / 60i • 50i • 60p • 50p • 24p • 25p • 30p • 24psF, 1250 (1080) / 50i, 750 (720) / 60p • 50p]:

→ 4:3 → 4:3 Full → Zoom1 → Zoom2 →  
Just ← 14:9 ← 16:9 ← Zoom3 ←

With the following inputs, the aspect will be fixed to "16:9" and you cannot switch it.

Miracast(TM), MEMORY VIEWER

## Notes:

- The aspect mode is memorized separately for each input terminal.
- Do not allow the picture to be displayed in 4:3 mode for an extended period, as this can cause a permanent image retention to remain on the Display Panel.

## All Aspect mode

Set "All Aspect" to "On" in Options menu to enable the extended aspect mode (page 60). When All Aspect mode, the aspect mode of pictures is switched as follows. For details about the aspect mode, please see "List of Aspect Modes". (page 69)

For VIDEO (S VIDEO) signal input:

→ 4:3 → Zoom1 → Zoom2 → Zoom3 → 16:9 → 14:9 → Just →

For PC signal input:

→ 4:3 → Zoom → 16:9 →

For SD signal input (525 (480) / 60i • 60p, 625 (575) / 50i • 50p):

→ 4:3 → Zoom1 → Zoom2 → Zoom3 → 16:9 → 14:9 → Just →

For HD signal input [1125 (1080) / 60i • 50i • 60p • 50p • 24p • 25p • 30p • 24psF, 1250 (1080) / 50i, 750 (720) / 60p • 50p]:

→ 4:3 Full → Zoom1 → Zoom2 → Zoom3 → 16:9 → 14:9 → Just1 → Just2 → 4:3 (1) → 4:3 (2) →

# Digital Zoom

This displays an enlargement of the designated part of the displayed image.

## 1 Display the operation guide.

**ZOOM**  
 Press to access Digital Zoom.  
 The operation guide will be displayed.

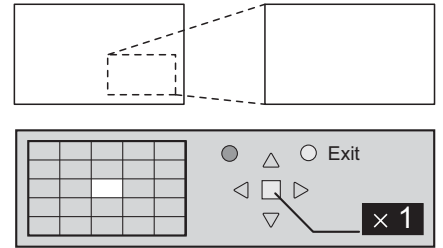

**During Digital Zoom, only the following buttons can be operated.**

[Remote control]

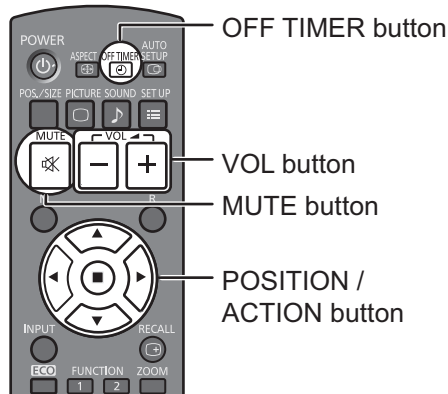

[Unit]

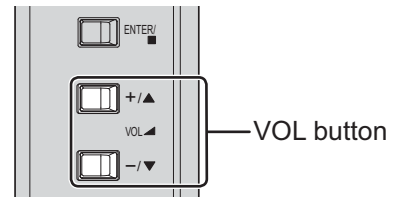

## 2 Select the area of the image to be enlarged.

Press on the enlargement location to select.  
 The cursor will move.

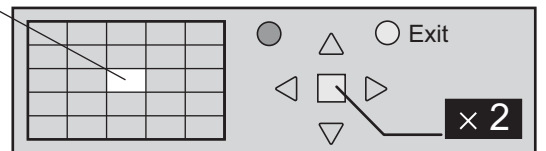
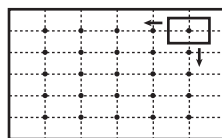
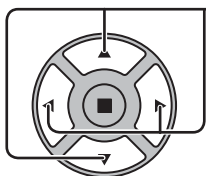

## 3 Select the magnification required for the enlarged display.

Each time this is pressed, the magnification factor changes.  
 This is shown in the image being displayed.

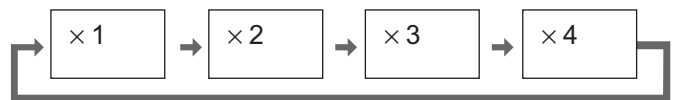
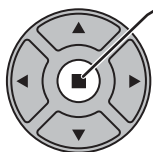

## 4 Return to normal display (quit Digital Zoom).

**R**  
 Press to exit from the Digital Zoom.

### Notes:

- When power goes OFF (including “Off Timer” operation), Digital Zoom terminates.
- The Digital Zoom function cannot be selected while in the following operation state:  
 When two screen display.  
 When Screensaver (except for Negative image) is running (see page 47)  
 When the thumbnail view or file list view of Memory Viewer is displayed
- While Digital Zoom is in operation, “Adjusting Pos./Size” cannot be used.

# MULTI PIP

You can display two pictures, such as a video image and computer image, in a two-screen display.

## Notes:

- If "Input lock" in Options menu is set to other than "Off", two screen display function isn't available (see page 59).
- 2k1k signals that are received with the Dual Link HD-SDI Terminal Board (TY-FB11DHD) cannot be displayed in two-screen display.

## MULTI PIP Settings

Set the functions for two-screen display in "MULTI PIP Settings" in the Setup menu. (see page 46)

## PIP Mode

### Pic in Pic

Displays two input images combined.



Main screen input  
Sub screen input

The following four system inputs are combined:

**A** Panasonic APPLICATION

**B** SLOT INPUT

**C** HDMI1/HDMI2/DVI/DIGITAL LINK/COMPONENT/PC

**D** VIDEO

### Note:

Two screen display cannot be displayed with the same system inputs such as HDMI1-DVI combined.

### Note:

SD signal is displayed in 4:3 mode on the sub screen.

## Using Two Screen Display

Set "MULTI PIP" in "MULTI PIP Settings" to "On" (see page 46).

Two screen display appears.

### Using the FUNCTION button

FUNCTION 1 2 → On/Off of "MULTI PIP" switches.

FUNCTION 1 2 → "MULTI PIP Settings" menu appears.

### Note:

Please use the "Function Button Settings" to set the FUNCTION button (see page 51).

### Switching Sub Screen Position



Press to switch the sub screen position.

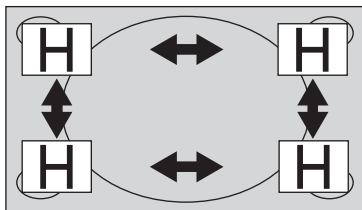

### Changing the Size of Sub Screen

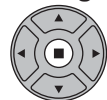

Press to change the size of the sub screen.

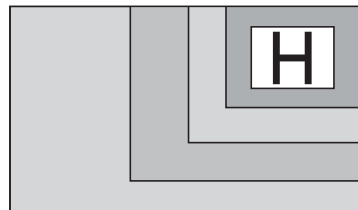

### Note:

Alternatively, "Sub screen size" and "Sub screen position" in "MULTI PIP Settings" can be used for the same operation (see page 46).

# Memory Viewer Function

The Memory Viewer function makes it possible to display the video and pictures which are stored in the USB memory when the USB memory is inserted into the display.

## What you can display with the Memory Viewer function

The following files are supported.

Picture	Extension	Format
	<b>jpg/jpeg</b>	Maximum resolution: 8000 × 8000
	<b>bmp</b>	Maximum resolution: 8000 × 8000 support: 1, 4, 8, 16, 24, 32 bit

Video	Extension	Video codec	Audio codec	Video format	Audio format
	<b>mov</b>	H.264/AVC MotionJpeg	AAC Linear PCM	Maximum: 1920 × 1080/30 fps	Maximum: 48 kHz 2 ch (It is up to 16 kHz stereo when the codec is linear PCM)
	<b>avi</b>	H.264/AVC MotionJpeg Mpeg4	mp3 AAC Linear PCM		
	<b>mp4</b>	H.264/AVC Mpeg4	AAC Mpeg4 AAC-LC		
	<b>mpg/mpeg</b>	Mpeg2	Mpeg1 Layer2		
	<b>wmv</b>	WMV9	WMA		

### Notes:

- The maximum size of file is 2 GB.
- The maximum number of file/folder is up to 1000. If it exceeds, the folder cannot display and an error message appears.
- You cannot play the files which are protected by Digital Rights Management (DRM).
- The maximum number of files that can hold resume information is 50. If it exceeds 50, the oldest information will be deleted.
- It may be impossible to resume playing the file from the stopped position.
- It may be impossible to play some files even if they are in the supported format.

### Applicable device

The function is compatible with USB memories sold in the market. (Devices with security feature are not supported)  
Devices not formatted with FAT16 or FAT32 cannot be used.

## Inserting the USB memory

Insert the USB memory to the USB (VIEWER) port on the side of the display.

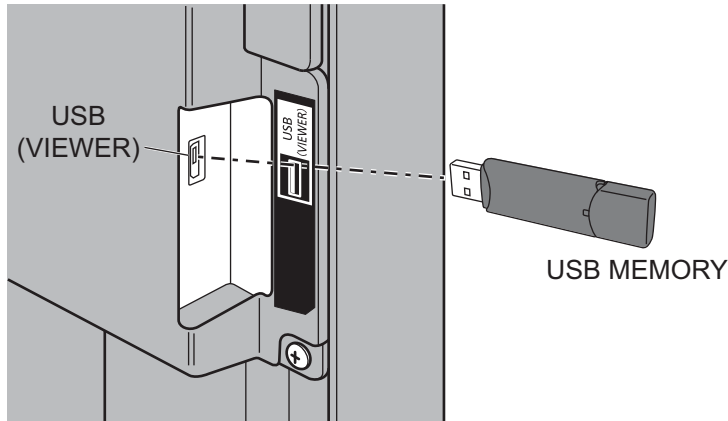

### Notes:

- When inserting the USB memory, confirm the direction of the plug not to damage the terminal.
- Please note following points to insert and remove the USB memory.
  - The indicator of the inserted USB memory will be blinking while the display is reading out the data. Do not remove the USB memory while it is blinking.
  - When using a USB memory without indicator, you cannot recognize when the display is reading out the data. Please remove it from the display after closing the Memory Viewer function or turning off the display.
  - Do not insert and remove the USB memory frequently. Remove the USB memory at least 5 seconds after insertion. And insert at least 5 seconds after removal. The display needs some time to detect insertion or removal of the USB memory.

## Caution on handling and storing the USB memory

- Do not put USB memory or its cap within close reach of children. Swallowing it may cause suffocation.
- If the smoke or questionable odor rises, remove the USB memory from the equipment and contact the manufacturer.
- Do not put water, chemical or oil to the USB memory. It may cause short out or fire.
- Do not put foreign objects or put metal objects to the USB terminal. Static electricity may cause data loss or data corruption.
- Do not remove the USB memory from the computer or the display while the USB memory is reading out or writing the data. It may cause data loss or data corruption.
- Do not store the USB memory in hot, humid or dusty place or near magnetized items.

### Notes:

- During accessing to the USB memory, do not turn off the power or remove the USB memory because the data in the USB memory might get damaged. During accessing, the USB memory is blinking.
- The USB memory allows you to insert or remove regardless of the power status of the display.

# Memory Viewer Function

## Displaying the Memory Viewer screen

Press  to select the **MEMORY VIEWER** input.

If “INPUT (MEMORY VIEWER)” has been assigned to a FUNCTION button, simply pressing it can switch the input to MEMORY VIEWER. (see page 51)

The thumbnails or the file list is displayed.

You can switch the display between the thumbnail view and file list view by setting “Setup” - “Memory Viewer Settings”. (see page 52)

### Thumbnail view

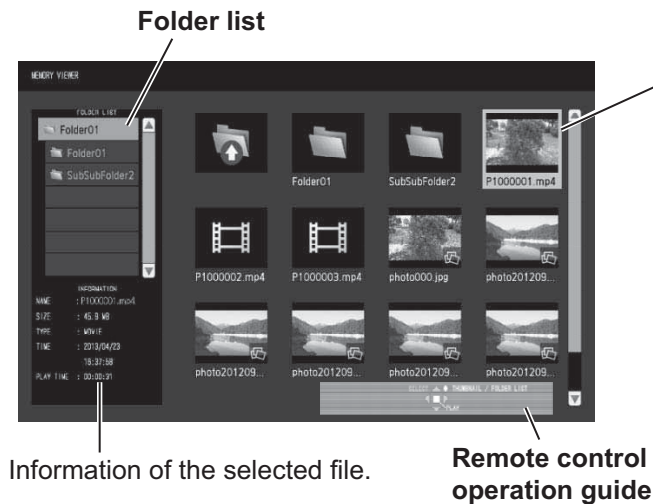

### Thumbnails

Folders, pictures and videos in the folder.  
The following icons will be displayed.



Moves to the upper level when selected.



Moves to the lower level when selected.



Picture file.



Video file.



The file has a supported extension but cannot be played.

### File list view

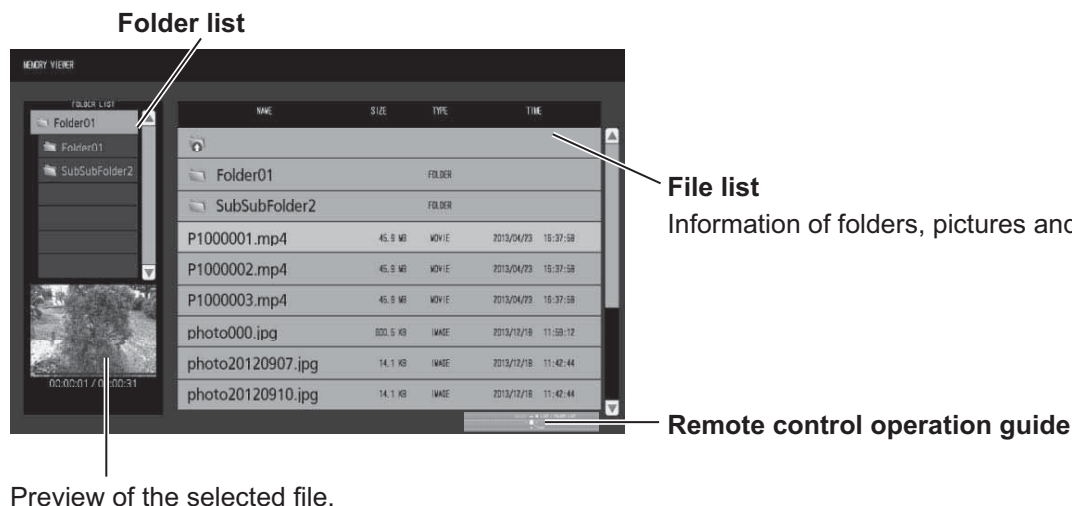

### Exiting Memory Viewer

Exit Memory Viewer before removing the USB memory.



## Playing the pictures

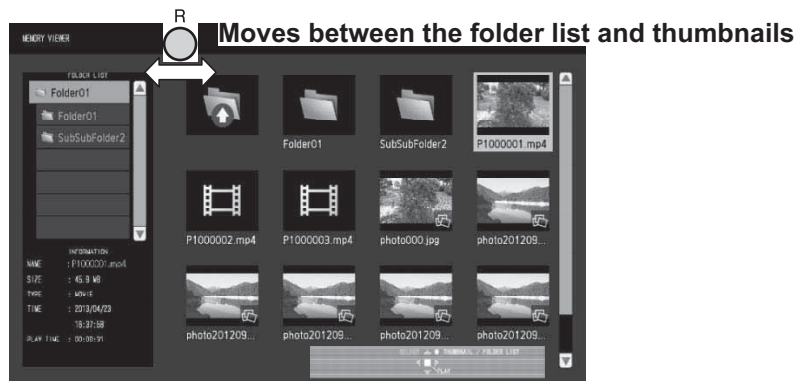

Select a file in the same manner in the file list view.

### Folder list

- 1 Press **▲▼** to select the desired folder.

The selected folder opens.

### Thumbnails / File list

- 2 Press **▲▼◀▶** to select the desired file.

Press **Ⓜ** to return to the folder list.

- 3 Press **■**.

The picture will be displayed on the full screen.



### Remote control operation guide

Press the remote control buttons to perform the following operations.

- ◀ Skip to the previous file
- ▶ Skip to the next file
- ▲ Rotate the picture clockwise (90°)
- ▼ Rotate the picture counterclockwise (90°)
- Stop temporarily or restart the Auto Play
- Ⓜ Return to the thumbnail view or file list view

### When [Auto Play] is set to [On]

All pictures in the same folder will be played automatically.

Pressing **■** during Auto Play will stop the play temporarily. Press it again to restart the play.

Pressing **◀** during Auto Play will start the play from the previous picture and pressing **▶** from the next picture.

You can set the Auto Play interval and screen-switching effect in "Setup" - "Memory Viewer Settings".

(see page 52)

- 4 Press **Ⓜ**.

The display returns to the thumbnail view or file list view.

# Memory Viewer Function

## Playing the video

Select the desired file in the same manner as "Playing the pictures". (see page 31)

### Folder list

**1 Press ▲▼ to select the desired folder.**

The selected folder opens.

### Thumbnails / File list

**2 Press ▲▼◀▶ to select the desired file.**

Press  to return to the folder list.

**3 Press .**

The video will be displayed on the full screen.









Time bar

Fast-forward / Rewind / Pause indication

### Remote control operation guide

Press the remote control buttons to perform the following operations.

-  Rewind (3 steps)  
Skip back to the previous file (during a pause)
-  Fast forward (3 steps)  
Skip to the next file (during a pause)
-  Play from the beginning
-  Pause / Restart playing
-  Return to the thumbnail view or file list view

Pressing  during play will rewind and  will fast-forward the video. The speed changes in three steps each time you press the button.

### When [Auto Play] is set to [On]

All videos in the same folder will be played automatically.

When the last file ends, Auto Play starts from the first file again.

**4 Press .**

The display returns to the thumbnail view or file list view.

## Resume play

If you stop the video on the way and play it again, the play starts from the stopped position.



The video is being played

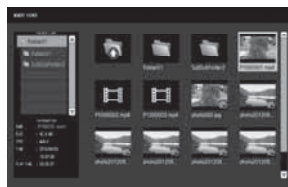

The screen returns to the thumbnail view or file list view



The play starts from the last stopped position

### Notes:

- The resume function is enabled when [Auto Play] is set to [Off]. (see page 52)
- The resume position is held until the display is turned off or the USB memory is disconnected. Up to 50 files can hold the resume position.

# Using Miracast(TM)

The function allows the image shown on the smartphone or tablet device to be sent and displayed on the display.

## **1 Select the Miracast(TM) input.**

The display switches to the [Miracast(TM)] screen and the standby screen will be displayed.

## **2 Start the Miracast application on the Miracast-compatible device or computer**

Connect the device of the name shown on the display.

The name of the Miracast application and how to start it may differ depending on the device model.

For how to use the Miracast application, see the instruction manual of your device.

## **3 Select “OK” in the connected device authentication screen**

The image on the connected device will be displayed.

### **Notes:**

- This function can be used with Miracast-compatible Android devices and WiDi compatible computers.
- The Miracast function will be disabled if “Wireless LAN” of “Network Settings” is set to “Off”.
- If [Display Name] includes a space, the characters after the space may not be displayed on some device models.
- If you have any problem in Miracast connection, see “When using Miracast” on page 68.

# On-Screen Menu Displays

## Remote Control

## Unit

### 1 Display the menu screen.



Press to select.  
(Example: Picture menu)



2 Press.

1 Press several times.

### 2 Select the item.

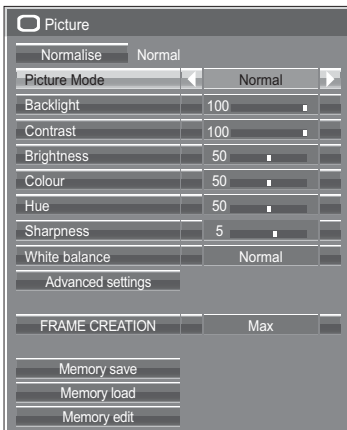

(Example: Picture menu)

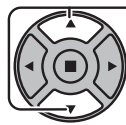

Select.



2 Press.

1 Select.

### 3 Set.



Set.



2 Press.

1 Adjust.

### 4 Exit the menu.



Press.  
Press to return to the previous menu.



Press several times.

## Menu display list

**Note:** Menu that cannot be adjusted is grayout. Adjustable menu changes depending on signal, input and menu setting.

### Picture menu

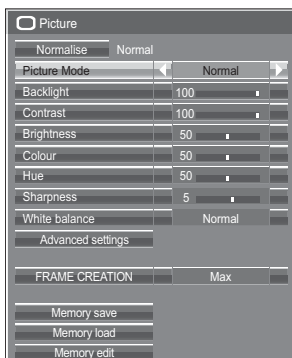

see page 38-42

### Setup menu

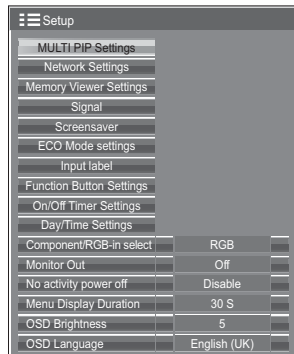

see page 44-57

### Pos./Size menu

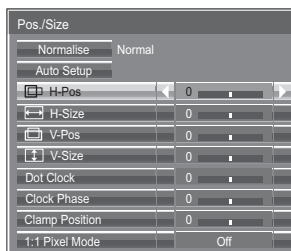

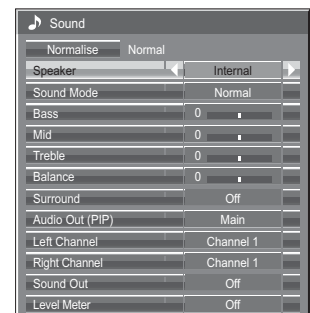

see page 35-37

### Sound menu

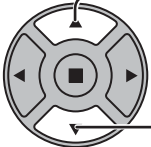
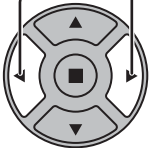

see page 43

# Adjusting Pos./Size

- 1  Press to display the Pos./Size menu.
- 2  Press to select the menu to adjust.
- 3  Press to adjust the menu.
- 4  Press to exit from adjust mode.

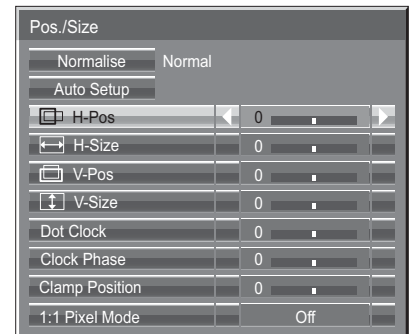

**Note:**

Unadjustable items are grayed out. Adjustable items differ depending on the input signal and the display mode.

**Notes:**

- Pos./Size cannot be adjusted with two screen display.
- Adjustment details are memorized separately for different input signal formats (Adjustments for component signals are memorized for 525 (480) / 60i · 60p, 625 (575) / 50i · 50p, 1125 (1080) / 60i · 50i · 60p · 50p · 24p · 25p · 30p · 24psF, 1250 (1080) / 50i, 750 (720) / 60p · 50p each, and RGB/PC/Digital signals are memorized for each frequency.)
- If a “Cue” or “Rew” signal from a VCR or DVD player is received, the picture position will shift up or down. This picture position movement cannot be controlled by the Picture Pos./Size function.

**Auto Setup**

When inputting a PC signal as an example, “H-Pos/V-Pos”, “H-Size/V-Size”, “Dot Clock” and “Clock Phase” are automatically corrected.

This setting is enabled under the following conditions:

- When inputting an analog signal (Component/PC):  
This setting is enabled if “Component/RGB-in select” (see page 54) in Setup menu is “RGB”.
- When inputting a digital signal (HDMI/DVI):  
A PC format signal enables this setting.

When the signal is not PC format, this setting is enabled only if “Over Scan” (see page 36) is “Off” or “1:1 Pixel Mode” (see page 37) is “On”. “H-Size/V-Size” is not automatically adjusted.

This setting will be invalid and will not work under the following conditions:

- When one of the following inputs is selected  
Miracast(TM), MEMORY VIEWER, Panasonic APPLICATION
- When VIDEO signal input
- During two screen or Digital Zoom.
- Aspect is set to “Just”
- “Display size” in the Options menu (see page 59) is set to “On”

**Using Remote Control**



When  on the remote control is pressed, “Auto Setup” will be executed.

When Auto Setup does not work, “Invalid” is displayed.

**Auto mode**

When the “Auto Setup” is set to “Auto” in the Options menu (see page 60), automatic position adjustment starts:

- When the display power is turned ON.
- When the input signal is switched.

# Adjusting Pos./Size

**Notes:**

- If the dot clock frequency of an analog signal is 162 MHz or higher, “Dot Clock” and “Clock Phase” cannot be automatically corrected.
- When digital signal input, Dot Clock and Clock Phase cannot be made.
- Auto Setup may not work when a cropped or dark image is input. In such case, switch to a bright image with borders and other objects are clearly shown, and then try auto setup again.
- Depending on the signal, out of alignment may occur after Auto Setup. Carry out fine tuning for the position/size as required.
- If Auto Setup cannot set properly for vertical frequency 60Hz XGA signal (1024×768@60Hz, 1280×768@60Hz, and 1366×768@60Hz), pre-selecting the individual signal in “XGA Mode” (see page 55) may results in correct Auto Setup.
- Auto Setup does not work well when a signal such as additional information is superimposed out of valid image period or intervals between synchronizing and image signals are short, or for image signal with tri-level synchronizing signal added.
- If Auto Setup cannot adjust correctly, select “Normalise” once and press ACTION (■), then adjust Pos./Size manually.

**H-Pos**

Adjust the horizontal position.

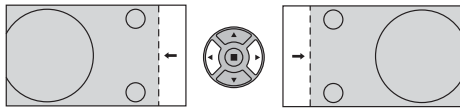

**V-Pos**

Adjust the vertical position.

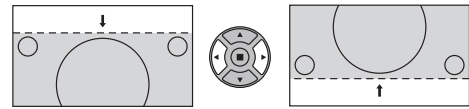

**H-Size**

Adjust the horizontal size.

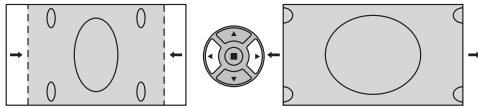

**V-Size**

Adjust the vertical size.

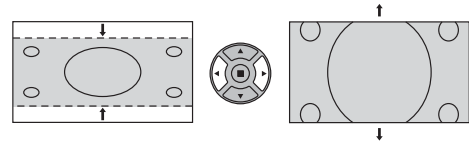

**Dot Clock (During Component/PC input signal)**

Periodic striped pattern interference (noise) may occur when a striped pattern is displayed. If this happens, adjust so that any such noise is minimized.

**Clock Phase (During Component/PC input signal)**

Eliminate the flickering and distortion.

**Over scan Turn image over scan On/Off.**

Configurable signals are as follows:

525i, 525p, 625i, 625p, 750/60p, 750/50p (Component Video, RGB, DVI, SDI, HDMI)

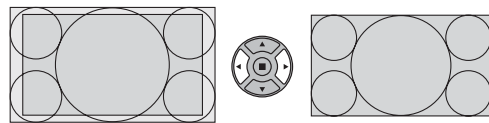

On

Off

**Notes:**

- When “Off” is set, “H-Size” and “V-Size” cannot be adjusted.
- When the “Display size” is set to “On” in the Options menu, this setting will be invalid. (see page 59)

## Clamp Position (During Component/PC input signal)

Adjusts the clamp position when black parts of the image have no detail due to underexposure or are tinged with green.

### Optimum value for Clamp Position adjustment

When black parts have no detail due to underexposure (blackout)

→ Value that causes least blackout is the optimum.

When black parts are tinged with green

→ Value that cancels the greenishness without causing blackout is the optimum.

## 1:1 Pixel Mode Adjusts the display size when 1125i, 1125p or 1250i signal is input.

### Notes:

- Select On when you would like to replay 1920 × 1080 input signal.
- Applicable input signal;  
1125 (1080) / 50i · 60i · 24psF · 24p · 25p · 30p · 50p · 60p, 1250 (1080) / 50i
- Select Off when flickering is shown around the image.
- H-Size and V-Size cannot be adjusted when On is selected.

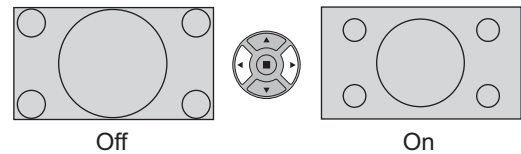

## 1:1 Pixel Mode (2k1k) When the input signal is a 2k1k signal (2048 × 1080 / 24p, 2048 × 1080 / 24psF), the display size is adjusted as follows. (For 2k1k signals)

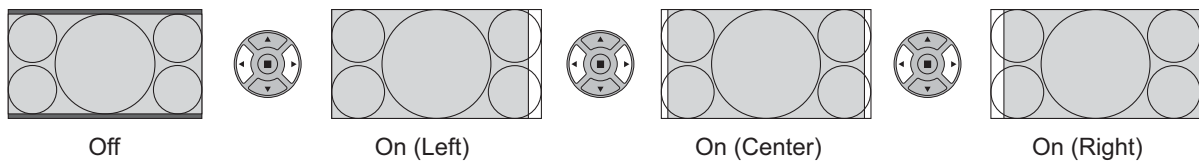

### Note:

2k1k signals can only be received when the Dual Link HD-SDI Terminal Board (TY-FB11DHD) is installed.

## Helpful Hint ( / Normalisation)

While the Pos./Size display is active, if either the N button on the remote control is pressed at any time or the ACTION () button is pressed during "Normalise", then all adjustment values are returned to the factory settings.

# Picture Adjustments

**1**  Press to display the Picture menu.

**2** Select to adjust each item.

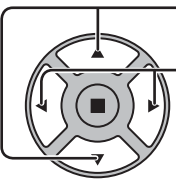
 Press to select the menu to adjust.

Select the desired level by looking at the picture behind the menu.

**Note:**  
Menu that cannot be adjusted is grayout. Adjustable menu changes depending on signal, input and menu setting.

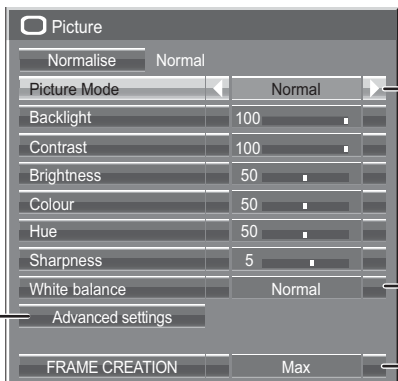

Press “◀” or “▶” button to switch between modes.

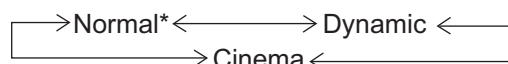

**Normal**

For viewing in standard (evening lighting) environments. This menu selects the normal levels of Brightness and Contrast.

\* In “ENGLISH (US)” OSD language, this is displayed as “STANDARD”.

**Dynamic**

For viewing in brighter environments. This menu selects higher than normal levels of Brightness and Contrast.

**Cinema**

For use in viewing tone-focused pictures with brightness reduced.

**Notes:**

- If you would like to change the picture and colour of the selected Picture menu to something else, adjust using the items in the Picture menu. (see next page)
- In “ENGLISH (US)” OSD language, the “Picture Mode” is displayed as “PICTURE MENU”.

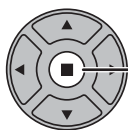

Press to enter Advanced settings.

**Advanced settings**

Enables fine picture adjustment at a professional level (see next see page).

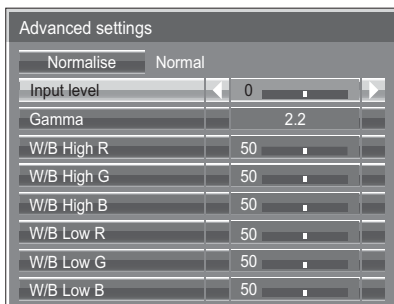

Press “◀” or “▶” button to switch between modes.

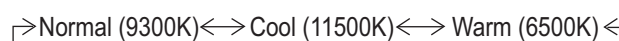

• In “ENGLISH (US)” OSD language, the “White balance” is displayed as “COLOR TEMP”.

**FRAME CREATION**

Improves motion picture quality by reducing motion blur. Press the left ◀ or right ▶ button to switch between modes.















**Notes:**

- The mode is memorized per input terminal.
- Even if “Normalise” is selected, the Normal setting will not be restored.
- The picture and menu will disappear for a moment if you switch the mode to Off, or switch from Off to another mode.

**Helpful Hint** (  /  **Normalisation**) (except “FRAME CREATION”)

While the “Picture” menu is displayed, if either the N button on the remote control is pressed at any time or the ACTION (  ) button is pressed during “Normalise”, then all adjustment values are returned to the factory settings.



















Item	Effect	Adjustments
<b>Backlight</b>	 Darker  Brighter	Adjusts luminance of the back light.
<b>Contrast*</b>	 Less  More	Selects the proper brightness and density for the room.
<b>Brightness</b>	 Darker  Brighter	Adjusts for easier viewing of dark pictures such as night scenes and black hair.
<b>Colour</b>	 Less  More	Adjusts colour saturation.
<b>Hue</b>	 Reddish  Greenish	Adjusts for nice skin colour.
<b>Sharpness</b>	 Less  More	Adjusts picture sharpness.

**Notes:**

- You can change the level of each function (Contrast, Brightness, Colour, Hue, Sharpness) for each Picture Mode.
- The setting details for Normal, Dynamic and Cinema respectively are memorized separately for each input terminal.
- “Backlight” can be adjusted when “ECO Mode” is set to “Custom” and “Power save” to “Off”. (see page 49)

\* In “ENGLISH (US)” OSD language, this is displayed as “PICTURE”.

## Advanced settings

Item	Effect	Details
<b>Input level</b>	 Less  More	Adjustment of parts which are extremely bright and hard to see.
<b>Gamma</b>	 Down  Up	S Curve $\longleftrightarrow$ 2.0 $\longleftrightarrow$ 2.2 $\longleftrightarrow$ 2.6
<b>W/B High R</b>	 Less  More	Adjusts the white balance for light red areas.
<b>W/B High G</b>	 Less  More	Adjusts the white balance for light green areas.
<b>W/B High B</b>	 Less  More	Adjusts the white balance for light blue areas.
<b>W/B Low R</b>	 Less  More	Adjusts the white balance for dark red areas.
<b>W/B Low G</b>	 Less  More	Adjusts the white balance for dark green areas.
<b>W/B Low B</b>	 Less  More	Adjusts the white balance for dark blue areas.

**Notes:**

- Advanced settings cannot be adjusted with two screen display.
- Carry out “W/B” adjustment as follows.
  1. Adjust the white balance of the bright sections using the “W/B High R”, “W/B High G” and “W/B High B” settings.
  2. Adjust the white balance of the dark sections using the “W/B Low R”, “W/B Low G” and “W/B Low B” settings.
  3. Repeat steps 1 and 2 to adjust.
 Steps 1 and 2 affect each other’s settings, so repeat each step in turn to make the adjustment.
- The adjustment values are memorized separately for each input terminal.
- The adjustment range values should be used as an adjustment reference.

### Helpful Hint ( / Normalisation )

On the remote control unit, while the “Advanced settings” menu is displayed, if either the N button is pressed at any time or the ACTION (  ) button is pressed during “Normalise”, then all adjustment values are returned to the factory settings.

# Picture Profiles

Up to 8 combinations of picture adjustment values (in the Picture menu and Advanced settings) can be stored in the display memory as profiles and applied as needed, for a convenient way to enjoy your preferred picture settings.

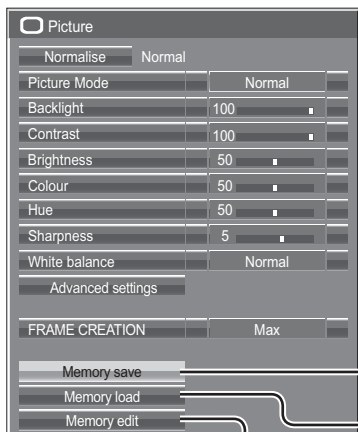

Save profiles (page 41)

Load profiles (page 42)

Edit profiles (page 42)

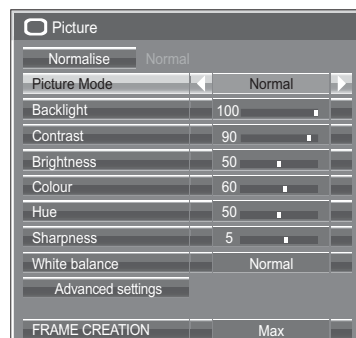

Save profiles

Save the picture adjustment values in the MEMORY1 profile

Edit the profile  
Delete or rename the profile

MY PICTURE  
MEMORY2  
MEMORY3  
MEMORY4  
...  
MEMORY8

MEMORY1  
MEMORY2  
MEMORY3  
MEMORY4  
...  
MEMORY8

Load the profile

Apply the MEMORY1 profile

Original picture



Custom picture

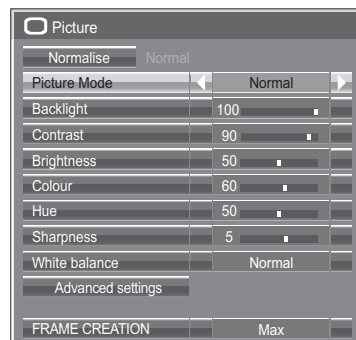
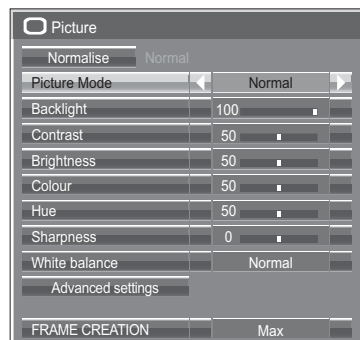

# Saving profiles

Follow these steps to save picture adjustment values as profiles.

**1** Specify the picture quality in the Picture menu and Advanced settings. (see page 38, 39)

**2** In the Picture menu, select “Memory save”.



**3** Select a profile name for saving the picture adjustment values.

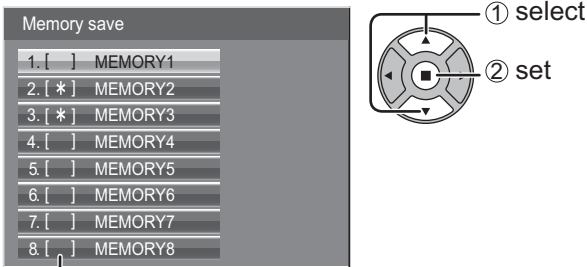

“\*” appears for a profile in which the picture adjustments have already been saved.

**4** Select “Ok”.



**5** Enter a name for the profile.

**[Entering profile names]**

Profile names can be up to 40 characters.

To enter text, select characters in the on-screen keyboard.

Edit the default profile name in the text box as desired.

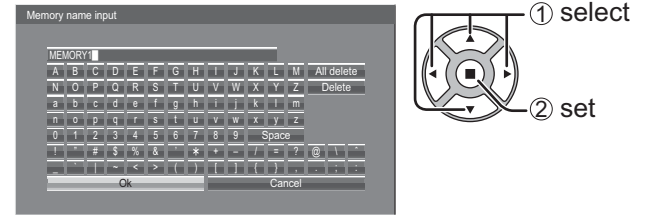

**Example: Specifying “MY PICTURE”**

① Select “All delete”.



All text is deleted.

To delete individual characters, select “Delete”.

② Select “M”.



Repeat this process to enter the next character.

③ Select “Y”.



④ Select “Space”.



**6** When you finished entering the profile name, select “Ok”.

To cancel saving the profile, select “Cancel”.

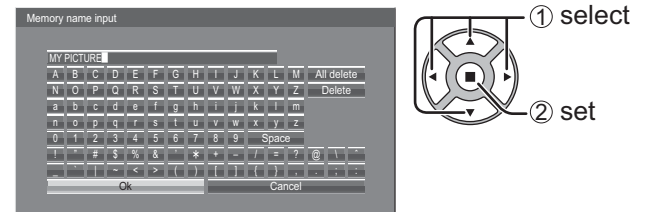

## Loading profiles

Load profiles and apply the picture adjustment values to the display as follows.

**Note:**

Loaded profiles are stored in memory according to the selected input terminal. (see page 21)

**1** In the Picture menu, select "Memory load".



**2** Select the profile to load.

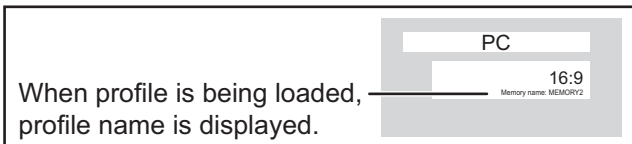

## Editing profiles

Delete or rename profiles as follows.

**<Deleting profiles>**

**1** In the Picture menu, select "Memory edit".



**2** Select "Memory delete".



**3** Select the profile to delete.  
To delete all profiles, select "All delete".



**4** Select "Ok".

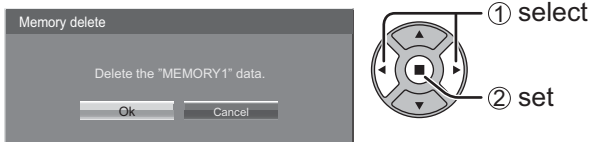

**<Renaming profiles>**

**1** In the Picture menu, select "Memory edit".



**2** Select "Memory name change".



**3** Select the profile to rename.



**4** Enter a name for the profile.  
Entering profile names → page 41

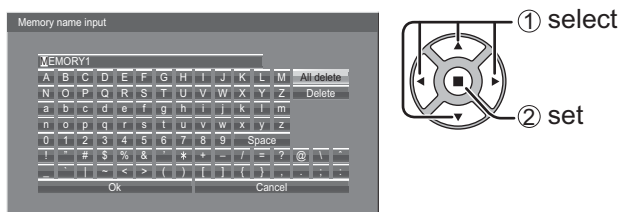

**5** When you finished entering the profile name, select "Ok".

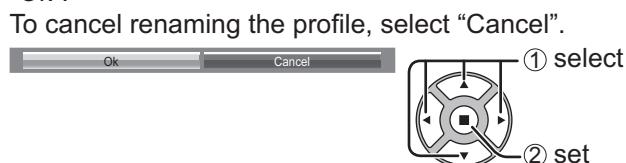

# Sound Adjustment

**1**  Press to display the Sound menu.

**2** Select to adjust each item.

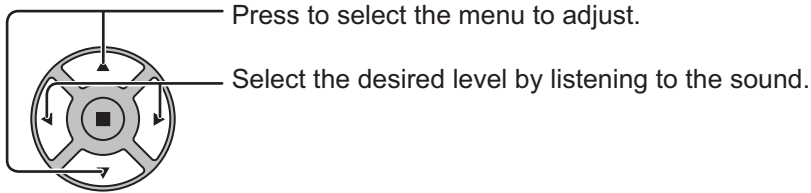

**3**  Press to exit from adjust mode.

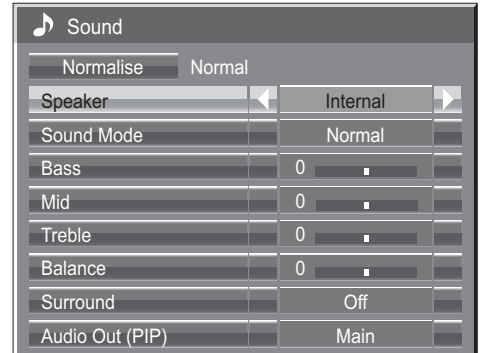

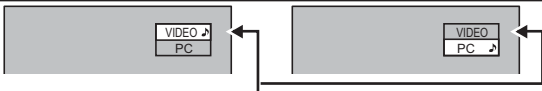
Item	Details
<b>Speaker</b>	Select the audio output. <b>Internal:</b> Internal speakers <b>External:</b> External speakers
<b>Sound Mode</b>	<b>Normal:</b> Emits the original sound. <b>Dynamic:</b> Accentuates sharp sound. <b>Clear:</b> Attenuates human voice.
<b>Bass</b>	Adjusts low pitch sounds.
<b>Mid</b>	Adjusts normal sounds.
<b>Treble</b>	Adjusts high pitch sounds.
<b>Balance</b>	Adjusts left and right volumes.
<b>Surround</b>	Select On or Off.
<b>Audio Out (PIP)</b>	<b>Main:</b> Selects main picture sound. <b>Sub:</b> Selects PIP frame sound.  Musical note ♪ is displayed on right side of the audio output screen label.

**Note:** Bass, Mid, Treble and Surround settings are memorized separately for each Sound Mode.

## Helpful Hint ( / **Normalise** Normalisation )

While the “Sound” menu is displayed, if either the N button on the remote control is pressed at any time or the ACTION (  ) button is pressed during “Normalise”, then all adjustment values are returned to the factory settings.

## SDI Sound Output



This menu is available only when selecting a slot that any of the following terminal boards is installed:  
HD-SDI Terminal Board with audio (TY-FB10HD) or Dual Link HD-SDI Terminal Board (TY-FB11DHD)



**Note:**  
This menu is unavailable when two screen display mode is active.

Item	Details
<b>Left Channel</b>	<b>Channel 1 to Channel 16</b> Selects left audio channel.
<b>Right Channel</b>	<b>Channel 1 to Channel 16</b> Selects right audio channel.
<b>Sound Out</b>	<b>On</b> $\longleftrightarrow$ <b>Off</b> <b>On:</b> Enables audio output. <b>Off:</b> Disables audio output.
<b>Level Meter</b>	<b>Off</b> $\longleftrightarrow$ <b>1-8ch</b> $\longleftrightarrow$ <b>9-16ch</b> Sets audio channels to show in the audio level meter. 8 channels are displayed in the audio level meter; 4 channels each on both right and left sides of the display. <b>Off:</b> Hides the audio level meter. <b>1-8ch:</b> Displays the audio level meter (1-8ch) <b>9-16ch:</b> Displays the audio level meter (9-16ch)

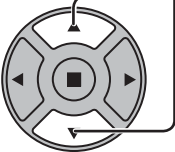
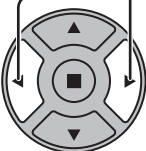
# Setup menu

- 1  Press to display the Setup menu.
- 2  Press to select the menu to adjust.
- 3  Press to adjust the menu.
- 4  Press to exit from adjust mode.

Press  to return to the previous menu.

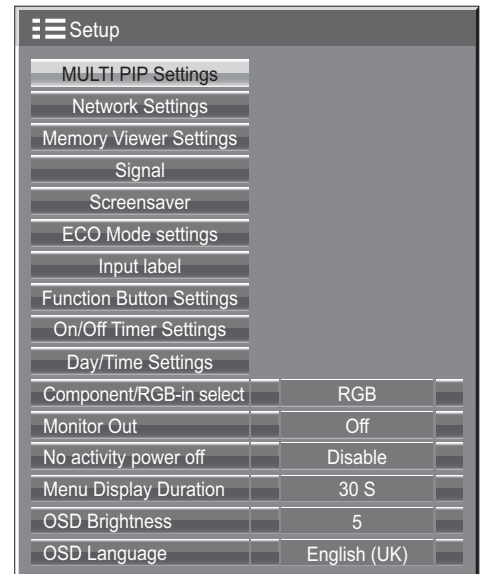

## Setup menu screen

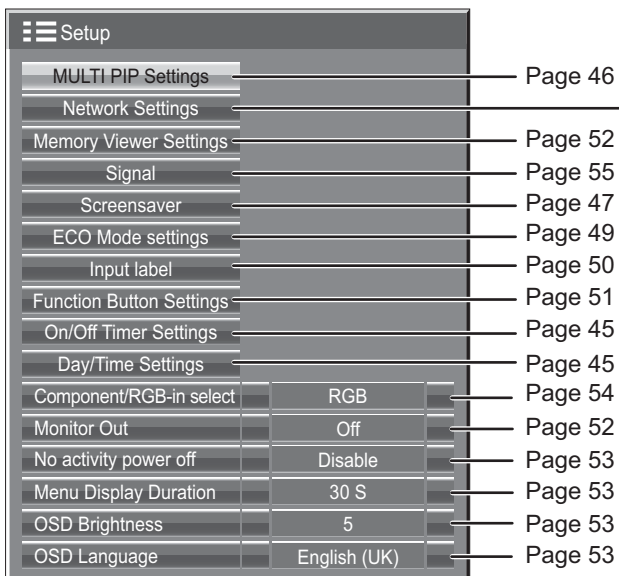

### Network Settings

Set this to connect the Display to a computer via a network. For details of PLink and Network, refer to "Operating Instructions, Network Operations".

# Day/Time Settings / On/Off Timer Settings

The timer can switch the Display On or Off.

Before attempting Timer Set, confirm the Time and adjust if necessary.  
Then set POWER ON Time / POWER OFF Time.

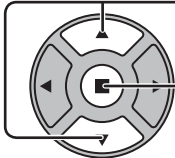
-  Press to display the Setup menu.
- 
  - Press to select On/Off Timer Settings or Day/Time Settings.
  - Press to display the On/Off Timer Settings screen or Day/Time Settings screen.

## Day/Time Settings

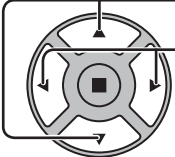
- 
    - Press to select Day or Time.
    - Press to setup Day or Time.
      - ▶ button: Forward
      - ◀ button: Back

**Notes:**

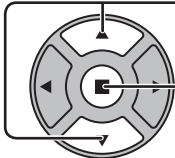
    - Pressing “◀” or “▶” button once changes Time 1 minute.
    - Pressing “◀” or “▶” button continuously changes Time by 15 minutes.
- | Day/Time Settings |           |
|-------------------|-----------|
| Time              | MON 99:99 |
| Set               |           |
| Day               | MON       |
| Time              | 99:99     |
- 
    - Press to select Set.
    - Press to store Day/Time Settings.

**Notes:**

    - Set cannot be selected unless Time is set.
    - Unless setting the present time other than “99:99”, “Day” and “Time” cannot be set.
    - The settings of “Day” and “Time” are reset when leaving the display turned off for about 7 days for the following reasons:
      - Pressing ⏻/| switch of the unit to turn off the display.
      - Disconnecting the AC cord.
      - Interruption of power supply.

## On/Off Timer Settings

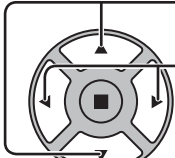
- 
    - Press to select POWER ON Time / POWER OFF Time.
    - Press to setup POWER ON Time / POWER OFF Time.
      - ▶ button: Forward
      - ◀ button: Back

**Notes:**

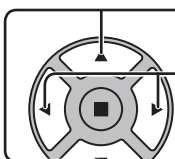
    - Pressing “◀” or “▶” button once changes POWER ON Time / POWER OFF Time 1 minute.
    - Pressing “◀” or “▶” button continuously changes POWER ON Time / POWER OFF Time by 15 minutes.
- | On/Off Timer Settings |       |
|-----------------------|-------|
| Time                  | 99:99 |
| POWER ON Function     | Off   |
| POWER ON Time         | 0:00  |
| POWER OFF Function    | Off   |
| POWER OFF Time        | 0:00  |
- 
    - Press to select POWER ON Function/POWER OFF Function.
    - Press to select On.

**Note:** Timer function will not work unless “Time” is set.

# MULTI PIP Settings

Set the two screen display function.

Two screen display function ➔ MULTI PIP (page 27)

Select "MULTI PIP Settings" in "Setup" menu and press  button.

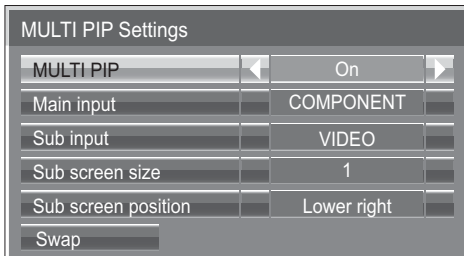

## **MULTI PIP**

Set this "ON" to have two screen display. Various settings such as "PIP Mode" can be set.

## **Main input**

Sets the input image for the main screen.

## **Sub input**

Sets the input image for the sub screen.

## **Sub screen size**

1 (small) - 4 (large): Sets the size of the sub screen.

## **Sub screen position**

Sets the display position of the sub screen.

## **Swap**

Swap the main and sub screens.



# Screensaver (For preventing image retention)

Do not display a still picture, especially in 4:3 mode, for any length of time.  
If the display must remain on, a Screensaver should be used.

**1** Select "Screensaver" in "Setup" menu and press  button.

## 2 Function selection

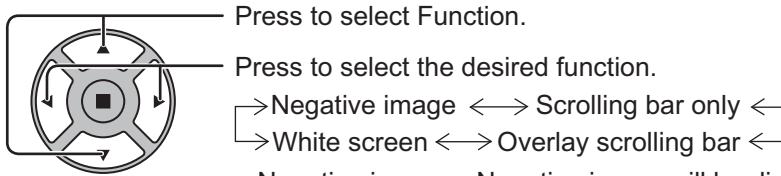

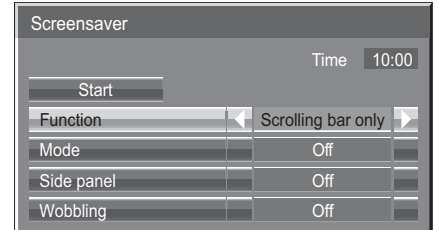

- Negative image : Negative image will be displayed on the screen.
- Scrolling bar only : A white bar will scroll from left to right. The image won't be displayed.
- Overlay scrolling bar : The brightness of the image will be decreased and a white bar will scroll on it.
- White screen : The whole screen will be white.

**Note:** Overlay scrolling bar is not effective during two screen display.

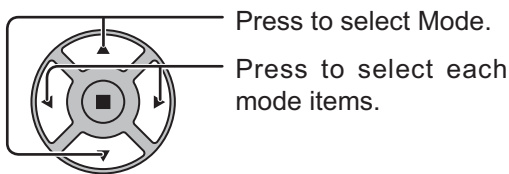

## 3 Mode selection



- Standby after SCR Saver: Operates while Screensaver duration, and display enters standby mode.
- On : Operates when Start is selected and the ACTION () button is pressed.
- Off
- Interval : Operates when Periodic Time and Operating Time are setup and those times arrive.
- Time Designation : Operates when Start Time and Finish Time are setup and those times arrive.

## 4 Start setting

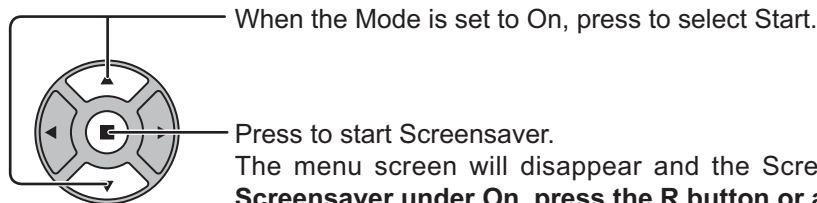

The menu screen will disappear and the Screensaver will be activated. **To stop the Screensaver under On, press the R button or any buttons on the main unit.**

**Note:** When the display is turned off, the Screensaver will be deactivated.

## Setup of Screensaver Time

After selecting Time Designation, Interval or Standby after SCR Saver, the relevant Time Setup will become available for selection and the Operating Time may be set. (Time cannot be set when "Mode" is "On" or "Off".)

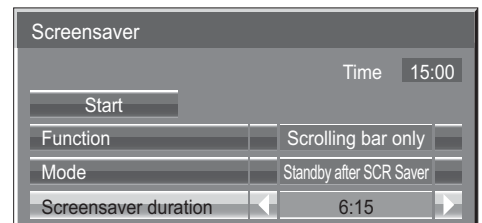
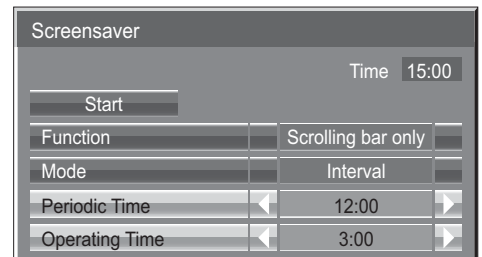
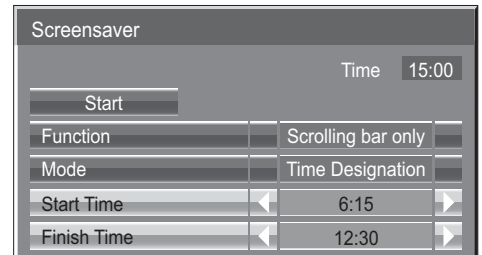
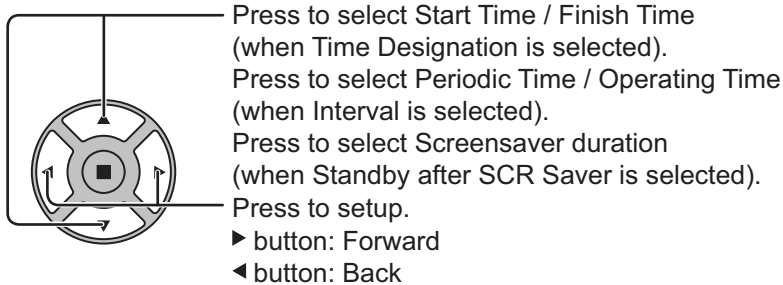

### Notes:

- Pressing "◀" or "▶" button once changes the Time 1 minute. [However, switching occurs every 15 minutes when Periodic Time is selected.]
- Pressing "◀" or "▶" button continuously changes the Time by 15 minutes.
- "Screensaver duration" of the "Standby after SCR Saver" can be set from 0:00 to 23:59. When this is set to "0:00", "Standby after SCR Saver" will not be activated.

**Note:** Timer function will not work unless "Time" is set.

### Side panel

Do not display a picture in 4:3 mode for an extended period, as this can cause an image retention to remain on the side panels on either side of the display field. To reduce the risk of such an image retention, illuminate the side panels.

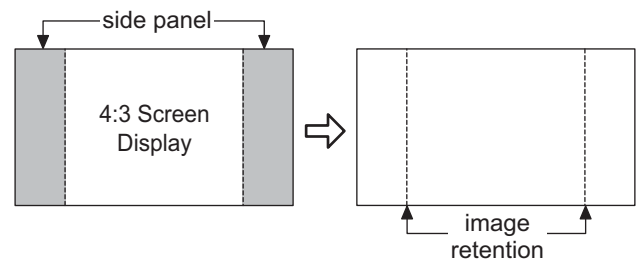

This function may be applicable to the non-picture area.

- Off:** Darken both ends.
- Low:** Make it dark gray.
- Mid:** Make it gray.
- High:** Make it light gray.

### Note:

To reduce the occurrence of image retention, set the Side panel to High.

### Wobbling

Automatically shifts the display image (therefore unnoticeable to the eye) to prevent image retention of sharper contour of image.

### Note:

When this function is operating, part of the screen may appear to be missing.



# Customizing the Input labels

This function can change the label of the Input signal to be displayed. (see page 21)

Select "Input label" in "Setup" menu and press  button.

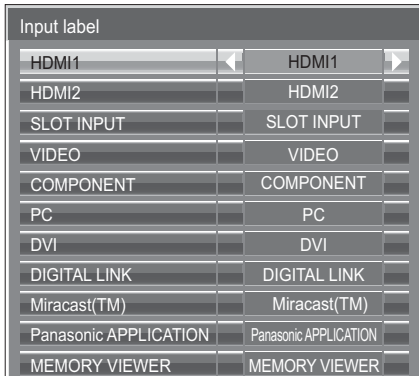

Image input	Input label
[HDMI1]	HDMI1 / DVD1 / DVD2 / DVD3 / DVD4 / Blu-ray1 / Blu-ray2 / Blu-ray3 / Blu-ray4 / CATV / VCR / STB / (Skip)
[HDMI2]	HDMI2 / DVD1 / DVD2 / DVD3 / DVD4 / Blu-ray1 / Blu-ray2 / Blu-ray3 / Blu-ray4 / CATV / VCR / STB / (Skip)
[SLOT INPUT]*1	SLOT INPUT / DVD1 / DVD2 / DVD3 / DVD4 / Blu-ray1 / Blu-ray2 / Blu-ray3 / Blu-ray4 / CATV / VCR / STB / (Skip)
[VIDEO]	VIDEO / DVD1 / DVD2 / DVD3 / DVD4 / Blu-ray1 / Blu-ray2 / Blu-ray3 / Blu-ray4 / CATV / VCR / STB / (Skip)
[COMPONENT]*2	COMPONENT / DVD1 / DVD2 / DVD3 / DVD4 / Blu-ray1 / Blu-ray2 / Blu-ray3 / Blu-ray4 / CATV / VCR / STB / (Skip)
[PC]	PC / DVD1 / DVD2 / DVD3 / DVD4 / Blu-ray1 / Blu-ray2 / Blu-ray3 / Blu-ray4 / CATV / VCR / STB / (Skip)
[DVI]	DVI / DVD1 / DVD2 / DVD3 / DVD4 / Blu-ray1 / Blu-ray2 / Blu-ray3 / Blu-ray4 / CATV / VCR / STB / (Skip)
[DIGITAL LINK]	DIGITAL LINK / (Skip)
[Miracast(TM)]	Miracast(TM) / (Skip)
[Panasonic APPLICATION]	Panasonic APPLICATION / (Skip)
[MEMORY VIEWER]	MEMORY VIEWER / (Skip)

(Skip): The INPUT button press will skip its input.

\*1 "SLOT INPUT" is displayed when a Terminal Board is installed.

\*2 "COMPONENT" may be displayed as "RGB" depending on the setting of "Component/RGB-in select". (see page 54)

## When a Terminal Board with dual input terminals is installed

"SLOT INPUT" is displayed as "SLOT INPUT A" and "SLOT INPUT B" and independent settings are available.

[SLOT INPUT A]	SLOT INPUT A / DVD1 / DVD2 / DVD3 / DVD4 / Blu-ray1 / Blu-ray2 / Blu-ray3 / Blu-ray4 / CATV / VCR / STB / (Skip)
[SLOT INPUT B]	SLOT INPUT B / DVD1 / DVD2 / DVD3 / DVD4 / Blu-ray1 / Blu-ray2 / Blu-ray3 / Blu-ray4 / CATV / VCR / STB / (Skip)

## When a Terminal Board with fixed display (such as Tuner Board) is installed

Only fixed display and (Skip) are available as Input label of "SLOT INPUT".

[SLOT INPUT]	<span style="border: 1px solid black; padding: 2px;">fixed display</span> / (Skip)
--------------	--

# Function Button Settings

Set the functions that operates when <sup>FUNCTION</sup> **1** **2** is pressed.

Select "Function Button Settings" in "Setup" menu and press  button.

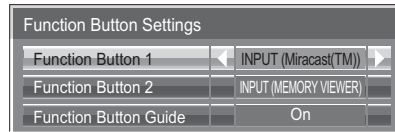

## • Function Button 1, Function Button 2

The following functions are set to the FUNCTION button.

### Note:

Factory settings are as follows.

FUNCTION1 button: INPUT (Miracast(TM))

FUNCTION2 button: INPUT (MEMORY VIEWER)

## ECO Mode settings / Signal / On/Off Timer Settings / MULTI PIP Settings

The menu is displayed. (Example: ECO Mode settings)

FUNCTION  
**1** **2**

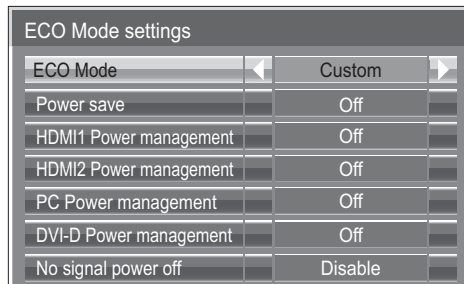

Pressing the FUNCTION button clears the menu.

## Scrolling bar

Activates the "Scrolling bar only" screensaver. After 15 minutes, the display enters standby mode.



To exit this mode, press  button.

## INPUT (SLOT)\* - INPUT (MEMORY VIEWER)

Simply press <sup>FUNCTION</sup> **1** **2** to select the input.

\* "INPUT (SLOT)" is displayed when an optional Terminal Board is installed.

When a Terminal Board with dual input terminals is installed, "INPUT (SLOT A)" and "INPUT (SLOT B)" are displayed.

## Network Settings

"Network Settings" menu is displayed.

### Note:

For the network function, refer to "Operating Instructions, Network Operations" and the instruction manual of "Wireless Manager" in use.

## Multi-Live

Switch to the Multi-Live mode when using the "Wireless Manager".

## AV Mute

Mutes the audio and video. To exit this mode, press any button.

## MULTI PIP

Press <sup>FUNCTION</sup> **1** **2** to turn MULTI PIP On/Off.

## • Function Button Guide

The function display setting for the FUNCTION button is configured.

**On:** Press the FUNCTION button to display the function list of the button.

**Off:** The function list is not displayed.

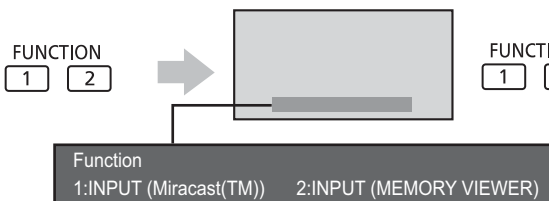

The operation starts.

# Memory Viewer Settings

Set the display styled of the Memory Viewer screen and Auto Play settings.

Select "Memory Viewer Settings" in "Setup" menu and press  button.

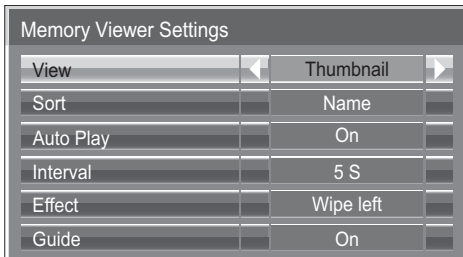

## View

Switches the thumbnail and list views.

## Sort

Name/Time/Type: Sets the sort order of the thumbnail or list files.

## Auto Play

Set to "On" to Auto Play the still pictures or videos.

## Interval

5 S - 120 S: Sets the intervals for still picture Auto Play.

## Effect

Sets the effect used when the screen is changed during Auto Play.

## Guide

Sets the remote control operation guide On/Off.

# Monitor Out

Sets the monitor output from the PC OUT terminal.

Off: Disables monitor output.

On: Enables monitor output.

**When "On" is set, the following "Picture" menu settings will be fixed to the standard values.**

Brightness: 50

Colour: 50

Hue: 50

Sharpness: 0

Advanced settings

Gamma: 2.2

# No activity power off

**Disable**  $\longleftrightarrow$  **Enable**

When this function is set to “Enable”, the power is turned off (standby) automatically when there is no operation of the Display for 4 hours.

Starting from 3 minutes before the turn off, the remaining time will be displayed.

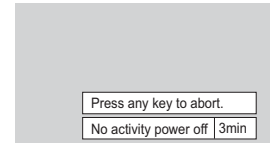

When the power is turned off due to this function, a message “Last turn off due to 'No activity power off'.” is displayed next time the power is turned on.

**Note:**

During the screensaver is running, this function is disabled.

# Menu Display Duration / OSD Brightness

Set the display time and brightness of the on-screen menu display.

**Menu Display Duration: 5 S - 30 S**

**OSD Brightness: 1 - 5**

# OSD Language

Select your preferred language.

■ Selectable languages

English(UK)

Deutsch

Français

Italiano

Español

ENGLISH(US)

中文.....(Chinese)

日本語.....(Japanese)

Русский.....(Russian)

# Setup for Input Signals

## Component / RGB-in select

---

Component  $\longleftrightarrow$  RGB

Select to match the signals from the source connected to the Component / RGB or PC input terminals.

Y, P<sub>B</sub>, P<sub>R</sub> signals  $\Leftrightarrow$  "Component"

RGB signals  $\Leftrightarrow$  "RGB"

**Note:**

Make setting of the selected input terminal (COMPONENT/RGB IN or PC IN).

---

## YUV / RGB-in select

---

YUV  $\longleftrightarrow$  RGB

Select to match the signals from the source connected to the DVI input terminals.

YUV signals  $\Leftrightarrow$  "YUV"

RGB signals  $\Leftrightarrow$  "RGB"

**Notes:**

- Selection may not be possible, depending on which optional board is installed.
- Make setting of the selected input terminal (SLOT or DVI-D IN).



## Signal menu

### Notes:

- “Signal” setup menu displays a different setting condition for each input signal.
- Depending on the input signal type, an optional Terminal Board may be required.

Select “Signal” in “Setup” menu and press  button.



### For Video (S VIDEO)

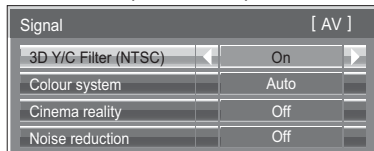

### For RGB

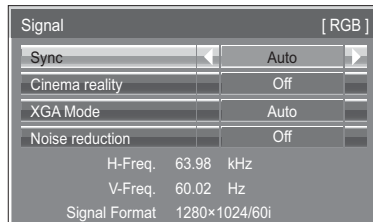

### For Component

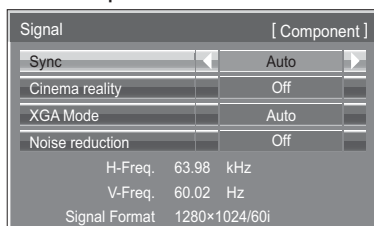

### For Digital

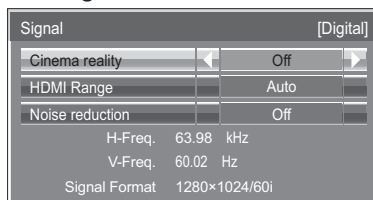

### • 3D Y/C Filter (NTSC)

This menu is displayed when BNC Dual Video Terminal Board (TY-FB9BD) is installed to the unit. Set this menu when the moving image looks unnatural during Video (S Video) input signal.

**On**  $\longleftrightarrow$  **Off**

#### Note:

When On, this setting only affects NTSC input signals.

### • Colour system

$\rightarrow$  Auto  $\longleftrightarrow$  PAL  $\longleftrightarrow$  SECAM  $\longleftrightarrow$  M.NTSC  $\longleftrightarrow$  NTSC  $\leftarrow$

Set the colour system to match the input signal. When “Auto” is set, Colour system will be automatically selected from NTSC/PAL/SECAM/M.NTSC.

To display PAL60 signal, select “Auto” or “PAL”.

#### If the picture image becomes unstable:

With the system set on Auto, under conditions of low level or noisy input signals the image may in rare cases become unstable. Should this occur, set the system to match the format of the input signal.

### • Cinema reality

When “On”, the display attempts to reproduce a more natural interpretation of sources such as movie pictures, which are recorded at 24 frames per second.

If the picture is not stable, turn the setting to “Off”.

**On**  $\longleftrightarrow$  **Off**

#### Note:

When On, this setting only affects the following signal input:

- NTSC / PAL signal input during Video (S Video) input signal.
- 525i(480i), 625i(575i), 1125(1080)/60i signal input during “Component” input signal.

### • XGA Mode

This menu is displayed when the input signal is analog (Component/PC). This unit supports three types of XGA signals with 60Hz vertical frequency having different aspect ratios and sampling rates (1,024 × 768 @ 60Hz, 1,280 × 768 @ 60Hz and 1,366 × 768 @ 60Hz).

**Auto**  $\longleftrightarrow$  **1024x768**  $\longleftrightarrow$  **1280x768**  $\longleftrightarrow$  **1366x768**

**Auto:** Automatically selected from 1024x768/1280x768/1366x768.

Switch the setting to suit the input signal for better display depends on the angle of view or display resolution condition.

#### Note:

After making this setting, be sure to make each adjustment (such as “Auto Setup”) on the “Pos./Size” menu as necessary. (see page 35)

# Setup for Input Signals

---

- **Sync**

This function operates only during input from PC IN terminal.

- **Setting RGB sync signal**

Confirm that the input is set to RGB input (this setting is valid only for RGB input signal).

**Auto:** The H and V sync or synchronized signal is automatically selected. If both input, it is selected the H and V sync.



**on G:** Uses a synchronized signal on the Video G signal, which is input from the G connector.

- **Setting Component sync signal**

Confirm that the input is set to Component input (this setting is valid only for Component input signal).

**Auto:** The H and V sync or synchronized signal is automatically selected. If both input, it is selected the H and V sync.



**on Y:** Uses a synchronized signal on the Video Y signal, which is input from the Y connector.

- **Note:**

Signals input to COMPONENT/RGB IN terminals correspond to Sync on G or Sync on Y.

- **SDI Through**

Set the active through function of the Dual Link HD-SDI Terminal Board (TY-FB11DHD).

**On** ↔ **Off**

**On:** Enables active through.

**Off:** Disables active through.

- **Note:**

Settings can only be performed for this menu when a slot mounted with a Dual Link HD-SDI Terminal Board (TY-FB11DHD) is selected.

- **HDMI Range**

Switches the dynamic range according to the input signal from HDMI terminal.

**Video(16-235)** ↔ **Full(0-255)** ↔ **Auto**

**Video(16-235):** If the input signal is the video range, Example: HDMI terminal output for DVD player

**Full(0-255):** If the input signal is full range, Example: HDMI terminal output for personal computer

**Auto:** Switches the dynamic range automatically between "Video(16-235)" and "Full(0-255)" according to the input signal.

- **Notes:**

- This function can be set only for HDMI signal input.
- "Auto" cannot be selected during the DIGITAL LINK input.

## • Noise reduction

Sets the following three NR (Noise Reduction) functions together.  
P-NR, Mosquito NR, Block NR

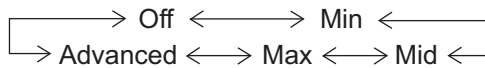

### Advanced NR

Sets the three NR functions separately.

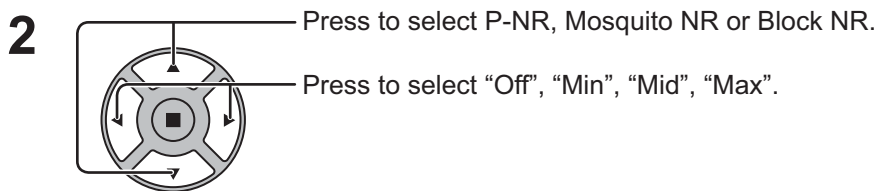
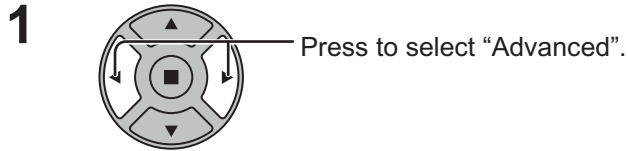

**P-NR:** Automatically reduces unwanted picture noise.

**Mosquito NR:** Reduces mosquito noise around subtitles on MPEG videos.

**Block NR:** Reduces block noise when playing MPEG videos.

#### Note:

Noise reduction cannot be adjusted while a PC signal is being applied.

## • Input signal display

Displays the frequency and the type of the current input signal.

This display is valid only for Component / RGB / PC and Digital input signal.

Display range:

Horizontal 15 - 110 kHz  
Vertical 48 - 120 Hz



H-Freq.	63.98	kHz
V-Freq.	60.02	Hz
Signal Format	1280×1024/60i	

The dot clock frequency is displayed during DVI signal input.

H-Freq.	63.98	kHz
V-Freq.	60.02	Hz
Dot Clock Freq.	108.0	MHz
Signal Format	1280×1024/60i	

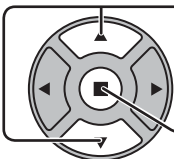
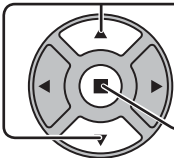
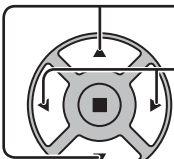

# Options Adjustments



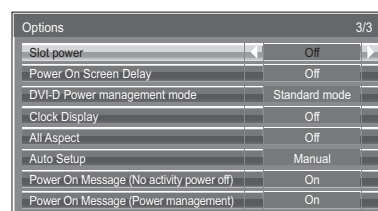
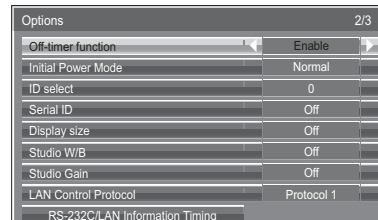
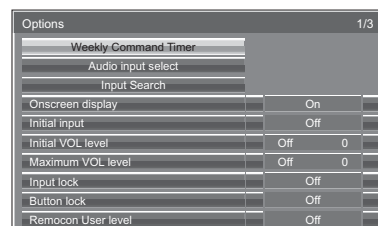
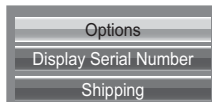



















The remote control is used for all the Options menu operations. Unit buttons cannot be used for this operation.

- 1  Press to display the Setup menu.
- 2  Press to select "OSD Language".  
Press for more than 3 seconds.
- 3  Press to select "Options".  
Press to display the Options menu.
- 4  Press to select your preferred menu.  
Press to adjust the menu.
- 5  Press to exit from Options menu.





- The serial number of this device is displayed when "Display Serial Number" is selected in step 3.

Item	Adjustments
<b>Weekly Command Timer</b>	Sets Weekly Command Timer. (see page 61)
<b>Audio input select</b>	Set up the sound when an image input is selected. (see page 63)
<b>Input Search</b>	Set auto input switching for when there is no signal. (see page 64)
<b>Onscreen display</b>	<p><b>On:</b> Displays all the following on screen.</p> <ul style="list-style-type: none"> <li>• Power on display</li> <li>• Input signal switch display</li> <li>• No signal display</li> <li>• Mute and the remaining time of off-timer after  was pressed.</li> </ul> <p><b>Off:</b> Hides all the items above from view.</p>
<b>Initial input</b>	<p>Adjusts the input signal when the unit is turned on.</p> <p><b>Off</b> ↔ <b>HDMI1</b> ↔ <b>HDMI2</b> ↔ <b>SLOT INPUT</b>*1 ↔ <b>VIDEO</b> ↔ <b>COMPONENT</b>*2 ↔ <b>PC</b> ↔ <b>DVI</b> ↔ <b>DIGITAL LINK</b> ↔ <b>Miracast(TM)</b> ↔ <b>Panasonic APPLICATION</b> ↔ <b>MEMORY VIEWER</b></p> <p>*1 "SLOT INPUT" is displayed when an optional Terminal Board is installed. When a Terminal Board with dual input terminals is installed, "SLOT INPUT A" and "SLOT INPUT B" are displayed.</p> <p>*2 "COMPONENT" may be displayed as "RGB" depending on the setting of "Component/RGB-in select". (see page 54)</p> <p><b>Notes:</b></p> <ul style="list-style-type: none"> <li>• Only the adjusted signal is displayed. (see page 21)</li> <li>• This menu is available only when "Input lock" is "Off".</li> </ul>
<b>Initial VOL level</b>	<p>Press  button to adjust the volume when the unit is turned on.</p> <p><b>Off</b> ↔ <b>On</b></p> <p><b>Off:</b> Sets normal volume.</p> <p><b>On:</b> Sets your preferred volume.</p> <p><b>Notes:</b></p> <ul style="list-style-type: none"> <li>• When "Maximum VOL level" is "On", the volume can only be adjusted between 0 and your maximum range.</li> <li>• You can hear the changed volume regardless of your volume setting before opening the options menu if you adjust the volume when "Initial VOL level" is "On" and cursor is on the menu.</li> </ul>
<b>Maximum VOL level</b>	<p>Press  button to adjust the maximum volume.</p> <p><b>Off</b> ↔ <b>On</b></p> <p><b>Off:</b> Sets auto maximum volume.</p> <p><b>On:</b> Sets your preferred maximum volume.</p> <p><b>Notes:</b></p> <ul style="list-style-type: none"> <li>• If the "Maximum VOL level" is set lower than the "Initial VOL level", the "Initial VOL level" automatically becomes the same as the "Maximum VOL level".</li> <li>• The volume display can go up to 63 regardless of the settings.</li> <li>• You can hear the changed volume regardless of your volume setting before opening the options menu if you adjust the volume when "Maximum VOL level" is "On" and cursor is on the menu.</li> </ul>

Item	Adjustments
<b>Input lock</b>	<p>Locks the input switch operation.  <b>Off</b> ↔ <b>HDMI1</b> ↔ <b>HDMI2</b> ↔ <b>SLOT INPUT*1</b> ↔ <b>VIDEO</b> ↔ <b>COMPONENT*2</b> ↔ <b>PC</b> ↔ <b>DVI</b> ↔ <b>DIGITAL LINK</b> ↔ <b>Miracast(TM)</b> ↔ <b>Panasonic APPLICATION</b> ↔ <b>MEMORY VIEWER</b>                      *1 "SLOT INPUT" is displayed when an optional Terminal Board is installed.                      When a Terminal Board with dual input terminals is installed, "SLOT INPUT A" and "SLOT INPUT B" are displayed.                      *2 "COMPONENT" may be displayed as "RGB" depending on the setting of "Component/RGB-in select". (see page 54)  <b>Notes:</b></p> <ul style="list-style-type: none"> <li>• Only the adjusted signal is displayed (see page 21).</li> <li>• Input switch can be used when this is set to "Off". Two screen display cannot be selected.</li> <li>• In two screen display mode, if anything other than "Off" is set, the value will be fixed as the value input in the single screen display mode.</li> </ul>
<b>Button lock</b>	<p><b>Off</b> ↔ <b>MENU&amp;ENTER</b> ↔ <b>On</b>  <b>Off:</b> All the buttons on main unit can be used.  <b>MENU&amp;ENTER:</b> Locks  MENU and  ENTER/ buttons on main unit.  <b>On:</b> Locks all the button on main unit except the Power switch.                      Sets Button lock with the unit buttons in the following procedure.  <b>Off:</b> Press  + / ▲ four times → Press  INPUT four times → Press  - / ▼ four times → Press  ENTER/ buttons  <b>MENU&amp;ENTER:</b> Press  ENTER/ four times → Press  + / ▲ four times → Press  INPUT four times → Press  ENTER/ buttons  <b>On:</b> Press  - / ▼ four times → Press  ENTER/ four times → Press  + / ▲ four times → Press  ENTER/ buttons</p>
<b>Remocon User level</b>	<p><b>Off</b> ↔ <b>User1</b> ↔ <b>User2</b> ↔ <b>User3</b>  <b>Off:</b> You can use all of the buttons on the remote control.  <b>User1:</b> You can only use , , , , ,  buttons on the remote control.  <b>User2:</b> You can only use  button on the remote control.  <b>User3:</b> Locks all the buttons on remote control.</p>
<b>Off-timer function</b>	<p><b>Enable:</b> Enables the "Off-timer function".  <b>Disable:</b> Disables the "Off-timer function".  <b>Note:</b> When "Disable" is set, the Off-timer is cancelled.</p>
<b>Initial Power Mode</b>	<p><b>Normal</b> ↔ <b>Standby</b> ↔ <b>On</b>                      Sets the power mode of the unit for when the power recovers from failure or after plugging off and in again.  <b>Normal:</b> Power returns in as the same state as before the power interruption.  <b>Standby:</b> Power returns in standby mode. (Power Indicator : red/orange)  <b>On:</b> Power returns in power On. (Power Indicator : green)  <b>Note:</b> When using multiple displays, "Standby" is preferred to be set in order to reduce a power load.</p>
<b>ID select</b>	<p>Sets panel ID number when panel is used in "Serial ID".                      Set value range: 0 - 100                      (Standard value: 0)</p>
<b>Serial ID</b>	<p>Sets the panel ID Control.  <b>Off:</b> Disables external control by the ID.  <b>On:</b> Enables the external control by the ID.</p>
<b>Display size</b>	<p>Adjusts the image display size on screen.  <b>Off:</b> Sets the normal image display size on screen.  <b>On:</b> Sets the image display size approximately 95 % of the normal image display.</p> <div style="display: flex; justify-content: space-around; align-items: center;"> <div style="text-align: center;"> <p><b>Off</b></p>  </div> <div style="text-align: center;"> <p><b>On</b></p>  </div> </div> <p><b>Notes:</b></p> <ul style="list-style-type: none"> <li>• This setting is valid only when the input signals are as follows;                      NTSC, PAL, SECAM, M.NTSC, PAL60, PAL-M, PAL-N (Video)                      525i, 525p, 625i, 625p, 750/60p, 750/50p, 1125/60i, 1125/50i, 1125/24psF, 1125/25p, 1125/24p, 1125/30p, 1125/60p, 1125/50p, 1250/50i (Component Video, RGB, DVI, SDI, HDMI)</li> <li>• This setting is invalid when digital zoom is selected.</li> <li>• When "Display size" is set to "On", "H-Pos" and "V-Pos" in "Pos./Size" can be adjusted.</li> <li>• Refer to each board's operating instruction for DVI, SDI, HDMI's corresponding signals.</li> </ul>

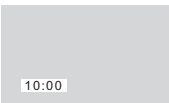
# Options Adjustments

Item	Adjustments
Studio W/B	<b>Off:</b> Nullify all the settings adjusted. <b>On:</b> Sets the colour temperature for TV studio. <b>Note:</b> Valid only when the "Warm" is set as "White balance" in Picture menu.
Studio Gain	Sharpens the contrast for a better view when a part of the image is too light to see. <b>Off:</b> Disables "Studio Gain". <b>On:</b> Enables "Studio Gain". <b>Note:</b> This setting is valid only when the input signals are as follows: Component Video, RGB (analog), SDI, HDMI
LAN Control Protocol	Select the LAN control protocol. <b>Protocol 1:</b> Control with the Panasonic Display sequence. <b>Protocol 2:</b> Control with the sequence that compatible with Panasonic Projector.
RS-232C/LAN Information Timing	Set up the informing manner if error warning occurred. (see page 65)
Slot power	<b>Off</b> $\leftrightarrow$ <b>Auto</b> $\leftrightarrow$ <b>On</b> <b>Off:</b> Power is not transmitted to the slot power. <b>Auto:</b> Power is transmitted to the slot power only when main power is on. <b>On:</b> Power is transmitted to the slot power when main power is on or in the standby state. <b>Note:</b> In some cases, power is transmitted to the slot power when main power is on or in the standby state regardless of the slot power setting.
Power On Screen Delay	<b>Off</b> $\leftrightarrow$ <b>1</b> $\leftrightarrow$ <b>2</b> $\leftrightarrow$ <b>3</b> ... $\leftrightarrow$ <b>30</b> You can set the power-on delay time of the displays to reduce the power load, when you press $\odot$ /  to turn on the multiple displays that are set together. Set each display's setting individually. <b>Off:</b> The display will be turned on at the same time as $\odot$ /  is pressed. <b>1 to 30 (sec.):</b> Set the power-on delay time (second). After pressing $\odot$ / , the display will be powered on with time delay depending on this setting. <b>Notes:</b> <ul style="list-style-type: none"> <li>• During this function is working, the power indicator is blinking green.</li> <li>• This function also works when the power recovers from failure or after plugging off and in again the power cord.</li> </ul> After you unplug and plug the power cord in while the unit is in standby mode and also the power is being supplied to a terminal board, the unit will start supplying the power to the board with time delay according to the setting. The power indicator lights up red first and it turns orange when the power starts being supplied to the board.
DVI Power management mode	Sets the operational mode of "DVI-D Power management". <b>Standard mode:</b> Activates power management when synchronization signals are not detected. <b>Low power mode:</b> Activates power management also when +5V DC in DVI-D IN terminal is not detected.
Clock Display	<b>Off:</b> Not display the clock. <b>On:</b> Display the clock. The clock is displayed at the lower left of the screen when  button is pressed.  <b>Note:</b> When "Day/Time Settings" is not set, the clock is not displayed even if "Clock Display" is "On". (see page 45)
All Aspect	Sets All Aspect mode (advanced aspect setting) or default aspect mode. With each press of  button, the aspect changes in the selected mode. <b>Off:</b> Default aspect mode <b>On:</b> All Aspect mode Aspect mode of each setting is as follows: (Example: HD signal) <b>Off</b> [TH-50LFC70U, TH-65LFC70U, TH-80LFC70U] 4:3 $\rightarrow$ H-FILL $\rightarrow$ ZOOM $\rightarrow$ FULL $\rightarrow$ JUST [TH-50LFC70E, TH-65LFC70E, TH-80LFC70E, TH-50LFC70W, TH-65LFC70W, TH-80LFC70W] 4:3 $\rightarrow$ 4:3 Full $\rightarrow$ Zoom1 $\rightarrow$ Zoom2 $\rightarrow$ Zoom3 $\rightarrow$ 16:9 $\rightarrow$ 14:9 $\rightarrow$ Just <b>On</b> 4:3 (1) $\rightarrow$ 4:3 (2) $\rightarrow$ 4:3 Full $\rightarrow$ Zoom1 $\rightarrow$ Zoom2 $\rightarrow$ Zoom3 $\rightarrow$ 16:9 $\rightarrow$ 14:9 $\rightarrow$ Just1 $\rightarrow$ Just2
Auto Setup	Sets the operational mode of the automatic position adjustment in the Pos./Size menu. <b>Manual:</b> Automatic position adjustment starts when  is pressed on the remote control or automatic position adjustment is executed from the Pos./Size menu. <b>Auto:</b> Other than remote control or menu operation, automatic position adjustment starts: When the display power is turned ON. When the input signal is switched.

Item	Adjustments
<b>Power On Message (No activity power off)</b>	Whether to show/hide No activity power off Precautions at the time of power ON is set. <b>On:</b> The warning precautions are shown at the time of power ON. <b>Off:</b> The warning precautions are not shown at the time of power ON. <b>Note:</b> This setting is enabled only if “No activity power off” is “Enable” (see page 53).
<b>Power On Message (Power Management)</b>	Whether to show/hide an information message that tells the power has been turned off by Power Management when the power is set to ON. <b>On:</b> The information is shown at the time of power ON. <b>Off:</b> The information is not shown at the time of power ON. <b>Note:</b> This setting is enabled only if “Power management” function is “On” (see page 49).

## Normalisation

When both main unit buttons and remote control are disabled due to the “Button lock” or “Remocon User level” adjustments, set all the values “Off” so that all the buttons are enabled again.



Press the button on main unit together with button on the remote control and hold for more than 5 seconds. The “Shipping” menu is displayed and the lock is released when it disappears.

# Weekly Command Timer

You can set 7-day timer programming by setting time and command.

## Note:

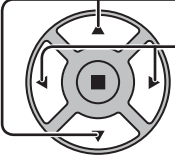

Before setting Weekly Command Timer, set Day/Time Settings. (see page 45)

**1**  Press to select Function.  
 Press to select “On”.

**Note:**

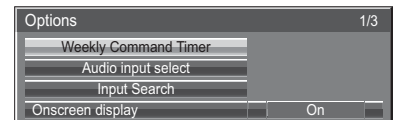
- When Function is set to On, On/Off Timer Settings (see page 45) is unavailable and Interval / Time Designation in Mode of Screensaver (see page 47) cannot be selected.

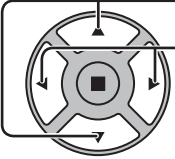

**2**  Press to select a day.  
 Press to select a program number.

**Note:**

- You can set the program from 1 to 7. --- indicates unset.

↓ Press ACTION (■) button

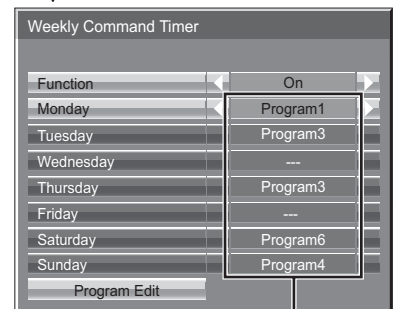

Program number

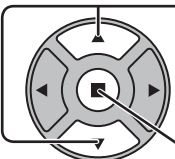
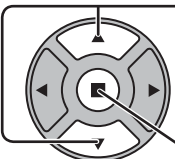
**3**  Press to select Program Edit.  
 Press to show the Program Edit screen.

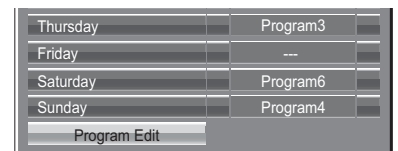

Program Edit screen

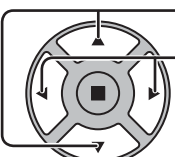
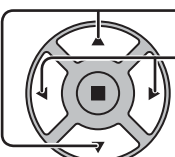
**4**  Press to select Program.  
 Press to change the program numbers (1-7).

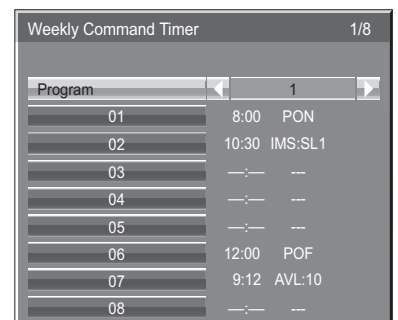

# Options Adjustments

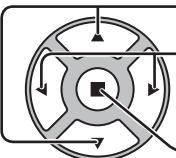
- 5**
- 
- Press to select a command number.
  - Press to show the previous / next command pages (1-8) of the selected program.
  - Press to show the command setting screen.

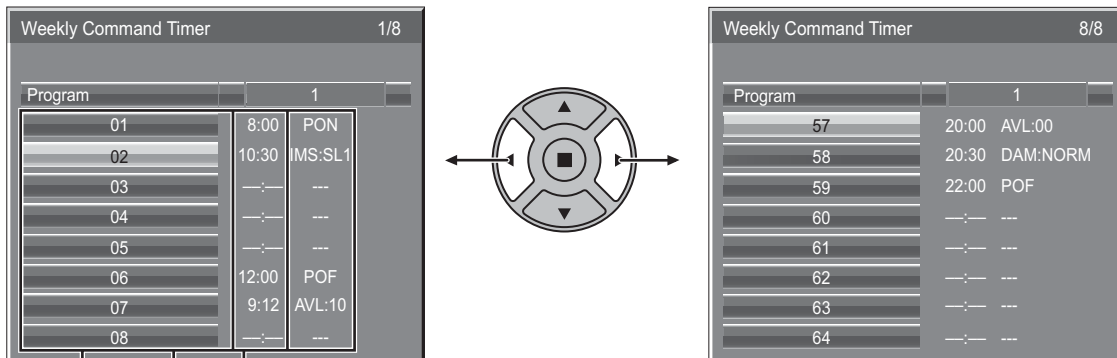

Command numbers	Set time of timer	Command
---	---	---
01	8:00	PON
02	10:30	IMS:SL1
03	---	---
04	---	---
05	---	---
06	12:00	POF
07	9:12	AVL:10
08	---	---

Command (--- indicates unset)  
Set time of timer(---:-- indicates unset)

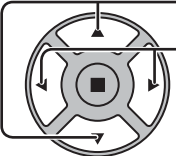
- 6**
- 
- Press to select Command No.
  - Press to select a command number.

Command setting screen

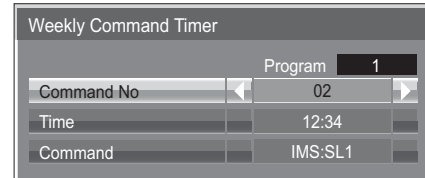

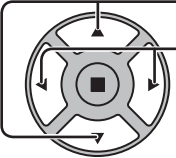
- 7**
- 
- Press to select Time / Command.
  - Press to set each item.
- Time: Set the time to execute a command program.  
Pressing “◀” or “▶” button once changes “Time” 1 minute.  
Pressing “◀” or “▶” button continuously changes “Time” by 15 minutes.
- Command: Select a command to execute at the set time. This unit has 64 commands to set. (see page 73)

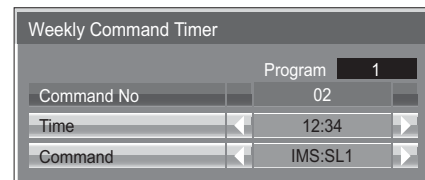

**Notes:**

- Command is performed in order of execution time, regardless of the command number.
- If a command execution time overlaps with that of other commands, these commands are performed in number order.
- Pressing  $\bigcirc^N$ , Time becomes --:-- and Command becomes ---.

**Note:**  
Press  $\bigcirc^R$  to return to the previous screen.



## Audio input select

Set up the sound when an image input is selected.

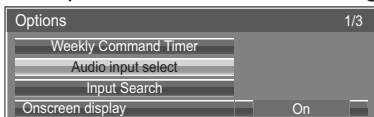

↓ Press ACTION (■) button

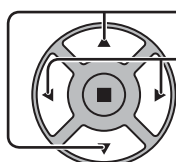
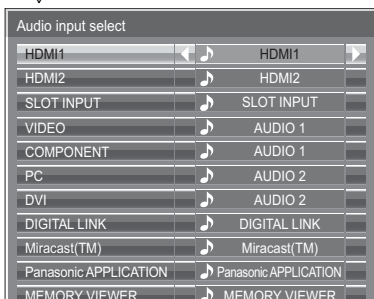

Press to select image input.

Press to select audio input.

Image input	Audio input
[HDMI1]	HDMI1 / SLOT INPUT / AUDIO 1 / AUDIO 2 / NO AUDIO
[HDMI2]	HDMI2 / SLOT INPUT / AUDIO 1 / AUDIO 2 / NO AUDIO
[SLOT INPUT]*1 [VIDEO] [COMPONENT]*2 [PC] [DVI]	SLOT INPUT / AUDIO 1 / AUDIO 2 / NO AUDIO
[DIGITAL LINK]	SLOT INPUT / AUDIO 1 / AUDIO 2 / DIGITAL LINK / NO AUDIO
[Miracast(TM)]	SLOT INPUT / AUDIO 1 / AUDIO 2 / Miracast(TM) / NO AUDIO
[Panasonic APPLICATION]	SLOT INPUT / AUDIO 1 / AUDIO 2 / Panasonic APPLICATION / NO AUDIO
[MEMORY VIEWER]	SLOT INPUT / AUDIO 1 / AUDIO 2 / MEMORY VIEWER / NO AUDIO

NO AUDIO: No audio input (Mute)

\*1 "SLOT INPUT" is displayed when a Terminal Board is installed.

\*2 "COMPONENT" may be displayed as "RGB" depending on the setting of "Component/RGB-in select". (see page 54)

### When a Terminal Board with dual input terminals is installed

"SLOT INPUT" is displayed as "SLOT INPUT A" and "SLOT INPUT B" and independent settings are available. To set other image inputs, you can select "SLOT INPUT A" and "SLOT INPUT B".

Image input	Audio input
[HDMI1]	HDMI1 / SLOT INPUT A / SLOT INPUT B / AUDIO 1 / AUDIO 2 / NO AUDIO
[HDMI2]	HDMI2 / SLOT INPUT A / SLOT INPUT B / AUDIO 1 / AUDIO 2 / NO AUDIO
[SLOT INPUT A]	SLOT INPUT A / AUDIO 1 / AUDIO 2 / NO AUDIO
[SLOT INPUT B]	SLOT INPUT B / AUDIO 1 / AUDIO 2 / NO AUDIO
[VIDEO] [COMPONENT] [PC] [DVI]	SLOT INPUT A / SLOT INPUT B / AUDIO 1 / AUDIO 2 / NO AUDIO
[DIGITAL LINK]	SLOT INPUT A / SLOT INPUT B / AUDIO 1 / AUDIO 2 / DIGITAL LINK / NO AUDIO
[Miracast(TM)]	SLOT INPUT A / SLOT INPUT B / AUDIO 1 / AUDIO 2 / Miracast(TM) / NO AUDIO
[Panasonic APPLICATION]	SLOT INPUT A / SLOT INPUT B / AUDIO 1 / AUDIO 2 / Panasonic APPLICATION / NO AUDIO
[MEMORY VIEWER]	SLOT INPUT A / SLOT INPUT B / AUDIO 1 / AUDIO 2 / MEMORY VIEWER / NO AUDIO

When Image input and Audio input differ from each other, the Audio input is displayed as below.

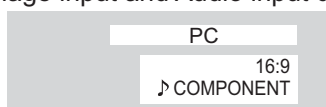

### Notes:

- HDMI Audio is selectable only for HDMI Input.
- You cannot set audio of B for SLOT INPUT A, or audio of A for SLOT INPUT B.

## Input Search

When a signal is not detected, another input with a signal is automatically selected.

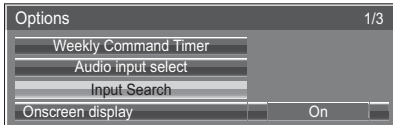

↓ Press ACTION (■) button

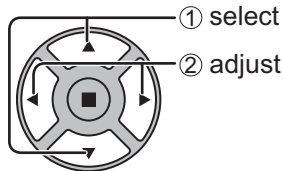
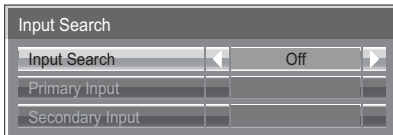

### Input Search

**Off:** When there is no signal, the input is not switched automatically.

**All Inputs:** Searches all inputs and switches to an input with a signal.

Input search is executed in the following order.

(Example) When the current input is PC

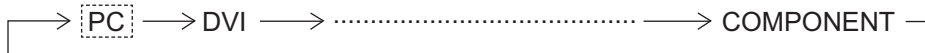

**Priority:** Searches "Primary Input" and "Secondary Input" in order and switches to an input with a signal.

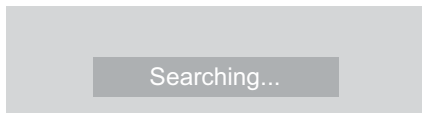

"Searching..." is displayed during the input search.

### Primary Input, Secondary Input

Set the input to search when "Priority" is selected.

**(NONE) ↔ HDMI1 ↔ HDMI2 ↔ SLOT INPUT\* ↔ VIDEO ↔ COMPONENT ↔ PC ↔ DVI ↔ DIGITAL LINK**  
**↔ Panasonic APPLICATION**

\* "SLOT INPUT" is displayed when an optional Terminal Board is installed.

When a Terminal Board with dual input terminals is installed, "SLOT INPUT A" and "SLOT INPUT B" are displayed.

### Notes:

- This menu is available only when "Input lock" is "Off". (see page 59)
- If the input is changed by this function, the last input is selected when the power is turned on next time. If you wish to retain the original input when the power is turned on, set "Initial input" to the original input. (see page 58)

## RS-232C/LAN Information Timing

Set up the informing manner for no signal or temperature rising.

While RS-232C controls: Warning or error message sent on the display automatically.

While LAN controls: Acquire the warning or error message from the display.

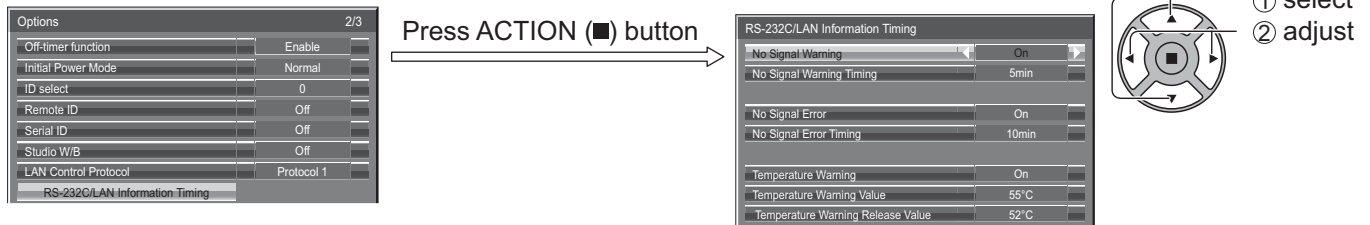

### ■ No Signal Warning

If set to “On”, the display sends out the no signal warning.

### ■ No Signal Warning Timing

Set up the detecting time for no signal warning.

### ■ No Signal Error

If set to “On”, the display sends out the no signal error.

### ■ No Signal Error Timing

Set up the detecting time for no signal error.

The warning of “No Signal Warning” and the error of “No Signal Error” are not sent when the no signal state is detected through any of the following functions:

No Signal power off: Enable, PC Power management, DVI-D Power management, HDMI1 Power management, HDMI2 Power management (see page 49)

### Setting Example

No Signal Warning Timing: 5 minutes

No Signal Error Timing: 10 minutes

PC Power management: On (30 seconds)

If there is no signal when PC IN is input, “PC Power management” is activated first and the Display enters the standby mode.

### Note:

The “No Signal Error Timing” cannot be set shorter than “No Signal Warning Timing”.

### ■ Temperature Warning

If set to “On”, the display sends out the warning temperature.

### ■ Temperature Warning Value











Set up the detecting temperature for temperature warning.

### ■ Temperature Warning Release Value

Set up the temperature to release the temperature warning.

# Troubleshooting

Before you call for service, determine the symptoms and make a few simple checks as shown below.

Symptoms		Checks
Picture	Sound	
 Interference	 Noisy Sound	Electrical Appliances Cars / Motorcycles Fluorescent light
 Normal Picture	 No Sound	Volume (Check whether the mute function has been activated on the remote control.)
 No Picture	 No Sound	Not plugged into AC outlet Not switched on Picture and Brightness/Volume setting (Check by pressing the power switch or stand-by button on the remote control.)
 No Picture	 Normal Sound	If a signal with a non-applicable colour system format, or frequency is input, only the input terminal indication is displayed.
 No Colour	 Normal Sound	Colour controls set at minimum level (see page 38, 39)
No remote control operations can be performed.		Check whether the batteries have discharged completely and, if they have not, whether they were inserted properly. Check whether the remote control sensor is exposed to an outdoor light or a strong fluorescent light. Check whether the remote control designed specifically for use with the unit is being used. (The unit cannot be operated by any other remote control.)
A cracking sound is sometimes heard from the unit.		If there is nothing wrong with the picture or sound, this is the sound of the cabinet undergoing very slight contractions in response to changes in the room temperature. There are no adverse effects on the performance or other aspects.
The top or bottom of the picture on the screen is cut off when I use the zoom function.		Adjust the position of the picture on the screen.
Areas at the top and bottom of the screen where the image is missing appear when I use the zoom function.		When using a video software program (such as a cinema size program) with a screen wider than one in the 16:9 mode, blank areas separate from the images are formed at the top and bottom of the screen.
Parts of the unit become hot.		Even when the temperature of parts of the front, top and rear panels has risen, these temperature rises will not pose any problems in terms of performance or quality.
Power automatically turns off unexpectedly.		Check the settings of "No signal power off", "PC Power management", "DVI-D Power management", "HDMI1 Power management", "HDMI2 Power management" and "No activity power off". Any of them may be set to "On (Enable)". (see page 49, 53)
There is no picture displayed or sound output sometimes.		When HDMI or DVI signals are input to the Display using a selector or distributor, sound or images may not be output in the normal fashion depending on the selector or distributor used. The symptoms may be improved by turning the power off and on again, or by replacing the selector or distributor.
Whirring sounds can be heard from the display unit.		The display unit is fitted with a cooling fan to dissipate heat generated during normal use. The whirring sound is caused by rotation of the fan and is not a malfunction.
The RS-232C is uncontrollable*		Check whether the connection has been made properly. (see page 16) When controlling the RS-232C command on page 16 from the RS-232C terminal in the display, make sure that "Control I/F Select" is "RS-232C", and that "Control I/F Select" is "RS-232C(DIGITAL LINK)", and "DIGITAL LINK mode" is "DIGITAL LINK(RS-232C)" when controlling from the RS-232C terminal of the DIGITAL LINK device.
The LAN is uncontrollable*		Check whether the connection has been made properly. Check whether "Control I/F Select" is "DIGITAL LINK/LAN" when controlling with the WEB browser control or the command control. Check whether "LAN Setup" has been configured properly. When connecting to a device of AMX, Crestron Electronics, Inc., or Extron, set "AMX D.D.", "Crestron Connected™", or "Extron XTP" according to the device to use. See the "Signal quality" information of "DIGITAL LINK status" to check the LAN cable status such as whether the LAN cable is disconnected or the cable is not shielded.

Symptoms	Checks
There is no picture displayed or sound output from the DIGITAL LINK terminal.*	Check whether the connection has been made properly between the video (output) equipment and twisted pair cable transmitter and between the twisted pair cable transmitter and this product. Check that "DIGITAL LINK mode" is not set to "LAN".
Power indicator is blinking in red.	There is possibility of malfunction. Please contact an Authorized Service Center.
This LCD Display uses special image processing. Hence a slight time lag may occur between image and audio, depending on the type of input signal. However, this is not a malfunction.	

\* For the network and DIGITAL LINK setup, please refer to the "Network Operations" of the Operating Instructions.

## LCD Display panel

Symptoms	Check
The screen darkens slightly when bright pictures with minimal movements are shown.	The screen will darken slightly when photos, still images of a computer or other pictures with minimal movements are shown for an extended period. This is done to reduce image retention on the screen and the shortening of the screen's service life: It is normal and not indicative of malfunctioning.
It takes a while for the picture to appear.	The unit digitally processes the various signals in order to reproduce esthetically pleasing images. As such, it sometimes takes a few moments for the picture to appear when the power has been turned on, when the input has been switched.
The edges of the images flicker.	Due to the characteristics of the system used to drive the panel, the edges may appear to flicker in the fast-moving parts of the images: This is normal and not indicative of malfunctioning.
There may be red spots, blue spots, green spots and black spots on the screen.	This is a characteristic of liquid crystal panels and is not a problem. The liquid crystal panel is built with very high precision technology giving you fine picture details. Occasionally, a few non-active pixels may appear on the screen as fixed points of red, blue, green, or black. Please note this does not affect the performance of your LCD.
 <p>Image retention appears</p>	Image retention may occur. If you display a still picture for an extended period, the image might remain on the screen. However, it will disappear after a while. This is not considered as malfunction.

### When using Miracast

---

Please refer to the following items if you have problems with the Miracast connection.

#### **Miracast cannot be connected.**

- Is the “Wireless LAN” menu set to “Off”?
- Is the input source [Miracast(TM)] selected correctly?
- Please check the setting of the Miracast-certified device. For details about the connection method of Miracast, refer to the Operating Instructions of the Miracast-certified device.
- Are there any obstacles between the Miracast-certified device and the Display? In addition, is the Miracast-certified device far from the Display?  
Please remove the obstacles or make the Miracast-certified device close to the Display.
- The column “Paired devices” will remain the connection information such as the Miracast-certified device etc., but you cannot reconnect with the screen, please connect with the devices that can be connected from the list.
- Depending on the model or the status of the Miracast-certified device, the connection may be failed.

#### **Disconnected suddenly or Image cannot be updated.**

- If the Miracast idle screen is not displayed, the sound cannot be output, the connection is failed, please re-boot the Display and then return the operation according to the following method.
  - Please turn off the power and disconnect the power plug from the power outlet.
  - Please turn on the Display and the Miracast-certified device.

#### **The picture of Miracast is distorted.**

- Set the wireless LAN mode to “S-DIRECT” or “M-DIRECT”.
- Since Miracast is connected wirelessly, the picture may be distorted by the radio wave environment. In such cases, please try the following measures.
  - Please make the Miracast-certified device close to the Display.
  - Place away from devices that can emit electromagnetic radiation, such as microwave ovens, game machines.  
Do not use these devices if you are still unable to solve the problem.
  - If multiple wireless devices are connected with the same router, the bandwidth will be insufficient.
- If there is a problem with the content itself, the picture may be distorted, please confirm the content.
- The images of Miracast may be distorted depending on the Miracast-certified device. It may be caused by the processing capability and the wireless transmission performance of the Miracast-certified device, and it is not a malfunction of the Display.

#### **The connection of Miracast will be interrupted if there is no operation after connecting with the Miracast.**



- Depending on the configuration of your Miracast-certified device, the connection may be lost in some time. Please check the saving power setting of the device.
- The problem will be improved by updating the wireless driver and firmware. Please contact with the manufacturer for the technical support about the device.

#### **Others**

- Depending on your Miracast-certified device, the confirmation screen of the reconnection that is the connection name “from UNKNOWN” will be displayed. At this time, please select “CANCEL” to cancel reconnect.
- Depending on your Miracast-certified device, it may be required to remove the profile during connecting. In that case, please remove the device according to the instructions.



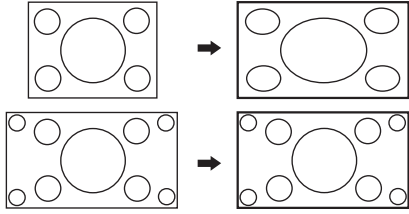
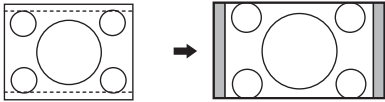
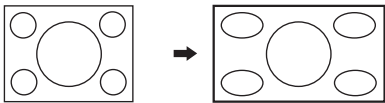
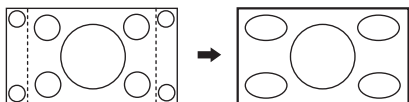
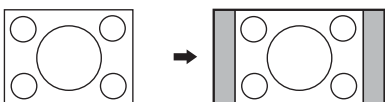
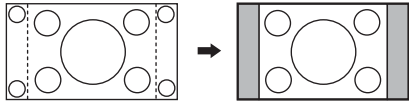
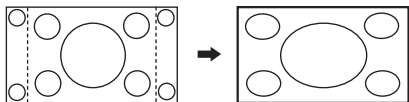
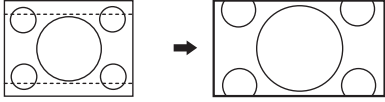
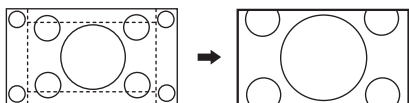

# List of Aspect Modes

[TH-50LFC70U, TH-65LFC70U, TH-80LFC70U]

Aspect mode		Picture → Enlarged screen	Description
All Aspect: On	Factory setting All Aspect: Off		
16:9	FULL		The display of the pictures fills the screen. In the case of SD signals, pictures with a 4:3 aspect ratio are enlarged horizontally, and displayed. This mode is suited to displaying anamorphic pictures with a 16:9 aspect ratio.
14:9	–		Letterbox pictures with a 14:9 aspect ratio are enlarged vertically and horizontally so that their display fills the screen vertically and is slightly smaller than the screen horizontally. The top and bottom edges of the pictures are cut off. Side panels are displayed at the left and right edges of the screen.
Just ----- Just1	JUST		Pictures with a 4:3 aspect ratio are enlarged horizontally so that the picture distortion is minimized. The display of the areas around the left and right edges of the screen is slightly elongated.
Just2	JUST		Pictures with a 4:3 aspect ratio are enlarged horizontally so that the picture distortion is minimized. The left and right edges of the pictures are cut off. The display of the areas around the left and right edges of the screen is slightly elongated.
4:3 ----- 4:3 (1)	4:3		Pictures with a 4:3 aspect ratio are displayed with their original aspect ratio. Side panels are displayed at the left and right edges of the screen.
4:3 (2)	4:3		Pictures with a 4:3 aspect ratio are displayed with their original aspect ratio. The left and right edges of the pictures are masked by side panels.
4:3 Full	H-FILL		Pictures with a 4:3 aspect ratio are enlarged horizontally so that their display fills the screen. The left and right edges of the pictures are cut off.
Zoom ----- Zoom1	ZOOM		Letterbox pictures with a 16:9 aspect ratio are enlarged vertically and horizontally so that their display fills the screen. The top and bottom edges of the pictures are cut off.
Zoom2	ZOOM		Letterbox pictures with a 16:9 aspect ratio are enlarged vertically and horizontally so that their display fills the screen. The top and bottom edges as well as the left and right edges of the pictures are cut off.
Zoom3	–		Letterbox pictures with a 2.35:1 aspect ratio are enlarged vertically and horizontally so that their display fills the screen vertically and is slightly larger than the screen horizontally. The top and bottom edges as well as the left and right edges of the pictures are cut off.

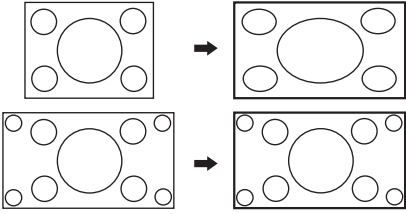
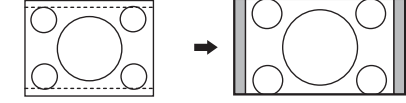
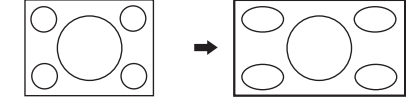
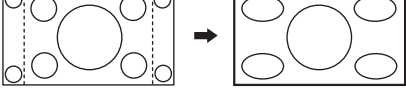
# List of Aspect Modes

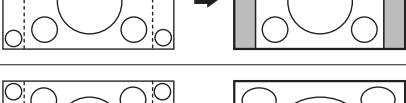
[TH-50LFC70E, TH-65LFC70E, TH-80LFC70E, TH-50LFC70W, TH-65LFC70W, TH-80LFC70W]

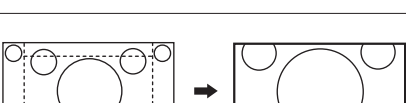
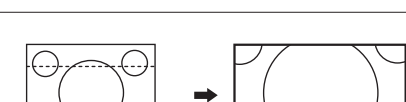
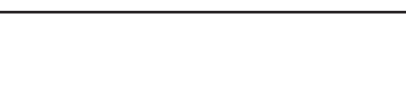
Aspect mode		Picture → Enlarged screen	Description
All Aspect: On	Factory setting All Aspect: Off		
16:9	16:9		The display of the pictures fills the screen. In the case of SD signals, pictures with a 4:3 aspect ratio are enlarged horizontally, and displayed. This mode is suited to displaying anamorphic pictures with a 16:9 aspect ratio.
14:9	14:9		Letterbox pictures with a 14:9 aspect ratio are enlarged vertically and horizontally so that their display fills the screen vertically and is slightly smaller than the screen horizontally. The top and bottom edges of the pictures are cut off. Side panels are displayed at the left and right edges of the screen.
Just ----- Just1	Just		Pictures with a 4:3 aspect ratio are enlarged horizontally so that the picture distortion is minimized. The display of the areas around the left and right edges of the screen is slightly elongated.
Just2	–		The pictures with a 4:3 aspect ratio among the 16:9 aspect ratio signals are enlarged horizontally so that the picture distortion is minimized. The left and right edges of the pictures are cut off. The display of the areas around the left and right edges of the screen is slightly elongated.
4:3 ----- 4:3 (1)	4:3		Pictures with a 4:3 aspect ratio are displayed with their original aspect ratio. Side panels are displayed at the left and right edges of the screen.
4:3 (2)	–		The pictures with a 4:3 aspect ratio among the 16:9 aspect ratio signals are displayed with their original aspect ratio. The left and right edges of the pictures are masked with side panels.
4:3 Full	4:3 Full		The pictures with a 4:3 aspect ratio among the 16:9 aspect ratio signals are enlarged horizontally so that their display fills the screen. The left and right edges of the pictures are cut off.
Zoom ----- Zoom1	Zoom1		Letterbox pictures with a 16:9 aspect ratio are enlarged vertically and horizontally so that their display fills the screen. The top and bottom edges of the pictures are cut off.
Zoom2	Zoom2		The letterbox pictures with a 2.35:1 aspect ratio among the 16:9 aspect ratio signals are enlarged vertically and horizontally so that their display fills the screen. The top and bottom edges as well as the left and right edges of the pictures are cut off.
Zoom3	Zoom3		Letterbox pictures with a 2.35:1 aspect ratio are enlarged vertically and horizontally so that their display fills the screen vertically and is slightly larger than the screen horizontally. The top and bottom edges as well as the left and right edges of the pictures are cut off.



# Applicable Input Signals

\*Mark: Applicable input signal

	Signal name	Horizontal frequency (kHz)	Vertical frequency (Hz)	COMPONENT / RGB IN / PC IN (Dot clock (MHz))	DVI-D IN (Dot clock (MHz))	HDMI1 HDMI2
1	525 (480) / 60i	15.73	59.94	* (13.5)	* (27.0)	*
2	525 (480) / 60p	31.47	59.94	* (27.0) *5	* (27.0)	*
3	625 (575) / 50i	15.63	50.00	* (13.5)		
4	625 (576) / 50i	15.63	50.00		* (27.0)	*
5	625 (575) / 50p	31.25	50.00	* (27.0)		
6	625 (576) / 50p	31.25	50.00		* (27.0)	*
7	750 (720) / 60p	45.00	60.00	* (74.25)	* (74.25)	*
8	750 (720) / 50p	37.50	50.00	* (74.25)	* (74.25)	*
9	1,125 (1,080) / 60p	67.50	60.00	* (148.5) *1	* (148.5)	*
10	1,125 (1,080) / 60i	33.75	60.00	* (74.25) *1	* (74.25)	*
11	1,125 (1,080) / 50p	56.26	50.00	* (148.5) *1	* (148.5)	*
12	1,125 (1,080) / 50i	28.13	50.00	* (74.25) *1	* (74.25)	*
13	1,125 (1,080) / 24psF	27.00	48.00	* (74.25) *2		
14	1,125 (1,080) / 30p	33.75	30.00	* (74.25) *1	* (74.25)	
15	1,125 (1,080) / 25p	28.13	25.00	* (74.25) *1	* (74.25)	
16	1,125 (1,080) / 24p	27.00	24.00	* (74.25) *1	* (74.25)	*
17	1,250 (1,080) / 50i	31.25	50.00	* (74.25) *3		
18	2,048 × 1,080 / 24psF *7	27.00	48.00			
19	2,048 × 1,080 / 24p *7	27.00	24.00			
20	640 × 400 @70 Hz	31.46	70.07	* (25.17)		
21	640 × 480 @60 Hz	31.47	59.94	* (25.18) *6	* (25.18)	*
22	640 × 480 @72 Hz	37.86	72.81	* (31.5)		
23	640 × 480 @75 Hz	37.50	75.00	* (31.5)		
24	640 × 480 @85 Hz	43.27	85.01	* (36.0)		
25	800 × 600 @56 Hz	35.16	56.25	* (36.0)		
26	800 × 600 @60 Hz	37.88	60.32	* (40.0)	* (40.0)	*
27	800 × 600 @72 Hz	48.08	72.19	* (50.0)		
28	800 × 600 @75 Hz	46.88	75.00	* (49.5)		
29	800 × 600 @85 Hz	53.67	85.06	* (56.25)		
30	852 × 480 @60 Hz	31.47	59.94	* (33.54) *6	* (34.24)	*
31	1,024 × 768 @50 Hz	39.55	50.00		* (51.89)	*
32	1,024 × 768 @60 Hz	48.36	60.00	* (65.0)	* (65.0)	*
33	1,024 × 768 @70 Hz	56.48	70.07	* (75.0)		
34	1,024 × 768 @75 Hz	60.02	75.03	* (78.75)		
35	1,024 × 768 @85 Hz	68.68	85.00	* (94.5)		
36	1,066 × 600 @60 Hz	37.64	59.94	* (53.0)	* (53.0)	*
37	1,152 × 864 @60 Hz	53.70	60.00		* (81.62)	*
38	1,152 × 864 @75 Hz	67.50	75.00	* (108.0)		
39	1,280 × 768 @60 Hz	47.70	60.00	* (80.14)		
40	1,280 × 800 @60 Hz (1)	49.31	59.91	* (71.0)	* (71.0)	*
41	1,280 × 800 @60 Hz (2)	49.70	59.81	* (83.5)	* (83.5)	*
42	1,280 × 960 @60 Hz	60.00	60.00	* (108.0)		
43	1,280 × 960 @85 Hz	85.94	85.00	* (148.5)		
44	1,280 × 1,024 @60 Hz	63.98	60.02	* (108.0)	* (108.0)	*
45	1,280 × 1,024 @75 Hz	79.98	75.03	* (135.0)		
46	1,280 × 1,024 @85 Hz	91.15	85.02	* (157.5)		
47	1,366 × 768 @50 Hz	39.55	50.00		* (69.92)	*
48	1,366 × 768 @60 Hz	48.36	60.00	* (86.71)	* (87.44)	*
49	1,400 × 1,050 @60 Hz	65.22	60.00		* (122.61)	*
50	1,440 × 900 @60 Hz (1)	55.47	59.90	* (88.75)	* (88.75)	*
51	1,440 × 900 @60 Hz (2)	55.93	59.89	* (106.5)	* (106.5)	*
52	1,600 × 1,200 @60 Hz	75.00	60.00	* (162.0)	* (162.0)	*
53	1,600 × 1,200 @65 Hz	81.25	65.00	* (175.5)		
54	1,920 × 1,080 @60 Hz	67.50	60.00	* (148.5) *4	* (148.5)	*
55	1,920 × 1,200 @60 Hz	74.04	59.95		* (154.0)	*
56	Macintosh13" (640 × 480)	35.00	66.67	* (30.24)		
57	Macintosh16" (832 × 624)	49.72	74.54	* (57.28)		
58	Macintosh21" (1,152 × 870)	68.68	75.06	* (100.0)		

\*1: Based on SMPTE 274M standard.

\*2: Based on SMPTE RP211 standard.

\*3: Based on SMPTE 295M standard.

\*4: The input signal is recognized as 1,125 (1,080) / 60p.

\*5: When selected the RGB format and 525p signal input to the PC IN terminal, it is recognized as VGA 60Hz signal.

\*6: When inputted VGA 60Hz format signal from the other than PC IN terminal, it is recognized as 525p signal.

\*7: Based on SMPTE 292M and 372M standards. These signals can be received when the Dual Link HD-SDI Terminal Board (TY-FB11DHD) is installed.

**Note:** Signals without above specification may not be displayed properly.



# Applicable Input Signals

## Video input (VIDEO)

	Signal name	Horizontal frequency(kHz)	Vertical frequency(Hz)
1	NTSC	15.73	59.94
2	PAL	15.63	50.00
3	PAL60	15.73	59.94
4	SECAM	15.63	50.00
5	Modified NTSC	15.73	59.94

# Shipping condition

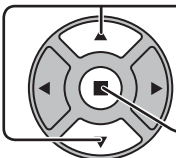
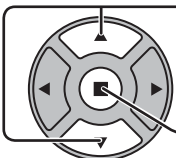
This function allows you to reset the unit to the factory setting.

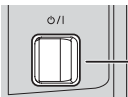
- 1  Press to display the Setup menu.
- 2  Press to select "OSD Language".  
Press for more than 3 seconds.
- 3  Press to select "Shipping".  
Press to display the Shipping menu.
- 4  Press to select "YES".  
Press to confirm.
- 5 Wait for 10 seconds.
- 6  Press the power switch (⏻/⏻) on main unit to turn the power off.

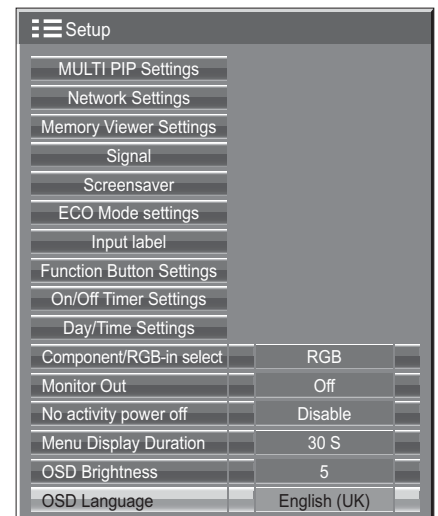

[from the unit]

- 1 Press the MENU button till the Setup menu is displayed.
- 2 Press the Volume Up "+" or Down "-" button to select "OSD Language".
- 3 Press and hold the ENTER button till the Shipping menu is displayed.
- 4 Press the Volume Up "+" or Down "-" button to select "YES".
- 5 Press the ENTER button and wait for 10 sec.
- 6 Press the power switch (⏻/⏻) on main unit to turn the power off.

# Command list of Weekly Command Timer

No.	Command	Control details
1	AAC:MENCLR	Audio Menu (Clear)
2	AAC:MENDYN	Audio Menu (Dynamic)
3	AAC:MENSTD	Audio Menu (Standard)
4	AAC:SURMON	Surround (ON)
5	AAC:SUROFF	Surround (OFF)
6	AMT:0	Audio Mute (OFF)
7	AMT:1	Audio Mute (ON)
8	ASO:M	Audio out when PIP mode (Main Picture)
9	ASO:S	Audio out when PIP mode (Sub Picture)
10	AVL:00	Audio Volume (00)
11	AVL:10	Audio Volume (10)
12	AVL:20	Audio Volume (20)
13	AVL:30	Audio Volume (30)
14	AVL:40	Audio Volume (40)
15	AVL:50	Audio Volume (50)
16	AVL:60	Audio Volume (60)
17	DAM:FULL	Aspect (16:9)
18	DAM:JUST	Aspect (Just)
19	DAM:NORM	Aspect (4:3)
20	-	-
21	DAM:ZOOM	Aspect (Zoom)
22	DWA:OFF	Dual Picture mode (OFF)
23	ISS:SL1	Sub Picture Input Select (SLOT INPUT)
24	ISS:NW1	Sub Picture Input Select (Panasonic APPLICATION)
25	-	-
26	IMS:HM2	Input select (HDMI2) (Main Picture when PIP mode)
27	IMS:DL1	Input select (DIGITAL LINK) (Main Picture when PIP mode)
28	ISS:HM2	Sub Picture Input Select (HDMI2)
29	ISS:DL1	Sub Picture Input Select (DIGITAL LINK)
30	-	-
31	DWA:PIN0	The location of the sub picture (lower right)
32	DWA:PIN1	The location of the sub picture (lower left)
33	DWA:PIN2	The location of the sub picture (upper left)
34	DWA:PIN3	The location of the sub picture (upper right)
35	DWA:PIP	Dual Picture mode (Picture in Picture)
36	-	-
37	DWA:SWP	Swap main picture and sub picture when PIP mode
38	-	-
39	IMS:SL1	Input select (SLOT INPUT) (Main Picture when PIP mode)
40	IMS:S1A	Input select (SLOT INPUT A) (Main Picture when PIP mode)
41	IMS:S1B	Input select (SLOT INPUT B) (Main Picture when PIP mode)
42	IMS:VD1	Input select (VIDEO) (Main Picture when PIP mode)
43	IMS:YP1	Input select (COMPONENT) (Main Picture when PIP mode)
44	IMS:HM1	Input select (HDMI1) (Main Picture when PIP mode)
45	IMS:DV1	Input select (DVI) (Main Picture when PIP mode)
46	IMS:PC1	Input select (PC) (Main Picture when PIP mode)
47	IMS:NW1	Input select (Panasonic APPLICATION) (Main Picture when PIP mode)
48	ISS:S1A	Sub Picture Input Select (SLOT INPUT A)
49	ISS:S1B	Sub Picture Input Select (SLOT INPUT B)
50	ISS:VD1	Sub Picture Input Select (VIDEO)
51	ISS:YP1	Sub Picture Input Select (COMPONENT)
52	ISS:HM1	Sub Picture Input Select (HDMI1)
53	ISS:DV1	Sub Picture Input Select (DVI)
54	ISS:PC1	Sub Picture Input Select (PC)
55	OSP:SCR0	Screen Saver Scrolling bar only (OFF)
56	OSP:SCR1	Screen Saver Scrolling bar only (ON)
57	POF	Power OFF
58	PON	Power ON
59	SSC:FNC0	Screen Saver function (Scrolling bar only)
60	SSC:FNC1	Screen Saver function (Negative image)
61	SSC:MOD0	Screen Saver (Mode (OFF))
62	SSC:MOD3	Screen Saver (Mode (ON))
63	VMT:0*	Picture Mute (OFF)
64	VMT:1*	Picture Mute (ON)

\* Picture Mute cannot be unlocked by powering off/on with the remote control. Turn off and on again with the button on the unit or enter the command VMT:0 to unlock Picture Mute.

# Specifications

	TH-50LFC70U	TH-50LFC70E / TH-50LFC70W
<b>Power Source</b>	110 - 127 V AC, 50/60 Hz	220 - 240 V AC, 50/60 Hz
<b>Power Consumption</b>		
Power on		135 W
Stand-by condition		0.5 W
Power off condition		0.3 W
<b>LCD Display panel</b>	50-inch VA panel (LED backlight), 16:9 aspect ratio	
<b>Screen size</b>	43.1" (W) × 24.2" (H) × 49.5" (diagonal) / 1,095 mm (W) × 616 mm (H) × 1,257 mm (diagonal)	
(No. of pixels)	2,073,600 (1,920 (W) × 1,080 (H)) [5,760 × 1,080 dots]	
<b>Operating condition</b>		
Temperature	32 °F - 104 °F (0 °C - 40 °C)	
Humidity	20 % - 80 % (no condensation)	
<b>Applicable signals</b>		
Colour System	NTSC, PAL, PAL60, SECAM, Modified NTSC	
Scanning format	525 (480) / 60i · 60p, 625 (575) / 50i · 50p, 750 (720) / 60p · 50p, 1125 (1080) / 60i · 60p · 50i · 50p · 24p · 25p · 30p · 24psF, 1250 (1080) / 50i	
PC signals	VGA, SVGA, XGA, SXGA UXGA ··· (compressed) Horizontal scanning frequency 15 - 110 kHz Vertical scanning frequency 48 - 120 Hz	
<b>Connection terminals</b>		
AV IN	VIDEO	BNC 1.0 Vp-p (75 Ω)
	AUDIO 1 IN	Stereo mini jack (M3) × 1 0.5 Vrms, Shared with COMPONENT/RGB IN
	HDMI 1 HDMI 2	TYPE A Connector × 2
COMPONENT/RGB IN	Y/G	BNC with sync 1.0 Vp-p (75 Ω)
	PB/CB/B	BNC 0.7 Vp-p (75 Ω)
	PR/CR/R	BNC 0.7 Vp-p (75 Ω)
	AUDIO 1 IN	Stereo mini jack (M3) × 1 0.5 Vrms, Shared with VIDEO
DVI-D IN		DVI-D 24 Pin Compliance with DVI Revision 1.0
	AUDIO 2 IN	Content Protection Stereo mini jack (M3) × 1 Compatible with HDCP 1.1 0.5 Vrms, Shared with PC IN
PC IN		High-Density Mini D-sub 15 Pin Y or G with sync 1.0 Vp-p (75 Ω) Y or G without sync 0.7 Vp-p (75 Ω) PB/CB/B: 0.7 Vp-p (75 Ω) PR/CR/R: 0.7 Vp-p (75 Ω) HD/VD: 1.0 - 5.0 Vp-p (high impedance)
	AUDIO 2 IN	Stereo mini jack (M3) × 1 0.5 Vrms, Shared with DVI-D IN
SERIAL	External Control Terminal D-sub 9 Pin	RS-232C compatible
PC OUT	R: 0.7 Vp-p (75 Ω) G: 0.7 Vp-p (75 Ω) B: 0.7 Vp-p (75 Ω) HD/VD: 1.0 - 5.0 Vp-p	
USB (VIEWER)	TYPE A USB connector	
DIGITAL LINK / LAN	For RJ45 network and DIGITAL LINK connections, compatible with PLink™ Communication method: RJ45 100BASE-TX	
EXT SP	8 Ω, 20 W [10 W + 10 W] (10 % THD)	
<b>Sound</b>		
Speakers	120 mm × 40 mm × 2 pcs	
Audio Output	20 W [10 W + 10 W] (10 % THD)	
<b>Dimensions (W × H × D)</b>	45.4" × 26.5" × 3.7" / 1,151 mm × 672 mm × 94 mm	
<b>Mass (weight)</b>	approx. 66.2 lbs / 30.0 kg net	

# Specifications

	TH-65LFC70U	TH-65LFC70E / TH-65LFC70W
<b>Power Source</b>	110 - 127 V AC, 50/60 Hz	220 - 240 V AC, 50/60 Hz
<b>Power Consumption</b>		
Power on	210 W	
Stand-by condition	0.5 W	
Power off condition	0.3 W	
<b>LCD Display panel</b>	65-inch VA panel (LED backlight), 16:9 aspect ratio	
<b>Screen size</b>	56.2" (W) × 31.6" (H) × 64.5" (diagonal) / 1,428 mm (W) × 803 mm (H) × 1,638 mm (diagonal)	
(No. of pixels)	2,073,600 (1,920 (W) × 1,080 (H)) [5,760 × 1,080 dots]	
<b>Operating condition</b>		
Temperature	32 °F - 104 °F (0 °C - 40 °C)	
Humidity	20 % - 80 % (no condensation)	
<b>Applicable signals</b>		
Colour System	NTSC, PAL, PAL60, SECAM, Modified NTSC	
Scanning format	525 (480) / 60i · 60p, 625 (575) / 50i · 50p, 750 (720) / 60p · 50p, 1125 (1080) / 60i · 60p · 50i · 50p · 24p · 25p · 30p · 24psF, 1250 (1080) / 50i	
PC signals	VGA, SVGA, XGA, SXGA UXGA ··· (compressed) Horizontal scanning frequency 15 - 110 kHz Vertical scanning frequency 48 - 120 Hz	
<b>Connection terminals</b>		
AV IN	VIDEO AUDIO 1 IN	BNC Stereo mini jack (M3) × 1
	HDMI 1 HDMI 2	TYPE A Connector × 2
	1.0 Vp-p (75 Ω) 0.5 Vrms, Shared with COMPONENT/RGB IN	
COMPONENT/RGB IN		
	Y/G PB/CB/B PR/CR/R AUDIO 1 IN	BNC BNC BNC Stereo mini jack (M3) × 1
	with sync 1.0 Vp-p (75 Ω) 0.7 Vp-p (75 Ω) 0.7 Vp-p (75 Ω) 0.5 Vrms, Shared with VIDEO	
DVI-D IN		DVI-D 24 Pin Content Protection
	AUDIO 2 IN	Stereo mini jack (M3) × 1
	Compliance with DVI Revision 1.0 Compatible with HDCP 1.1 0.5 Vrms, Shared with PC IN	
PC IN		High-Density Mini D-sub 15 Pin
	AUDIO 2 IN	Stereo mini jack (M3) × 1
	Y or G with sync 1.0 Vp-p (75 Ω) Y or G without sync 0.7 Vp-p (75 Ω) PB/CB/B: 0.7 Vp-p (75 Ω) PR/CR/R: 0.7 Vp-p (75 Ω) HD/VD: 1.0 - 5.0 Vp-p (high impedance) 0.5 Vrms, Shared with DVI-D IN	
SERIAL	External Control Terminal D-sub 9 Pin	
	RS-232C compatible	
PC OUT	R: 0.7 Vp-p (75 Ω) G: 0.7 Vp-p (75 Ω) B: 0.7 Vp-p (75 Ω) HD/VD: 1.0 - 5.0 Vp-p	
USB (VIEWER)	TYPE A USB connector	
DIGITAL LINK / LAN	For RJ45 network and DIGITAL LINK connections, compatible with PLink™ Communication method: RJ45 100BASE-TX	
EXT SP	8 Ω, 20 W [10 W + 10 W] (10 % THD)	
<b>Sound</b>		
Speakers	120 mm × 40 mm × 2 pcs	
Audio Output	20 W [10 W + 10 W] (10 % THD)	
<b>Dimensions (W × H × D)</b>	58.5" × 33.8" × 3.9" / 1,484 mm × 859 mm × 97 mm	
<b>Mass (weight)</b>	approx. 121.3 lbs / 55.0 kg net	

# Specifications

	TH-80LFC70U	TH-80LFC70E / TH-80LFC70W
<b>Power Source</b>	110 - 127 V AC, 50/60 Hz	220 - 240 V AC, 50/60 Hz
<b>Power Consumption</b>		
Power on		345 W
Stand-by condition		0.5 W
Power off condition		0.3 W
<b>LCD Display panel</b>	80-inch VA panel (LED backlight), 16:9 aspect ratio	
<b>Screen size</b>	69.7" (W) × 39.2" (H) × 80.0" (diagonal) / 1,771 mm (W) × 996 mm (H) × 2,032 mm (diagonal)	
(No. of pixels)	2,073,600 (1,920 (W) × 1,080 (H)) [5,760 × 1,080 dots]	
<b>Operating condition</b>		
Temperature	32 °F - 104 °F (0 °C - 40 °C)	
Humidity	20 % - 80 % (no condensation)	
<b>Applicable signals</b>		
Colour System	NTSC, PAL, PAL60, SECAM, Modified NTSC	
Scanning format	525 (480) / 60i · 60p, 625 (575) / 50i · 50p, 750 (720) / 60p · 50p, 1125 (1080) / 60i · 60p · 50i · 50p · 24p · 25p · 30p · 24psF, 1250 (1080) / 50i	
PC signals	VGA, SVGA, XGA, SXGA UXGA ··· (compressed) Horizontal scanning frequency 15 - 110 kHz Vertical scanning frequency 48 - 120 Hz	
<b>Connection terminals</b>		
AV IN	VIDEO	BNC
	AUDIO 1 IN	Stereo mini jack (M3) × 1
	HDMI 1	TYPE A Connector × 2
	HDMI 2	
COMPONENT/RGB IN	Y/G	BNC
	PB/CB/B	BNC
	PR/CR/R	BNC
	AUDIO 1 IN	Stereo mini jack (M3) × 1
DVI-D IN		DVI-D 24 Pin
		Content Protection
	AUDIO 2 IN	Stereo mini jack (M3) × 1
PC IN		High-Density Mini D-sub 15 Pin
		Y or G with sync 1.0 Vp-p (75 Ω)
		Y or G without sync 0.7 Vp-p (75 Ω)
		PB/CB/B: 0.7 Vp-p (75 Ω)
		PR/CR/R: 0.7 Vp-p (75 Ω)
		HD/VD: 1.0 - 5.0 Vp-p (high impedance)
	AUDIO 2 IN	Stereo mini jack (M3) × 1
SERIAL		External Control Terminal
		D-sub 9 Pin
		RS-232C compatible
PC OUT		R: 0.7 Vp-p (75 Ω)
		G: 0.7 Vp-p (75 Ω)
		B: 0.7 Vp-p (75 Ω)
		HD/VD: 1.0 - 5.0 Vp-p
USB (VIEWER)		TYPE A USB connector
DIGITAL LINK / LAN		For RJ45 network and DIGITAL LINK connections, compatible with PLink™
		Communication method: RJ45 100BASE-TX
EXT SP		8 Ω, 20 W [10 W + 10 W] (10 % THD)
<b>Sound</b>		
Speakers		120 mm × 40 mm × 2 pcs
Audio Output		20 W [10 W + 10 W] (10 % THD)
<b>Dimensions (W × H × D)</b>	73.6" × 43.1" × 3.9" / 1,868 mm × 1,093 mm × 99 mm	
<b>Mass (weight)</b>	approx. 183.0 lbs / 83.0 kg net	

## Notes:

- Design and specifications are subject to change without notice. Mass and dimensions shown are approximate.
- This equipment complies with the EMC standards listed below.  
EN55022, EN55024, EN61000-3-2, EN61000-3-3.

# Software License

## Software information regarding this product

© Panasonic Corporation 2013

This product incorporates the following software:

- (1) the software which is developed independently by or for Panasonic Corporation
- (2) the software which is licensed under the GNU GENERAL PUBLIC LICENSE
- (3) the software which is licensed under the GNU LESSER GENERAL PUBLIC LICENSE
- (4) the software owned by third party and licensed to Panasonic Corporation
- (5) open source software

For the software categorized as (2) and (3), the license is available in accordance with GNU GENERAL PUBLIC LICENSE and GNU LESSER GENERAL PUBLIC LICENSE respectively. As for the terms and conditions, please refer to the software licence of the supplied CD-ROM. If you wish to ask any questions as to the software, please contact ([oss-cd-request@gg.jp.panasonic.com](mailto:oss-cd-request@gg.jp.panasonic.com)) by email.

The software categorized as (5) is distributed in the hope that it will be useful, but WITHOUT ANY WARRANTY, without even the implied warranty of MERCHANTABILITY or FITNESS FOR A PARTICULAR PURPOSE. Please refer to the detailed terms and conditions thereof shown below.

### **zlib License**

Copyright © 2002-2013 MediaArea.net SARL. All rights reserved.

This software is provided 'as-is', without any express or implied warranty. In no event will the authors be held liable for any damages arising from the use of this software.

Permission is granted to anyone to use this software for any purpose, including commercial applications, and to alter it and redistribute it freely, subject to the following restrictions:

1. The origin of this software must not be misrepresented; you must not claim that you wrote the original software. If you use this software in a product, an acknowledgment in the product documentation would be appreciated but is not required.
2. Altered source versions must be plainly marked as such, and must not be misrepresented as being the original software.
3. This notice may not be removed or altered from any source distribution.

### **MediaInfo(Lib) License**

Copyright © 2002-2013 MediaArea.net SARL. All rights reserved.

Redistribution and use in source and binary forms, with or without modification, are permitted provided that the following conditions are met:

- Redistributions of source code must retain the above copyright notice, this list of conditions and the following disclaimer.
- Redistributions in binary form must reproduce the above copyright notice, this list of conditions and the following disclaimer in the documentation and/or other materials provided with the distribution.

THIS SOFTWARE IS PROVIDED BY THE COPYRIGHT HOLDERS AND CONTRIBUTORS "AS IS" AND ANY EXPRESS OR IMPLIED WARRANTIES, INCLUDING, BUT NOT LIMITED TO, THE IMPLIED WARRANTIES OF MERCHANTABILITY AND FITNESS FOR A PARTICULAR PURPOSE ARE DISCLAIMED. IN NO EVENT SHALL THE COPYRIGHT HOLDER OR CONTRIBUTORS BE LIABLE FOR ANY DIRECT, INDIRECT, INCIDENTAL, SPECIAL, EXEMPLARY, OR CONSEQUENTIAL DAMAGES (INCLUDING, BUT NOT LIMITED TO, PROCUREMENT OF SUBSTITUTE GOODS OR SERVICES; LOSS OF USE, DATA, OR PROFITS; OR BUSINESS INTERRUPTION) HOWEVER CAUSED AND ON ANY THEORY OF LIABILITY, WHETHER IN CONTRACT, STRICT LIABILITY, OR TORT (INCLUDING NEGLIGENCE OR OTHERWISE) ARISING IN ANY WAY OUT OF THE USE OF THIS SOFTWARE, EVEN IF ADVISED OF THE POSSIBILITY OF SUCH DAMAGE.

### **Notice about AVC/VC-1/MPEG-4**

This product is licensed under the AVC Patent Portfolio License, VC-1 Patent Portfolio License and MPEG-4 Visual Patent Portfolio License for the personal use of a consumer or other uses in which it does not receive remuneration to (i) encode video in compliance with the AVC Standard, VC-1 Standard and MPEG-4 Visual Standard ("AVC/VC-1/MPEG-4 Video") and/or (ii) decode AVC/VC-1/MPEG-4 Video that was encoded by a consumer engaged in a personal activity and/or was obtained from a video provider licensed to provide AVC/VC-1/MPEG-4 Video. No license is granted or shall be implied for any other use. Additional information may be obtained from MPEG LA, LLC. See <http://www.mpegla.com>

## Information for Users on Collection and Disposal of Old Equipment and used Batteries



These symbols on the products, packaging, and/or accompanying documents mean that used electrical and electronic products and batteries should not be mixed with general household waste. For proper treatment, recovery and recycling of old products and used batteries, please take them to applicable collection points, in accordance with your national legislation and the Directives 2002/96/EC and 2006/66/EC.

By disposing of these products and batteries correctly, you will help to save valuable resources and prevent any potential negative effects on human health and the environment which could otherwise arise from inappropriate waste handling.

For more information about collection and recycling of old products and batteries, please contact your local municipality, your waste disposal service or the point of sale where you purchased the items. Penalties may be applicable for incorrect disposal of this waste, in accordance with national legislation.

### For business users in the European Union

If you wish to discard electrical and electronic equipment, please contact your dealer or supplier for further information.

### [Information on Disposal in other Countries outside the European Union]

These symbols are only valid in the European Union. If you wish to discard these items, please contact your local authorities or dealer and ask for the correct method of disposal.

### Note for the battery symbol (bottom two symbol examples):

This symbol might be used in combination with a chemical symbol. In this case it complies with the requirement set by the Directive for the chemical involved.

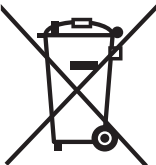

Cd

USA only: Disposal may be regulated in your community due to environmental considerations. For disposal or recycling information, please visit Panasonic website: <http://www.panasonic.com/environmental> or call 1-888-769-0149.

### Customer's Record

The model number and serial number of this product can be found on its rear panel. You should note this serial number in the space provided below and retain this book, plus your purchase receipt, as a permanent record of your purchase to aid in identification in the event of theft or loss, and for Warranty Service purposes.

Model Number \_\_\_\_\_

Serial Number \_\_\_\_\_

### For TH-50LFC70U, TH-65LFC70U and TH-80LFC70U

#### Panasonic System Communications Company of North America

Unit of Panasonic Corporation of North America

#### Executive Office :

Two Riverfront Plaza, Newark, New Jersey 07102-5490

#### Panasonic Canada Inc.

5770 Ambler Drive  
Mississauga, Ontario  
L4W 2T3

---

Panasonic Corporation

Web Site : <http://panasonic.net>

© Panasonic Corporation 2014