

Panasonic®

Model No.

TH-47LFX60U
TH-47LFX6NU
TH-47LFX60W
TH-47LFX6NW

Operating Instructions (Details)

FULL HD LCD Display (for business use)



HDMI

English

Please read these instructions before operating your set and retain them for future reference.

Dear Panasonic Customer

Welcome to the Panasonic family of customers. We hope that you will have many years of enjoyment from your new LCD Display.

To obtain maximum benefit from your set, please read these Instructions before making any adjustments, and retain them for future reference.

Retain your purchase receipt also, and note down the model number and serial number of your set in the space provided on the rear cover of these instructions.

Visit our Panasonic Web Site <http://panasonic.net>

Precautions for Installation

- Do not install by yourself. Please ask a installation professional or your dealer to install.
- This product corresponds to IP55*1 dust and water protection standard. Do not change or damage dust or water resistance of the product.
- Please note the dust and water resistance of this product does not guarantee damage or fault free.



CAUTION

Using with dust or water resistance degraded causes fire, electric shock, or product damage.

This product corresponds to international standard IP rating (Ingress Protection) dust ingress protection level 5 and water ingress protection level 5.

■ Terminal cover

After connecting cable etc. of the device to the terminals, check if the terminal cover is sealed correctly and closed firmly using all the fixing screws when attaching the terminal cover.

To seal the terminal cover correctly, be aware of the following points:

Check if the fixing sealant is fixed in the correct position in the cover. Fixing sealant is an important part to seal the cable part.

Terminal part on main unit rear side

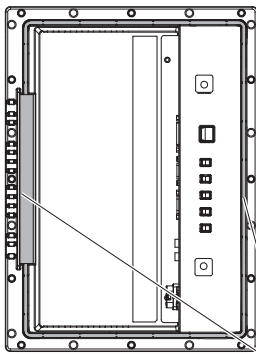

Terminal cover rear side

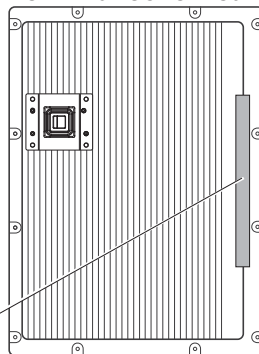

Fixing sealant

Note:

IPX5 water resistance refers to the capability to prevent the harmful effects of water jet from any directions.

Stick the cable to the shape of the dent on the terminal strip base tightly.

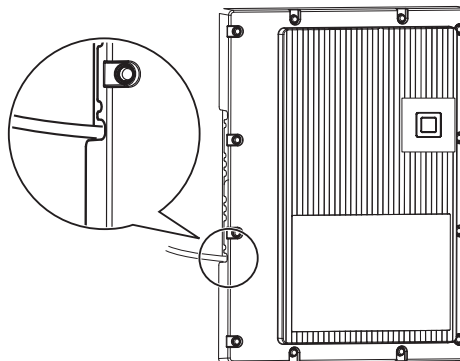
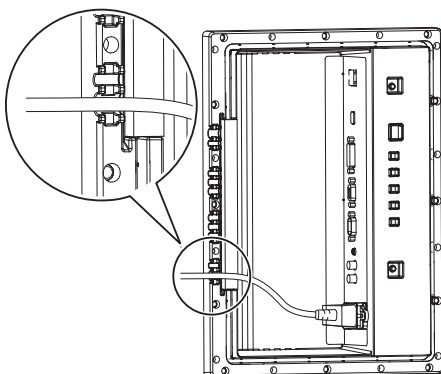

- The structure is to keep the airtightness by tucking the cable pulled out along the dent on the terminal strip base with both fixing sealant of the terminal strip base and terminal cover.

*1: Based on tests performed by Cosmos Corporation.

Precautions for Installation

■ Protective coating

Cabinet aluminum parts and rear face are protected from corrosion with coating. Be careful not to damage the surface. In case the surface is damaged, corrosion may occur from there.

■ Installation position

- When direct sunlight is on the screen, black shadow may appear. This will disappear when the temperature drops.
- To install the product long term in a special environment such as near a swimming pool, hot spring, or ocean, or in a factory uses chemicals or gases, please consult your local Panasonic dealer beforehand.
- The product is equipped with cooling fans and air filters that need to be cleaned or replaced if covered with dust. Removing or installing air filters requires space around the Display. With this in mind, provide adequate space when installing the Display.

[Height 7.874"/200 mm or greater, Width 7.874"/200 mm or greater, Depth 7.874"/200 mm or greater]

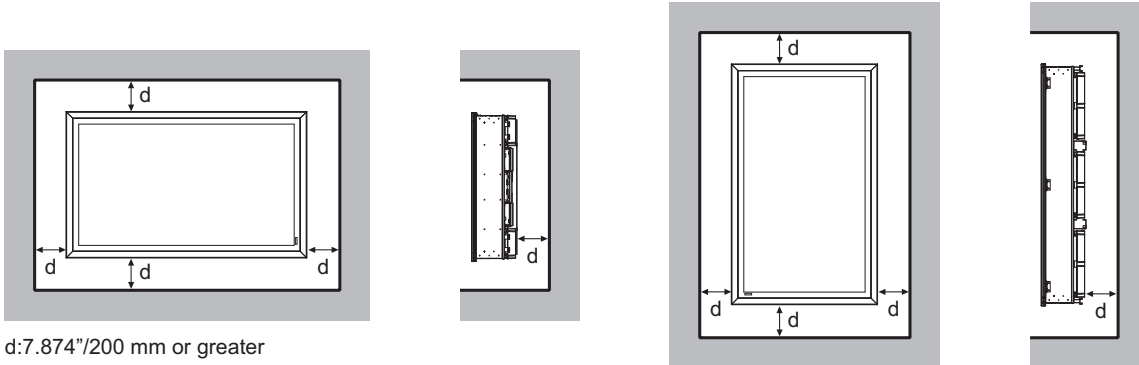

■ Installation conditions

To use the product in an environment where outdoor air temperature is lower than 32 °F (0 °C), make sure to set the "Outdoor mode" to "On". The inside temperature is kept constant and the startup can be performed smoothly. (see page 17, 33)

Consult your dealer if this product will be exhibited or used in a condition where it will be splashed with water continuously or for a long time.

Always use the product at an ambient temperature in the range of 32 °F - 122 °F / 0 °C - 50 °C (during Outdoor mode: -4 °F - 122 °F / -20 °C - 50 °C).

Ambient temperature refers to the temperature of the air immediately in front of the inlets on the back of the Display.

Set Outdoor mode to "On" if the Display is installed where direct sunlight is on the screen.

The Display can be tilted forward or backward at an angle as high as 20 degrees.

■ To install on a wall etc.

- Consult your dealer about fittings etc. beforehand.
- In securing the back side of the Display to a wall, use VESA-based (400 x 400) fittings. Note that any VESA-based fittings should not interfere with the screws (x 10) allowing the filter covers or terminal cover to be attached / removed and the front door to be opened / closed (in the interest of operations by a service contractor).

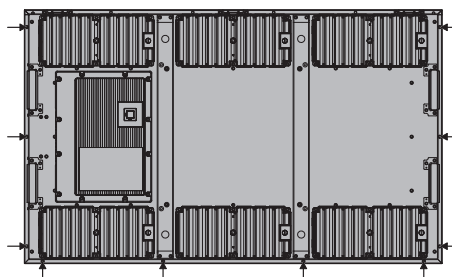

Precautions for Installation

- Choose a permanent position where the total weight of the product and fittings can be hold permanently. If the strength of the position is not sufficient, a serious accident such as fall may be caused.
- Do not install the product where a person can be hang or lean on, or a passer may collide into. Accident may be caused.
- Take measures for tipping over and fall with an assumption of a fitting or installation location failure.
- Installation strength may be degraded due to aging depends on the environment. Ask a installation professional to inspect or repair regularly.
- When an abnormality or fault such as loose screw is detected, ask an installation professional or your dealer immediately for repair.
- Panasonic will not be responsible for any damages from an accident such as defect of installation, improper use, modification, or natural disaster.

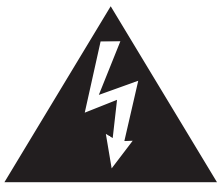

CAUTION

**RISK OF ELECTRIC SHOCK
DO NOT OPEN**



The lightning flash with arrowhead within a triangle is intended to tell the user that parts inside the product are a risk of electric shock to persons.



The exclamation point within a triangle is intended to tell the user that important operating and servicing instructions are in the papers with the appliance.

WARNING: To reduce the risk of electric shock, do not remove cover or back. No user-serviceable parts inside. Refer servicing to qualified service personnel.

- WARNING :**
- 1) To prevent electric shock, do not remove cover. No user serviceable parts inside. Refer servicing to qualified service personnel.
 - 2) Do not remove the grounding pin on the power plug. This apparatus is equipped with a three pin grounding-type power plug. This plug will only fit a grounding-type power outlet. This is a safety feature. If you are unable to insert the plug into the outlet, contact an electrician.

Important Safety Instructions

- 1) Read these instructions.
- 2) Keep these instructions.
- 3) Heed all warnings.
- 4) Follow all instructions.
- 5) Clean only with dry cloth.
- 6) Do not block any ventilation openings. Install in accordance with the manufacturer's instructions.
- 7) Do not install near any heat sources such as radiators, heat registers, stoves, or other apparatus (including amplifiers) that produce heat.
- 8) Do not defeat the safety purpose of the polarized or grounding-type plug. A polarized plug has two blades with one wider than the other. A grounding type plug has two blades and a third grounding prong. The wide blade or the third prong are provided for your safety. If the provided plug does not fit into your outlet, consult an electrician for replacement of the obsolete outlet.
- 9) Protect the power cord from being walked on or pinched particularly at plugs, convenience receptacles, and the point where they exit from the apparatus.
- 10) Only use attachments / accessories specified by the manufacturer.
- 11) Use only with the cart, stand, tripod, bracket, or table specified by the manufacturer, or sold with the apparatus. When a cart is used, use caution when moving the cart / apparatus combination to avoid injury from tip-over.
- 12) Unplug this apparatus during lightning storms or when unused for long periods of time.
- 13) Refer all servicing to qualified service personnel. Servicing is required when the apparatus has been damaged in any way, such as power-supply cord or plug is damaged, liquid has been spilled or objects have fallen into the apparatus, the apparatus has been exposed to rain or moisture, does not operate normally, or has been dropped.
- 14) To prevent electric shock, ensure the grounding pin on the AC cord power plug is securely connected.



FCC STATEMENT

This equipment has been tested and found to comply with the limits for a Class B digital device, pursuant to Part 15 of the FCC Rules. These limits are designed to provide reasonable protection against harmful interference in a residential installation. This equipment generates, uses and can radiate radio frequency energy and, if not installed and used in accordance with the instructions, may cause harmful interference to radio communications. However, there is no guarantee that interference will not occur in a particular installation. If this equipment does cause harmful interference to radio or television reception, which can be determined by turning the equipment off and on, the user is encouraged to try to correct the interference by one or more of the following measures:

- Reorient or relocate the receiving antenna.
- Increase the separation between the equipment and receiver.
- Connect the equipment into an outlet on a circuit different from that to which the receiver is connected.
- Consult the dealer or an experienced technician for help.

This device complies with Part 15 of the FCC Rules. Operation is subject to the following two conditions: (1) This device may not cause harmful interference, and (2) this device must accept any interference received, including interference that may cause undesired operation.

FCC CAUTION:

To assure continued compliance, follow the attached installation instructions and use only shielded interface cables when connecting to computer or peripheral devices. Any changes or modifications not expressly approved by Panasonic Corp. of North America could void the user's authority to operate this device.

FCC Declaration of Conformity

Model No. TH-47LFX60U, TH-47LFX6NU

Responsible Party: Panasonic Corporation of North America
Two Riverfront Plaza, Newark, New Jersey 07102-5490
Contact Source: Panasonic System Communications Company of North America
1-877-655-2357

CANADIAN NOTICE:

This Class B digital apparatus complies with Canadian ICES-003.

Important Safety Notice

WARNING

- 1) **No naked flame sources, such as lighted candles, should be placed on / above the set.**
- 2) To prevent electric shock, do not remove cover. No user serviceable parts inside. Refer servicing to qualified service personnel.
- 3) Do not remove the earthing pin on the power plug. This apparatus is equipped with a three pin earthing-type power plug. This plug will only fit an earthing-type power outlet. This is a safety feature. If you are unable to insert the plug into the outlet, contact an electrician.
Do not defeat the purpose of the earthing plug.
- 4) To prevent electric shock, ensure the earthing pin on the AC cord power plug is securely connected.

CAUTION

This appliance is intended for use in environments which are relatively free of electromagnetic fields. Using this appliance near sources of strong electromagnetic fields or where electrical noise may overlap with the input signals could cause the picture and sound to wobble or cause interference such as noise to appear. To avoid the possibility of harm to this appliance, keep it away from sources of strong electromagnetic fields.

IMPORTANT: THE MOULDED PLUG (For TH-47LFX60W and TH-47LFX6NW)

FOR YOUR SAFETY, PLEASE READ THE FOLLOWING TEXT CAREFULLY.

This display is supplied with a moulded three pin mains plug for your safety and convenience. A 10 amp fuse is fitted in this plug. Shall the fuse need to be replaced, please ensure that the replacement fuse has a rating of 10 amps and that it is approved by ASTA or BSI to BS1362.

Check for the ASTA mark  or the BSI mark  on the body of the fuse.

If the plug contains a removable fuse cover, you must ensure that it is refitted when the fuse is replaced.

If you lose the fuse cover the plug must not be used until a replacement cover is obtained.

A replacement fuse cover can be purchased from your local Panasonic dealer.

Do not cut off the mains plug.

Do not use any other type of mains lead except the one supplied with this display.

The supplied mains lead and moulded plug are designed to be used with this display to avoid interference and for your safety.

If the socket outlet in your home is not suitable, get it changed by a qualified electrician.

If the plug or mains lead becomes damaged, purchase a replacement from an authorized dealer.

WARNING : — THIS DISPLAY MUST BE EARTHED.

How to replace the fuse. Open the fuse compartment with a screwdriver and replace the fuse.

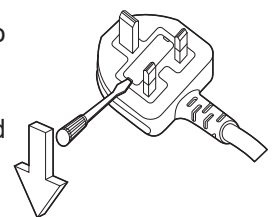

Table of Contents

| | | | |
|--|------|--|----|
| Precautions for Installation | iii | Customizing the Input labels..... | 35 |
| Important Safety Instructions..... | vi | Selecting the On-Screen Menu Language..... | 36 |
| FCC STATEMENT..... | vii | Customizing the On-Screen Menu Display | 36 |
| Important Safety Notice | viii | Setup for MULTI DISPLAY..... | 37 |
| Safety Precautions | 2 | How to Setup MULTI DISPLAY | 37 |
| Accessories | 6 | ID Remote Control Function..... | 38 |
| Accessories Supply | 6 | Setup for Input Signals | 39 |
| Remote Control Batteries | 7 | YUV / RGB-in select..... | 39 |
| About Power Supply Cord..... | 8 | Signal menu | 39 |
| Connections..... | 9 | Cinema reality* | 40 |
| How to remove terminal cover..... | 9 | XGA Mode | 40 |
| AC cord connection | 9 | Sync | 40 |
| Video equipment connection | 10 | HDMI Range..... | 41 |
| AUDIO OUT connection | 11 | Input signal display..... | 41 |
| HDMI connection..... | 11 | Maintenance information..... | 42 |
| DVI-D IN connection..... | 12 | Network Setup | 43 |
| PC Input Terminals connection..... | 13 | Options Adjustments | 46 |
| SERIAL Terminals connection..... | 14 | Input Search | 48 |
| Example connection using the DIGITAL LINK | | RS-232C/LAN Information Timing..... | 49 |
| Terminal..... | 15 | Using Network Function | 50 |
| Power On / Off..... | 16 | Network Connection | 50 |
| Selecting the input signal..... | 18 | DIGITAL LINK Connections (connecting with a | |
| Basic Controls | 19 | twisted pair cable transmitter) | 51 |
| ASPECT Controls | 21 | Command Control | 52 |
| Digital Zoom..... | 22 | PjLink™ Protocol..... | 52 |
| On-Screen Menu Displays | 23 | Using Web Browser Control..... | 53 |
| Adjusting Pos. /Size | 24 | Before Using Web Browser Control..... | 53 |
| Picture Adjustments..... | 26 | Access from Web Browser | 53 |
| Advanced settings | 27 | Display Control (BASIC CONTROL/OPTION | |
| Sound Adjustment..... | 28 | CONTROL Screen) | 54 |
| PRESENT TIME Setup / Set up TIMER..... | 29 | NETWORK SETTING (NETWORK SETTING | |
| PRESENT TIME Setup..... | 29 | Screen)..... | 55 |
| Set up TIMER | 30 | Password Setting (CHANGE PASSWORD | |
| Screensaver (For preventing image retention).... | 31 | Screen)..... | 55 |
| Setup of Screensaver Time | 32 | Crestron Connected™ page..... | 56 |
| Wobbling | 32 | Troubleshooting | 58 |
| No activity power off | 33 | Applicable Input Signals..... | 60 |
| Outdoor mode..... | 33 | Shipping condition..... | 61 |
| ECO Mode settings..... | 34 | Specifications | 62 |

Trademark Credits

- VGA is a trademark of International Business Machines Corporation.
- Microsoft®, Windows®, Windows Vista®, and Internet Explorer® are the registered trademarks or trademarks of Microsoft Corporation in the United States and/or other countries.
- Macintosh, Mac, Mac OS, OS X and Safari are the trademarks of Apple Inc. registered in the United States and other countries.
- SVGA, XGA, SXGA and UXGA are registered trademarks of the Video Electronics Standard Association. Even if no special notation has been made of company or product trademarks, these trademarks have been fully respected.
- HDMI, the HDMI Logo, and High-Definition Multimedia Interface are trademarks or registered trademarks of HDMI Licensing LLC in the United States and other countries.
- RoomView, Crestron RoomView and Fusion RV are registered trademarks of Crestron Electronics, Inc, and Crestron Connected is the trademark of Crestron Electronics, Inc.

Note:

Image retention may occur. If you display a still picture for an extended period, the image might remain on the screen. However, it will disappear after a while.

Safety Precautions

WARNING

■ Setup

This LCD Display is for use only with the following optional accessories. Use with any other type of optional accessories may cause instability which could result in the possibility of injury.

(All of the following accessories are manufactured by Panasonic Corporation.)

Replacement Air Filter TY-AF60STD (Air filter A: 6, Air filter B: 3, Air filter C: 3)

We are not responsible for any product damage, etc. caused by use of the wall-hanging bracket or ceiling-hanging bracket other than those specified, or by failures in the installation environment for the wall-hanging bracket or ceiling-hanging bracket even during the warranty period.

Always be sure to ask a qualified technician to carry out set-up.

Small parts can present choking hazard if accidentally swallowed. Keep small parts away from young children. Discard unneeded small parts and other objects, including packaging materials and plastic bags/sheets to prevent them from being played with by young children, creating the potential risk of suffocation.

Do not place the Display on sloped or unstable surfaces, and ensure that the Display does not hang over the edge of the base.

- The Display may fall off or tip over.

Do not place any objects on top of the Display.

- If any foreign objects get inside the Display, please consult your local Panasonic dealer.

Transport only in upright position!

- Transporting the unit with its display panel facing upright or downward may cause damage to the internal circuitry.

Ventilation should not be impeded by covering the ventilation openings with items such as newspapers, table cloths and curtains.

For sufficient heat release;

Leave a space of 7.874" (20 cm) or more at the top, bottom, right, left, and rear to install.

- Use the product within the operating condition temperature range.
- Do not block any inlet or outlet of the Display.

Cautions for Wall Installation

- Wall installation should be performed by an installation professional. Installing the Display incorrectly may lead to an accident that results in death or serious injury. Furthermore, when installing on a wall, a wall hanging bracket that conforms to VESA standards (VESA 400 × 400) must be used.
- When installing the Display vertically, make sure to place the terminal cover downward.

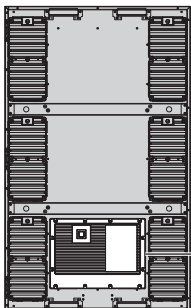

terminal cover

- If you terminate the use of the Display on the wall, ask a professional to remove the Display as soon as possible.

Install the Display away from any heaters.

- This causes cabinet deformation and breakdown.

■ When using the LCD Display

The Display is designed to operate on 110 - 127 or 220 - 240 V AC, 50/60 Hz.

Attach the terminal cover firmly to use.

- Otherwise the dust and water resistance is damaged and may cause fire, electric shock or product damage.

Do not stick any foreign objects into the Display.

- Do not insert any metal or flammable objects into the Display or drop them onto the Display, as doing so can cause fire or electric shock.

Do not remove the cover or modify it in any way.

- High voltages which can cause severe electric shocks are present inside the Display. For any inspection, adjustment and repair work, please contact your local Panasonic dealer.

Ensure that the mains plug is easily accessible.

An apparatus with CLASS I construction shall be connected to a mains socket outlet with a protective earthing connection.

Do not use any power supply cord other than that provided with this unit.

- Doing so may cause fire or electric shocks.

Securely insert the power supply plug as far as it will go.

- If the plug is not fully inserted, heat may be generated which could cause fire. If the plug is damaged or the wall socket is loose, they shall not be used.

Do not handle the power supply plug with wet hands.

- Doing so may cause electric shocks.

Do not do anything that may damage the power cable. When disconnecting the power cable, pull on the plug body, not the cable.

- Do not damage the cable, make any modifications to it, place heavy objects on top of it, heat it, place it near any hot objects, twist it, bend it excessively or pull it. To do so may cause fire and electric shock. If the power cable is damaged, have it repaired at your local Panasonic dealer.

Keep the accessories screw out of reach of children to prevent swallowing.

If the Display is not going to be used for any prolonged length of time, unplug the power supply plug from the wall outlet.

To prevent the spread of fire, keep candles or other open flames away from this product at all times.



■ If problems occur during use

If a problem occurs (such as no picture or no sound), or if smoke or an abnormal odour starts to come out from the Display, immediately unplug the power supply plug from the wall outlet.

- If you continue to use the Display in this condition, fire or electric shock could result. After checking that the smoke has stopped, contact your local Panasonic dealer so that the necessary repairs can be made. Repairing the Display yourself is extremely dangerous, and shall never be done.

If foreign objects get inside the Display, if the Display is dropped, or if the cabinet becomes damages, disconnect the power supply plug immediately.

- A short circuit may occur, which could cause fire. Contact your local Panasonic dealer for any repairs that need to be made.

Safety Precautions

CAUTION

■ When using the LCD Display

Be sure to disconnect all cables before moving the Display.

- If the Display is moved while some of the cables are still connected, the cables may become damaged, and fire or electric shock could result.

Disconnect the power supply plug from the wall socket as a safety precaution before carrying out any cleaning.

- Electric shocks can result if this is not done.

Clean the power cable regularly to prevent it becoming dusty.

- If dust built up on the power cord plug, the resultant humidity can damage the insulation, which could result in fire. Pull the power cord plug out from the wall outlet and wipe the mains lead with a dry cloth.

Do not burn or breakup batteries.

- Batteries must not be exposed to excessive heat such as sunshine, fire or the like.

Power supply

- Install the product near an electrical outlet so that the plug can be unplugged immediately when an abnormality occurs.
- For a wall installation, used a power outlet which can be unplugged immediately when an abnormality occurs.
- This product is energized when the power plug is inserted to a socket. To cut off the power completely, the power plug must be unplugged from the socket.

Cabinet

- Corner part of the metal cabinet is a potential injury hazard.
- To lift the product, hold the handles for the precaution of fall. Injury or damage may be caused.

Do not touch the fans when replacing the air filters.

Cleaning and maintenance

About the glass surface

- If fingerprints or dirt are on the glass surface, clear image cannot be obtained. Please be careful not to scratch or make it dirty.

Dirt on the glass can be cleaned with a sponge, cloth or squeegee. Do not use strong acidic or alkaline solution, especially detergent contains fluoride, otherwise the antireflection material on the glass surface will be affected to have irreparable damage.

The glass has been specially treated. Wipe the glass gently using only a cleaning cloth or a soft, lint-free cloth.

- If the glass is particularly dirty, wipe with a soft, lint-free cloth which has been soaked in pure water or water in which neutral detergent has been diluted 100 times, and then wipe it evenly with a dry cloth of the same type until the surface is dry.

If the cabinet becomes dirty, wipe it with a soft, dry cloth.

- If the cabinet is particularly dirty, soak the cloth in water to which a small amount of neutral detergent has been added and then wring the cloth dry. Use this cloth to wipe the cabinet, and then wipe it dry with a dry cloth.
- Do not allow any detergent to come into direct contact with the surface of the Display. If water droplets get inside the unit, operating problems may result.
- Avoid contact with volatile substances such as insect sprays, solvents and thinner, otherwise the quality of the cabinet surface may be adversely affected or the coating may peel off. Furthermore, do not leave it for long periods in contact with articles made from rubber or PVC.

Maintaining air filters

The cooling structure of the Display is designed to circulate air taken in from outside inside the Display using fans. Air filters are built into the inlet and outlet.

When “Filter” is displayed on the screen as you turn on the power, or when the power indicator is blinking green and orange alternately, there is accumulated dust on the air filters. Check the condition of the air filter and fan in “Maintenance Information” in the Setup menu, and clean or replace the air filter and inspect the fan as necessary. (see page 42)

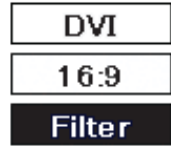

How to remove the air filters

- 1 Unplug the power plug.
- 2 Loosen the decorative screws on the exhaust vent sections until they turn freely.

When replacing the air filters, carefully prevent foreign matter from entering the inside of the Display. If foreign matter has entered, do not try to take it out by force but consult your local Panasonic dealer.

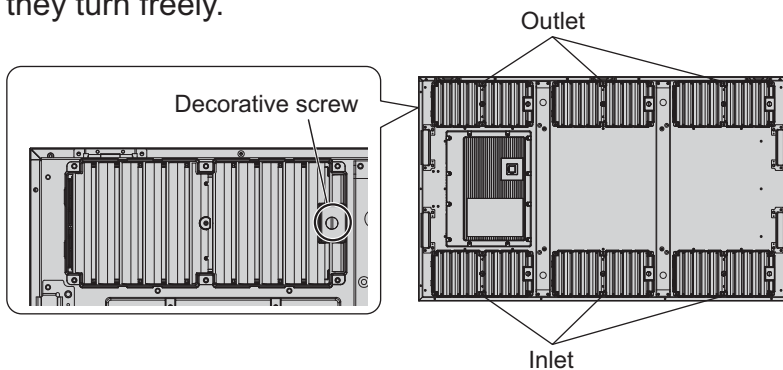

- 3 Remove the filter cover, and pull out the air filter B and air filter C.

- 4 Pull out the air filter A.

How to install the air filters

Install the air filter A.
 Install the air filter B to the outlet.
 Fold the air filter C into thirds and install to the inlet.
 Make sure to install the air filters correctly.
 Attach the filter covers and tighten the decorative screws.
 Check whether the filter covers are secure.

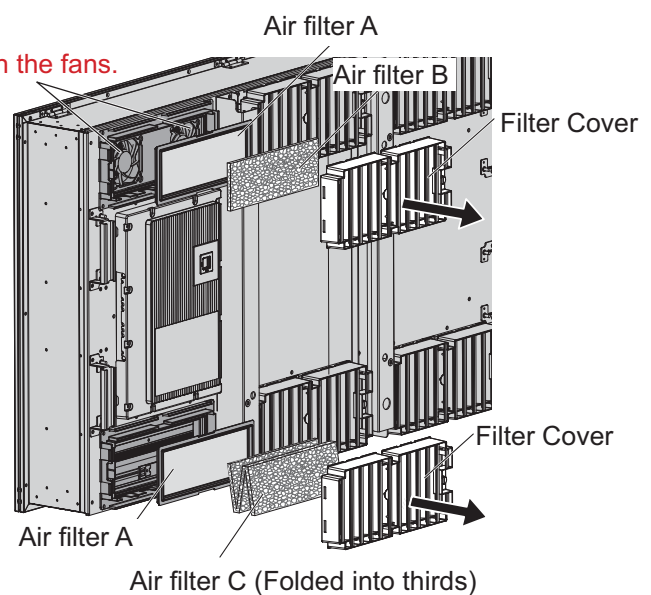

- There is no fan in the inlet.

Cleaning air filters

To clean the air filters, soak in a neutral detergent diluted 200 times with water, rinse well in water, and leave to dry in the shade.

Notes:

- Air filters must be installed before using the Display. The absence of an air filter may cause failure in the Display due to the intake of foreign matter or dust.
- When an air filter is damaged or is unobtrusively soiled even after cleaning, replace the air filter with a new one. Contact your sales agent for replacement.
- The amount of foreign matter or dust adhering to air filters varies depending on the installation location and the used hours. Increase the frequency of cleaning in locations where dust can easily accumulate.
- Do not touch the fans or wiring inside the Display.
- When removing air filters from or installing into the Display set on a high place, take care of your own safety, and avoid the concerned parts falling.
- Clean the air filters approximately once every 1 month and replace them approximately once a year.

Accessories

Accessories Supply

Check that you have the accessories and items shown



Operating Instruction book

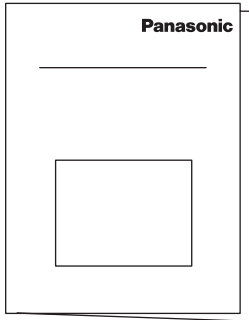

Remote Control Transmitter
N2QAYB000691



Note:

Remote Control Transmitter is not water protection type.



Batteries for the Remote Control Transmitter
(R6 (UM3, AA) Size × 2)

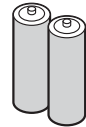

Power supply cord

Main plug types vary between countries. Make sure to use the power supply cord with the voltage and shape appropriate to your country and region. (see page 8)



Door holders × 2

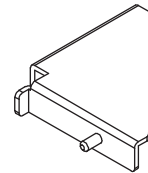

Panasonic badge

An installation professional or service provider will attach it to the Display frame at the time of installation.

Used by a service provider during maintenance work.



Screws × 12
XYN4+F10VM



Attention

Store small parts in an appropriate manner, and keep them away from young children.

Remote Control Batteries

Requires two R6 batteries.

1. Pull and hold the hook, then open the battery cover.
2. Insert batteries - note correct polarity (+ and -).
3. Replace the cover.

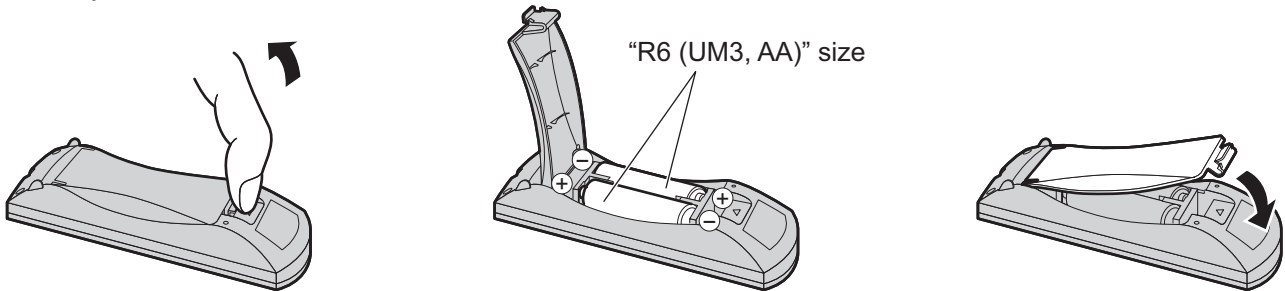
**Helpful Hint:**

For frequent remote control users, replace old batteries with Alkaline batteries for longer life.

⚠ Precaution on battery use

Incorrect installation can cause battery leakage and corrosion that will damage the remote control transmitter. Disposal of batteries should be in an environment-friendly manner.

Observe the following precaution:

1. Batteries shall always be replaced as a pair. Always use new batteries when replacing the old set.
2. Do not combine a used battery with a new one.
3. Do not mix battery types (example: "Zinc Carbon" with "Alkaline").
4. Do not attempt to charge, short-circuit, disassemble, heat or burn used batteries.
5. Battery replacement is necessary when remote control acts sporadically or stops operating the Display set.
6. Do not burn or breakup batteries.
Batteries must not be exposed to excessive heat such as sunshine, fire or the like.

About Power Supply Cord

Main plug types vary between countries. Check the shape of the power plugs to choose the appropriate cable for you.

| Country name and applicable model name | Appropriate AC Cables |
|--|-----------------------------------|
| Asia | |
| India | Cable B or Cable C |
| Indonesia | |
| Philippine | |
| TH-47LFX60W | Cable C |
| TH-47LFX6NW | |
| Malaysia | Cable C |
| Singapore | |
| Hong Kong | |
| Middle East | |
| United Arab Emirates | Cable B or Cable C |
| Iraq | |
| Iran | |
| Oman | |
| TH-47LFX60W | Cable B or Cable C |
| TH-47LFX6NW | |
| Syria | Cable C |
| Lebanon | |
| Qatar | |
| Kuwait | |
| Saudi Arabia | |
| Africa | |
| Egypt | Cable B or Cable C |
| TH-47LFX60W | |
| TH-47LFX6NW | |
| Ethiopia | Cable B or Cable C |
| South Africa | |
| Middle/South America | |
| Uruguay | Cable A |
| Ecuador | |
| Colombia | |
| Chili | |
| TH-47LFX60U | |
| TH-47LFX6NU | |
| Panama | |
| Paraguay | |
| Puerto Rico | |
| Venezuela | |
| Peru | |
| Bolivia | |
| Honduras | |
| North America | |
| USA | Cable A (110-127 V AC Compatible) |
| TH-47LFX60U | |
| TH-47LFX6NU | |
| Canada | |
| Europe | |
| Italy | Cable B |
| Austria | |
| Netherlands | |
| Greece | |
| Switzerland | |
| Sweden | |
| Spain | |
| Czech | |
| Denmark | |
| Germany | |
| Norway | |
| TH-47LFX60W | |
| TH-47LFX6NW | |
| Hungary | |
| Finland | |
| France | |
| Bulgaria | |
| Belgium | |
| Portugal | |
| Poland | |
| Monaco | |
| Luxembourg | |
| Russia | |
| Kazakhstan | |
| Ukraine | |
| Belarus | |
| UK | Cable C |
| Oceania | |
| Australia | Cable D |
| TH-47LFX60W | |
| TH-47LFX6NW | |
| New Zealand | |

TH-47LFX60U, TH-47LFX6NU:

Cable A

Plug Type : A

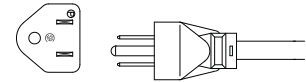

TH-47LFX60W, TH-47LFX6NW:

Cable B

Plug Type : SE

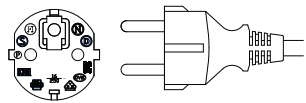

Cable C

Plug Type : BF

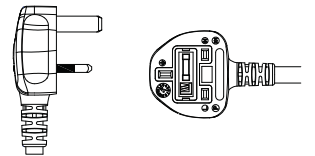

Cable D

Plug Type : O

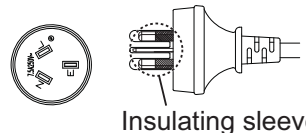

Insulating sleeve

Note:

Depending on the country of destination, relay type or direct attached type of the power supply cord is used.

Connections

How to remove terminal cover

A terminal cover is attached to the input and output terminals to protect them from dust and water. To remove the terminal cover to connect a cable or other item, remove all 12 screws from the terminal cover. Opening the terminal cover with some screws left on will damage the terminal cover.

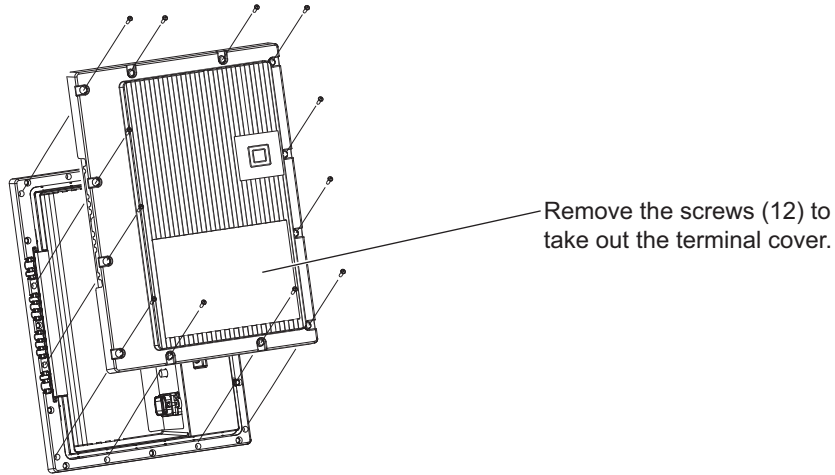

AC cord connection

Notes:

- After connection, check the cable is pulled out along the groove without overlapping, then tighten the all 12 screws to attach the terminal cover correctly. Otherwise water enters inside and causes fire, electric shock and product damage.
- Make sure to read the "Terminal cover" (page iii) section for the correct handling of the terminal cover to use the product properly.

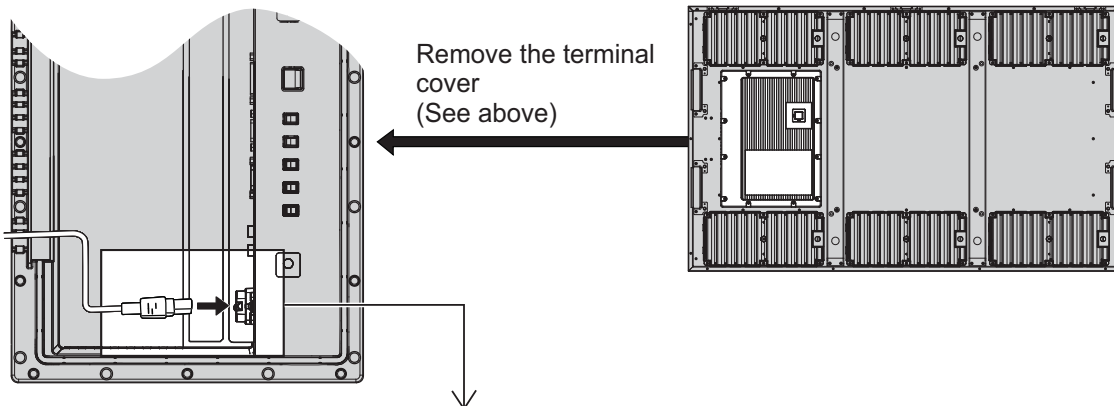

AC cord fixing

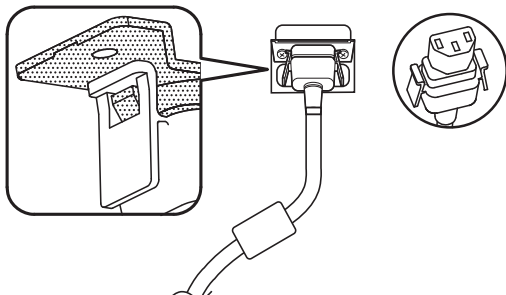

Plug the AC cord into the display unit.

Plug the AC cord until it clicks.

Note:

Make sure that the AC cord is locked on both the left and right sides.

Unplug the AC cord

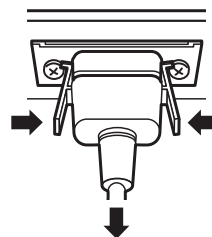

Unplug the AC cord pressing the two knobs.

Note:

When disconnecting the AC cord, be absolutely sure to disconnect the AC cord plug at the socket outlet first.

Video equipment connection

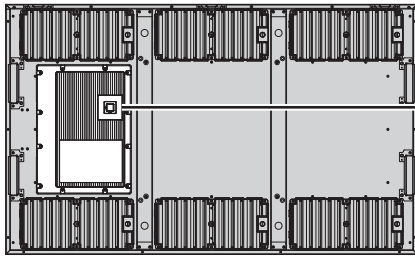

Remove the terminal cover
(see page 9)

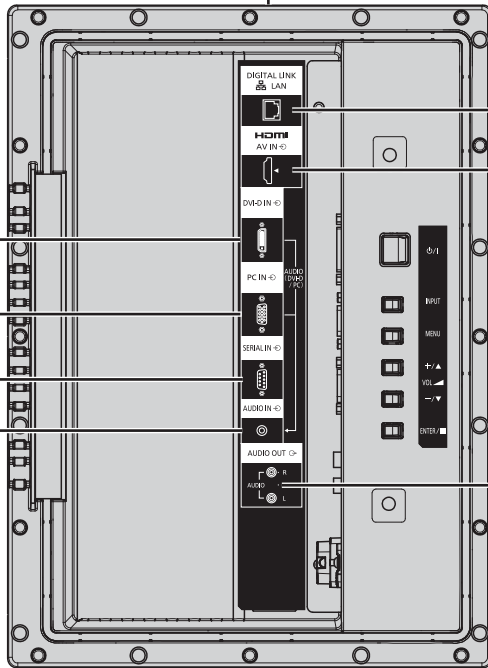

DVI-D IN
DVI-D Input Terminal
(see page 12)

PC IN
PC Input Terminal
(see page 13)

SERIAL
Control the Display by
connecting to PC
(see page 14)

AUDIO (DVI-D / PC)
Connect the audio output of
equipment connected to DVI-D
IN or PC IN.
(see page 12, 13)

LAN, DIGITAL LINK*
Connect to a DIGITAL LINK
input terminal network
to control the Display.
Alternatively, connect to
a device that sends video
and audio signals via the
DIGITAL LINK terminal.
(see page 15)

AV IN
HDMI
HDMI Input Terminal
(see page 11)

AUDIO OUT
Connect to sound
equipment
(see page 11)

Note:

* DIGITAL LINK is technology that enables signals such as audio and video to be transmitted using twisted pair cables. (see page 15, 51)

- Use the screw holes shown in the figures below for such purposes as mounting the brackets for cabling if necessary. (Use the supplied screws for screw holes.)

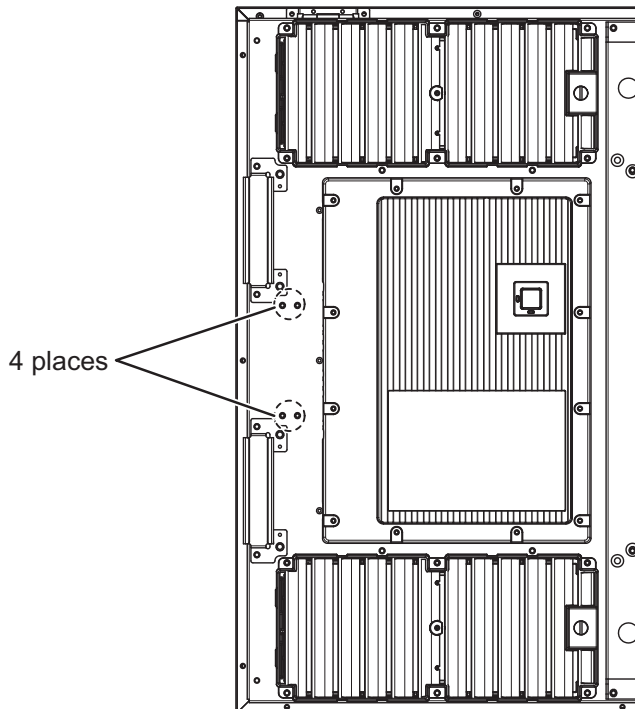
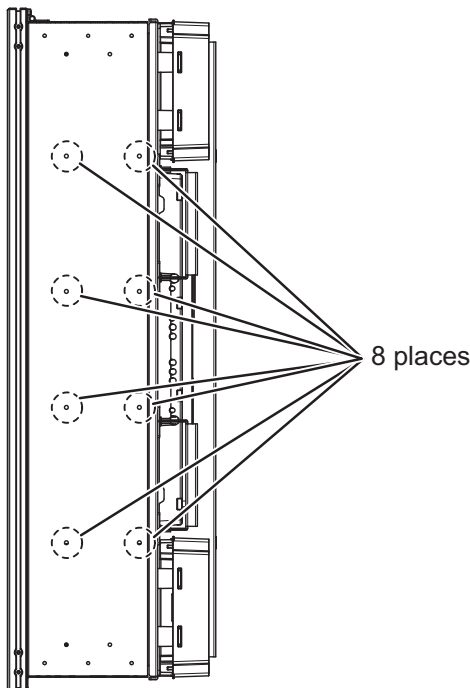

AUDIO OUT connection

Note:

Additional equipment and cables shown are not supplied with this set.

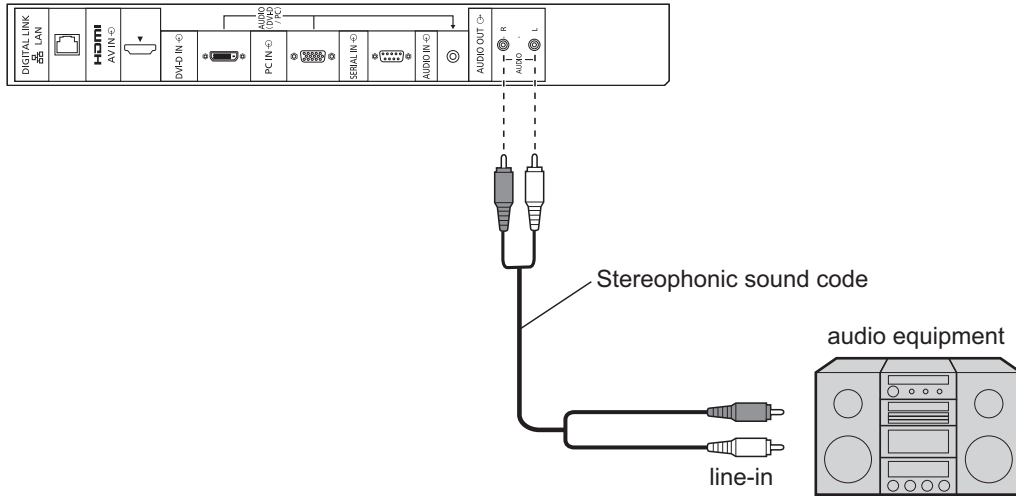

HDMI connection

[Pin assignments and signal names]

| Pin No. | Signal Name | Pin No. | Signal Name |
|---------|----------------------|---------|---------------------------|
| ① | T.M.D.S Data2+ | ⑪ | T.M.D.S Clock Shield |
| ② | T.M.D.S Data2 Shield | ⑫ | T.M.D.S Clock- |
| ③ | T.M.D.S Data2- | ⑬ | CEC |
| ④ | T.M.D.S Data1+ | ⑭ | Reserved (N.C. on device) |
| ⑤ | T.M.D.S Data1 Shield | | |
| ⑥ | T.M.D.S Data1- | ⑮ | SCL |
| ⑦ | T.M.D.S Data0+ | ⑯ | SDA |
| ⑧ | T.M.D.S Data0 Shield | ⑰ | DDC/CEC Ground |
| ⑨ | T.M.D.S Data0- | ⑱ | +5V Power |
| ⑩ | T.M.D.S Clock+ | | Hot Plug Detect |

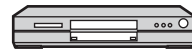

DVD player



HDMI AV OUT



HDMI cables

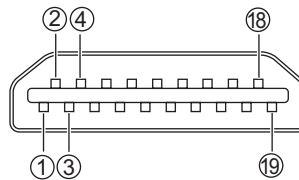
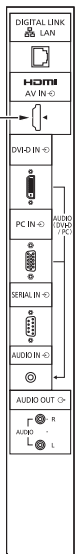

Note:

Additional equipment and HDMI cable shown are not supplied with this set.

DVI-D IN connection

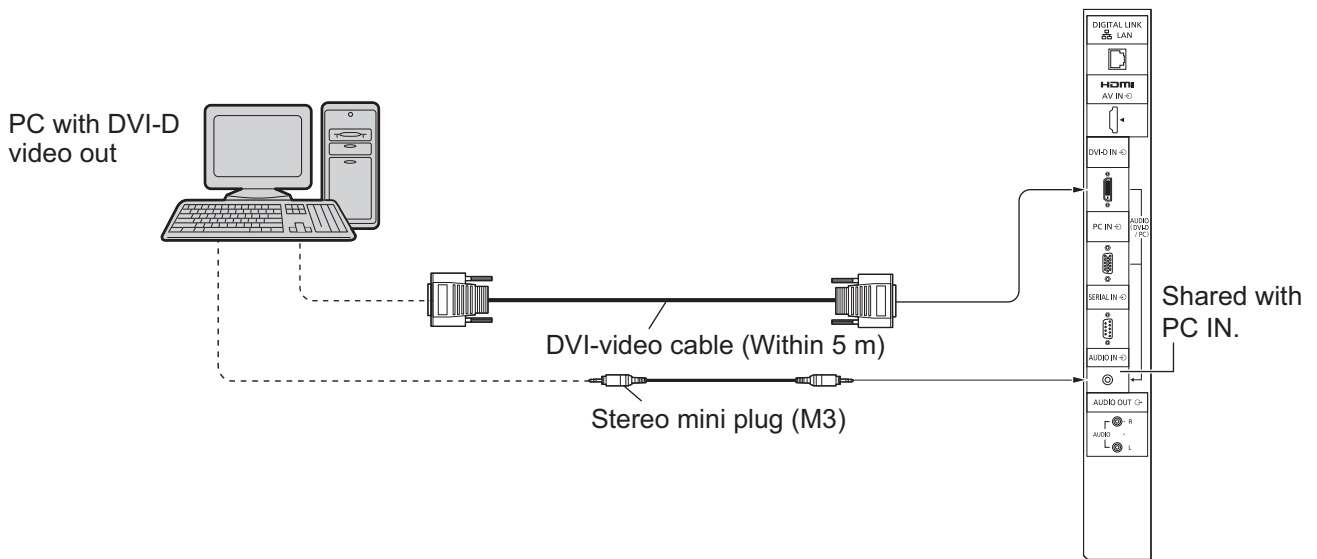

DVI-D Input Connector Pin Layouts

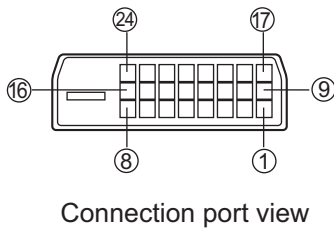

| Pin No. | Signal Name | Pin No. | Signal Name |
|---------|------------------------|---------|------------------------|
| ① | T.M.D.S. data 2- | ⑬ | _____ |
| ② | T.M.D.S. data 2+ | ⑭ | +5 V DC |
| ③ | T.M.D.S. data 2 shield | ⑮ | Ground |
| ④ | _____ | ⑯ | Hot plug detect |
| ⑤ | _____ | ⑰ | T.M.D.S. data 0- |
| ⑥ | DDC clock | ⑱ | T.M.D.S. data 0+ |
| ⑦ | DDC data | ⑲ | T.M.D.S. data 0 shield |
| ⑧ | _____ | ⑳ | _____ |
| ⑨ | T.M.D.S. data 1- | ㉑ | _____ |
| ⑩ | T.M.D.S. data 1+ | ㉒ | T.M.D.S. clock shield |
| ⑪ | T.M.D.S. data 1 shield | ㉓ | T.M.D.S. clock+ |
| ⑫ | _____ | ㉔ | T.M.D.S. clock- |

Note:

Additional equipment and cables shown are not supplied with this set.

PC Input Terminals connection

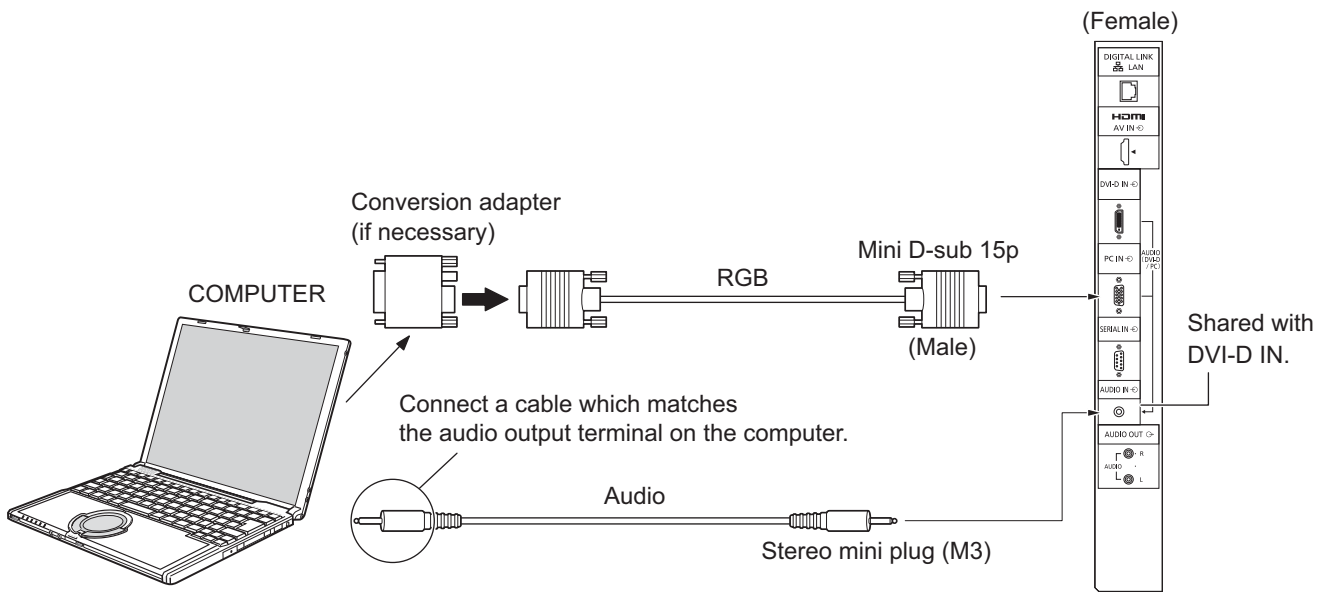

Notes:

- Computer signals which can be input are those with a horizontal scanning frequency of 30 to 110 kHz and vertical scanning frequency of 48 to 120 Hz. (However, the image will not be displayed properly if the signals exceed 1,200 lines.)
- The display resolution is a maximum of 1,440 × 1,080 dots when the aspect mode is set to “4:3”, and 1,920 × 1,080 dots when the aspect mode is set to “16:9”. If the display resolution exceeds these maximums, it may not be possible to show fine detail with sufficient clarity.
- The PC input terminals are DDC2B-compatible. If the computer being connected is not DDC2B-compatible, you will need to make setting changes to the computer at the time of connection.
- Some PC models cannot be connected to the set.
- There is no need to use an adapter for computers with DOS/V compatible Mini D-sub 15P terminal.
- The computer shown in the illustration is for example purposes only.
- Additional equipment and cables shown are not supplied with this set.
- Do not set the horizontal and vertical scanning frequencies for PC signals which are above or below the specified frequency range.

Signal Names for Mini D-sub 15P Connector

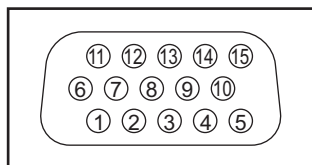

Pin Layout for PC Input Terminal

| Pin No. | Signal Name | Pin No. | Signal Name | Pin No. | Signal Name |
|---------|--------------------|---------|--------------|---------|--------------------|
| ① | R | ⑥ | GND (Ground) | ⑪ | NC (not connected) |
| ② | G | ⑦ | GND (Ground) | ⑫ | SDA |
| ③ | B | ⑧ | GND (Ground) | ⑬ | HD/SYNC |
| ④ | NC (not connected) | ⑨ | +5 V DC | ⑭ | VD |
| ⑤ | GND (Ground) | ⑩ | GND (Ground) | ⑮ | SCL |

SERIAL Terminals connection

The SERIAL terminal is used when the Display is controlled by a computer.

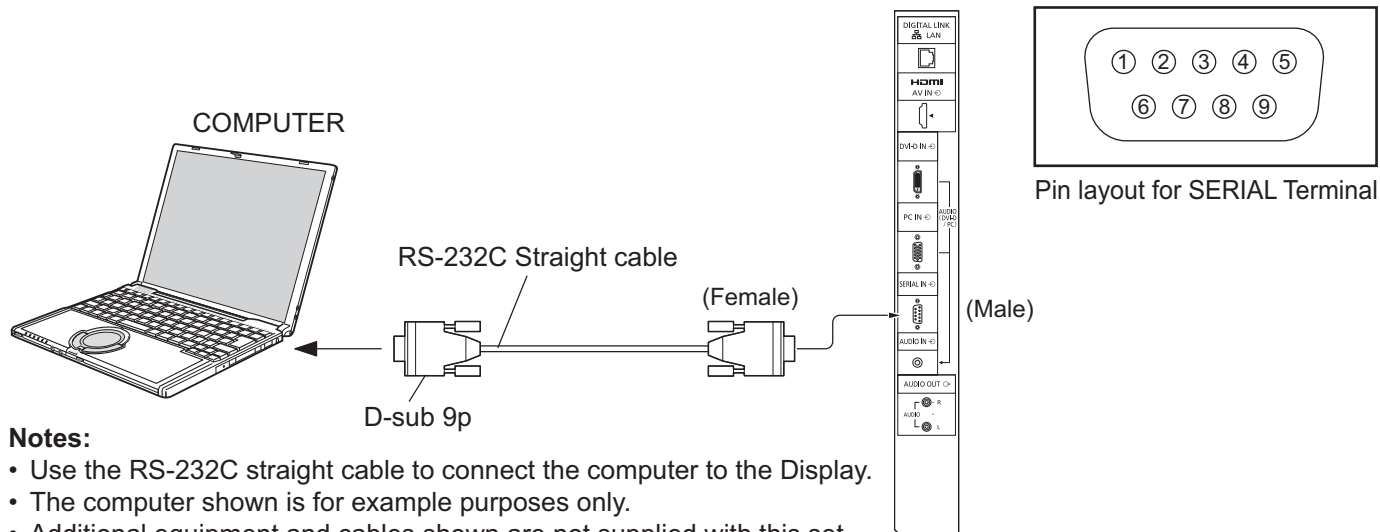

Notes:

- Use the RS-232C straight cable to connect the computer to the Display.
- The computer shown is for example purposes only.
- Additional equipment and cables shown are not supplied with this set.
- When using serial control with this display, be sure to configure the “Control I/F Select” in the “Network Setup” menu. When controlling the Display with RS232C terminal, select “RS-232C (Serial)”. When controlling with the RS232C terminal of a DIGITAL LINK device, select “RS-232C(DIGITAL LINK)”. (see page 43)

The SERIAL terminal conforms to the RS-232C interface specification, so that the Display can be controlled by a computer which is connected to this terminal.

The computer will require software which allows the sending and receiving of control data which satisfies the conditions given below. Use a computer application such as programming language software. Refer to the documentation for the computer application for details.

Communication parameters

| | |
|------------------------|-------------------|
| Signal level | RS-232C compliant |
| Synchronization method | Asynchronous |
| Baud rate | 9600 bps |
| Parity | None |
| Character length | 8 bits |
| Stop bit | 1 bit |
| Flow control | None |

Basic format for control data

The transmission of control data from the computer starts with a STX signal, followed by the command, the parameters, and lastly an ETX signal in that order. If there are no parameters, then the parameter signal does not need to be sent.

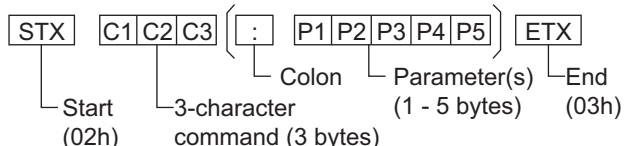

Notes:

- If multiple commands are transmitted, be sure to wait for the response for the first command to come from this unit before sending the next command.
- If an incorrect command is sent by mistake, this unit will send an “ER401” command back to the computer.
- Consult an Authorized Service Center for detail instructions on command usage.

Signal names for D-sub 9P connector

| Pin No. | Details |
|---------|-----------------------|
| ② | R X D |
| ③ | T X D |
| ⑤ | GND |
| ④ • ⑥ | Non use |
| ⑦ ⑧ | (Shorted in this set) |
| ① • ⑨ | NC |

These signal names are those of computer specifications.

Command

| Command | Parameter | Control details |
|---------|-----------|-----------------------------|
| PON | None | Power ON |
| POF | None | Power OFF |
| AVL | *** | Volume 000 - 100 |
| AMT | 0 | Audio MUTE OFF |
| | 1 | Audio MUTE ON |
| IMS | None | Input select (toggle) |
| | HM1 | HDMI input (HDMI) |
| | DV1 | DVI-D IN input (DVI) |
| | PC1 | PC IN input (PC) |
| | DL1 | DIGITAL LINK input |
| DAM | None | Screen mode select (toggle) |
| | ZOOM | Zoom1 |
| | FULL | 16:9 |
| | NORM | 4:3 |
| | ZOM2 | Zoom2 |

With the power off, this display responds to PON command only.

Example connection using the DIGITAL LINK Terminal

A twisted pair cable transmitter such as the **Panasonic Digital Interface Box (ET-YFB100)** uses **twisted pair cables to transmit inputted video and audio signals**, and these digital signals can be input to the Display via the DIGITAL LINK terminal.

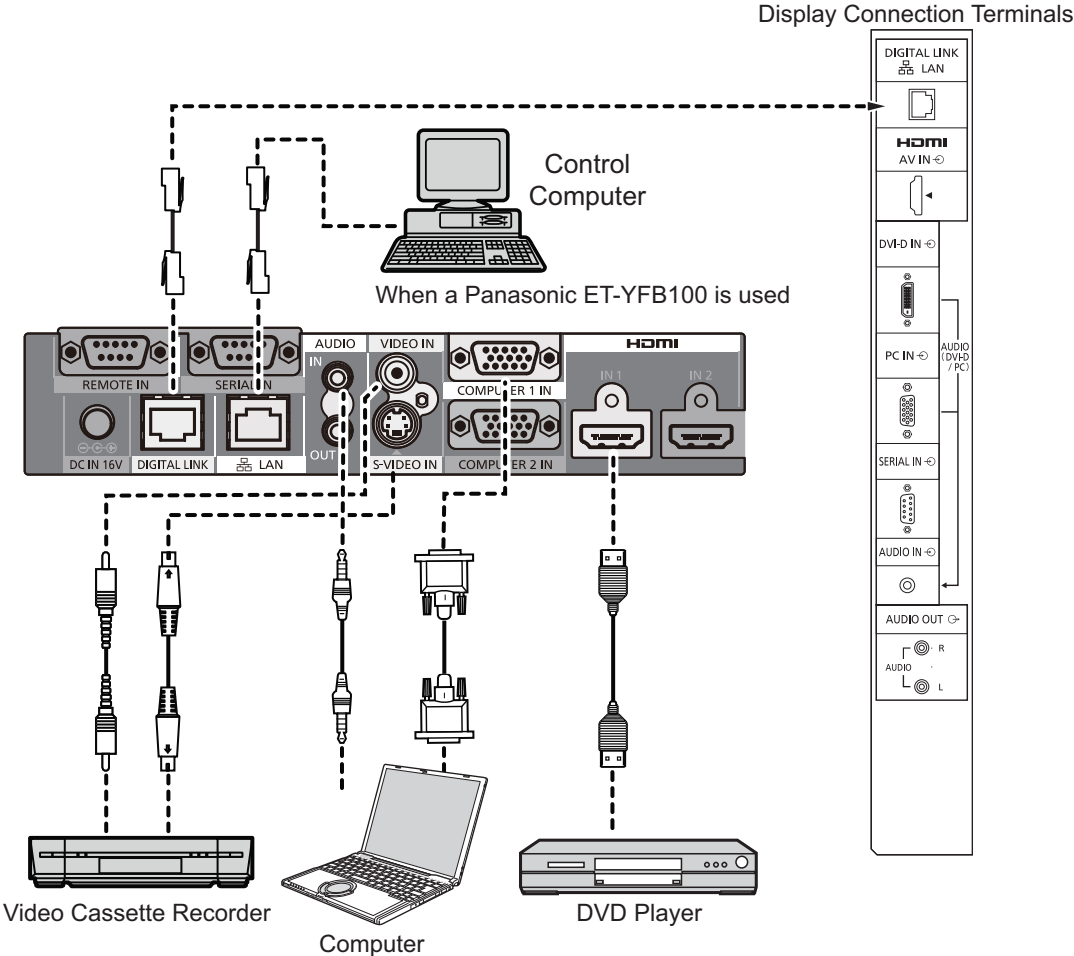

Notes:

- When connecting with DIGITAL LINK, be sure to configure each of the “Network Setup” settings. (see page 43-45)
- For details on precautions related to connecting to the DIGITAL LINK terminals, see “connecting with a twisted pair cable transmitter”. (see page 51)

Power On / Off

Connecting the AC cord plug to the Display.

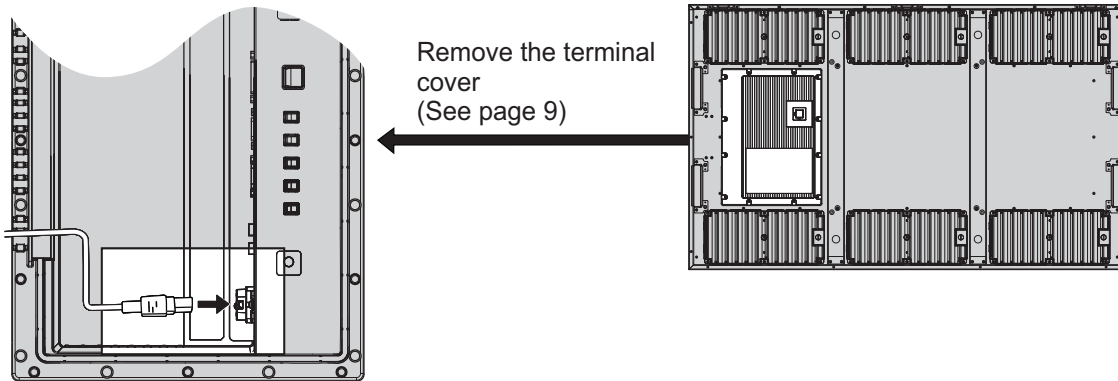

Connecting the plug to the Wall Outlet

Notes:

- Main plug types vary between countries. The power plug shown at right may, therefore, not be the type fitted to your set.
- When disconnecting the AC cord, be absolutely sure to disconnect the AC cord plug at the socket outlet first.

Press the Power switch on the Display to turn the set on: Power-On.

Power Indicator: Green

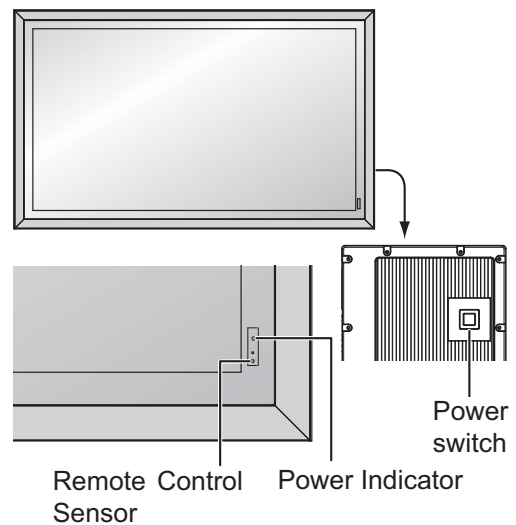

POWER



Press the  button on the remote control to turn the Display off.

Power Indicator: Red (standby)

Press the  button on the remote control to turn the Display on.

Power Indicator: Green

Turn the power to the Display off by pressing the /I switch on the unit, when the Display is on or in standby mode.

Note:

During operation of the power management function, the power indicator turns orange in the power off state.

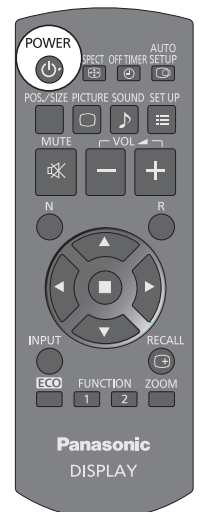

When first switching on the unit

Following screen will be displayed when the unit is turned on for the first time. Select the items with the remote control. Unit buttons are invalid.

OSD Language

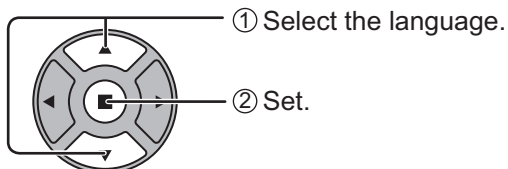

PRESENT TIME Setup

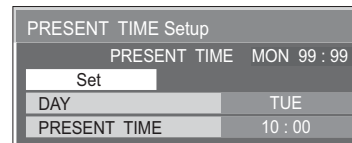
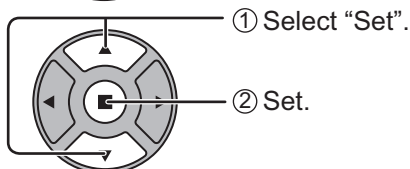
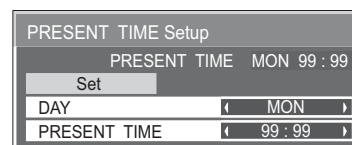
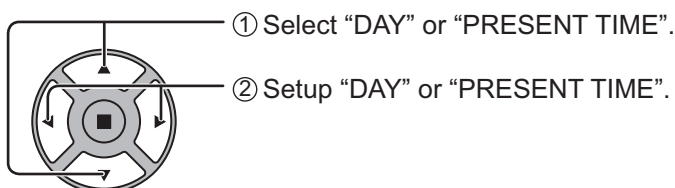

Outdoor mode

Note:

This setting screen is not displayed on TH-47LFX60U and TH-47LFX6NU.

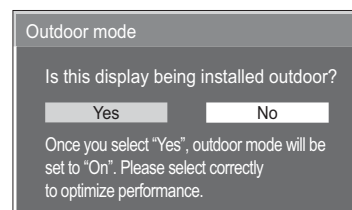
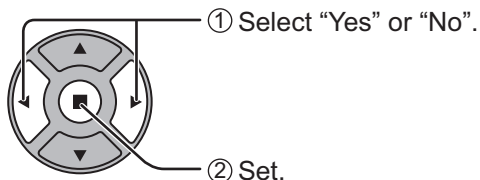

Notes:

- Once the items are set, the screens won't be displayed when switching on the unit next time.
- After the setting, the items can be changed in the following menus.
OSD Language (see page 36)
PRESENT TIME Setup (see page 29)
Outdoor mode (see page 33)

Power ON warning message

The following message may be displayed when turning the unit power ON:

No activity power off Precautions



If "No activity power off" in Setup menu is set to "Enable", a warning message is displayed every time the power is turned ON. (see page 33)

This message display can be set with the following menu: Options menu

Power On Message (see page 48)

Selecting the input signal

INPUT



Press to select the input signal to be played back from the equipment which has been connected to the Display.

Input signals will change as follows:



HDMI: HDMI input terminal in AV IN (HDMI).

PC: PC input terminal in PC IN.

DVI: DVI input terminal in DVI-D IN.

DIGITAL LINK: DIGITAL LINK input to DIGITAL LINK terminal



Note:

Selecting is also possible by pressing the INPUT button on the unit.

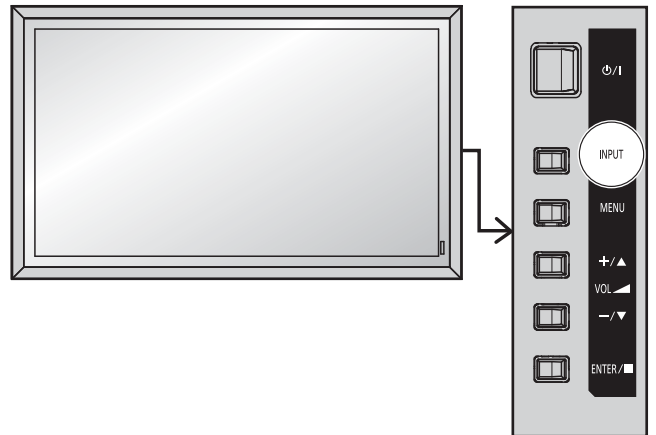

Basic Controls

Main Unit

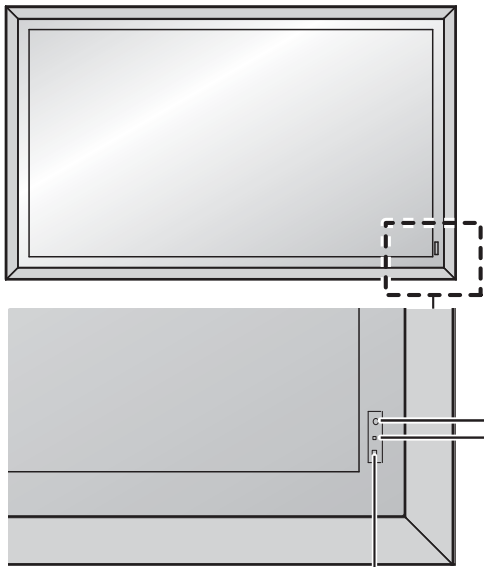

Remote control sensor

Power Indicator

The Power Indicator will light.

- Power-OFF Indicator not illuminated (The unit will still consume some power as long as the power cord is still inserted into the wall outlet.)
- Standby Red
Orange (When the control terminal selection is "LAN" or "RS-232C(DIGITAL LINK)". See page 43)
Orange (When Outdoor mode is set to "ON". See page 33)
- Power-ON Green
- PC Power management (DPMS)
..... Orange (With PC input signal. See page 34)
- DVI-D Power management
..... Orange (With DVI input signal. See page 34)
- When dust has accumulated on the air filters
..... Green and orange blink alternately (See page 5)

Brightness Sensor (see page 34)

Detects the brightness in the viewing environment.

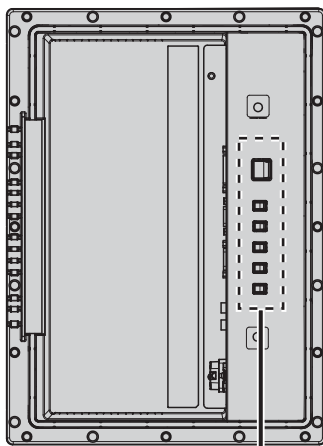

Remove the terminal cover (see page 9)

Outlet (air filter, fan)
(see page 5)

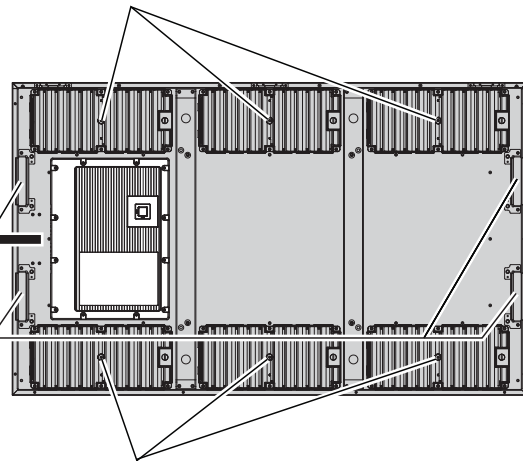

Handle

Inlet (air filter)
(see page 5)

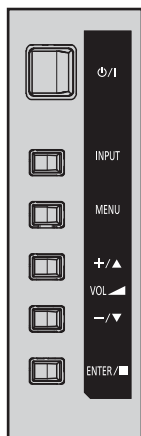

Main Power On / Off Switch

INPUT button (INPUT signal selection)
(see page 18)

MENU Screen ON / OFF

Each time the MENU button is pressed, the menu screen will switch. (see page 23)

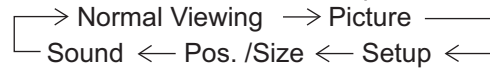

Volume Adjustment

Volume Up "+" Down "-"

When the menu screen is displayed:

"+": press to move the cursor up

"-": press to move the cursor down

(see page 23)

Enter / Aspect button

(see page 21, 23)

Remote Control Transmitter

ACTION button
Press to make selections.

ASPECT button
Press to adjust the aspect.
(see page 21)

Standby (ON / OFF) button
The Display must first be plugged into the wall outlet and turned on at the power switch (see page 16). Press this button to turn the Display On, from Standby mode. Press it again to turn the Display Off to Standby mode.

POS. /SIZE button
(see page 24, 25)

PICTURE button
(see page 26, 27)

Sound mute On / Off
Press this button to mute the sound.
Press again to reactivate sound.
Sound is also reactivated when power is turned off or volume level is changed.

N button
(see page 25, 26, 27, 28)

POSITION buttons

INPUT button
Press to select Input signal sequentially. (see page 18)

ECO MODE (ECO)
Press to change the ECO MODE setup status. (see page 34)

FUNCTION buttons (FUNCTION)
(see page 48)

OFF TIMER button

The Display can be preset to switch to stand-by after a fixed period. The setting changes to 30 minutes, 60 minutes, 90 minutes and 0 minutes (off timer cancelled) each time the button is pressed.

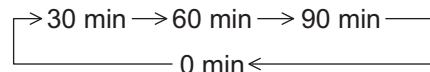

When three minutes remain, "Off timer 3 min" will flash.

The off timer is cancelled if a power interruption occurs.

AUTO SETUP button

Automatically adjusts the position/size of the screen. (see page 24)

SET UP button (see page 29 - 45)

SOUND button (see page 28)

Volume Adjustment

Press the Volume Up "+" or Down "-" button to increase or decrease the sound volume level.

R button (see page 23)

Press the R button to return to previous menu screen.

RECALL button

Press the "RECALL" button to display the current system status.

- ① Input label
- ② Aspect mode (see page 21)
- ③ Air filter conditions (see page 5)
- ④ Off timer

The off timer indicator is displayed only when the off timer has been set.

- ⑤ Clock Display (see page 47)

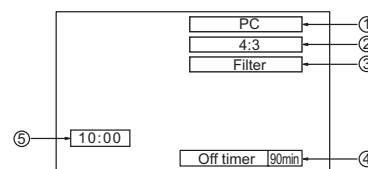

Digital Zoom (see page 22)

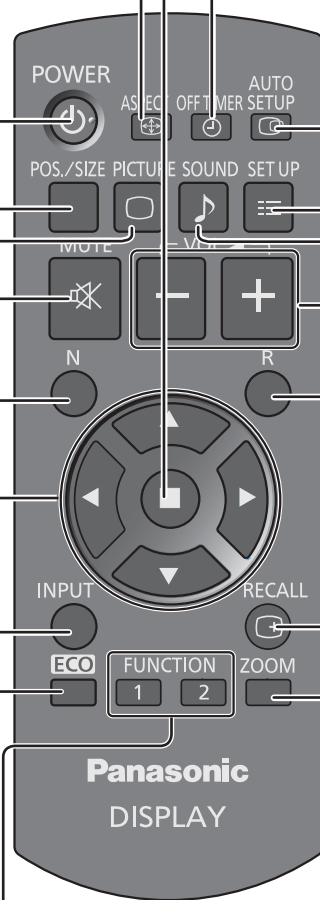

ASPECT Controls

The Display will allow you to enjoy viewing the picture at its maximum size, including wide screen cinema format picture.

Note:

Be aware that if you put the display in a public place for commercial purposes or a public showing and then use the aspect mode select function to shrink or expand the picture, you may be violating the copyright under copyright law. It is prohibited to show or alter the copyrighted materials of other people for commercial purposes without the prior permission of the copyright holder.



ASPECT



Press repeatedly to move through the aspect options:

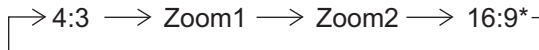

[from the unit]

Right side surface

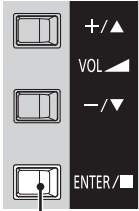

The aspect mode changes each time the ENTER button is pressed.

Note:

The aspect mode is memorized separately for each input terminal.

| Aspect mode | Picture → Enlarged screen | Description |
|-------------|---------------------------|---|
| 16:9* | | The display of the pictures fills the screen. In the case of SD signals, pictures with a 4:3 aspect ratio are enlarged horizontally, and displayed. This mode is suited to displaying anamorphic pictures with a 16:9 aspect ratio. |
| 4:3 | | Pictures with a 4:3 aspect ratio are displayed with their original aspect ratio. Side panels are displayed at the left and right edges of the screen. |
| | | The pictures with a 4:3 aspect ratio among the 16:9 aspect ratio signals are displayed with their original aspect ratio. The left and right edges of the pictures are masked with side panels. |
| Zoom1 | | Letterbox pictures with a 16:9 aspect ratio are enlarged vertically and horizontally so that their display fills the screen. The top and bottom edges of the pictures are cut off. |
| Zoom2 | | Letterbox pictures with a 16:9 aspect ratio are enlarged vertically and horizontally so that their display fills the screen. The top and bottom edges as well as the left and right edges of the pictures are cut off. |

* In "ENGLISH (US)" OSD language, this is displayed as "FULL".

Digital Zoom

This displays an enlargement of the designated part of the displayed image.

1 Display the operation guide.

ZOOM
 Press to access Digital Zoom.
 The operation guide will be displayed.

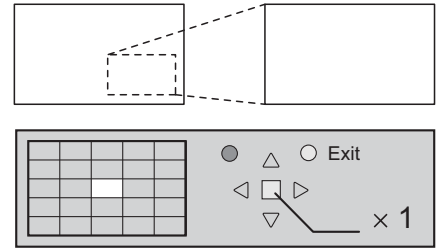

During Digital Zoom, only the following buttons can be operated.

[Remote control]

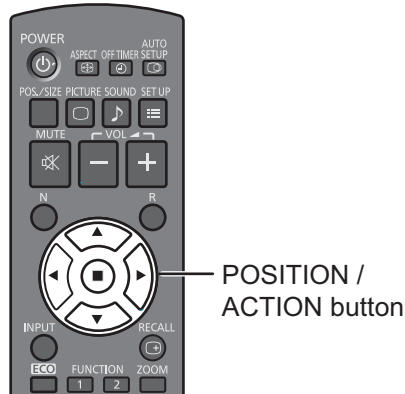

2 Select the area of the image to be enlarged.

Press on the enlargement location to select.
 The cursor will move.

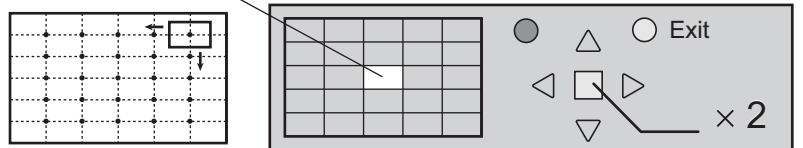

3 Select the magnification required for the enlarged display.

Each time this is pressed, the magnification factor changes.
 This is shown in the image being displayed.

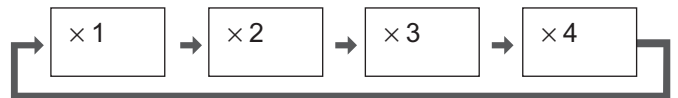

4 Return to normal display (quit Digital Zoom).

R
 Press to exit from the Digital Zoom.

Notes:

- When power goes OFF (including “Off Timer” operation), Digital Zoom terminates.
- The Digital Zoom function cannot be selected while in the following operation state:
 When MULTI DISPLAY Setup is On (see page 37).
 When Screensaver is running (see page 31)
- While Digital Zoom is in operation, “Adjusting Pos. / Size” cannot be used.

On-Screen Menu Displays

Remote Control

Unit

1 Display the menu screen.



Press to select.
(Example: Picture menu)



Press several times.

Each time the MENU button is pressed, the menu screen will switch.

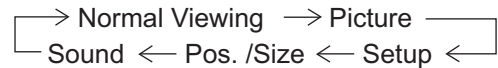

2 Select the item.

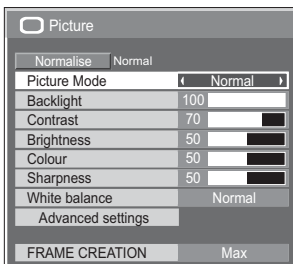

(Example: Picture menu)

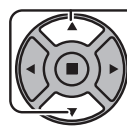

Select.

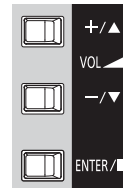

① Select.

② Press.

3 Set.



Adjust.

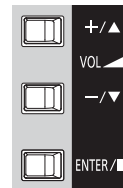

① Adjust.

② Press.

4 Exit the menu.



Press. R
Press O to return to the previous menu.



Press several times.

Menu display list

Note: Menu that cannot be adjusted is grayout. Adjustable menu changes depending on signal, input and menu setting.

Picture menu

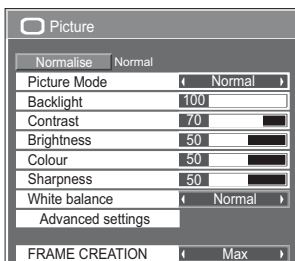

See page 26, 27

Setup menu

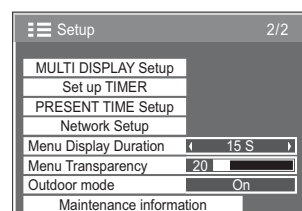
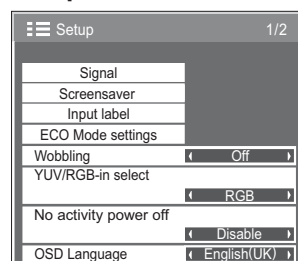

See page 29-45

Pos./Size menu

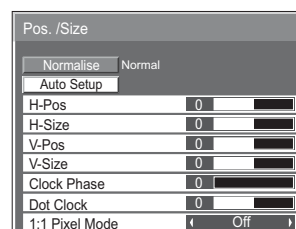

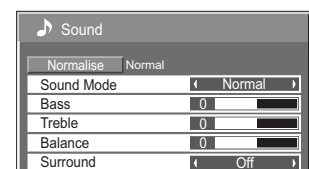

See page 24, 25

Sound menu

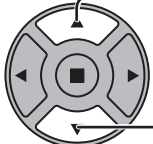
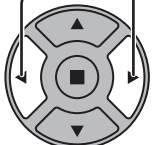

See page 28

Adjusting Pos. /Size

- 1  Press to display the Pos. /Size menu.
- 2  Press to select the menu to adjust.
- 3  Press to adjust the menu.
- 4  Press to exit from adjust mode.

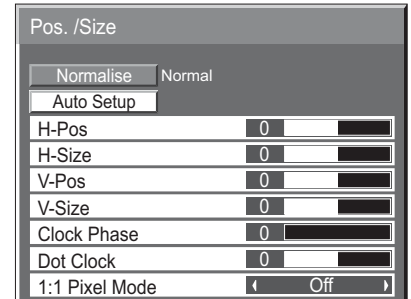

Notes:

Unadjustable items are grayed out.
Adjustable items differ depending on the input signal and the display mode.

Note:

If a "Cue" or "Rew" signal from a VCR or DVD player is received, the picture position will shift up or down. This picture position movement cannot be controlled by the Picture Pos./Size function.

Auto Setup H-Pos/V-Pos, H-Size/V-Size, Dot Clock and Clock Phase are automatically adjusted when the PC signal is received.

This setting only operates when a PC signal is input, and the aspect is "16:9".

Using Remote Control



When  on the remote control is pressed, "Auto Setup" will be executed.

When Auto Setup does not work, "Invalid" is displayed.

Notes:

- Auto Setup may not work when a cropped or dark image is input. In such case, switch to a bright image with borders and other objects are clearly shown, and then try auto setup again.
- Depending on the signal, out of alignment may occur after Auto Setup. Carry out fine tuning for the position/size as required.
- If Auto Setup cannot set properly for vertical frequency 60Hz XGA signal (1024×768@60Hz and 1366×768@60Hz), pre-selecting the individual signal in "XGA Mode" (see page 40) may results in correct Auto Setup.
- Auto Setup does not work well when a signal such as additional information is superimposed out of valid image period or intervals between synchronizing and image signals are short.
- If Auto Setup cannot adjust correctly, select "Normalise" once and press ACTION (■), then adjust Pos. /Size manually.
- If the picture goes off screen in the horizontal direction as a result of performing Auto Setup, perform Dot Clock adjustment.

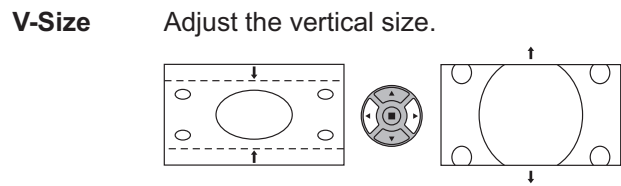
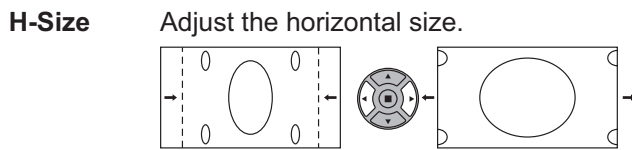
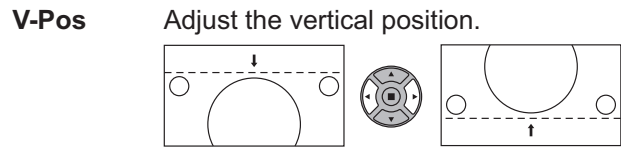
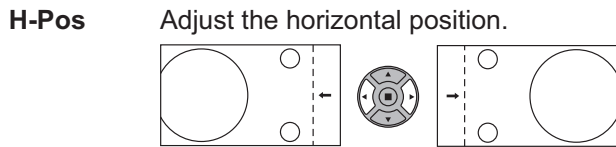

Clock Phase **(During PC input signal)**
Eliminate the flickering and distortion.

Dot Clock **(During PC input signal)**
Periodic striped pattern interference (noise) may occur when a striped pattern is displayed. If this happens, adjust so that any such noise is minimized.

Over scan Turn image over scan On/Off.
Configurable signals are as follows:
525i, 525p, 625i, 625p, 750/60p, 750/50p (DVI, HDMI)

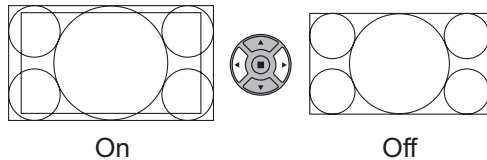

Notes:

- “Off” is effective during only “16:9” aspect mode.
- When “Off” is set, “H-Size” and “V-Size” cannot be adjusted.

1:1 Pixel Mode Adjusts the display size when 1125i or 1125p signal is input.

Notes:

- “On” is effective during only “16:9” aspect mode.
- Select On when you would like to replay 1920 × 1080 input signal.
- Applicable input signal;
1125 (1080) / 50i · 60i · 24psF · 24p · 25p · 30p · 50p · 60p
- Select Off when flickering is shown around the image.
- H-Size and V-Size cannot be adjusted when On is selected.

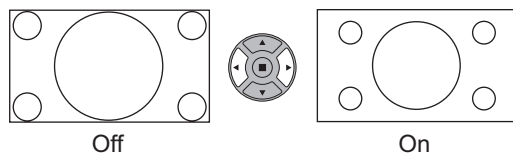

Helpful Hint (/ **Normalise** Normalisation)

While the Pos. / Size display is active, if either the N button on the remote control is pressed at any time or the ACTION (■) button is pressed during “Normalise”, then all adjustment values (except “Clock Phase” and “Dot Clock”) are returned to the factory settings.

Picture Adjustments

1  Press to display the Picture menu.

2 Select to adjust each item.

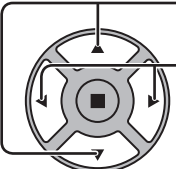
 Press to select the menu to adjust.
 Select the desired level by looking at the picture behind the menu.

Note:
 Menu that cannot be adjusted is grayout. Adjustable menu changes depending on signal, input and menu setting.

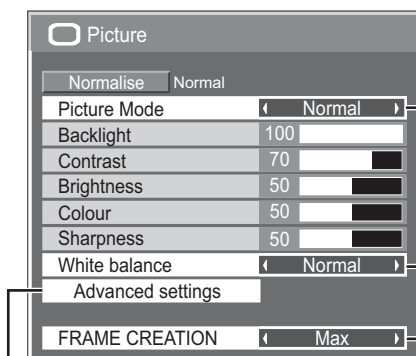

Press “◀” or “▶” button to switch between modes.



Normal*
 For viewing in standard (evening lighting) environments.
 * In “ENGLISH (US)” OSD language, this is displayed as “STANDARD”.

Dynamic
 For viewing in brighter environments.

Cinema
 For use in viewing tone-focused pictures with brightness reduced.

Note:
 If you would like to change the picture and colour of the selected Picture menu to something else, adjust using the items in the Picture menu. (see next page)
 • In “ENGLISH (US)” OSD language, the “Picture Mode” is displayed as “PICTURE MENU”.



Press to enter Advanced settings .

Advanced settings
 Enables fine picture adjustment at a professional level (see next page).

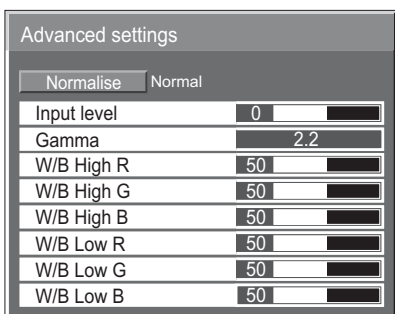

Press “◀” or “▶” button to switch between modes.



• In “ENGLISH (US)” OSD language, the “White balance” is displayed as “COLOR TEMP”.

FRAME CREATION

Improves motion picture quality by reducing motion blur.
 Press the left ◀ or right ▶ button to switch between modes.













Notes:

- The mode is memorized per input terminal.
- Even if “Normalise” is selected, the Normal setting will not be restored.
- The picture and menu will disappear for a moment if you switch the mode to Off, or switch from Off to another mode.

Helpful Hint (/ Normalise Normalisation)

While the “Picture” menu is displayed, if either the N button on the remote control is pressed at any time or the ACTION () button is pressed during “Normalise”, then all adjustment values are returned to the factory settings.

















| Item | Effect | Adjustments |
|-------------------|--|--|
| Backlight |   Darker Brighter | Adjusts luminance of the back light. |
| Contrast* |   Less More | Selects the proper brightness and density for the room. |
| Brightness |   Darker Brighter | Adjusts for easier viewing of dark pictures such as night scenes and black hair. |
| Colour |   Less More | Adjusts colour saturation. |
| Sharpness |   Less More | Adjusts picture sharpness. |

Notes:

- You can change the level of each function (Backlight, Contrast, Brightness, Sharpness) for each Picture Mode.
- The setting details for normal, dynamic and cinema respectively are memorized separately for each input terminal.
- “Backlight” can be adjusted when “ECO Mode” is set to “Custom” and “Power save” to “Off”. (see page 34)
- “Colour” can be adjusted when the following inputs are selected:
HDMI, DVI, or DIGITAL LINK

* In “ENGLISH (US)” OSD language, this is displayed as “PICTURE”.

Advanced settings

| Item | Effect | Details |
|--------------------|--|---|
| Input level |   Less More | Adjustment of parts which are extremely bright and hard to see. |
| Gamma |   Down Up | S Curve \longleftrightarrow 2.0 \longleftrightarrow 2.2 \longleftrightarrow 2.6 |
| W/B High R |   Less More | Adjusts the white balance for light red areas. |
| W/B High G |   Less More | Adjusts the white balance for light green areas. |
| W/B High B |   Less More | Adjusts the white balance for light blue areas. |
| W/B Low R |   Less More | Adjusts the white balance for dark red areas. |
| W/B Low G |   Less More | Adjusts the white balance for dark green areas. |
| W/B Low B |   Less More | Adjusts the white balance for dark blue areas. |

Notes:

- Carry out “W/B” adjustment as follows.
 1. Adjust the white balance of the bright sections using the “W/B High R”, “W/B High G” and “W/B High B” settings.
 2. Adjust the white balance of the dark sections using the “W/B Low R”, “W/B Low G” and “W/B Low B” settings.
 3. Repeat steps 1 and 2 to adjust.
 Steps 1 and 2 affect each other’s settings, so repeat each step in turn to make the adjustment.
- The adjustment values are memorized separately for each input terminal.
- The adjustment range values should be used as an adjustment reference.

Helpful Hint (/ **Normalise** **Normalisation**)

On the remote control unit, while the “Advanced settings” menu is displayed, if either the N button is pressed at any time or the ACTION () button is pressed during “Normalise”, then all adjustment values are returned to the factory settings.

Sound Adjustment

1  Press to display the Sound menu.

2 Select to adjust each item.

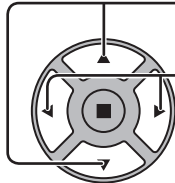
 Press to select the menu to adjust.
Select the desired level by listening to the sound.

3  Press to exit from adjust mode.

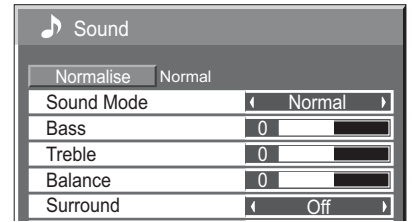

| Item | Details |
|---------------------|---|
| Sound Mode*1 | Normal*2: Emits the original sound. Dynamic: Accentuates sharp sound. Clear: Attenuates human voice. |
| Bass | Adjusts low pitch sounds. |
| Treble | Adjusts high pitch sounds. |
| Balance | Adjusts left and right volumes. |
| Surround | Select On or Off. |

Note: Bass, Treble and Surround settings are memorized separately for each Sound Mode.

*1 In "ENGLISH (US)" OSD language, this is displayed as "AUDIO MENU".

*2 In "ENGLISH (US)" OSD language, this is displayed as "STANDARD".

Helpful Hint (/ Normalisation)

While the "Sound" menu is displayed, if either the N button on the remote control is pressed at any time or the ACTION (■) button is pressed during "Normalise", then all adjustment values are returned to the factory settings.

PRESENT TIME Setup / Set up TIMER

The timer can switch the Display On or Off.

Before attempting Timer Set, confirm the PRESENT TIME and adjust if necessary. Then set POWER ON Time / POWER OFF Time.

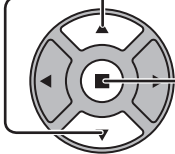
- 1  Press to display the Setup menu.
- 2  Press to select Set up TIMER or PRESENT TIME Setup.
Press to display the Set up TIMER screen or PRESENT TIME Setup screen.

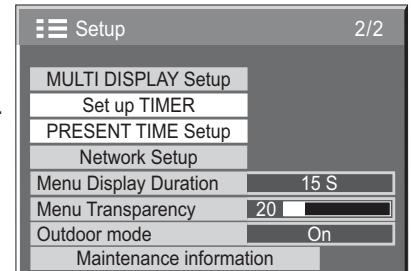

PRESENT TIME Setup

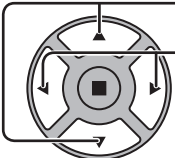
- 1  Press to select DAY or PRESENT TIME*.
Press to setup DAY or PRESENT TIME*.
▶ button: Forward
◀ button: Back
Notes:
 - Pressing “◀” or “▶” button once changes PRESENT TIME 1 minute.
 - Pressing “◀” or “▶” button continuously changes PRESENT TIME by 15 minutes.

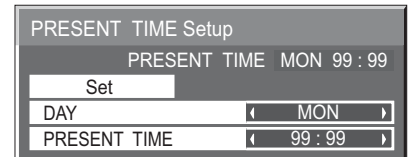

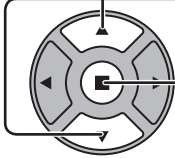
- 2  Press to select Set.
Press to store PRESENT TIME Setup.
Notes:
 - Set cannot be selected unless PRESENT TIME* is set.
 - Unless setting the present time other than “99:99”, “DAY” and “PRESENT TIME”* can not be set.
 - The settings of “DAY” and “PRESENT TIME”* are reset when leaving the display turned off for about 7 days for the following reasons:
 - Pressing ⏻/| switch of the unit to turn off the display.
 - Disconnecting the AC cord.
 - Interruption of power supply.
 - * In “ENGLISH (US)” OSD language, this is displayed as “PRESENT TIME OF DAY”.

Set up TIMER

Set the program for turning the power On/Off and select the input signal at the specified time. Up to 20 programs can be set.

[Setting Example]

Program 1, Every Monday, 12:00, Power On, Input: HDMI

| Set up TIMER | |
|-------------------------|----------|
| PRESENT TIME MON 0 : 03 | |
| Program | 1 |
| Timer Function | On |
| Day | MON |
| Power Mode | Power On |
| Time | 12 : 00 |
| Input | HDMI |

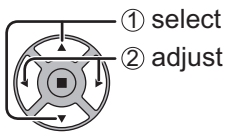

① select
② adjust

- 1 Set the program number.
- 2 To execute the program, set to "On".
The program is disabled when "Off" is set.
- 3 Set the day.
The program is executed every day when "Everyday" is set.
- 4 Set the power On/Off.
- 5 Set the time.
Pressing "◀" or "▶" button once changes "Time" 1 minute.
Pressing "◀" or "▶" button continuously changes "Time" by 15 minutes.
- 6 Set the input.

Notes:

- This function cannot be set unless "PRESENT TIME Setup" is set.
- If more than one programs are set for the same time, only the program with the smallest program number is enabled.

Screensaver (For preventing image retention)

Do not display a still picture, especially in 4:3 mode, for any length of time.

If the display must remain on, a Screensaver should be used.

When the screen saver is operating, the following 5 patterns are displayed full screen for 5 seconds each.

Black→Dark Gray→Gray→Light Gray→White

1  Press to display the Setup menu.

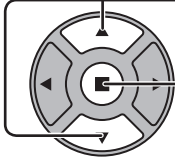
2  Press to select Screensaver.
Press to display Screensaver screen.

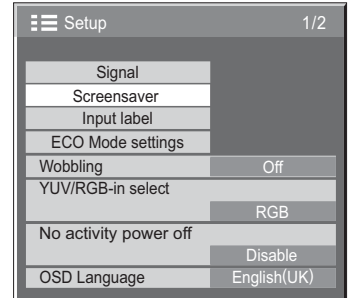

3 Mode selection

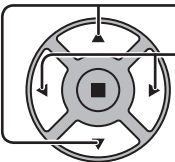
 Press to select Mode.
Press to select each mode items.

- Off
- ↕
- Interval : Operates when Periodic Time and Operating Time are setup and those times arrive.
- ↕
- Time Designation* : Operates when Start Time and Finish Time are setup and those times arrive.
* In "ENGLISH (US)" OSD language, this is displayed as "TIME OF DAY".
- ↕
- Standby after SCR Saver: Operates while Screensaver duration, and display enters standby mode.
- ↕
- On : Operates when Start is selected and the ACTION (■) button is pressed.

4 Start setting

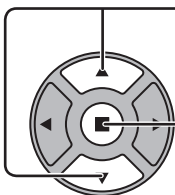
 When the Mode is set to On, press to select Start.
Press to start Screensaver.

The menu screen will disappear and the Screensaver will be activated. **To stop the Screensaver under On, press the R button or any buttons on the main unit.**

Note: When the display is turned off, the Screensaver will be deactivated.

Setup of Screensaver Time

After selecting Time Designation, Interval or Standby after SCR Saver, the relevant Time Setup will become available for selection and the Operating Time may be set. (Time cannot be set when "Mode" is "On" or "Off".)

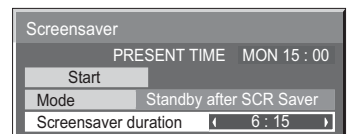
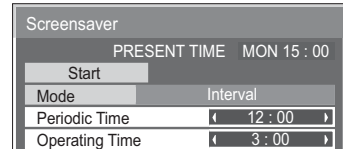
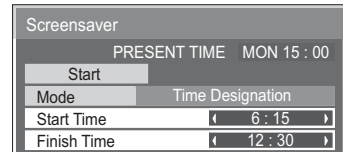
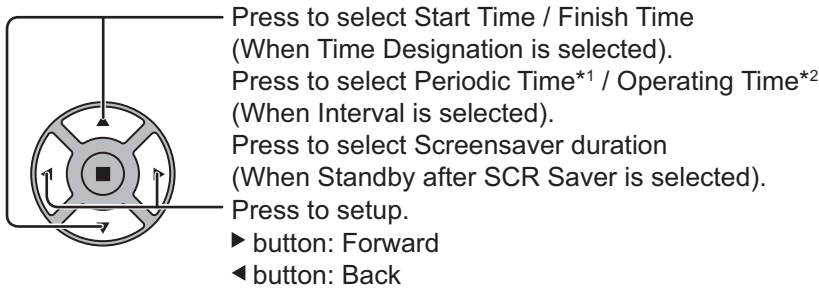

*¹ In "ENGLISH (US)" OSD language, this is displayed as "SHOW DURATION".
*² In "ENGLISH (US)" OSD language, this is displayed as "SAVER DURATION".

Notes:

- Pressing "◀" or "▶" button once changes the Time 1 minute.
[However, switching occurs every 15 minutes when Periodic Time is selected.]
- Pressing "◀" or "▶" button continuously changes the Time by 15 minutes.
- "Screensaver duration" of the "Standby after SCR Saver" can be set from 0:00 to 23:59. When this is set to "0:00", "Standby after SCR Saver" will not be activated.

Note: Timer function will not work unless "PRESENT TIME" is set.

Wobbling

Automatically shifts the display image (therefore unnoticeable to the eye) to prevent image retention of sharper contour of image.

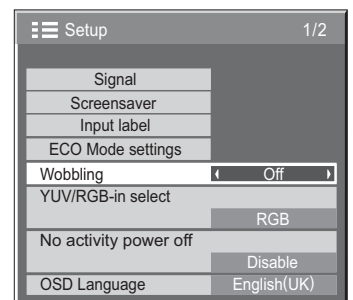
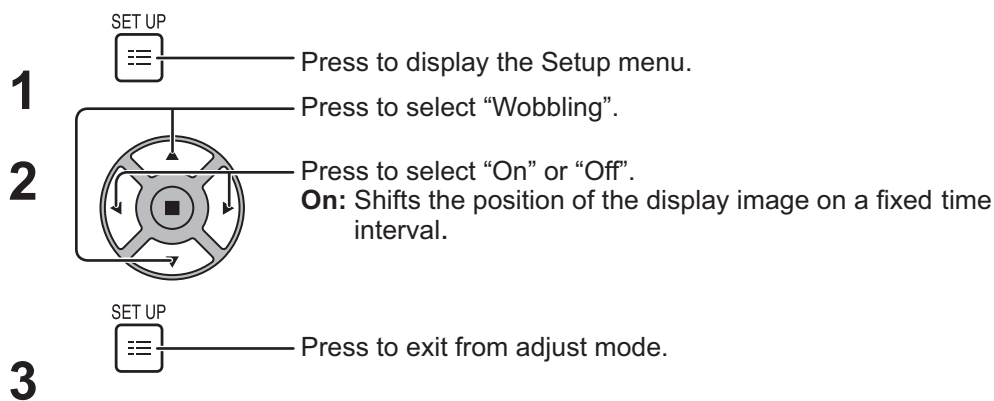

Notes:

- If "MULTI DISPLAY Setup" is set to "On", this function does not operate.
- When this function is operating, part of the screen may appear to be missing.

No activity power off

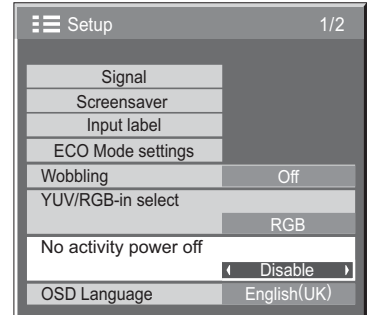
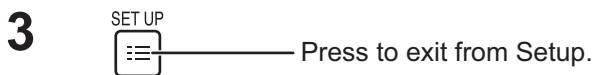
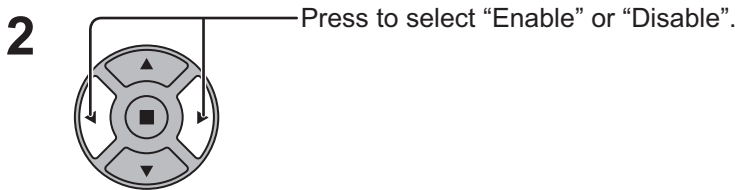
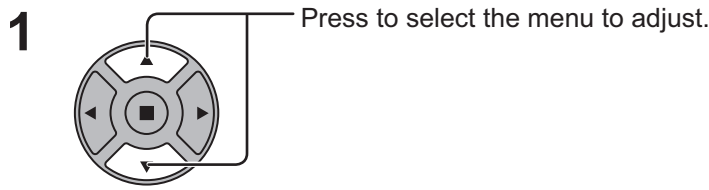

When this function is set to "Enable", the power is turned off (standby) automatically when there is no operation of the Display for 4 hours. Starting from 3 minutes before the turn off, the remaining time will be displayed. When the power is turned off due to this function, a message "Last turn off due to 'No activity power off'." is displayed next time the power is turned on.

Note:

During the screensaver is running, this function is disabled.

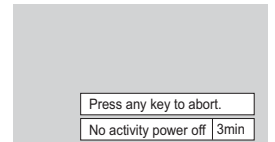

Outdoor mode

These settings are configured to preserve the quality of the Display when it is used in a high or low temperature environment.

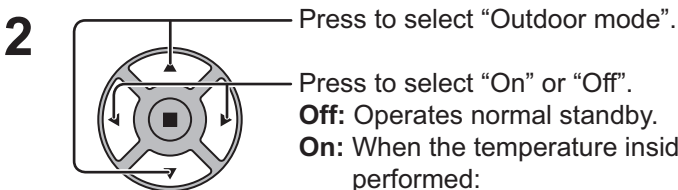
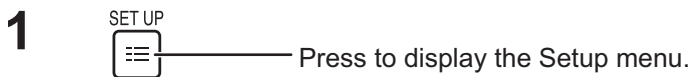

Off: Operates normal standby.

On: When the temperature inside the Display becomes low, the following operations are performed:

1. Turn on the back light to prevent a decrease of temperature during standby.
 2. When pictures are displayed and the "Local Dimming" function is set to "On", the operations are the same as when it is set to "Off".
- Local Dimming → page 47



When this function is set to "On", the following message appears at standby.

OUTDOOR MODE IS ACTIVE.

Notes:

- Do not unplug the power cable while using the Display with this function "On".
- When this function is set to "On", the power consumption at standby is approx. 40W.
- The fans spin while this is set to "On" even if the Display is in standby mode.
- Turn this function "On" to use this product when it is directly exposed to sunlight.

ECO Mode settings

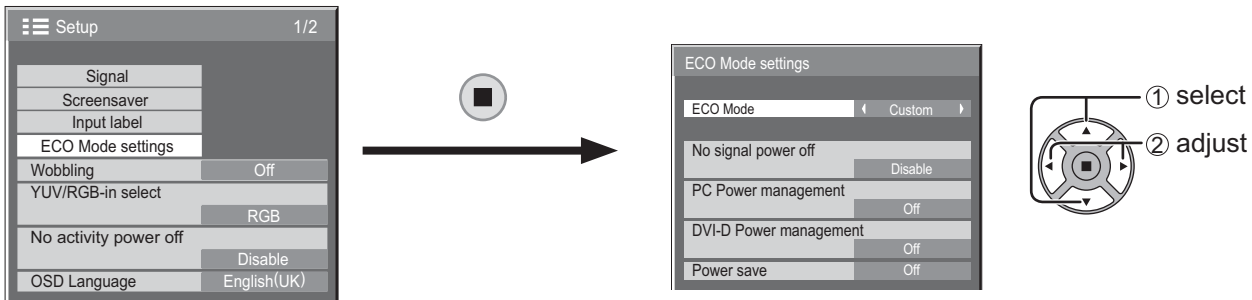

ECO Mode

Custom: The menu of power consumption reduction is individually set.

On: The following fixed values are set to the menu of power consumption reduction. Individual setting is not available.

- No Signal power off: Enable
- PC Power management: On
- DVI-D Power management: On
- Power save: Sensor

Using Remote Control

When **ECO** is pressed, the "ECO Mode" setting changes.

ECO Mode On

Custom settings

The menu of the power consumption reduction is individually set. This setting is enabled when "ECO Mode" is set to "Custom".

No signal power off

Equipment power supply is turned Off when there is no signal.

When this is set to "Enable", the power supply of the unit goes Off 10 minutes after the input signals stop.

PC Power management

When this function is set to On, it operates under the following conditions to turn the power on or off automatically.

When no pictures are detected for 30 or so seconds during PC signal input:

→ Power is turned off (standby); the power indicator lights up orange.

When pictures are subsequently detected:

→ Power is turned on; the power indicator lights up green.

Notes:

- This function operates only during input from PC IN terminal.
- This function is effective when "Sync" is set to "Auto" and during normal viewing.

DVI-D Power management

When this function is set to On, it operates under the following conditions to turn the power on or off automatically.

When no pictures (sync signal) are detected for 30 or so seconds during DVI signal input:

→ Power is turned off (standby); the power indicator lights up orange.

When pictures (sync signal) are subsequently detected:

→ Power is turned on; the power indicator lights up green.

Note:

This function operates only during DVI signal input.

Power save

This function adjusts the brightness of the backlight to reduce power consumption.

Off: This function does not operate.

On: Backlight brightness is reduced.



Sensor: The backlight brightness is automatically adjusted according to the viewing environment.

Note:

When this function is set to "On" or "Sensor", the "Backlight" setting in the Picture menu is disabled.

Customizing the Input labels

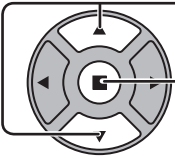
This function can change the label of the Input signal to be displayed. (see page 18)

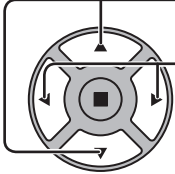
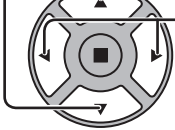
- 1  Press to display the Setup menu.
- 2  Press to select Input label.
 Press to display the Input label screen.
- 3  Press to select image input.
 Press to change input label.

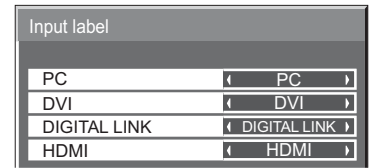
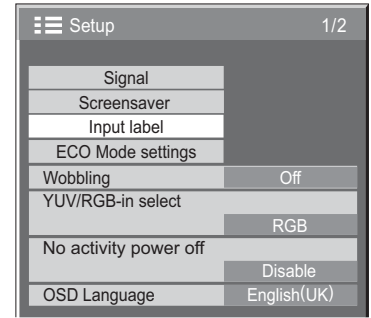

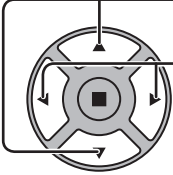
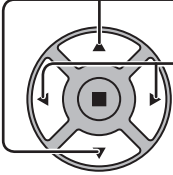

Image input
 [PC]
 [DVI]
 [DIGITAL LINK]
 [HDMI]

Input label
 PC / DVD1 / DVD2 / DVD3 / Blu-ray1 / Blu-ray2 / Blu-ray3 / CATV / VCR / STB / (Skip)
 DVI / DVD1 / DVD2 / DVD3 / Blu-ray1 / Blu-ray2 / Blu-ray3 / CATV / VCR / STB / (Skip)
 DIGITAL LINK / DVD1 / DVD2 / DVD3 / Blu-ray1 / Blu-ray2 / Blu-ray3 / CATV / VCR / STB / (Skip)
 HDMI / DVD1 / DVD2 / DVD3 / Blu-ray1 / Blu-ray2 / Blu-ray3 / CATV / VCR / STB / (Skip)

(Skip): The INPUT button press will skip its input.

Selecting the On-Screen Menu Language

-  Press to display the Setup menu.
-  Press to select the OSD Language.
 Press to select your preferred language.

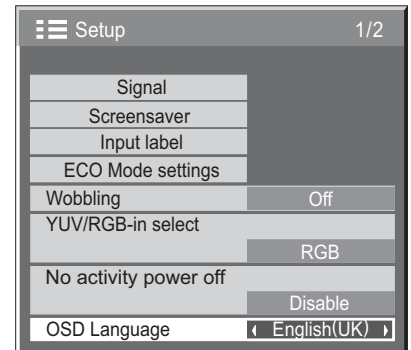

■ Selectable languages

- English (UK)
- ↕
- Deutsch
- ↕
- Français
- ↕
- Italiano
- ↕
- Español
- ↕
- ENGLISH (US)
- ↕
- 中文.....(Chinese)
- ↕
- 日本語.....(Japanese)
- ↕
- Русский.....(Russian)

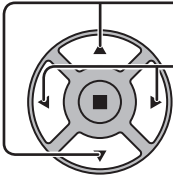
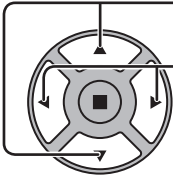
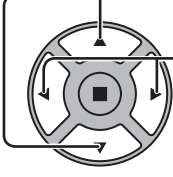
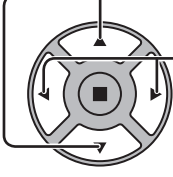

Customizing the On-Screen Menu Display

Set the display time and background transparency of the on-screen menu display.

-  Press to display the Setup menu.
-  Press to select "Menu Display Duration".
 Press to adjust the display duration.
-  Press to select "Menu Transparency".
 Press to adjust the transparency.
-  Press to exit from adjust mode.

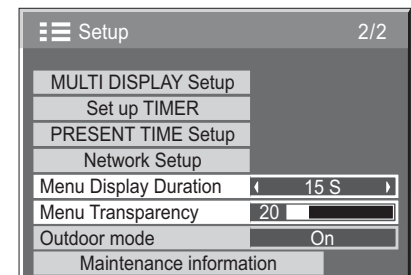

Setup for MULTI DISPLAY

By lining up the Displays in groups, for example, as illustrated below, an enlarged picture may be displayed across all screens.

For this mode of operation, each display has to be set up with a Display number to determine its location.

(Example)

group of 4 (2 × 2)



group of 9 (3 × 3)



group of 16 (4 × 4)





group of 25 (5 × 5)

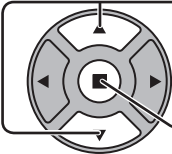
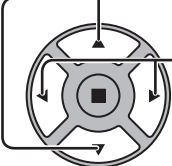

How to Setup MULTI DISPLAY

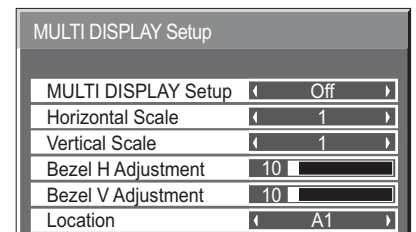
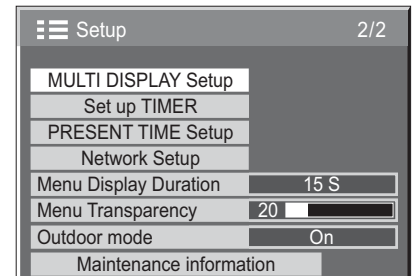
- 1  Press to display the Setup menu.
- 2  Press to select the MULTI DISPLAY Setup.
Press to display the "MULTI DISPLAY Setup" menu.
- 3  Press to select the MULTI DISPLAY Setup.
Press to select "On" or "Off".



| Item | Details |
|--|--|
| MULTI DISPLAY Setup | Select "On" or "Off". |
| Horizontal Scale | Select "1", "2", "3", "4", "5". |
| Vertical Scale | Select "1", "2", "3", "4", "5". |
| Bezel H Adjustment Bezel V Adjustment | <p>Areas of the image that are hidden by the joint sections are adjusted both horizontally and vertically (0~100).</p> <div style="display: flex; justify-content: space-around;"> <div style="text-align: center;"> <p>To show joints between displays.</p>  <p>Example</p> <p>Suitable for still image display. Setting value: 0</p> </div> <div style="text-align: center;"> <p>To hide joints between displays.</p>  <p>Example</p> <p>Suitable for moving image display. Setting value: 100</p> </div> </div> |

Setup for MULTI DISPLAY

| Item | Details | | | | | | | | | | | | | | | | | | | | | | | | | | | | | | | | | | | | | | | | | | | | | | | | | | | | | | | | | |
|-----------------|--|----|----|----|----|----|----|----|----|----|----|----|----|----|----|----|----|----|----|----|----|----|----|----|----|----|----|----|----|----|----|----|----|----|----|----|----|----|----|----|----|----|----|----|----|----|----|----|----|----|----|----|----|----|----|----|----|----|
| | Select the required arrangement number. (A1-E5 : Refer to the following) Display Number locations for each arrangement. (Examples) | | | | | | | | | | | | | | | | | | | | | | | | | | | | | | | | | | | | | | | | | | | | | | | | | | | | | | | | | |
| Location | <div style="display: flex; justify-content: space-around; align-items: flex-start;"> <div style="text-align: center;"> <p>(2 × 1)</p> <table border="1" style="margin: 0 auto;"> <tr><td>A1</td><td>A2</td></tr> </table> </div> <div style="text-align: center;"> <p>(2 × 3)</p> <table border="1" style="margin: 0 auto;"> <tr><td>A1</td><td>A2</td></tr> <tr><td>B1</td><td>B2</td></tr> <tr><td>C1</td><td>C2</td></tr> </table> </div> <div style="text-align: center;"> <p>(4 × 2)</p> <table border="1" style="margin: 0 auto;"> <tr><td>A1</td><td>A2</td><td>A3</td><td>A4</td></tr> <tr><td>B1</td><td>B2</td><td>B3</td><td>B4</td></tr> </table> </div> <div style="text-align: center;"> <p>(4 × 4)</p> <table border="1" style="margin: 0 auto;"> <tr><td>A1</td><td>A2</td><td>A3</td><td>A4</td></tr> <tr><td>B1</td><td>B2</td><td>B3</td><td>B4</td></tr> <tr><td>C1</td><td>C2</td><td>C3</td><td>C4</td></tr> <tr><td>D1</td><td>D2</td><td>D3</td><td>D4</td></tr> </table> </div> <div style="text-align: center;"> <p>(5 × 5)</p> <table border="1" style="margin: 0 auto;"> <tr><td>A1</td><td>A2</td><td>A3</td><td>A4</td><td>A5</td></tr> <tr><td>B1</td><td>B2</td><td>B3</td><td>B4</td><td>B5</td></tr> <tr><td>C1</td><td>C2</td><td>C3</td><td>C4</td><td>C5</td></tr> <tr><td>D1</td><td>D2</td><td>D3</td><td>D4</td><td>D5</td></tr> <tr><td>E1</td><td>E2</td><td>E3</td><td>E4</td><td>E5</td></tr> </table> </div> </div> | A1 | A2 | A1 | A2 | B1 | B2 | C1 | C2 | A1 | A2 | A3 | A4 | B1 | B2 | B3 | B4 | A1 | A2 | A3 | A4 | B1 | B2 | B3 | B4 | C1 | C2 | C3 | C4 | D1 | D2 | D3 | D4 | A1 | A2 | A3 | A4 | A5 | B1 | B2 | B3 | B4 | B5 | C1 | C2 | C3 | C4 | C5 | D1 | D2 | D3 | D4 | D5 | E1 | E2 | E3 | E4 | E5 |
| A1 | A2 | | | | | | | | | | | | | | | | | | | | | | | | | | | | | | | | | | | | | | | | | | | | | | | | | | | | | | | | | |
| A1 | A2 | | | | | | | | | | | | | | | | | | | | | | | | | | | | | | | | | | | | | | | | | | | | | | | | | | | | | | | | | |
| B1 | B2 | | | | | | | | | | | | | | | | | | | | | | | | | | | | | | | | | | | | | | | | | | | | | | | | | | | | | | | | | |
| C1 | C2 | | | | | | | | | | | | | | | | | | | | | | | | | | | | | | | | | | | | | | | | | | | | | | | | | | | | | | | | | |
| A1 | A2 | A3 | A4 | | | | | | | | | | | | | | | | | | | | | | | | | | | | | | | | | | | | | | | | | | | | | | | | | | | | | | | |
| B1 | B2 | B3 | B4 | | | | | | | | | | | | | | | | | | | | | | | | | | | | | | | | | | | | | | | | | | | | | | | | | | | | | | | |
| A1 | A2 | A3 | A4 | | | | | | | | | | | | | | | | | | | | | | | | | | | | | | | | | | | | | | | | | | | | | | | | | | | | | | | |
| B1 | B2 | B3 | B4 | | | | | | | | | | | | | | | | | | | | | | | | | | | | | | | | | | | | | | | | | | | | | | | | | | | | | | | |
| C1 | C2 | C3 | C4 | | | | | | | | | | | | | | | | | | | | | | | | | | | | | | | | | | | | | | | | | | | | | | | | | | | | | | | |
| D1 | D2 | D3 | D4 | | | | | | | | | | | | | | | | | | | | | | | | | | | | | | | | | | | | | | | | | | | | | | | | | | | | | | | |
| A1 | A2 | A3 | A4 | A5 | | | | | | | | | | | | | | | | | | | | | | | | | | | | | | | | | | | | | | | | | | | | | | | | | | | | | | |
| B1 | B2 | B3 | B4 | B5 | | | | | | | | | | | | | | | | | | | | | | | | | | | | | | | | | | | | | | | | | | | | | | | | | | | | | | |
| C1 | C2 | C3 | C4 | C5 | | | | | | | | | | | | | | | | | | | | | | | | | | | | | | | | | | | | | | | | | | | | | | | | | | | | | | |
| D1 | D2 | D3 | D4 | D5 | | | | | | | | | | | | | | | | | | | | | | | | | | | | | | | | | | | | | | | | | | | | | | | | | | | | | | |
| E1 | E2 | E3 | E4 | E5 | | | | | | | | | | | | | | | | | | | | | | | | | | | | | | | | | | | | | | | | | | | | | | | | | | | | | | |

- 4**  Press to exit from Setup.

ID Remote Control Function









You can set the remote control ID when you want to use this remote control on one of several different displays.

Note:

To operate this function, please purchase ID remote controller sold separately.

Object model : EUR7636090R (Europe)

EUR7636070R (Other countries)

- 1** Switch  to  on the right side.
- 2** Press the  button on the remote control.
- 3** Press one of  - ,  for the tens digit setting.
- 4** Press one of  - ,  for the units digit setting.

Notes:

- The numbers in 2, 3 and 4 should be set up quickly.
- Adjustable ID number range is 0 - 99.
- If a number button is pressed more than two times, the first two numbers become the ID number for the remote control.

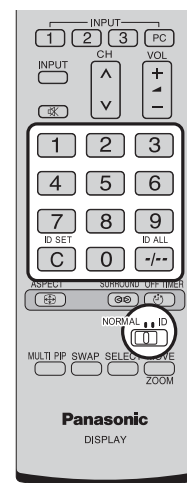

ID remote control button operation

The operation is the same as normal remote control except for the  button.

ID Cancellation

Press  button on remote control. (This has the same effect as pressing the , ,  buttons at the same time.)

Notes:

- Set the Remote ID "On" to operate the ID remote control.
If Remote ID is set to "On", you can use the remote control without identical ID number during option menu display. (see page 47)
- The ID remote control cannot be used when ID select is set to anything other than 0, and the remote control ID is not the same as the ID select number (see page 47).

Setup for Input Signals

YUV / RGB-in select

Select to match the signals from the source connected to DVI-D IN terminal.

YUV signals ⇔ "YUV"

RGB signals ⇔ "RGB"

1  Press to display the Setup menu.

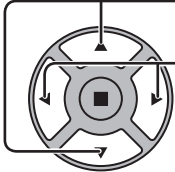
2  Press to select the "YUV / RGB-in select".
Press to select the desired mode.
YUV ← → RGB

3  Press to exit from adjust mode.

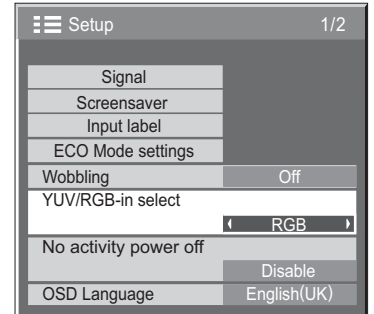

Signal menu

Note:

"Signal" setup menu displays a different setting condition for each input signal.

1  Press to display the Setup menu.

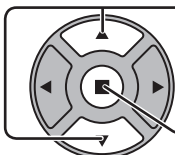
2  Press to select the "Signal".
Press to display the Signal menu.

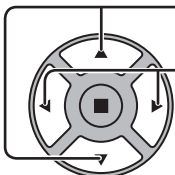
3  Press to select the menu to adjust.
Press to adjust the menu.

4  Press to exit from adjust mode.

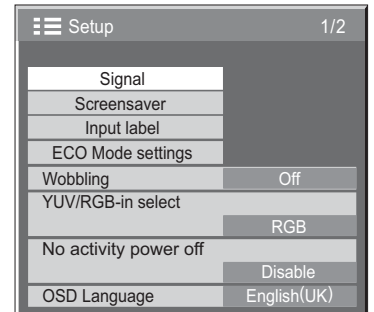

For Digital

| | |
|--------------------|--------------|
| Signal [Digital] | |
| Cinema reality | Off |
| HDMI Range | Auto |
| H-Freq. | 63.98 kHz |
| V-Freq. | 60.02 Hz |
| Dot Clock Freq. | 108.0 MHz |
| Signal Format | 1280×1024/60 |

↓ Press ACTION (■) button
For PC

| | |
|----------------|--------------|
| Signal [RGB] | |
| Sync | Auto |
| Cinema reality | Off |
| XGA Mode | 1024×768 |
| H-Freq. | 63.98 kHz |
| V-Freq. | 60.02 Hz |
| Signal Format | 1280×1024/60 |

Cinema reality*

Cinema reality*:

When on, the display attempts to reproduce a more natural interpretation of sources such as movie pictures, which are recorded at 24 frames per second. If the picture is not stable, turn the setting to off.

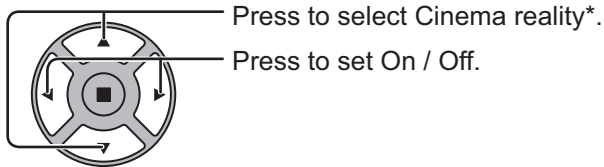

* In "ENGLISH (US)" OSD language, this is displayed as "3:2 PULLDOWN".

XGA Mode

This menu is displayed when the input signal is analog. This menu sets two types of XGA signals with 60Hz vertical frequency having different aspect ratios and sampling rates (1,024 × 768 @ 60Hz and 1,366 × 768 @ 60Hz). When a 1,280 × 768 @ 60Hz input signal is automatically detected, the image is processed as a 1,280 × 768 @ 60Hz XGA input signal irrespective of this setting.

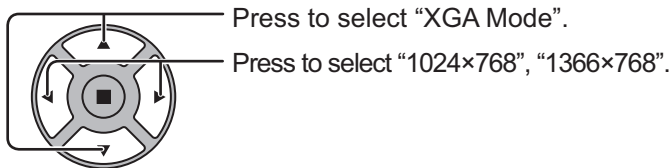

Note:

After making this setting, be sure to make each adjustment (such as "Auto Setup") on the "Pos. /Size" menu as necessary. (see page 24, 25)

Sync

This function operates only during input from PC IN terminal.

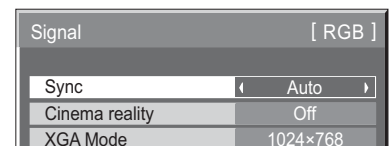
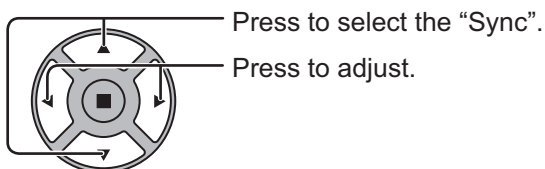

Confirm that the input is set to RGB input (this setting is valid only for RGB input signal).

Auto: The H and V sync or synchronized signal is automatically selected. If both input, it is selected the H and V sync. However, the synchronized signal that is input first is selected.



on G: Uses a synchronized signal on the Video G signal, which is input from the G connector.

HDMI Range

Switches the dynamic range according to the input signal from HDMI terminal.

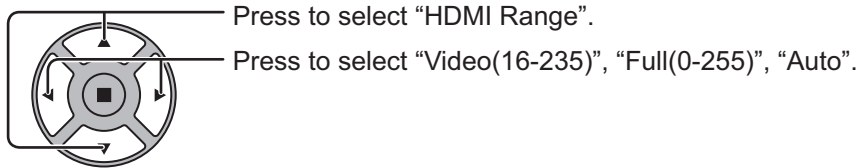

Video(16-235): If the input signal is the video range, Example: HDMI terminal output for DVD player

Full(0-255): If the input signal is full range, Example: HDMI terminal output for personal computer

Auto: Switches the dynamic range automatically between "Video(16-235)" and "Full(0-255)" according to the input signal.

Note:

This function can be set to the HDMI signal and DIGITAL LINK.

Input signal display

Displays the frequency and the type of the current input signal.

This display is valid only for PC and Digital input signal.

Display range:

Horizontal 15 - 110 kHz

Vertical 48 - 120 Hz

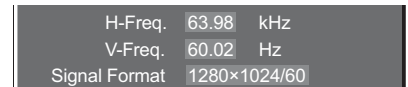

The dot clock frequency is displayed during digital signal input.

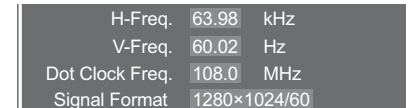

Note:

The automatically detected signal format may be displayed differently than the actual input signal.

Maintenance information

Maintenance information related to the fan and air filter is displayed.

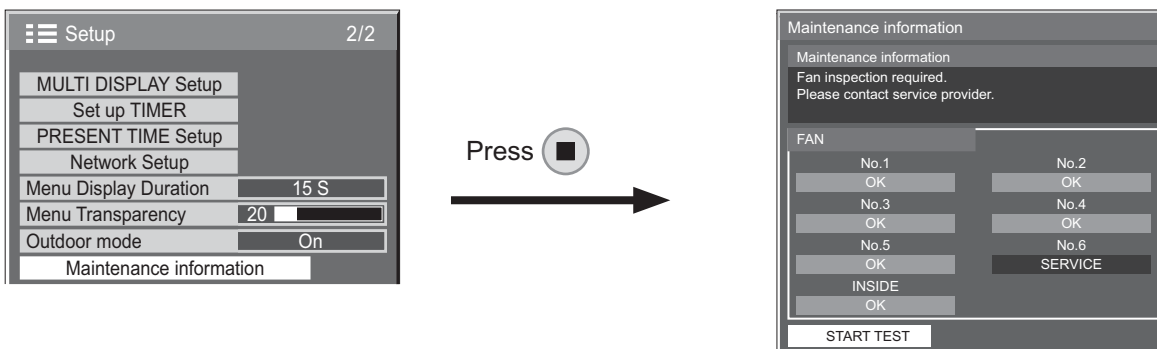

■ Maintenance information

Messages related to the air filter condition, fan operating status and inspection notifications are displayed.

When “Please clean filters. Then, click “START TEST”. Consult owner’s manual for instructions.” is displayed, remove and clean the air filter. (see page 5)

If “Please clean filters. Then, click “START TEST”. Consult owner’s manual for instructions.” is displayed again a short period after cleaning the air filter, contact the service provider.

If “Please contact service provider.” is displayed, contact the service provider.

- After cleaning the air filter, press  to execute the status test again and check the maintenance information.

■ FAN

The status of each fan is displayed.

If “SERVICE” is displayed, contact the service provider for inspection of the fan.

Note:

When viewed from the back, the fans are displayed as “No.1” to “No.6” in order starting from the right side. Interior circulation fans inside the Display are indicated as “INSIDE”.

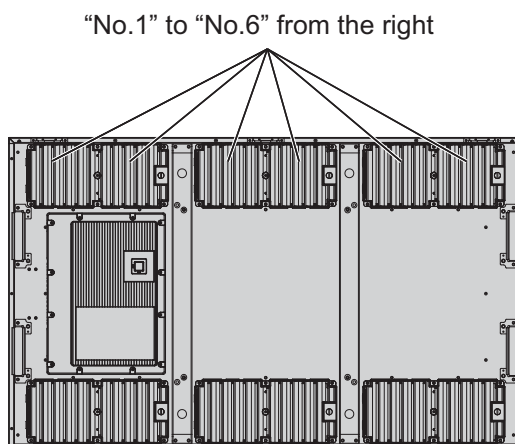

Network Setup

Configure the various settings required to use the network function.

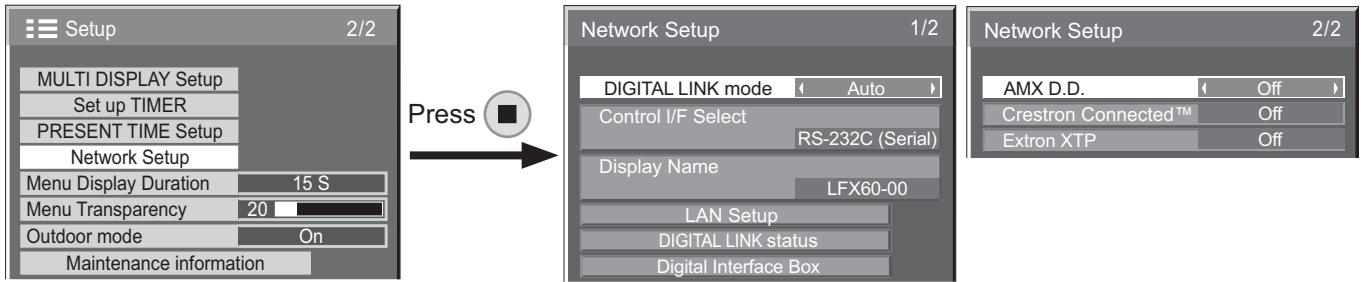

■ DIGITAL LINK mode

You can switch the communication method of DIGITAL LINK.

Auto: The communication method is automatically selected. HDMI/LAN/RS232C communication can be used. Ethernet connection can be made.

DIGITAL LINK: HDMI/LAN/RS232C communication can be used via a twisted pair cable transmitter.

Ethernet: LAN communication can be used via the LAN terminal of the Display.

Note:

When "Ethernet" is selected, set the "Control I/F Select" to "LAN".

■ Control I/F Select

RS-232C (Serial): Control using the Display's RS232C.

LAN: Control using the Display or the LAN terminal of a twisted pair cable transmitter.

RS-232C(DIGITAL LINK): Control using the twisted pair cable transmitter's RS232C.

Notes:

- When "LAN" or "RS-232C(DIGITAL LINK)" is set, the power lamp lights orange when the remote control power is switched "Off" (standby).
- When controlling using the RS232C command from page 14 to the RS232C terminal of the Display, select "RS-232C(DIGITAL LINK)" to control from the RS232C terminal of the "RS-232C (Serial)" or DIGITAL LINK device.
- When using any of the control techniques listed on pages 52 to 57, select "LAN".

■ Display Name

The name of the Display that is shown on the network can be changed.

■ LAN Setup

See page 44

■ DIGITAL LINK status

See page 45

■ Digital Interface Box

See page 45

■ AMX D.D.

This function allows the Display to be detected by AMX Device Discovery. For more details, visit the following website.

<http://www.amx.com/>

■ Crestron Connected™

When this function is set to on, the Display can be monitored or controlled via the network using equipment and application software of Crestron Electronics, Inc.

This Display supports the following application software from Crestron Electronics, Inc.

- RoomView® Express
- Fusion RV®
- RoomView® Server Edition

[Crestron Connected™] is a function to connect to a system developed by Crestron Electronics, Inc. which manages and controls multiple system devices connected to the network.

- For details of "Crestron Connected™", refer to the Crestron Electronics, Inc. website (Provided only in English).
<http://www.crestron.com/>
For the download of "RoomView® Express", refer to the Crestron Electronics, Inc. website (Provided only in English).
<http://www.crestron.com/getroomview>

■ Extron XTP

To carry out connection settings with XTP Transmitter made by Extron. Visit the following website for details.
<http://www.extron.com>

Network Setup

LAN Setup

Detailed network settings for the LAN established via the LAN terminal of the Display or twisted pair cable transmitter can be configured.

Select "LAN Setup" and press .

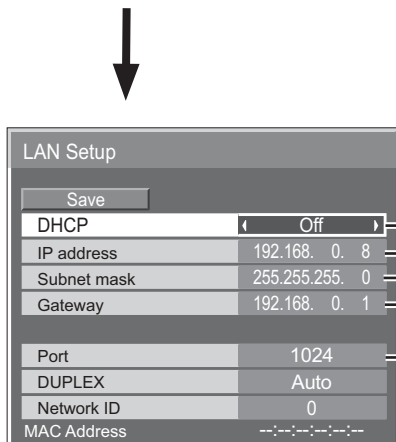

DHCP, IP address, Subnet mask, and Gateway settings



1 Set DHCP.
When "Off" is selected, IP address and other settings can be set manually.

2 Select the item and press .

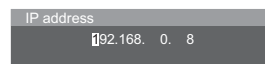
3 Enter an address.



① Use   to select a digit.

② Use   to change a number.

③ Press .

Pressing  will cancel the address change.



4 Select "Save" and press .

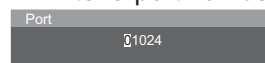

Port setting

1 Select "Port" and press .

2 Enter a port number.



① Use   to select a digit.

② Use   to change a number.

③ Press .

Pressing  will cancel the port number change.

Save

Save the current network Setup. Each value set for DHCP, IP address, Subnet mask, and Gateway will be saved. If "NG" is displayed, check the same IP address is not used within the same network.

DHCP (DHCP client function)

To obtain an IP address automatically using a DHCP server, set this to "On". If DHCP server is not used, set this to "Off".

IP address (IP address display and setting)

Enter an IP address if DHCP server is not used.

Subnet mask (Subnet mask display and setting)

Enter a subnet mask if DHCP server is not used.

Gateway (Gateway address display and setting)

Enter a gateway address if DHCP server is not used.

Port

Set the port number used for command control.

The available setting range is 1024 – 65535.

When the PLink™ protocol is used, the port setting is not necessary.

DUPLEX

Set the connection speed of the LAN environment.

Select the value from Auto, 100 Half or 100 Full.

Network ID

Set the ID to identify this unit.

The available setting range is 0 – 99.

MAC Address

Display the MAC address of this unit. However, the MAC address is not displayed when the "Control I/F Select" is set to "RS-232C (Serial)" or "RS-232C (DIGITAL LINK)".

Notes:

- To use a DHCP server, make sure the DHCP server is started.
- Contact your network administrator for details on settings.

■ DIGITAL LINK status

Display the DIGITAL LINK connection environment.

Select "DIGITAL LINK status" and press .

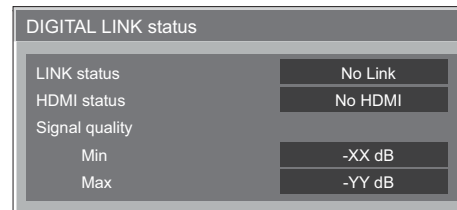

LINK status : Either "No link", "DIGITAL LINK", or "Ethernet" will be displayed.

No link : No LAN connection, etc.

DIGITAL LINK : Connected to the DIGITAL LINK device by LAN

Ethernet : The PC is connected to the DIGITAL LINK terminal of this product and is LAN connected

HDMI status : Either "No HDMI", "HDMI ON", or "HDCP ON" will be displayed.

No HDMI : DIGITAL LINK not connected

HDMI ON : DIGITAL LINK connected

HDCP ON : A signal with an HDCP is flowing with a DIGITAL LINK connection.

Signal quality : It is the quantified minimum and maximum numbers of errors that have occurred. The display colors are red, yellow, or green, depending on the number.

The number is represented by yellow or red if the LAN cable is disconnected or the cable is not shielded. This signal quality shows figures between the twisted pair cable transmitter that is connected and the display.

| Signal Quality | Display Colors | Reception Status |
|----------------|----------------|--|
| -12dB or below | Green | The reception is normal |
| -11 to -8dB | Yellow | Part of the received data is corrupted |
| -7dB or above | Red | There are reception difficulties |

■ Digital Interface Box

A switch will be made to the Set up Digital Interface Box menu when "Digital Interface Box" is selected and  is pressed.

Note:

This function can only be selected when the Digital Interface Box (ET-YFB100) made by our company is connected to a LAN terminal and its power is on.

Options Adjustments

1  Press to display the Setup menu.

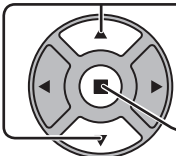
2  Press to select "OSD Language".
Press for more than 3 seconds.

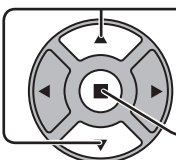
3  Press to select "Options".
Press to display the Options menu.

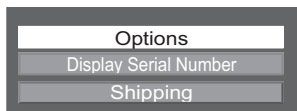

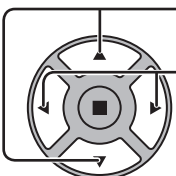



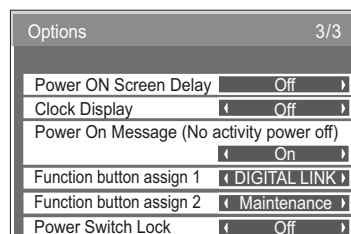
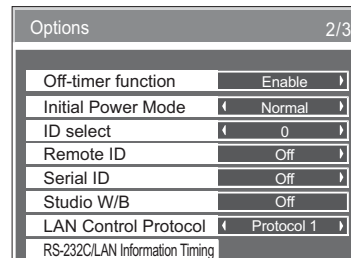
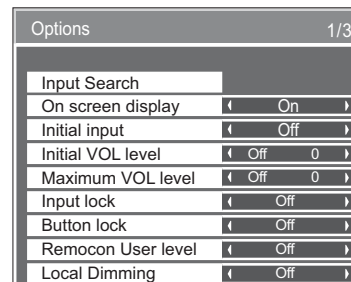

























4  Press to select your preferred menu.
Press to adjust the menu.

5  Press to exit from Options menu.



• The serial number of this device is displayed when "Display Serial Number" is selected in step 3.

| Item | Adjustments |
|--------------------------|---|
| Input Search | Set auto input switching for when there is no signal. (see page 48) |
| On screen display | <p>On: Displays all the following on screen.</p> <ul style="list-style-type: none"> • Power on display • Input signal switch display • No signal display • Mute and the remaining time of off-timer after  was pressed. <p>Off: Hides all the items above from view.</p> |
| Initial input | <p>Adjusts the input signal when the unit is turned on.</p> <p>Off ↔ PC ↔ DVI ↔ HDMI ↔ DIGITAL LINK ↔ Off</p> <p>Notes:</p> <ul style="list-style-type: none"> • Only the adjusted signal is displayed. (see page 18) • This menu is available only when "Input lock" is "Off". |
| Initial VOL level | <p>Press   button to adjust the volume when the unit is turned on.</p> <p>Off ↔ On</p> <p>Off: Sets normal volume.</p> <p>On: Sets your preferred volume.</p> <p>Notes:</p> <ul style="list-style-type: none"> • When "Maximum VOL level" is "On", the volume can only be adjusted between 0 and your maximum range. • You can hear the changed volume regardless of your volume setting before opening the options menu if you adjust the volume when "Initial VOL level" is "On" and cursor is on the menu. |
| Maximum VOL level | <p>Press   button to adjust the maximum volume.</p> <p>Off ↔ On</p> <p>Off: Sets auto maximum volume.</p> <p>On: Sets your preferred maximum volume.</p> <p>Notes:</p> <ul style="list-style-type: none"> • If the "Maximum VOL level" is set lower than the "Initial VOL level", the "Initial VOL level" automatically becomes the same as the "Maximum VOL level". • The volume display can go up to 100 regardless of the settings. • You can hear the changed volume regardless of your volume setting before opening the options menu if you adjust the volume when "Maximum VOL level" is "On" and cursor is on the menu. |
| Input lock | <p>Locks the input switch operation.</p> <p>Off ↔ PC ↔ DVI ↔ HDMI ↔ DIGITAL LINK ↔ Off</p> <p>Notes:</p> <ul style="list-style-type: none"> • Only the adjusted signal is displayed (see page 18). • Input switch can be used when this is set to "Off". |

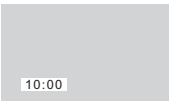
| Item | Adjustments |
|---------------------------------------|---|
| Button lock | <p>Off ↔ On ↔ MENU&ENTER</p> <p>Off: All the buttons on main unit can be used.</p> <p>MENU&ENTER: Locks  MENU and  ENTER buttons on main unit.</p> <p>On: Locks all the button on main unit except the Power switch.</p> <p>Sets Button lock with the unit buttons in the following procedure.</p> <p>Off: Press  + / ▲ four times → Press  INPUT four times → Press  - / ▼ four times → Press  ENTER/</p> <p>MENU&ENTER: Press  ENTER/ four times → Press  + / ▲ four times → Press  INPUT four times → Press  ENTER/</p> <p>On: Press  - / ▼ four times → Press  ENTER/ four times → Press  + / ▲ four times → Press  ENTER/</p> |
| Remocon User level | <p>Off ↔ User1 ↔ User2 ↔ User3</p> <p>Off: You can use all of the buttons on the remote control.</p> <p>User1: You can only use  POWER,  INPUT,  RECALL,  MUTE,  SKIP,  STOP,  PAUSE buttons on the remote control.</p> <p>User2: You can only use  POWER button on the remote control.</p> <p>User3: Locks all the buttons on remote control.</p> |
| Local Dimming | <p>Improve the contrast by controlling the amount of LED backlight.</p> <p>The contrast ratio of different area in a same picture can be dramatically improved.</p> <p>Off: Disables Local Dimming function.</p> <p>On: Enables Local Dimming function.</p> |
| Off-timer function | <p>Enable: Enables the “Off-timer function”.</p> <p>Disable: Disables the “Off-timer function”.</p> <p>Note: When “Disable” is set, the Off-timer is cancelled.</p> |
| Initial Power Mode | <p>Normal ↔ On ↔ Standby</p> <p>Sets the power mode of the unit for when the power recovers from failure or after plugging off and in again.</p> <p>Normal: Power returns in as the same state as before the power interruption.</p> <p>Standby: Power returns in standby mode. (Power Indicator : red/orange)</p> <p>On: Power returns in power On. (Power Indicator : green)</p> <p>Note: When using multiple displays, “Standby” is preferred to be set in order to reduce a power load.</p> |
| ID select | <p>Sets panel ID number when panel is used in “Remote ID” or “Serial ID”.</p> <p>Set value range: 0 - 100</p> <p>(Standard value: 0)</p> |
| Remote ID | <p>The setting of this menu is valid only when using ID remote control.</p> <p>Off: Disables ID remote control functions. You can use normal remote control operations.</p> <p>On: Enable ID remote control functions.</p> <p>Note: To use the ID remote control function, it is necessary to set each ID number of remote control and display unit. About the setting method, please refer to “ID Remote Control Function” (see page 38) and “ID select” (above-mentioned).</p> |
| Serial ID | <p>Sets the panel ID Control.</p> <p>Off: Disables external control by the ID.</p> <p>On: Enables the external control by the ID.</p> |
| Studio W/B | <p>Off: Nullify all the settings adjusted.</p> <p>On: Sets the colour temperature for TV studio.</p> <p>Note: Valid only when the “Warm” is set as “White balance” in Picture menu.</p> |
| LAN Control Protocol | <p>Select the LAN control protocol.</p> <p>Protocol 1: Control with the Panasonic Display sequence.</p> <p>Protocol 2: Control with the sequence that compatible with Panasonic Projector.</p> |
| RS-232C/LAN Information Timing | <p>Set up the informing manner if error warning occurred. (see page 49)</p> |
| Power ON Screen Delay | <p>Off ↔ 1 ↔ 2 ↔ 3... ↔ 30</p> <p>You can set the power-on delay time of the displays to reduce the power load, when you press  / to turn on the multiple displays that are set together, for example, on MULTI DISPLAY system.</p> <p>Set each display’s setting individually.</p> <p>Off: The display will be turned on at the same time as  / is pressed.</p> <p>1 to 30 (sec.): Set the power-on delay time (second).</p> <p style="padding-left: 40px;">After pressing  / , the display will be powered on with time delay depending on this setting.</p> <p>Notes:</p> <ul style="list-style-type: none"> • During this function is working, the power indicator is blinking green. • This function also works when the power recovers from failure or after plugging off and in again the power cord. |
| Clock Display | <p>Off: Not display the clock.</p> <p>On: Display the clock.</p> <p>The clock is displayed at the lower left of the screen when  button is pressed.</p> <div style="text-align: center;">  </div> <p>Note: When “PRESENT TIME Setup” is not set, the clock is not displayed even if “Clock Display” is “On”. (see page 29)</p> |

Options Adjustments

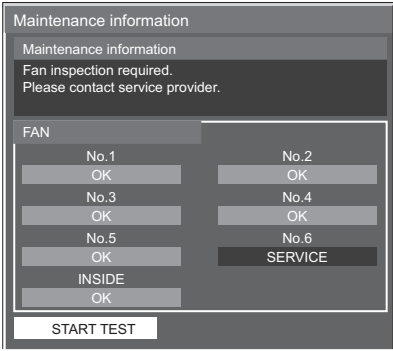
| Item | Adjustments |
|--|---|
| Power On Message (No activity power off) | Whether to show/hide No activity power off Precautions at the time of power ON is set. On: The warning precautions are shown at the time of power ON. Off: The warning precautions are not shown at the time of power ON. Note: This setting is enabled only if “No activity power off” is “Enable” (see page 33). |
| Function button assign 1 Function button assign 2 | Set the functions that operates when ^{FUNCTION} [1] [2] is pressed. Signal: The “Signal” menu is displayed. Screensaver: The “Screensaver” menu is displayed. ECO menu: The “ECO Mode settings” menu is displayed. Set up TIMER: The “Set up TIMER” menu is displayed. DIGITAL LINK: Switch to DIGITAL LINK inputs. If it is ET-YFB100, the input switch menu on the YFB100 side is displayed. Maintenance: Display the maintenance information. Note: Factory settings are as follows. FUNCTION1 button: DIGITAL LINK FUNCTION2 button: Maintenance Use the FUNCTION button The menu screen is displayed. (Example: Maintenance)  Press the FUNCTION button to exit from the menu. |
| Power Switch Lock | Sets the lock setting for the display Power switch. On: Power switch operation is disabled. Off: Power switch operation is enabled. Note: This function is only for TH-47LFX60U and TH-47LFX6NU. |

Normalisation

When both main unit buttons and remote control are disabled due to the “Button lock”, “Remocon User level” or “Remote ID” adjustments, set all the values “Off” so that all the buttons are enabled again.

Press the - / ▾ button on main unit together with button on the remote control and hold for more than 5 seconds. The “Shipping” menu is displayed and the lock is released when it disappears.

Input Search

When a signal is not detected, another input with a signal is automatically selected.

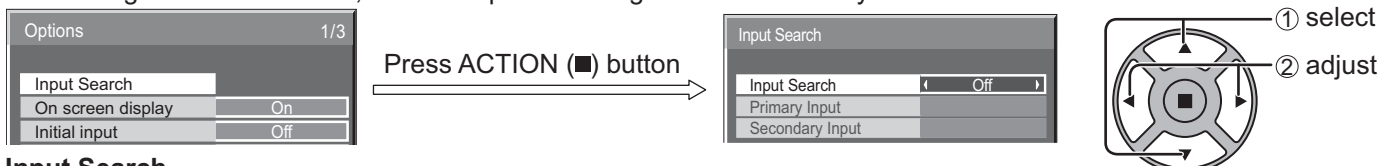

Input Search

Off: When there is no signal, the input is not switched automatically.

All Inputs: Searches all inputs and switches to an input with a signal.

Priority: Searches “Primary Input” and “Secondary Input” in order and switches to an input with a signal.

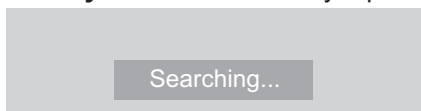

“Searching...” is displayed during the input search.

Primary Input, Secondary Input

Set the input to search when “Priority” is selected.

(NONE) ↔ PC ↔ DVI ↔ HDMI ↔ DIGITAL LINK

Note: This menu is available only when “Input lock” is “Off”. (see page 46)

RS-232C/LAN Information Timing

Set up the informing manner for no signal or temperature rising.

While RS232C controls: Warning or error message sent on the display automatically.

While LAN controls: Acquire the warning or error message from the display.

| Options 2/3 | |
|--------------------------------|------------|
| Off-timer function | Enable |
| Initial Power Mode | Normal |
| ID select | 0 |
| Remote ID | Off |
| Serial ID | Off |
| Studio W/B | Off |
| LAN Control Protocol | Protocol 1 |
| RS-232C/LAN Information Timing | |

Press ACTION (■) button



| RS-232C/LAN Information Timing | |
|-----------------------------------|-------|
| No Signal Warning | On |
| No Signal Warning Timing | 5min |
| No Signal Error | On |
| No Signal Error Timing | 10min |
| Temperature Warning | On |
| Temperature Warning Value | 55°C |
| Temperature Warning Release Value | 52°C |

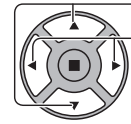

- ① select
- ② adjust

■ No Signal Warning

If set to "On", the display sends out the no signal warning.

■ No Signal Warning Timing

Set up the detecting time for no signal warning.

■ No Signal Error

If set to "On", the display sends out the no signal error.

■ No Signal Error Timing

Set up the detecting time for no signal error.

The warning of "No Signal Warning" and the error of "No Signal Error" are not sent when the no signal state is detected through any of the following functions:

No Signal power off: Enable, PC Power management, DVI-D Power management (see page 34)

Setting Example

No Signal Warning Timing: 5 minutes

No Signal Error Timing: 10 minutes

PC Power management: On (30 seconds)

If there is no signal when PC IN is input, "PC Power management" is activated first and the Display enters the standby mode.

Note:

The "No Signal Error Timing" cannot be set shorter than "No Signal Warning Timing".

■ Temperature Warning

If set to "On", the display sends out the warning temperature.

■ Temperature Warning Value

Set up the detecting temperature for temperature warning.

■ Temperature Warning Release Value

Set up the temperature to release the temperature warning.

Using Network Function

Network Connection

This unit has a network function to control the network connected display with your computer.

Note:

To use the network function, set each “Network Setup” setting and make sure to set the “Control I/F Select” to “LAN”. (see page 43)

When “LAN” is set, power indicator lights orange under the condition of power “Off” with remote control (stand-by state).

Example of network connection

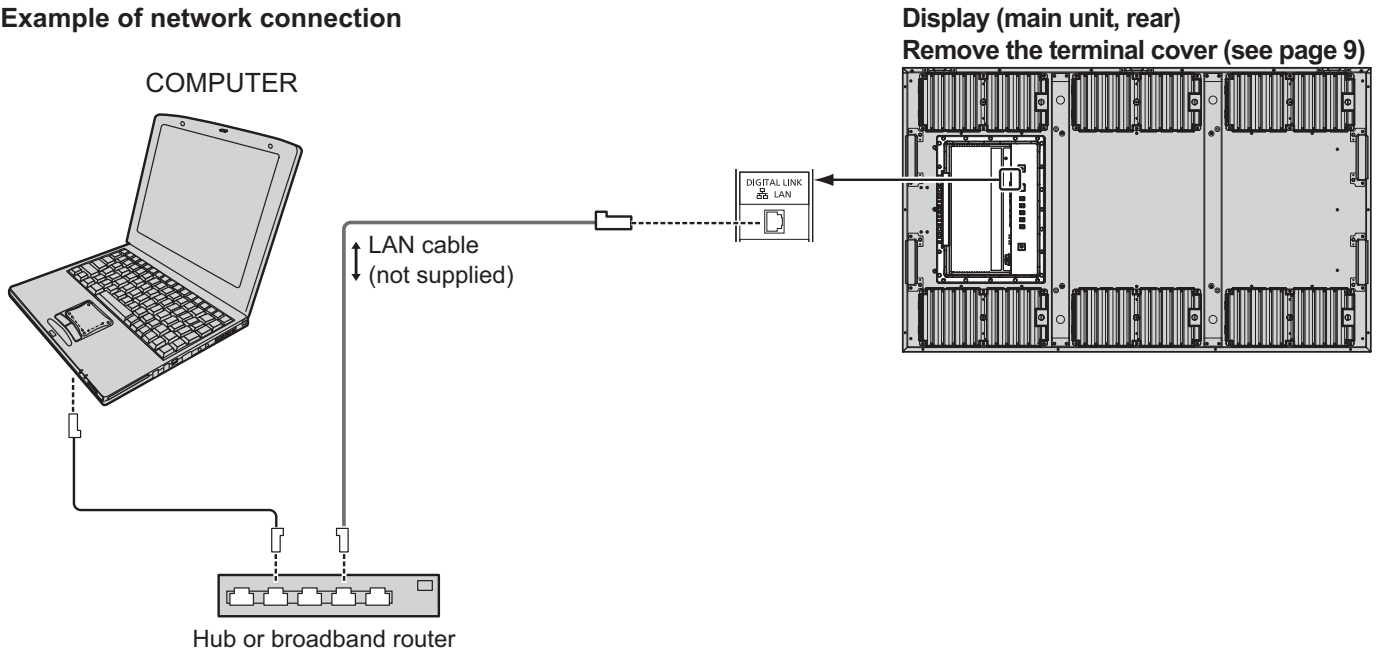

Notes:

- Make sure the broadband router or hub supports 100BASE-TX.
- Use a LAN cable between the twisted pair cable transmitter and the device that conforms to the following conditions.
 - It meets or exceeds CAT5e standards
 - It is a straight cable
 - It is a shielded cable (with a connector)
 - It is a solid cable
- When laying the cable(s), use an instrument such as a cable tester or cable analyzer and check whether the cable characteristics are CAT5e or above. When using a relay connector along the path, also include this in the measurements.
- Touching the DIGITAL LINK terminal with a statically charged hand (body) may cause damage due to its discharge.
Do not touch the DIGITAL LINK terminal or a metal part of the LAN cable.
- For instructions on how to connect, consult your network administrator.

DIGITAL LINK Connections (connecting with a twisted pair cable transmitter)

This device is equipped with functions that allow Ethernet signals from a twisted pair cable transmitter to be received through a LAN cable along with video/audio signals.

Network connections via twisted pair cable transmitter

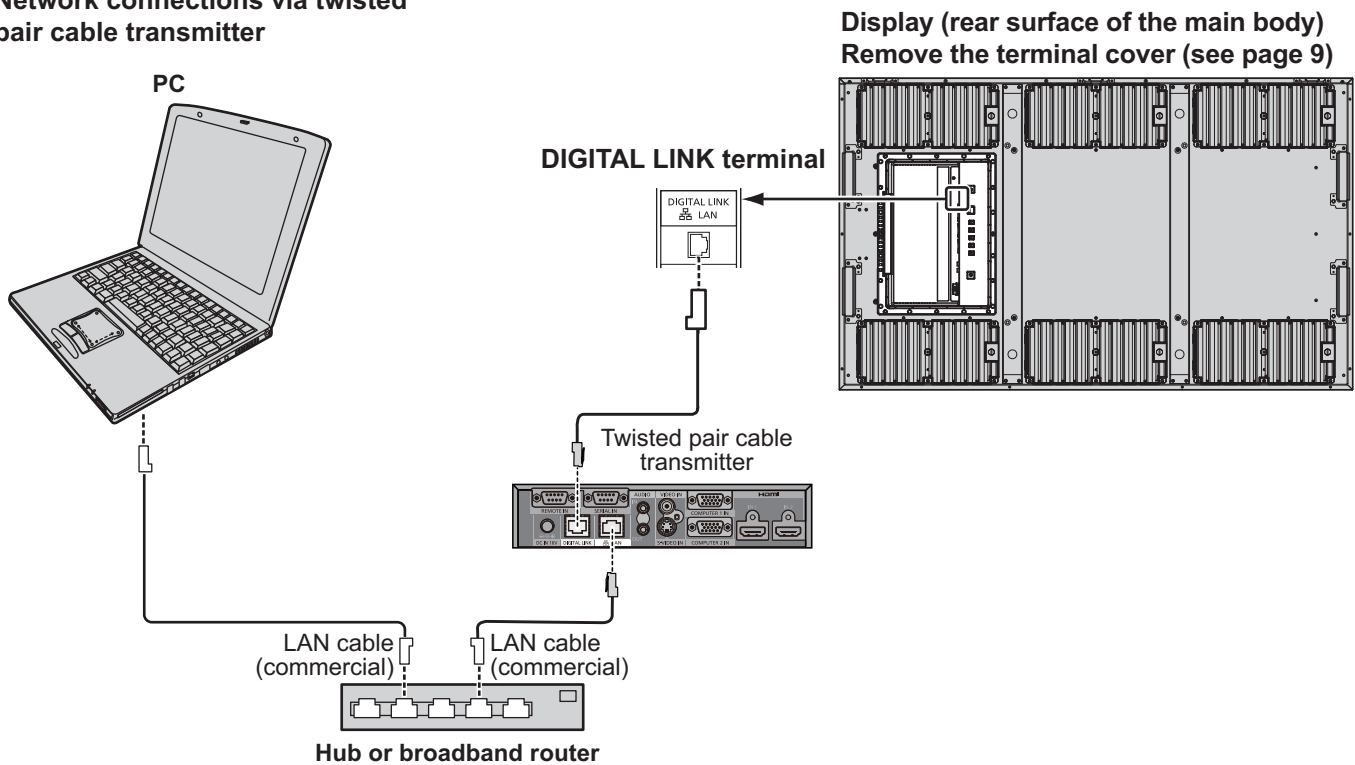

Note:

Configure the settings in "Network Setup" when using a DIGITAL LINK connection. (see pages 43 to 45)

Precautions for use while connecting with a twisted pair cable transmitter

Installing / Connecting

- Ask the dealer or a qualified technician to carry out the cable wiring work for DIGITAL LINK connections. Insufficient wiring work may cause the inability to apply the cable transmission characteristics and cropped or fuzzy images and sounds.
- The transmission distance between the twisted pair cable transmitter and the device is up to 100 meters. Exceeding this distance can cause cropped images or sounds, as well as LAN communication errors.
- Do not use a hub between the twisted pair cable transmitter and the Display.
- When connecting to the Display using the twisted pair cable transmitter (receiver) of other maker, do not use another twisted pair cable transmitter between the twisted pair cable transmitter of other maker and this device. The images and sounds may be interrupted or become unstable.
- If possible, lay the cable so that it is extended and not coiled in order to minimize both external and internal noise.
- Lay out cables of the twist pair cable transmitter and this product away from other cables, especially from the power supply cable.
- When laying multiple cables, keep them as close together as possible running parallelly and not bundled.
- After laying the cable(s), make sure that the signal quality in "DIGITAL LINK status" is -12 dB or below.

Twisted pair cables

- Use a LAN cable between the twisted pair cable transmitter and the device that conforms to the following conditions.
 - It meets or exceeds CAT5e standards
 - It is a straight cable
 - It is a shielded cable (with a connector)
 - It is a solid cable
- When laying the cable(s), use an instrument such as a cable tester or cable analyzer and check whether the cable characteristics are CAT5e or above. When using a relay connector along the path, also include this in the measurements.
- Do not pull cables hard. Also avoid forcefully bending or folding them.

Other

- This device is compatible with our Digital Interface Box (ET-YFB100). For the twisted pair cable transmitter of the other maker, refer to the following URL. (<http://panasonic.net/prodisplays/products/471fx60/index.html>)

Using Web Browser Control

You can use a Web browser to control the unit and set up a network and password.

Before Using Web Browser Control

To use the Web browser control, the unit and computer setups are required.

Unit Setup

Set each “Network Setup” setting and make sure to set the “Control I/F Select” to “LAN”. (see page 43)

Computer Setup

Disable the proxy server settings and enable JavaScript.

(Windows)

Disable proxy server settings

- 1 Display [Internet Properties] window.
Click [Start] – [Control Panel] – [Network and Internet] – [Internet Options].
- 2 Click the [Connections] tab and then [LAN Settings].
- 3 Deselect the [Use automatic configuration script] and [Use a proxy server for your LAN] boxes.
- 4 Click [OK].

Enable JavaScript

- 1 Display [Internet Properties] window.
Click [Start] – [Control Panel] – [Network and Internet] – [Internet Options].
- 2 Set the security level on the [Security] tab to [Default Level]. Alternatively enable [Active scripting] from the [Custom Level] button.

(Macintosh)

Disable proxy server settings

- 1 From the [Safari] menu, click [Preferences].
General screen is displayed.
- 2 From the [Advanced] tab, click the [Change Settings...] button next to [Proxies]. Click [Proxies] and set up a proxy server.
- 3 Deselect the [Web Proxy] and [Automatic Proxy Configuration] boxes.
- 4 Click [Apply Now].

Enable JavaScript

- 1 Display [Security] of Safari.
- 2 Select [Enable JavaScript] under [Web content].

Access from Web Browser

Access to the TOP screen of the Web browser control using a Web browser.

- 1 Start your Web browser.
- 2 Enter the IP address set with the “LAN Setup” of the unit.
(see page 44)

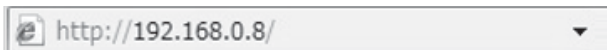

- 3 Enter the user name and password when the Authentication screen is displayed.

Authentication screen

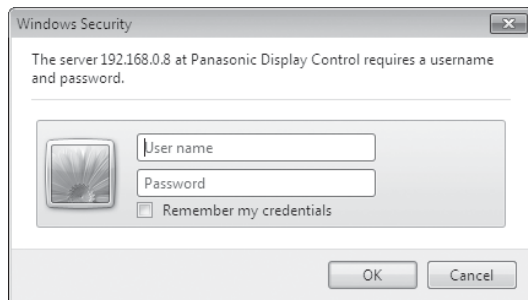

- 4 Click [OK].
After logged in, the TOP screen of the Web browser control is displayed. (see page 54)

Notes:

- The password used here is the same password used for command control and the PJLink™ security authentication.
- Default user name and password are as follows:
User name: user1
Password: panasonic
- The password can be changed on the Password Setup screen after logging in (see page 55). The user name cannot be changed.
- Under no circumstances, Panasonic Corporation or it's associated companies will ask customers their password directly.
Even if you are asked directly, please do not reveal your password.

Using Web Browser Control

TOP screen structure of the Web browser control

After logging in, the TOP screen of the Web browser control is displayed.

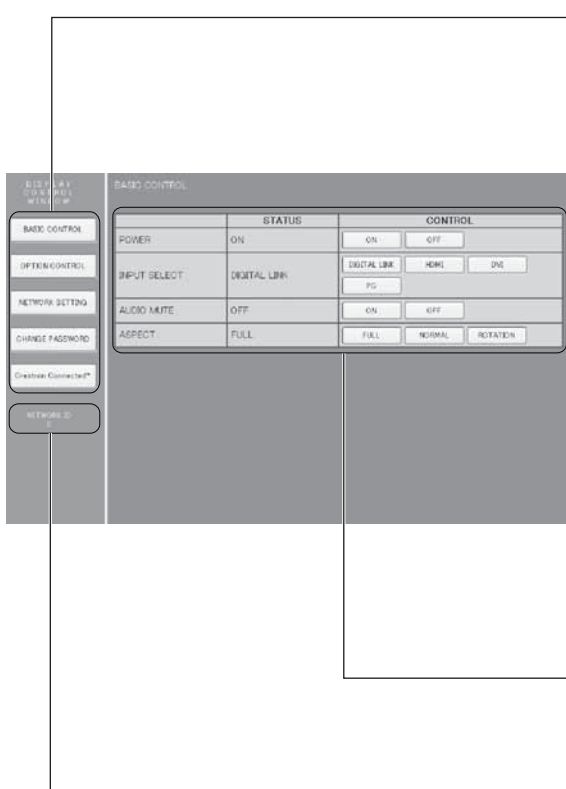

① Menu

Menu items are displayed. When a button is clicked, setup screen of each item is displayed.

| Item | Details |
|---------------------|---|
| BASIC CONTROL | BASIC CONTROL screen is displayed. (see below) |
| OPTION CONTROL | OPTION CONTROL screen is displayed. (see below) |
| NETWORK SETTING | Network Setup screen is displayed. (see page 55) |
| CHANGE PASSWORD | Password setup screen is displayed. (see page 55) |
| Crestron Connected™ | The Crestron Connected™ operations screen will appear. (see pages 56, 57) <ul style="list-style-type: none"> This button does not appear when “Crestron Connected™” in “Network Setup” is “OFF”. (see page 43) |

② According to the selected item from the menu, setup status or set items are displayed.

③ Network ID information

ID to identify the unit is displayed.

Display Control (BASIC CONTROL/OPTION CONTROL Screen)

Click BASIC CONTROL or OPTION CONTROL from the menu. Various controls of the unit can be set.

BASIC CONTROL screen

Click BASIC CONTROL from the menu. Unit status and buttons to change settings are displayed.

| | STATUS | CONTROL |
|--------------|--------------|---|
| POWER | ON | <input type="button" value="ON"/> <input type="button" value="OFF"/> |
| INPUT SELECT | DIGITAL LINK | <input type="button" value="DIGITAL LINK"/> <input type="button" value="HDMI"/> <input type="button" value="DVI"/> <input type="button" value="PG"/> |
| AUDIO MUTE | OFF | <input type="button" value="ON"/> <input type="button" value="OFF"/> |
| ASPECT | FULL | <input type="button" value="FULL"/> <input type="button" value="NORMAL"/> <input type="button" value="ROTATION"/> |

| Item | Details |
|--------------|--|
| POWER | Switch ON/OFF of the unit power. |
| INPUT SELECT | Switch the input signals. Displayed buttons vary according to the connection status of the video device. |
| AUDIO MUTE | Switch ON/OFF of the sound mute. |
| ASPECT | Switch the screen modes |

OPTION CONTROL screen

Click OPTION CONTROL from the menu. Command input field for command control of the unit is displayed.

| | |
|-------------------------------------|----------------------|
| COMMAND | <input type="text"/> |
| RESPONSE | <input type="text"/> |
| <input type="button" value="SEND"/> | |

| Item | Details |
|----------|--|
| COMMAND | Enter a command. Use the same command used for the serial control. (see page 14) |
| RESPONSE | Response from the unit is displayed. |
| SEND | Command is sent and run. |

Note:

After the settings are changed, it may take a while till the display's response is displayed.

NETWORK SETTING (NETWORK SETTING Screen)

Click NETWORK SETTING from the menu. Various settings of a network can be set. For the details of the setting items, please check Network Setup under the Set up of the unit. (see page 44)

| | |
|-------------------------------------|---|
| DHCP | <input type="radio"/> OFF <input checked="" type="radio"/> ON |
| IP ADDRESS | 192.168.0.8 |
| SUBNET MASK | 255.255.255.0 |
| GATEWAY | 192.168.0.1 |
| PORT | 1024 |
| LAN SPEED | <input checked="" type="radio"/> AUTO <input type="radio"/> 100 FULL <input type="radio"/> 100 HALF |
| NETWORK ID | 0 |
| <input type="button" value="SAVE"/> | |

Notes:

- To use a DHCP server, make sure the DHCP server is started.
- During a DHCP server is used, IP ADDRESS, SUBNET MASK, and GATEWAY values cannot be entered.
- When the set values are changed properly, "NETWORK SETTING CHANGED." message and the changed set items are displayed.

| Item | Details |
|-------------|--|
| DHCP | Set to ON when a DHCP server is used, or OFF when it is not used. |
| IP ADDRESS | Enter an IP address. |
| SUBNET MASK | Enter a subnet mask. |
| GATEWAY | Enter a gateway address. |
| PORT | Enter the port number used for command control. The available setting range is 1024 - 65535. |
| LAN SPEED | Set the connection speed of the LAN environment. |
| NETWORK ID | Set the ID to identify this unit. The available setting range is 0 - 99. |
| SAVE | Save the each set value. |

Password Setting (CHANGE PASSWORD Screen)

Click CHANGE PASSWORD from the menu. Password to access the Web browser control can be set. When the password is changed in this screen, the password used for command control and the PJLink™ security authentication is also changed.

| | |
|-------------------------------------|-------|
| OLD PASSWORD | |
| NEW PASSWORD | |
| NEW PASSWORD (RETYPE) | |
| <input type="button" value="SAVE"/> | |

Notes:

- The default password is "panasonic".
- Up to 32 alphanumeric characters can be used for a password.
- When the password is changed properly, "Password has changed." message is displayed.

| Item | Details |
|-----------------------|---|
| OLD PASSWORD | Enter the old password. |
| NEW PASSWORD | Enter the new password. |
| NEW PASSWORD (RETYPE) | Enter the password entered in "NEW PASSWORD" for confirmation. |
| SAVE | Save the new password. The confirmation screen is displayed. Click OK to change the password. |

Crestron Connected™ page

You can monitor or control the Display using Crestron Connected™.

When you click [Crestron Connected™], the Crestron Connected™ operation page is displayed.

If Adobe Flash Player is not installed in your computer, or if the browser does not support Flash, this page does not appear. In this case, return to the previous page by clicking [Back] in the operation page.

Operation page

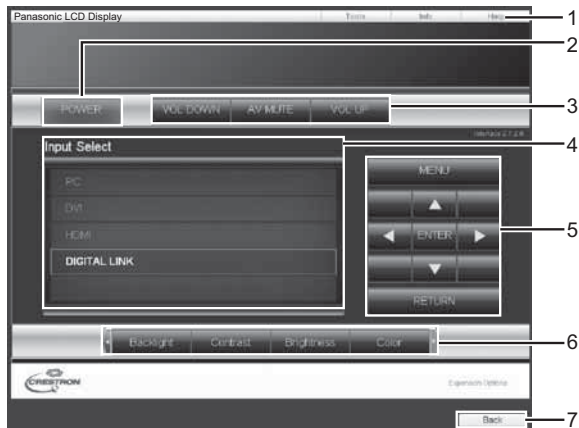

1 Tools, Info, Help

Switches the pages for tools, information, help using the tab.

2 POWER

Switches between on and off of the power.

3 VOL DOWN, AV MUTE, VOL UP

Sets the volume, AV mute. When the power of the Display is turned off, VOL DOWN, AV MUTE and VOL UP are not available.

4 Input Select

Sets the input selection. When the power of the Display is turned off, this operation is not available.

5 Operation buttons on the menu screen

Operates on the menu screen.

6 Image quality adjustments

Operate items related to image quality.

7 Back

Returns to the previous page.

Tools page

Click Tools on the operation page.

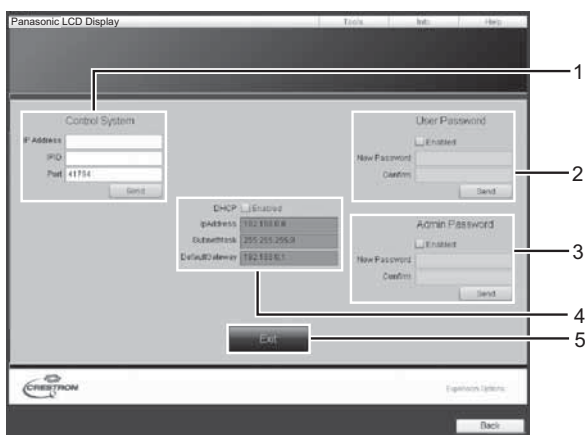

1 Control system

Sets the information required for the communication with the controller that is connected to the Display.

2 User Password

Sets the password for the user rights in the operation page of Crestron Connected™.

3 Admin Password

Sets the password for the administrator rights in the operation page of Crestron Connected™.

4 Network status

Displays the setting of LAN.

DHCP: Displays the value in the current setting.

IpAddress: Displays the value in the current setting.

SubnetMask: Displays the value in the current setting.

DefaultGateway: Displays the value in the current setting.

5 Exit

Return to the operation page.

Note:

When you monitor or control the Display using Crestron Connected™, set “Crestron Connected™” to “On” in the “Network Setup” menu. (see page 43)

Info page

Click Info on the operation page.

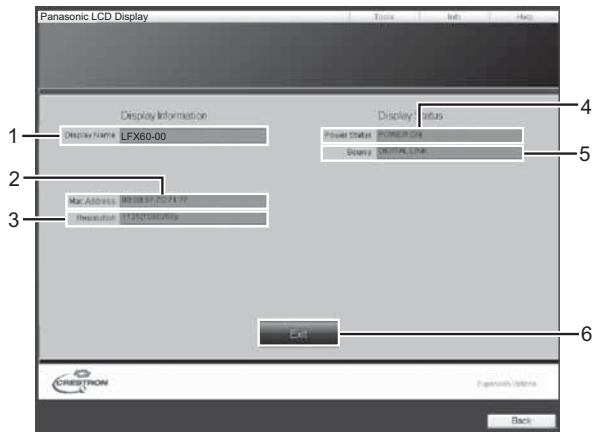

1 Display Name

Displays the name of the Display.

2 Mac Address

Displays the MAC address.

3 Resolution

Displays the resolution of the Display.

4 Power Status

Displays the status of the power.

5 Source

Displays the selected video input.

6 Exit

Return the operation page.

Help page

Click Help on the operation page.

The Help Desk screen is displayed.

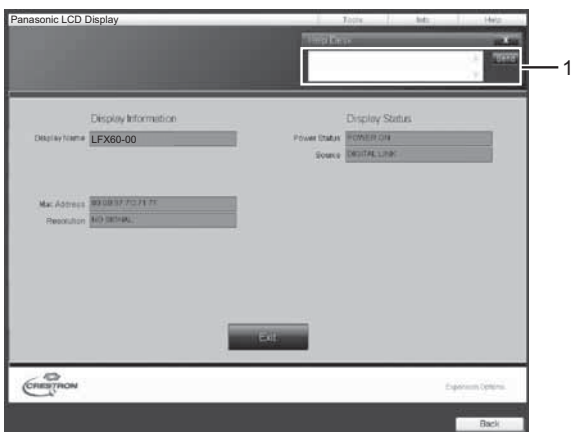











1 Help Desk

Sends or receive messages to the administrator who uses Crestron Connected™.

Troubleshooting

Before you call for service, determine the symptoms and make a few simple checks as shown below.

| Symptoms | | Checks |
|---|--|---|
| Picture | Sound | |
|  Interference |  Noisy Sound | Electrical Appliances Cars / Motorcycles Fluorescent light |
|  Normal Picture |  No Sound | Volume (Check whether the mute function has been activated on the remote control.) |
|  No Picture |  No Sound | Not plugged into AC outlet Not switched on Picture and Brightness/Volume setting (Check by pressing the power switch or stand-by button on the remote control.) |
|  No Picture |  Normal Sound | If a signal with a non-applicable colour system format, or frequency is input, only the input terminal indication is displayed. |
|  No Colour |  Normal Sound | Colour controls set at minimum level (see page 26, 27) |
| No remote control operations can be performed. | | Check whether the batteries have discharged completely and, if they have not, whether they were inserted properly. Check whether the remote control sensor is exposed to an outdoor light or a strong fluorescent light. Check whether the remote control designed specifically for use with the unit is being used. (The unit cannot be operated by any other remote control.) |
| A cracking sound is sometimes heard from the unit. | | If there is nothing wrong with the picture or sound, this is the sound of the cabinet undergoing very slight contractions in response to changes in the room temperature. There are no adverse effects on the performance or other aspects. |
| The top or bottom of the picture on the screen is cut off when I use the zoom function. | | Adjust the position of the picture on the screen. |
| Areas at the top and bottom of the screen where the image is missing appear when I use the zoom function. | | When using a video software program (such as a cinema size program) with a screen wider than one in the 16:9 mode, blank areas separate from the images are formed at the top and bottom of the screen. |
| I can hear sounds coming from inside the unit. | | When the power is turned on, a sound of the fan may be heard: This is normal and not indicative of malfunctioning. |
| Parts of the unit become hot. | | Even when the temperature of parts of the front, top and rear panels has risen, these temperature rises will not pose any problems in terms of performance or quality. |
| Power automatically turns off unexpectedly. | | Check the settings of "No signal power off", "PC Power management", "DVI-D Power management" and "No activity power off". Any of them may be set to "On (Enable)". (see page 33, 34) |
| There is no picture displayed or sound output sometimes. | | When HDMI or DVI signals are input to the Display using a selector or distributor, sound or images may not be output in the normal fashion depending on the selector or distributor used. The symptoms may be improved by turning the power off and on again, or by replacing the selector or distributor. |
| The RS232C is uncontrollable | | Check whether the connection has been made properly. (see page 14) When controlling the RS232C command on page 14 from the RS232C terminal in the display, make sure that "Control I/F Select" is "RS-232C (Serial)", and that it is "RS-232C(DIGITAL LINK)" when controlling from the RS232C terminal of the DIGITAL LINK device. (see page 43) Check whether "LAN Setup" has been configured properly. (see page 44) (When controlling from the RS232C terminal of the DIGITAL LINK device) |
| The LAN is uncontrollable | | Check whether the connection has been made properly. (see page 50) Check whether "Control I/F Select" is "LAN" when controlling with the WEB browser control or the command control on page 52. (see page 43) Check whether "LAN Setup" has been configured properly. (see page 44) When connecting to a device of AMX, Crestron Electronics, Inc., or Extron, set "AMX D.D.", "Crestron Connected™", or "Extron XTP" according to the device to use. (see page 43) See the "Signal quality" information of "DIGITAL LINK status" to check the LAN cable status such as whether the LAN cable is disconnected or the cable is not shielded. (see page 45) |

| Symptoms | Checks |
|---|---|
| There is no picture displayed or sound output from the DIGITAL LINK terminal. | Check whether the connection has been made properly between the video (output) equipment and twisted pair cable transmitter and between the twisted pair cable transmitter and this product. (see page 15) Check whether "DIGITAL LINK mode" is set to "Auto" or "DIGITAL LINK" instead of "Ethernet". (see page 43) |
| This LCD Display uses special image processing. Hence a slight time lag may occur between image and audio, depending on the type of input signal. However, this is not a malfunction. | |

LCD Display panel

| Symptoms | Check |
|--|--|
| The screen darkens slightly when bright pictures with minimal movements are shown. | The screen will darken slightly when photos, still images of a computer or other pictures with minimal movements are shown for an extended period. This is done to reduce image retention on the screen and the shortening of the screen's service life: It is normal and not indicative of malfunctioning. |
| It takes a while for the picture to appear. | The unit digitally processes the various signals in order to reproduce esthetically pleasing images. As such, it sometimes takes a few moments for the picture to appear when the power has been turned on, when the input has been switched. |
| The edges of the images flicker. | Due to the characteristics of the system used to drive the panel, the edges may appear to flicker in the fast-moving parts of the images: This is normal and not indicative of malfunctioning. |
| There may be red spots, blue spots, green spots and black spots on the screen. | This is a characteristic of liquid crystal panels and is not a problem. The liquid crystal panel is built with very high precision technology giving you fine picture details. Occasionally, a few non-active pixels may appear on the screen as fixed points of red, blue, green, or black. Please note this does not affect the performance of your LCD. |
|  <p>Image retention appears</p> | Image retention may occur. If you display a still picture for an extended period, the image might remain on the screen. However, it will disappear after a while. This is not considered as malfunction. |

Applicable Input Signals

PC signals

*Mark: Applicable input signal

| | Signal name | Horizontal frequency (kHz) | Vertical frequency (Hz) | PC IN (Dot clock (MHz)) | DVI-D IN (Dot clock (MHz)) | HDMI |
|----|------------------------|----------------------------|-------------------------|-------------------------|----------------------------|------|
| 1 | 640x400@70Hz | 31.46 | 70.07 | * (25.17) | | |
| 2 | 640x480@60Hz | 31.47 | 59.94 | * (25.18) | * (25.18) | * |
| 3 | 640x480@72Hz | 37.86 | 72.81 | * (31.5) | | |
| 4 | 640x480@75Hz | 37.50 | 75.00 | * (31.5) | | |
| 5 | 640x480@85Hz | 43.27 | 85.01 | * (36.0) | | |
| 6 | 800x600@56Hz | 35.16 | 56.25 | * (36.0) | | |
| 7 | 800x600@60Hz | 37.88 | 60.32 | * (40.0) | * (40.0) | * |
| 8 | 800x600@72Hz | 48.08 | 72.19 | * (50.0) | | |
| 9 | 800x600@75Hz | 46.88 | 75.00 | * (49.5) | | |
| 10 | 800x600@85Hz | 53.67 | 85.06 | * (56.25) | | |
| 11 | 852x480@60Hz | 31.47 | 59.94 | | * (34.24) | * |
| 12 | 1024x768@50Hz | 39.55 | 50.00 | | * (51.89) | * |
| 13 | 1024x768@60Hz | 48.36 | 60.00 | * (65.0) | * (65.0) | * |
| 14 | 1024x768@70Hz | 56.48 | 70.07 | * (75.0) | | |
| 15 | 1024x768@75Hz | 60.02 | 75.03 | * (78.75) | | |
| 16 | 1024x768@85Hz | 68.68 | 85.00 | * (94.5) | | |
| 17 | 1066x600@60Hz | 37.64 | 59.94 | | * (53.0) | * |
| 18 | 1152x864@60Hz | 53.70 | 60.00 | | * (81.62) | * |
| 19 | 1152x864@75Hz | 67.50 | 75.00 | * (108.0) | | |
| 20 | 1280x768@60Hz | 47.70 | 60.00 | * (80.14) | | |
| 21 | 1280x960@60Hz | 60.00 | 60.00 | * (108.0) | | |
| 22 | 1280x960@85Hz | 85.94 | 85.00 | * (148.5) | | |
| 23 | 1280x1024@60Hz | 63.98 | 60.02 | * (108.0) | * (108.0) | * |
| 24 | 1280x1024@75Hz | 79.98 | 75.02 | * (135.0) | | |
| 25 | 1280x1024@85Hz | 91.15 | 85.02 | * (157.5) *1 | | |
| 26 | 1366x768@50Hz | 39.55 | 50.00 | | * (69.92) | * |
| 27 | 1366x768@60Hz | 48.36 | 60.00 | * (86.71) | * (87.44) | * |
| 28 | 1400x1050@60Hz | 65.22 | 60.00 | | * (122.61) | * |
| 29 | 1600x1200@60Hz | 75.00 | 60.00 | * (162.0) | * (162.0) | * |
| 30 | 1920x1080@60Hz | 67.50 | 60.00 | * (148.5) | * (148.5) | * |
| 31 | 1920x1200@60Hz | 74.04 | 59.95 | | * (154.0) | * |
| 32 | Macintosh13"(640x480) | 35.00 | 66.67 | * (30.24) | | |
| 33 | Macintosh16"(832x624) | 49.72 | 74.55 | * (57.28) | | |
| 34 | Macintosh21"(1152x870) | 68.68 | 75.06 | * (100.0) | | |

*1 Not compatible with Sync on G.

- The signal format automatically detected may differ from the actual input signal in display.
- The corresponding signals for DIGITAL LINK inputs are the same as those for HDMI inputs.

Component signals



*Mark: Applicable input signal



| | Signal name | Horizontal frequency (kHz) | Vertical frequency (Hz) | DVI-D IN (Dot clock (MHz)) | HDMI |
|----|--------------------|----------------------------|-------------------------|----------------------------|------|
| 1 | 525(480)/60i | 15.73 | 59.94 | * (27.0) | * |
| 2 | 525(480)/60p | 31.47 | 59.94 | * (27.0) | * |
| 3 | 625(575)/50i | 15.63 | 50.00 | | |
| 4 | 625(576)/50i | 15.63 | 50.00 | * (27.0) | * |
| 5 | 625(575)/50p | 31.25 | 50.00 | | * |
| 6 | 625(576)/50p | 31.25 | 50.00 | * (27.0) | * |
| 7 | 750(720)/60p | 45.00 | 60.00 | * (74.25) | * |
| 8 | 750(720)/50p | 37.50 | 50.00 | * (74.25) | * |
| 9 | 1,125(1,080)/60p | 67.50 | 60.00 | * (148.5) | * |
| 10 | 1,125(1,080)/60i | 33.75 | 60.00 | * (74.25) | * |
| 11 | 1,125(1,080)/50p | 56.25 | 50.00 | * (148.5) | * |
| 12 | 1,125(1,080)/50i | 28.13 | 50.00 | * (74.25) | * |
| 13 | 1,125(1,080)/24psF | 27.00 | 48.00 | | |
| 14 | 1,125(1,080)/30p | 33.75 | 30.00 | * (74.25) | * |
| 15 | 1,125(1,080)/25p | 28.13 | 25.00 | * (74.25) | * |
| 16 | 1,125(1,080)/24p | 27.00 | 24.00 | * (74.25) | * |

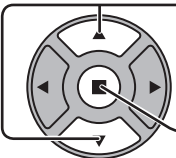

Shipping condition

This function allows you to reset the unit to the factory setting.

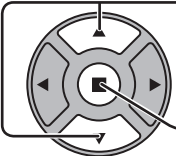
1  Press to display the Setup menu.

2  Press to select "OSD Language".
 Press for more than 3 seconds.

3  Press to select "Shipping".
 Press to display the Shipping menu.

4  Press to select "YES".
 Press to confirm.

5 Wait for 10 seconds.

6  Press the power switch (⏻/⏻) on main unit to turn the power off.
* For TH-47LFX60U and TH-47LFX6NU
If the power switch is locked, please disconnect the AC cord plug from the wall outlet.

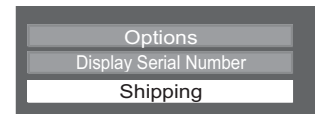
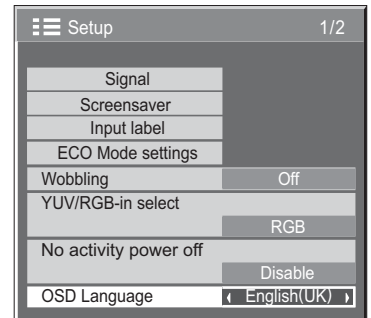

[from the unit]

- 1 Press the MENU button till the Setup menu is displayed.
- 2 Press the Volume Up "+" or Down "-" button to select "OSD Language".
- 3 Press and hold the ENTER button till the Shipping menu is displayed.
- 4 Press the Volume Up "+" or Down "-" button to select "YES".
- 5 Press the ENTER button and wait for 10 sec.
- 6 Press the power switch (⏻/⏻) on main unit to turn the power off.
* For TH-47LFX60U and TH-47LFX6NU
If the power switch is locked, please disconnect the AC cord plug from the wall outlet.

Specifications

| | TH-47LFX60U | TH-47LFX6NU | TH-47LFX60W | TH-47LFX6NW |
|-------------------------------|--|-------------|---|-------------|
| Power Source | 110 - 127 V AC, 50/60 Hz | | 220 - 240 V AC, 50/60 Hz | |
| Power Consumption | | | | |
| Power on | 370 W | 270 W | 370 W | 270 W |
| Power off condition | 0.3 W | | | |
| Stand-by condition | 0.5 W Outdoor mode On: 41 W Network stand-by mode: 16 W | | | |
| LCD Display panel | 47-inch IPS panel, 16:9 aspect ratio | | | |
| Screen size | 40.9" (W) × 23.0" (H) × 46.9" (diagonal) / 1,039 mm (W) × 584 mm (H) × 1,192 mm (diagonal) | | | |
| (No. of pixels) | 2,073,600 (1,920 (W) × 1,080 (H)) [5,760 × 1,080 dots] | | | |
| Operating condition | | | | |
| Temperature | 32 °F - 122 °F / 0 °C - 50 °C* (during Outdoor mode: -4 °F - 122 °F / -20 °C - 50 °C) | | | |
| Humidity | 20 % - 80 % (no condensation) | | | |
| Applicable signals | | | | |
| Scanning format | 525 (480) / 60i · 60p, 625 (575) / 50i · 50p, 750 (720) / 60p · 50p, 1125 (1080) / 60i · 60p · 50i · 50p · 24p · 25p · 30p · 24psF | | | |
| PC signals | VGA, SVGA, XGA, SXGA UXGA ··· (compressed) Horizontal scanning frequency 30 - 110 kHz Vertical scanning frequency 48 - 120 Hz | | | |
| Connection terminals | | | | |
| DIGITAL LINK | For RJ45 network and DIGITAL LINK connections, compatible with PJLink™ Communication method: RJ45 100BaseTX | | | |
| HDMI | TYPE A Connector | | | |
| DVI-D IN | DVI-D 24 Pin Content Protection | | Compliance with DVI Revision 1.0 Compatible with HDCP 1.1 | |
| AUDIO | Stereo mini jack (M3) × 1 | | 0.5 Vrms, Shared with PC IN | |
| PC IN | High-Density Mini D-sub 15 Pin | | G with sync 1.0 Vp-p (75 Ω) G without sync 0.7 Vp-p (75 Ω) B: 0.7 Vp-p (75 Ω) R: 0.7 Vp-p (75 Ω) HD/VD: 1.0 - 5.0 Vp-p (high impedance) 0.5 Vrms, Shared with DVI-D IN | |
| AUDIO | Stereo mini jack (M3) × 1 | | | |
| SERIAL | External Control Terminal D-sub 9 Pin | | RS-232C compatible | |
| AUDIO OUT | L-R RCA PIN JACK × 2 (L / R) Output level: Variable (-∞ — 0 dB) | | [INPUT 1 kHz / 0 dB, 10 kΩ Load] | |
| Dimensions (W × H × D) | 46" × 27.8" × 8.6" 1,162 mm × 706 mm × 216 mm | | | |
| Mass (weight) | approx. 103.7 lbs / 47.0 kg | | | |

Notes:

- Design and specifications are subject to change without notice. Mass and dimensions shown are approximate.
- This equipment complies with the EMC standards listed below.
EN55022, EN55024, EN61000-3-2, EN61000-3-3.
- "DIGITAL LINK" is the technology of transmitting signals from images, sounds, etc. with a twisted pair cable, and the original name of our projector and display.

<Software Information for This Product>

This product has software installed partially licensed under the Free BSD LICENSE.

Free BSD LICENSE regulations under the above specifications are as follows:

(These regulations are set by the third party; therefore the original (English) regulations are stated.)

Copyright © 1980, 1986, 1993

The Regents of the University of California. All rights reserved.

Redistribution and use in source and binary forms, with or without modification, are permitted provided that the following conditions are met:

1. Redistributions of source code must retain the above copyright notice, this list of conditions and the following disclaimer.
2. Redistributions in binary form must reproduce the above copyright notice, this list of conditions and the following disclaimer in the documentation and/or other materials provided with the distribution.
3. All advertising materials mentioning features or use of this software must display the following acknowledgement:
This product includes software developed by the University of California, Berkeley and its contributors.
4. Neither the name of the University nor the names of its contributors may be used to endorse or promote products derived from this software without specific prior written permission.

THIS SOFTWARE IS PROVIDED BY THE REGENTS AND CONTRIBUTORS "AS IS" AND ANY EXPRESS OR IMPLIED WARRANTIES, INCLUDING, BUT NOT LIMITED TO, THE IMPLIED WARRANTIES OF MERCHANTABILITY AND FITNESS FOR A PARTICULAR PURPOSE ARE DISCLAIMED. IN NO EVENT SHALL THE REGENTS OR CONTRIBUTORS BE LIABLE FOR ANY DIRECT, INDIRECT, INCIDENTAL, SPECIAL, EXEMPLARY, OR CONSEQUENTIAL DAMAGES (INCLUDING, BUT NOT LIMITED TO, PROCUREMENT OF SUBSTITUTE GOODS OR SERVICES; LOSS OF USE, DATA, OR PROFITS; OR BUSINESS INTERRUPTION) HOWEVER CAUSED AND ON ANY THEORY OF LIABILITY, WHETHER IN CONTRACT, STRICT LIABILITY, OR TORT (INCLUDING NEGLIGENCE OR OTHERWISE) ARISING IN ANY WAY OUT OF THE USE OF THIS SOFTWARE, EVEN IF ADVISED OF THE POSSIBILITY OF SUCH DAMAGE.

Information for Users on Collection and Disposal of Old Equipment and used Batteries



These symbols on the products, packaging, and/or accompanying documents mean that used electrical and electronic products and batteries should not be mixed with general household waste. For proper treatment, recovery and recycling of old products and used batteries, please take them to applicable collection points, in accordance with your national legislation and the Directives 2002/96/EC and 2006/66/EC.

By disposing of these products and batteries correctly, you will help to save valuable resources and prevent any potential negative effects on human health and the environment which could otherwise arise from inappropriate waste handling.

For more information about collection and recycling of old products and batteries, please contact your local municipality, your waste disposal service or the point of sale where you purchased the items. Penalties may be applicable for incorrect disposal of this waste, in accordance with national legislation.



For business users in the European Union

If you wish to discard electrical and electronic equipment, please contact your dealer or supplier for further information.



[Information on Disposal in other Countries outside the European Union]

These symbols are only valid in the European Union. If you wish to discard these items, please contact your local authorities or dealer and ask for the correct method of disposal.

Note for the battery symbol (bottom two symbol examples):

This symbol might be used in combination with a chemical symbol. In this case it complies with the requirement set by the Directive for the chemical involved.

Cd

USA only: Disposal may be regulated in your community due to environmental considerations. For disposal or recycling information, please visit Panasonic website: <http://www.panasonic.com/environmental> or call 1-888-769-0149.

Customer's Record

The model number and serial number of this product can be found on its rear panel. You should note this serial number in the space provided below and retain this book, plus your purchase receipt, as a permanent record of your purchase to aid in identification in the event of theft or loss, and for Warranty Service purposes.

Model Number _____

Serial Number _____

For TH-47LFX60U and TH-47LFX6NU

Panasonic System Communications Company of North America

Unit of Panasonic Corporation of North America

Executive Office :

Two Riverfront Plaza, Newark, New Jersey 07102-5490

Panasonic Canada Inc.

5770 Ambler Drive
Mississauga, Ontario
L4W 2T3

For TH-47LFX60W and TH-47LFX6NW

Pursuant to the directive 2004/108/EC, article 9(2)

Panasonic Testing Centre

Panasonic Service Europe, a division of Panasonic Marketing Europe GmbH

Winsbergring 15, 22525 Hamburg, F.R. Germany

Panasonic Corporation

Web Site : <http://panasonic.net>

© Panasonic Corporation 2014

M0414-0