

# Panasonic<sup>®</sup>

Model No.  
**TH-47LFX6U**  
**TH-47LFX6W**

## Operating Instructions (Details) FULL HD LCD Display



## HDMI

**English**

Please read these instructions before operating your set  
and retain them for future reference.

## ***Dear Panasonic Customer***

*Welcome to the Panasonic family of customers. We hope that you will have many years of enjoyment from your new LCD Display.*

*To obtain maximum benefit from your set, please read these Instructions before making any adjustments, and retain them for future reference.*

*Retain your purchase receipt also, and note down the model number and serial number of your set in the space provided on the rear cover of these instructions.*

*Visit our Panasonic Web Site      <http://panasonic.net>*

# Precautions for Installation

- Do not install by yourself. Please ask a installation professional or your dealer to install.
- This product corresponds to IP44\*1 dust and water protection standard. Do not change or damage dust or water resistance of the product.
- Please note the dust and water resistance of this product does not guarantee damage or fault free.



## CAUTION

Using with dust or water resistance degraded causes fire, electric shock, or product damage.

This product corresponds to international standard IP rating (Ingress Protection) dust ingress protection level 4 and water ingress protection level 4.

### ■ Terminal cover

After connecting cable etc. of the device to the terminals, check if the terminal cover is sealed correctly and closed firmly using all the fixing screws when attaching the terminal cover.

To seal the terminal cover correctly, be aware of the following points:

**Check if the fixing sealant is fixed in the correct position in the cover. Fixing sealant is an important part to seal the cable part.**

Terminal part on main unit rear side

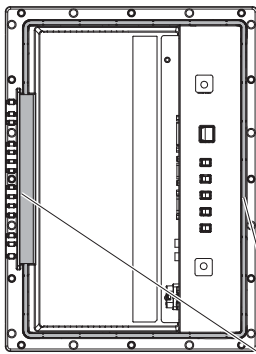

Terminal cover rear side

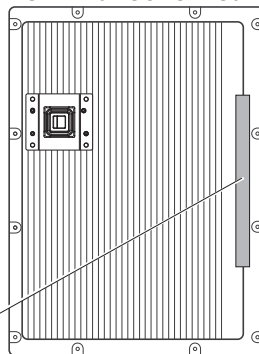

Fixing sealant

### Note:

IPX4 water resistance refers to the capability to prevent the harmful effects of water falling from any directions.

**Stick the cable to the shape of the dent on the terminal strip base tightly.**

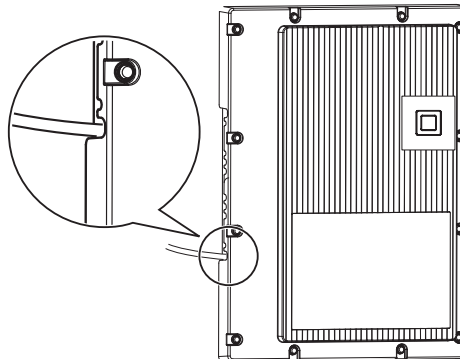
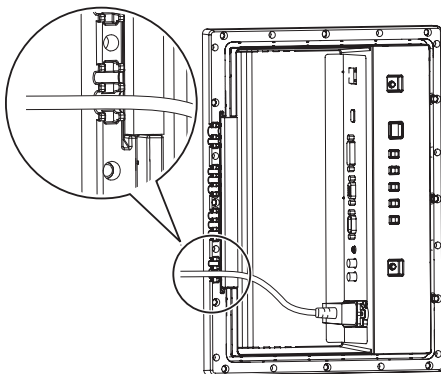

- The structure is to keep the airtightness by tucking the cable pulled out along the dent on the terminal strip base with both fixing sealant of the terminal strip base and terminal cover.

\*1: Based on tests performed by Cosmos Corporation.

# Precautions for Installation

## ■ Protective coating

Cabinet aluminum parts and rear face are protected from corrosion with coating. Be careful not to damage the surface. In case the surface is damaged, corrosion may occur from there.

## ■ Installation position

- When direct sunlight is on the screen, black shadow may appear. This will disappear when the temperature drops.
- To install the product long term in a special environment such as near a swimming pool, hot spring, or ocean, or in a factory uses chemicals or gases, please consult your local Panasonic dealer beforehand.
- The product is equipped with cooling fans and air filters that need to be cleaned or replaced if covered with dust. Removing or installing air filters requires space around the Display. With this in mind, provide adequate space when installing the Display. [Height 7.874"/200 mm or greater, Width 7.874"/200 mm or greater, Depth 7.874"/200 mm or greater]

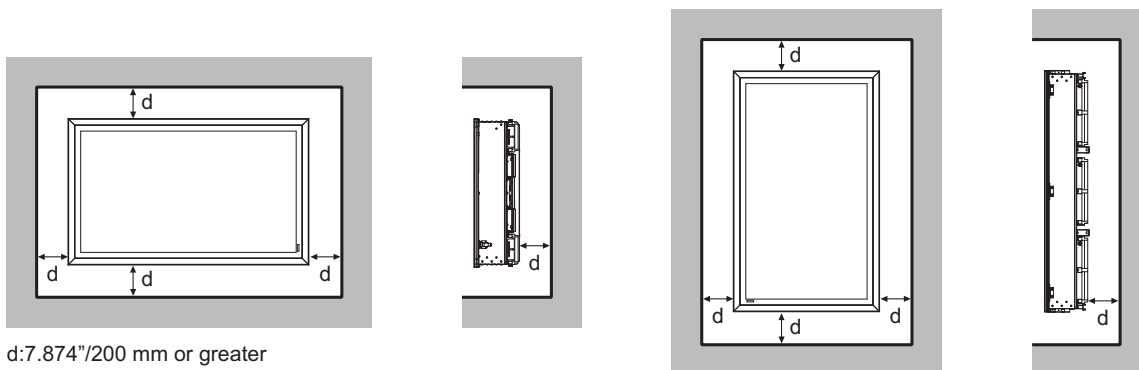

## ■ Installation conditions

To use the product in an environment where outdoor air temperature is lower than 32 °F (0 °C), make sure to set the "Outdoor mode" to "On". The inside temperature is kept constant and the startup can be performed smoothly. (see page 17, 33)

Do not exhibit or use this product in a condition where water splashes on to it continuously for long time.

Always use the product at an ambient temperature in the range of 32 °F - 104 °F / 0 °C - 40 °C (during Outdoor mode: -4 °F - 104 °F / -20 °C - 40 °C).

Set Outdoor mode to "On" if the Display is installed where direct sunlight is on the screen.

## ■ To install on a wall etc.

- Consult your dealer about fittings etc. beforehand.
- Choose a permanent position where the total weight of the product and fittings can be hold permanently. If the strength of the position is not sufficient, a serious accident such as fall may be caused.
- Do not install the product where a person can be hang or lean on, or a passer may collide into. Accident may be caused.
- Take measures for tipping over and fall with an assumption of a fitting or installation location failure.
- Installation strength may be degraded due to aging depends on the environment. Ask a installation professional to inspect or repair regularly.
- When an abnormality or fault such as loose screw is detected, ask an installation professional or your dealer immediately for repair.
- Panasonic will not be responsible for any damages from an accident such as defect of installation, improper use, modification, or natural disaster.



The lightning flash with arrow-head within a triangle is intended to tell the user that parts inside the product are a risk of electric shock to persons.



The exclamation point within a triangle is intended to tell the user that important operating and servicing instructions are in the papers with the appliance.

- WARNING :**
- 1) To prevent electric shock, do not remove cover. No user serviceable parts inside. Refer servicing to qualified service personnel.
  - 2) Do not remove the grounding pin on the power plug. This apparatus is equipped with a three pin grounding-type power plug. This plug will only fit a grounding-type power outlet. This is a safety feature. If you are unable to insert the plug into the outlet, contact an electrician. Do not defeat the purpose of the grounding plug.

# Important Safety Instructions

- 1) Read these instructions.
- 2) Keep these instructions.
- 3) Heed all warnings.
- 4) Follow all instructions.
- 5) Clean only with dry cloth.
- 6) Do not block any ventilation openings. Install in accordance with the manufacturer's instructions.
- 7) Do not install near any heat sources such as radiators, heat registers, stoves, or other apparatus (including amplifiers) that produce heat.
- 8) Do not defeat the safety purpose of the polarized or grounding-type plug. A polarized plug has two blades with one wider than the other. A grounding type plug has two blades and a third grounding prong. The wide blade or the third prong are provided for your safety. If the provided plug does not fit into your outlet, consult an electrician for replacement of the obsolete outlet.
- 9) Protect the power cord from being walked on or pinched particularly at plugs, convenience receptacles, and the point where they exit from the apparatus.
- 10) Only use attachments / accessories specified by the manufacturer.
- 11) Use only with the cart, stand, tripod, bracket, or table specified by the manufacturer, or sold with the apparatus. When a cart is used, use caution when moving the cart / apparatus combination to avoid injury from tip-over.
- 12) Unplug this apparatus during lightning storms or when unused for long periods of time.
- 13) Refer all servicing to qualified service personnel. Servicing is required when the apparatus has been damaged in any way, such as power-supply cord or plug is damaged, liquid has been spilled or objects have fallen into the apparatus, the apparatus has been exposed to rain or moisture, does not operate normally, or has been dropped.
- 14) To prevent electric shock, ensure the grounding pin on the AC cord power plug is securely connected.



# FCC STATEMENT

This equipment has been tested and found to comply with the limits for a Class B digital device, pursuant to Part 15 of the FCC Rules. These limits are designed to provide reasonable protection against harmful interference in a residential installation. This equipment generates, uses and can radiate radio frequency energy and, if not installed and used in accordance with the instructions, may cause harmful interference to radio communications. However, there is no guarantee that interference will not occur in a particular installation. If this equipment does cause harmful interference to radio or television reception, which can be determined by turning the equipment off and on, the user is encouraged to try to correct the interference by one or more of the following measures:

- Reorient or relocate the receiving antenna.
- Increase the separation between the equipment and receiver.
- Connect the equipment into an outlet on a circuit different from that to which the receiver is connected.
- Consult the dealer or an experienced technician for help.

This device complies with Part 15 of the FCC Rules. Operation is subject to the following two conditions: (1) This device may not cause harmful interference, and (2) this device must accept any interference received, including interference that may cause undesired operation.

## **FCC CAUTION:**

**To assure continued compliance, follow the attached installation instructions and use only shielded interface cables when connecting to computer or peripheral devices. Some recommended user provided interface cables may require usage of the attached ferrite core kit(s), refer to interface cable connection instructions for details. Any changes or modifications not expressly approved by Panasonic Corp. of North America could void the user's authority to operate this device.**

### FCC Declaration of Conformity

Model No. TH-47LFX6U

Responsible Party: Panasonic Corporation of North America  
Three Panasonic Way 2F-5, Secaucus, NJ 07094  
Contact Source: Panasonic System Communications Company of North America  
1-885-772-8324

## **CANADIAN NOTICE:**

This Class B digital apparatus complies with Canadian ICES-003.

# Important Safety Notice

## WARNING

- 1) **No naked flame sources, such as lighted candles, should be placed on / above the set.**
- 2) To prevent electric shock, do not remove cover. No user serviceable parts inside. Refer servicing to qualified service personnel.
- 3) Do not remove the earthing pin on the power plug. This apparatus is equipped with a three pin earthing-type power plug. This plug will only fit an earthing-type power outlet. This is a safety feature. If you are unable to insert the plug into the outlet, contact an electrician.  
Do not defeat the purpose of the earthing plug.
- 4) To prevent electric shock, ensure the earthing pin on the AC cord power plug is securely connected.

## CAUTION

This appliance is intended for use in environments which are relatively free of electromagnetic fields. Using this appliance near sources of strong electromagnetic fields or where electrical noise may overlap with the input signals could cause the picture and sound to wobble or cause interference such as noise to appear. To avoid the possibility of harm to this appliance, keep it away from sources of strong electromagnetic fields.

## IMPORTANT: THE MOULDED PLUG (For TH-47LFX6W)

FOR YOUR SAFETY, PLEASE READ THE FOLLOWING TEXT CAREFULLY.

This display is supplied with a moulded three pin mains plug for your safety and convenience. A 10 amp fuse is fitted in this plug. Shall the fuse need to be replaced, please ensure that the replacement fuse has a rating of 10 amps and that it is approved by ASTA or BSI to BS1362.

Check for the ASTA mark  or the BSI mark  on the body of the fuse.

If the plug contains a removable fuse cover, you must ensure that it is refitted when the fuse is replaced.

If you lose the fuse cover the plug must not be used until a replacement cover is obtained.

A replacement fuse cover can be purchased from your local Panasonic dealer.

Do not cut off the mains plug.

Do not use any other type of mains lead except the one supplied with this display.

The supplied mains lead and moulded plug are designed to be used with this display to avoid interference and for your safety.

If the socket outlet in your home is not suitable, get it changed by a qualified electrician.

If the plug or mains lead becomes damaged, purchase a replacement from an authorized dealer.

**WARNING : — THIS DISPLAY MUST BE EARTHED.**

How to replace the fuse. Open the fuse compartment with a screwdriver and replace the fuse.

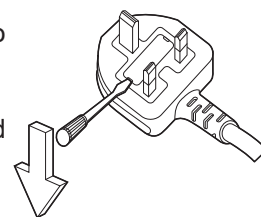



# Table of Contents

Precautions for Installation .....	iii	Customizing the Input labels.....	35
Important Safety Instructions.....	vi	Selecting the On-Screen Menu Language.....	36
FCC STATEMENT.....	vii	Customizing the On-Screen Menu Display .....	36
Important Safety Notice .....	viii	Setup for MULTI DISPLAY.....	37
Safety Precautions .....	2	How to Setup MULTI DISPLAY .....	37
Accessories .....	6	ID Remote Control Function.....	38
Accessories Supply .....	6	Setup for Input Signals .....	39
Remote Control Batteries .....	7	YUV / RGB-in select.....	39
About Power Supply Cord.....	8	Signal menu .....	39
Connections.....	9	Cinema reality* .....	40
How to remove terminal cover.....	9	XGA Mode .....	40
AC cord connection .....	9	Sync .....	40
Video equipment connection .....	10	HDMI Range.....	41
AUDIO OUT connection .....	11	Input signal display.....	41
HDMI connection.....	11	Maintenance information.....	42
DVI-D IN connection.....	12	Network Setup .....	43
PC Input Terminals connection.....	13	Options Adjustments .....	46
SERIAL Terminals connection.....	14	Input Search .....	48
Example connection using the DIGITAL LINK		Using Network Function .....	49
Terminal.....	15	Network Connection .....	49
Power On / Off.....	16	DIGITAL LINK Connections (connecting with a	
Selecting the input signal.....	18	twisted pair cable transmitter) .....	50
Basic Controls .....	19	Command Control .....	51
ASPECT Controls .....	21	PLink™ Protocol.....	51
Digital Zoom.....	22	Using Web Browser Control.....	52
On-Screen Menu Displays .....	23	Before Using Web Browser Control.....	52
Adjusting Pos. /Size .....	24	Access from Web Browser .....	52
Picture Adjustments.....	26	Display Control (BASIC CONTROL/OPTION	
Advanced settings .....	27	CONTROL Screen) .....	53
Sound Adjustment.....	28	NETWORK SETTING (NETWORK SETTING	
PRESENT TIME Setup / Set up TIMER.....	29	Screen).....	54
PRESENT TIME Setup.....	29	Password Setting (CHANGE PASSWORD	
Set up TIMER .....	30	Screen).....	54
Screensaver (For preventing image retention)....	31	Crestron Connected™ page.....	55
Setup of Screensaver Time .....	32	Troubleshooting .....	57
Wobbling .....	32	Applicable Input Signals.....	59
No activity power off .....	33	Shipping condition.....	60
Outdoor mode.....	33	Specifications .....	61
ECO Mode settings.....	34		

## Trademark Credits

- VGA is a trademark of International Business Machines Corporation.
- Microsoft®, Windows®, Windows Vista®, and Internet Explorer® are the registered trademarks or trademarks of Microsoft Corporation in the United States and/or other countries.
- Macintosh, Mac, Mac OS, OS X and Safari are the trademarks of Apple Inc. registered in the United States and other countries.
- SVGA, XGA, SXGA and UXGA are registered trademarks of the Video Electronics Standard Association. Even if no special notation has been made of company or product trademarks, these trademarks have been fully respected.
- HDMI, the HDMI Logo, and High-Definition Multimedia Interface are trademarks or registered trademarks of HDMI Licensing LLC in the United States and other countries.
- RoomView, Crestron RoomView and Fusion RV are registered trademarks of Crestron Electronics, Inc, and Crestron Connected is the trademark of Crestron Electronics, Inc.

## Note:

Image retention may occur. If you display a still picture for an extended period, the image might remain on the screen. However, it will disappear after a while.

# Safety Precautions

## WARNING

### ■ Setup

**This LCD Display is for use only with the following optional accessories. Use with any other type of optional accessories may cause instability which could result in the possibility of injury.**

(All of the following accessories are manufactured by Panasonic Corporation.)

Replacement Air Filter ..... TY-AF6STD

Always be sure to ask a qualified technician to carry out set-up.

Small parts can present choking hazard if accidentally swallowed. Keep small parts away from young children. Discard unneeded small parts and other objects, including packaging materials and plastic bags/sheets to prevent them from being played with by young children, creating the potential risk of suffocation.

**Do not place the Display on sloped or unstable surfaces, and ensure that the Display does not hang over the edge of the base.**

- The Display may fall off or tip over.

**Do not place any objects on top of the Display.**

- If any foreign objects get inside the Display, please consult your local Panasonic dealer.

**Transport only in upright position!**

- Transporting the unit with its display panel facing upright or downward may cause damage to the internal circuitry.

**Ventilation should not be impeded by covering the ventilation openings with items such as newspapers, table cloths and curtains.**

**For sufficient heat release;**

**Leave a space of 7.874" (20 cm) or more at the top, bottom, right, left, and rear to install.**

- Use the product within the operating condition temperature range.
- Do not block any inlet or outlet of the Display.

**Cautions for Wall Installation**

- Wall installation should be performed by an installation professional. Installing the Display incorrectly may lead to an accident that results in death or serious injury. Furthermore, when installing on a wall, a wall hanging bracket that conforms to VESA standards (VESA 400 × 400) must be used.
- When installing the Display vertically, make sure to place the terminal cover downward.

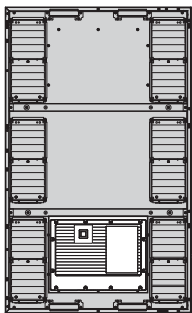

terminal cover

**Install the Display away from any heaters.**

- This causes cabinet deformation and breakdown.

## ■ When using the LCD Display

The Display is designed to operate on 110 - 127 or 220 - 240 V AC, 50/60 Hz.

**Attach the terminal cover firmly to use.**

- Otherwise the dust and water resistance is damaged and may cause fire, electric shock or product damage.

**Do not stick any foreign objects into the Display.**

- Do not insert any metal or flammable objects into the Display or drop them onto the Display, as doing so can cause fire or electric shock.

**Do not remove the cover or modify it in any way.**

- High voltages which can cause severe electric shocks are present inside the Display. For any inspection, adjustment and repair work, please contact your local Panasonic dealer.

**Ensure that the mains plug is easily accessible.**

An apparatus with CLASS I construction shall be connected to a mains socket outlet with a protective earthing connection.

**Do not use any power supply cord other than that provided with this unit.**

- Doing so may cause fire or electric shocks.

**Securely insert the power supply plug as far as it will go.**

- If the plug is not fully inserted, heat may be generated which could cause fire. If the plug is damaged or the wall socket is loose, they shall not be used.

**Do not handle the power supply plug with wet hands.**

- Doing so may cause electric shocks.

**Do not do anything that may damage the power cable. When disconnecting the power cable, pull on the plug body, not the cable.**

- Do not damage the cable, make any modifications to it, place heavy objects on top of it, heat it, place it near any hot objects, twist it, bend it excessively or pull it. To do so may cause fire and electric shock. If the power cable is damaged, have it repaired at your local Panasonic dealer.

**If the Display is not going to be used for any prolonged length of time, unplug the power supply plug from the wall outlet.**

To prevent the spread of fire, keep candles or other open flames away from this product at all times.



## ■ If problems occur during use

**If a problem occurs (such as no picture or no sound), or if smoke or an abnormal odour starts to come out from the Display, immediately unplug the power supply plug from the wall outlet.**

- If you continue to use the Display in this condition, fire or electric shock could result. After checking that the smoke has stopped, contact your local Panasonic dealer so that the necessary repairs can be made. Repairing the Display yourself is extremely dangerous, and shall never be done.

**If foreign objects get inside the Display, if the Display is dropped, or if the cabinet becomes damaged, disconnect the power supply plug immediately.**

- A short circuit may occur, which could cause fire. Contact your local Panasonic dealer for any repairs that need to be made.

## Safety Precautions

---

### CAUTION

#### ■ When using the LCD Display

##### **Be sure to disconnect all cables before moving the Display.**

- If the Display is moved while some of the cables are still connected, the cables may become damaged, and fire or electric shock could result.

##### **Disconnect the power supply plug from the wall socket as a safety precaution before carrying out any cleaning.**

- Electric shocks can result if this is not done.

##### **Clean the power cable regularly to prevent it becoming dusty.**

- If dust built up on the power cord plug, the resultant humidity can damage the insulation, which could result in fire. Pull the power cord plug out from the wall outlet and wipe the mains lead with a dry cloth.

##### **Do not burn or breakup batteries.**

- Batteries must not be exposed to excessive heat such as sunshine, fire or the like.

##### **Power supply**

- Install the product near an electrical outlet so that the plug can be unplugged immediately when an abnormality occurs.
- For a wall installation, used a power outlet which can be unplugged immediately when an abnormality occurs.
- This product is energized when the power plug is inserted to a socket. To cut off the power completely, the power plug must be unplugged from the socket.

##### **Cabinet**

- Corner part of the metal cabinet is a potential injury hazard.
- To lift the product, hold the handles for the precaution of fall. Injury or damage may be caused.

## Cleaning and maintenance

##### **About the glass surface**

- If fingerprints or dirt are on the glass surface, clear image cannot be obtained. Please be careful not to scratch or make it dirty.

**Dirt on the glass can be cleaned with a sponge, cloth or squeegee. Do not use strong acidic or alkaline solution, especially detergent contains fluoride, otherwise the antireflection material on the glass surface will be affected to have irreparable damage.**

**The glass has been specially treated. Wipe the glass gently using only a cleaning cloth or a soft, lint-free cloth.**

- If the glass is particularly dirty, wipe with a soft, lint-free cloth which has been soaked in pure water or water in which neutral detergent has been diluted 100 times, and then wipe it evenly with a dry cloth of the same type until the surface is dry.

**If the cabinet becomes dirty, wipe it with a soft, dry cloth.**

- If the cabinet is particularly dirty, soak the cloth in water to which a small amount of neutral detergent has been added and then wring the cloth dry. Use this cloth to wipe the cabinet, and then wipe it dry with a dry cloth.
- Do not allow any detergent to come into direct contact with the surface of the Display. If water droplets get inside the unit, operating problems may result.
- Avoid contact with volatile substances such as insect sprays, solvents and thinner, otherwise the quality of the cabinet surface may be adversely affected or the coating may peel off. Furthermore, do not leave it for long periods in contact with articles made from rubber or PVC.

## Maintaining air filters

The cooling structure of the Display is designed to circulate air taken in from outside inside the Display using fans. Air filters are built into the inlet and outlet.

When “Filter” is displayed on the screen as you turn on the power, or when the power indicator is blinking green and orange alternately, there is accumulated dust on the air filters. Check the condition of the air filter and fan in “Maintenance Information” in the Setup menu, and clean or replace the air filter and inspect the fan as necessary. (see page 42)



### ■ How to remove air filters

Always unplug the power plug before removing air filters.

- 1 Loosen the decorative screws on the exhaust vent sections until they turn freely.

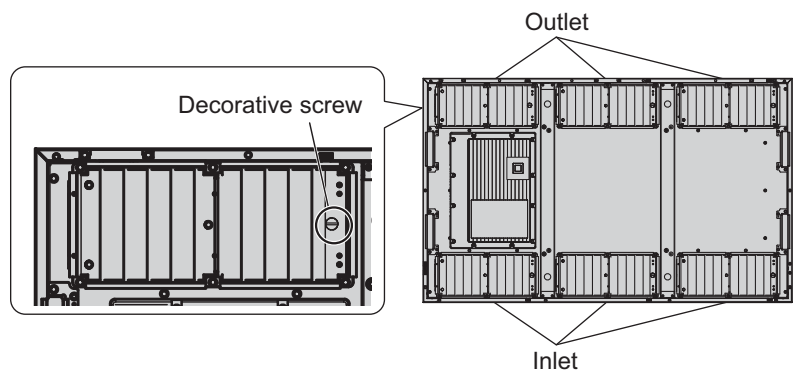

- 2 Remove the filter cover, and pull out the air filter.

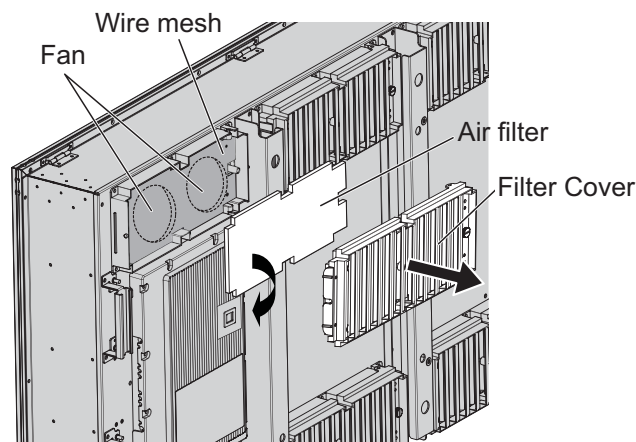

• There is no fan in the inlet.

### Cleaning air filters

To clean the air filter, soak in a neutral detergent diluted 200 times with water, rinse well in water, and leave to dry in the shade.

#### Notes:

- Air filters must be installed before using the Display. The absence of an air filter may cause failure in the Display due to the intake of foreign matter or dust.
- When an air filter is damaged or is unobtrusively soiled even after cleaning, replace the air filter with a new one. Contact your sales agent for replacement.
- The amount of foreign matter or dust adhering to air filters varies depending on the installation location and the used hours. Increase the frequency of cleaning in locations where dust can easily accumulate.
- Do not remove the wire mesh below the air filter.
- Do not touch the fans or wiring inside the Display.
- When removing air filters from or installing into the Display set on a high place, take care of your own safety, and avoid the concerned parts falling.
- Clean the air filters approximately once every 3 months and replace them approximately once a year.

# Accessories

## Accessories Supply

Check that you have the accessories and items shown



Operating Instruction book

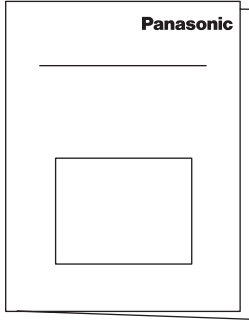

Remote Control Transmitter  
N2QAYB000691



Batteries for the Remote Control Transmitter  
(R6 (UM3, AA) Size × 2)

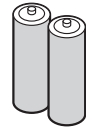

**Note:**

Remote Control Transmitter is not water protection type.

Power supply cord

Main plug types vary between countries. Make sure to use the power supply cord with the voltage and shape appropriate to your country and region. (see page 8)

Door holders × 2

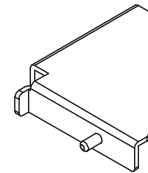

Panasonic badge

An installation professional or service provider will attach it to the Display frame at the time of installation.

Used by a service provider during maintenance work.

Ferrite core × 2  
J0KG00000014

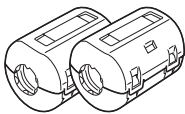

Use the Ferrite cores to comply with the EMC standard.  
(see page 12)

Cable tie × 2  
TMM17499



Screws × 12  
XYN4+F10VM



## Remote Control Batteries

**Requires two R6 batteries.**

1. Pull and hold the hook, then open the battery cover.
2. Insert batteries - note correct polarity ( + and -).
3. Replace the cover.

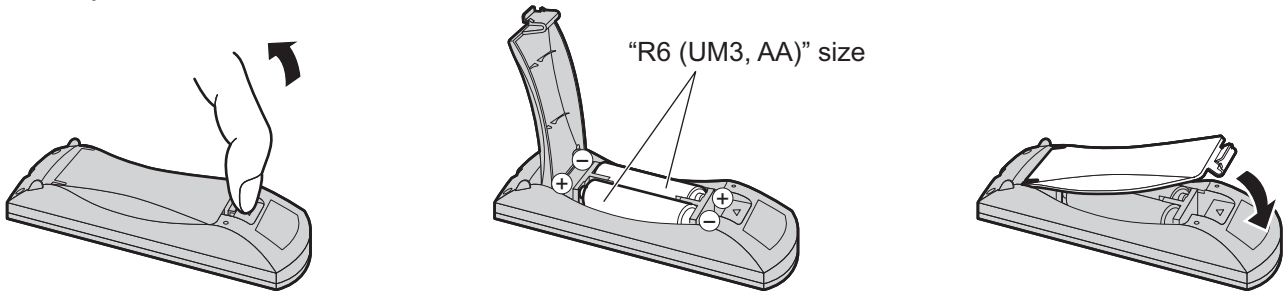
**Helpful Hint:**

For frequent remote control users, replace old batteries with Alkaline batteries for longer life.

**⚠ Precaution on battery use**

Incorrect installation can cause battery leakage and corrosion that will damage the remote control transmitter. Disposal of batteries should be in an environment-friendly manner.

**Observe the following precaution:**

1. Batteries shall always be replaced as a pair. Always use new batteries when replacing the old set.
2. Do not combine a used battery with a new one.
3. Do not mix battery types (example: "Zinc Carbon" with "Alkaline").
4. Do not attempt to charge, short-circuit, disassemble, heat or burn used batteries.
5. Battery replacement is necessary when remote control acts sporadically or stops operating the Display set.
6. Do not burn or breakup batteries.  
Batteries must not be exposed to excessive heat such as sunshine, fire or the like.

## About Power Supply Cord

Main plug types vary between countries. Check the shape of the power plugs to choose the appropriate cable for you.

Country name and applicable model name	Appropriate AC Cables	
Asia		
TH-47LFX6W	India	Cable B or Cable C
	Indonesia	
	Philippine	
	Malaysia	
	Singapore	
Hong Kong	Cable C	
Middle East		
TH-47LFX6W	United Arab Emirates	Cable B or Cable C
	Iraq	
	Iran	
	Oman	
	Syria	
	Lebanon	
	Qatar	
	Kuwait	
Saudi Arabia	Cable C	
Africa		
TH-47LFX6W	Egypt	Cable B or Cable C
	Ethiopia	
	South Africa	
Middle/South America		
TH-47LFX6U	Uruguay	Cable A
	Ecuador	
	Colombia	
	Chili	
	Panama	
	Paraguay	
	Puerto Rico	
	Venezuela	
	Peru	
	Bolivia	
	Honduras	
North America		
TH-47LFX6U	USA	Cable A (110-127 V AC Compatible)
	Canada	
Europe		
TH-47LFX6W	Italy	Cable B
	Austria	
	Netherlands	
	Greece	
	Switzerland	
	Sweden	
	Spain	
	Czech	
	Denmark	
	Germany	
	Norway	
	Hungary	
	Finland	
	France	
	Bulgaria	
	Belgium	
	Portugal	
	Poland	
	Monaco	
	Luxembourg	
	Russia	
	Kazakhstan	
	Ukraine	
Belarus		
UK	Cable C	
Oceania		
TH-47LFX6W	Australia	Cable D
	New Zealand	

### TH-47LFX6U:

#### Cable A

Plug Type : A

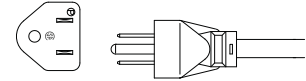

### TH-47LFX6W:

#### Cable B

Plug Type : SE

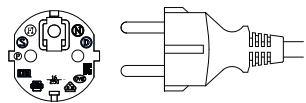

#### Cable C

Plug Type : BF

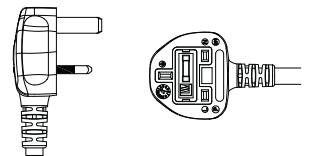

#### Cable D

Plug Type : O

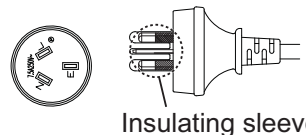

### Note:

Depending on the country of destination, relay type or direct attached type of the power supply cord is used.



# Connections

## How to remove terminal cover

A terminal cover is attached to the input and output terminals to protect them from dust and water. To remove the terminal cover to connect a cable or other item, remove all 12 screws from the terminal cover. Opening the terminal cover with some screws left on will damage the terminal cover.

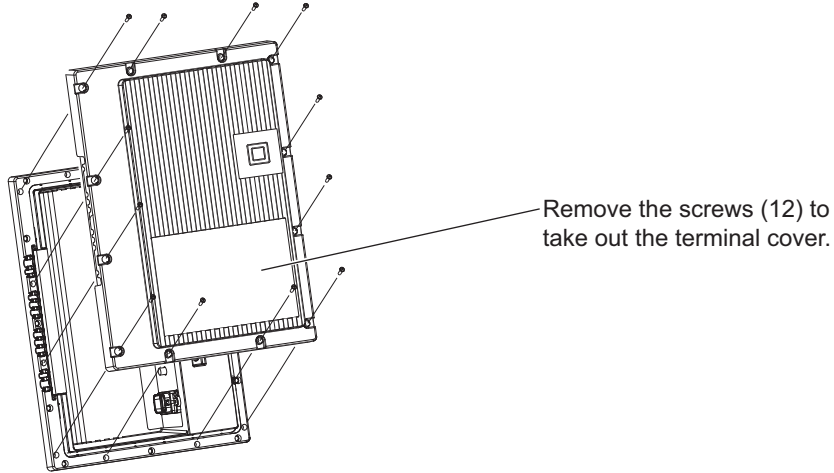

## AC cord connection

### Notes:

- After connection, check the cable is pulled out along the groove without overlapping, then tighten the all 12 screws to attach the terminal cover correctly. Otherwise water enters inside and causes fire, electric shock and product damage.
- Make sure to read the "Terminal cover" (page iii) section for the correct handling of the terminal cover to use the product properly.

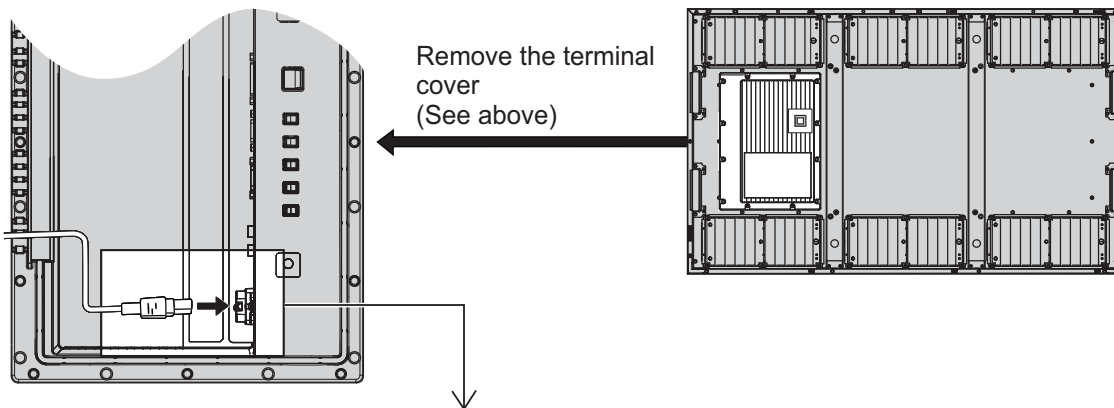

### AC cord fixing

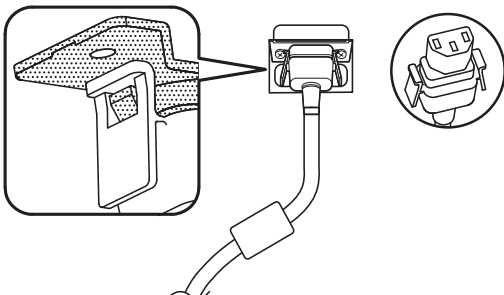

### Plug the AC cord into the display unit.

Plug the AC cord until it clicks.

### Note:

Make sure that the AC cord is locked on both the left and right sides.

### Unplug the AC cord

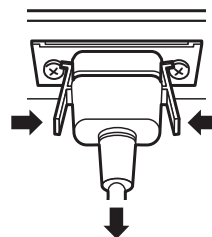

Unplug the AC cord pressing the two knobs.

### Note:

When disconnecting the AC cord, be absolutely sure to disconnect the AC cord plug at the socket outlet first.

## Video equipment connection

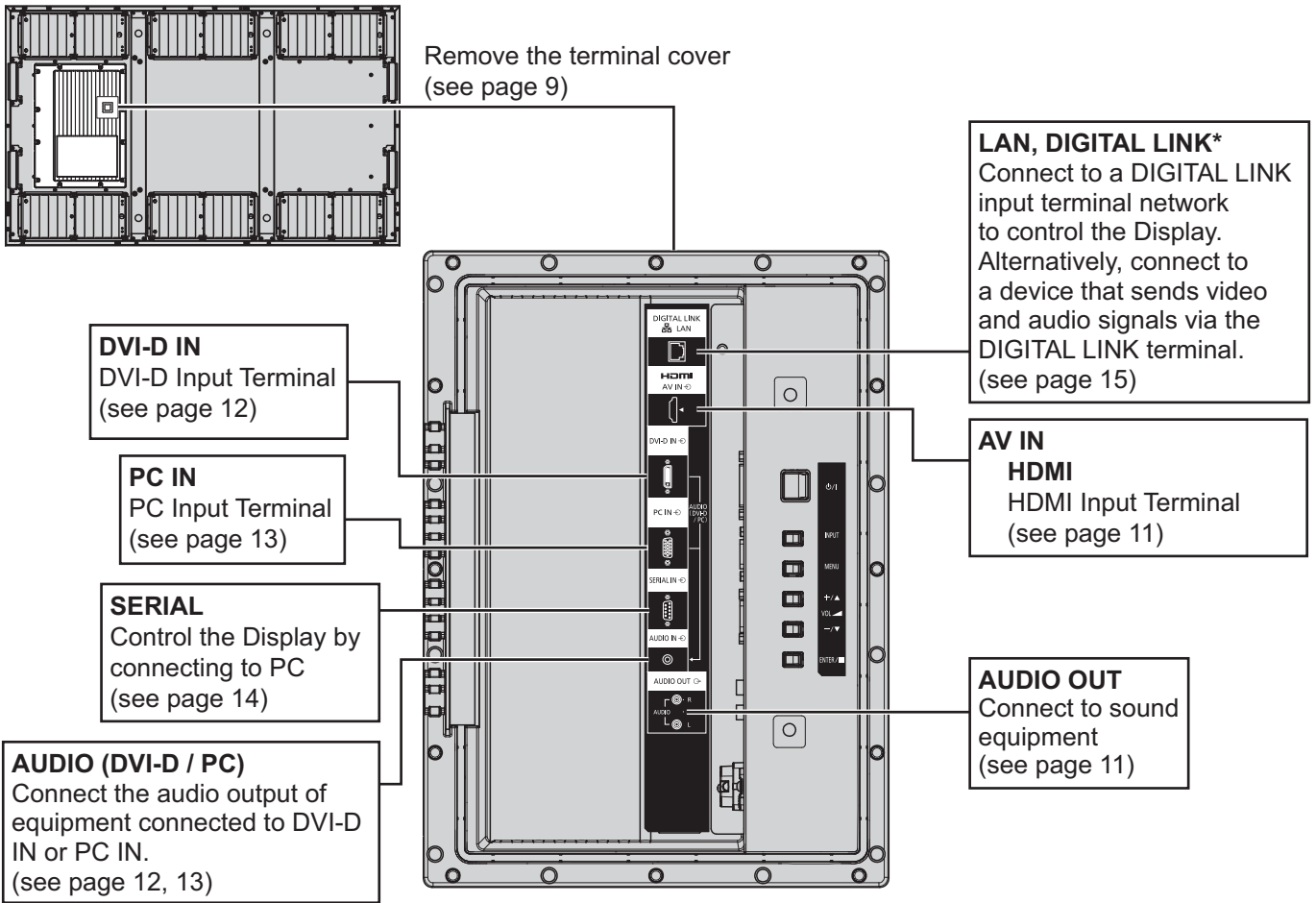

**Note:**

\* DIGITAL LINK is technology that enables signals such as audio and video to be transmitted using twisted pair cables. (see page 15, 50)

- Use the screw holes shown in the figures below for such purposes as mounting the brackets for cabling if necessary. (Use the supplied screws for screw holes.)

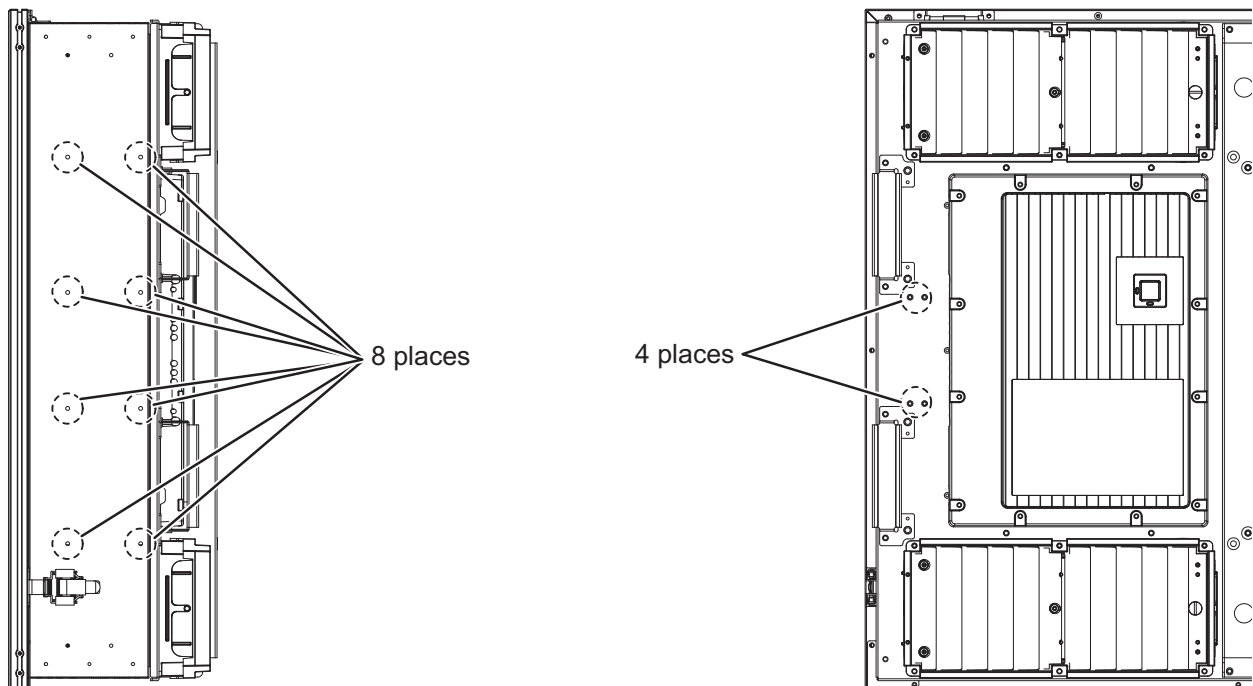

# AUDIO OUT connection

**Note:**

Additional equipment and cables shown are not supplied with this set.

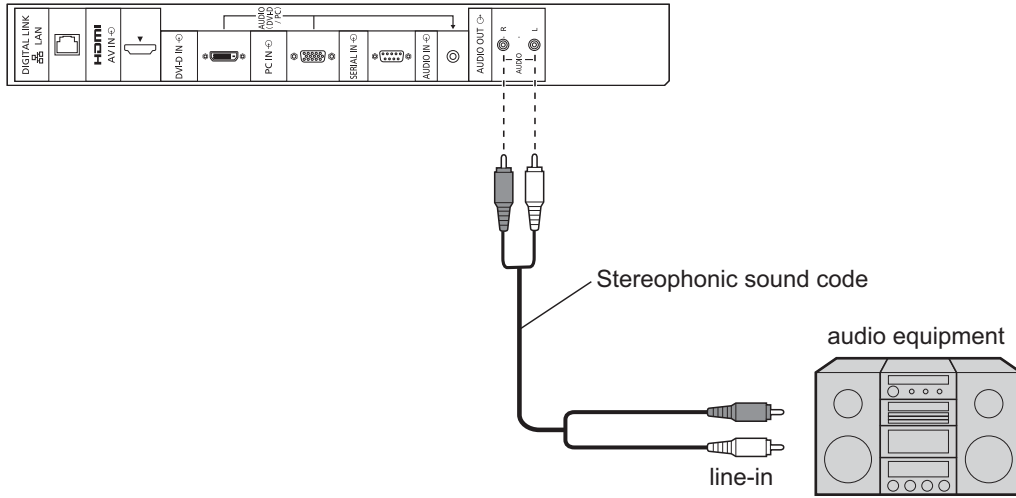

# HDMI connection

[Pin assignments and signal names]

Pin No.	Signal Name	Pin No.	Signal Name
①	T.M.D.S Data2+	⑪	T.M.D.S Clock Shield
②	T.M.D.S Data2 Shield	⑫	T.M.D.S Clock-
③	T.M.D.S Data2-	⑬	CEC
④	T.M.D.S Data1+	⑭	Reserved (N.C. on device)
⑤	T.M.D.S Data1 Shield		
⑥	T.M.D.S Data1-	⑮	SCL
⑦	T.M.D.S Data0+	⑯	SDA
⑧	T.M.D.S Data0 Shield	⑰	DDC/CEC Ground
⑨	T.M.D.S Data0-	⑱	+5V Power
⑩	T.M.D.S Clock+		Hot Plug Detect

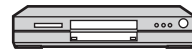

DVD player



HDMI AV OUT



HDMI cables

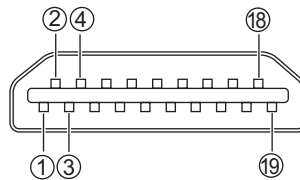
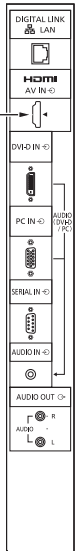

**Note:**

Additional equipment and HDMI cable shown are not supplied with this set.

## DVI-D IN connection

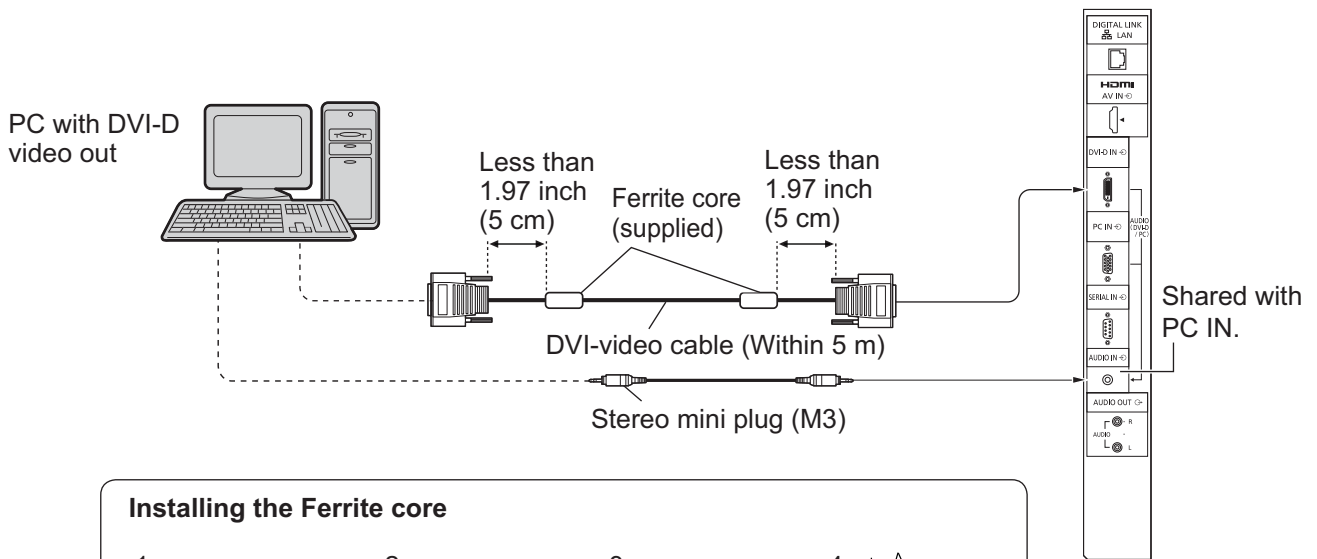

**Installing the Ferrite core**

- Pull back the tabs (in two places)
- Open the Ferrite core
- Route the cable through and close
- Fix the Ferrite core with the cable tie

### DVI-D Input Connector Pin Layouts

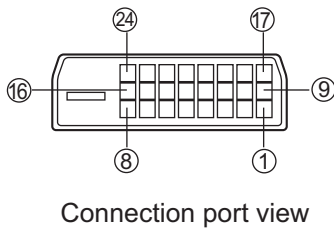

Pin No.	Signal Name	Pin No.	Signal Name
①	T.M.D.S. data 2-	⑬	_____
②	T.M.D.S. data 2+	⑭	+5 V DC
③	T.M.D.S. data 2 shield	⑮	Ground
④	_____	⑯	Hot plug detect
⑤	_____	⑰	T.M.D.S. data 0-
⑥	DDC clock	⑱	T.M.D.S. data 0+
⑦	DDC data	⑲	T.M.D.S. data 0 shield
⑧	_____	⑳	_____
⑨	T.M.D.S. data 1-	㉑	_____
⑩	T.M.D.S. data 1+	㉒	T.M.D.S. clock shield
⑪	T.M.D.S. data 1 shield	㉓	T.M.D.S. clock+
⑫	_____	㉔	T.M.D.S. clock-

**Note:**

Additional equipment and cables shown are not supplied with this set.

# PC Input Terminals connection

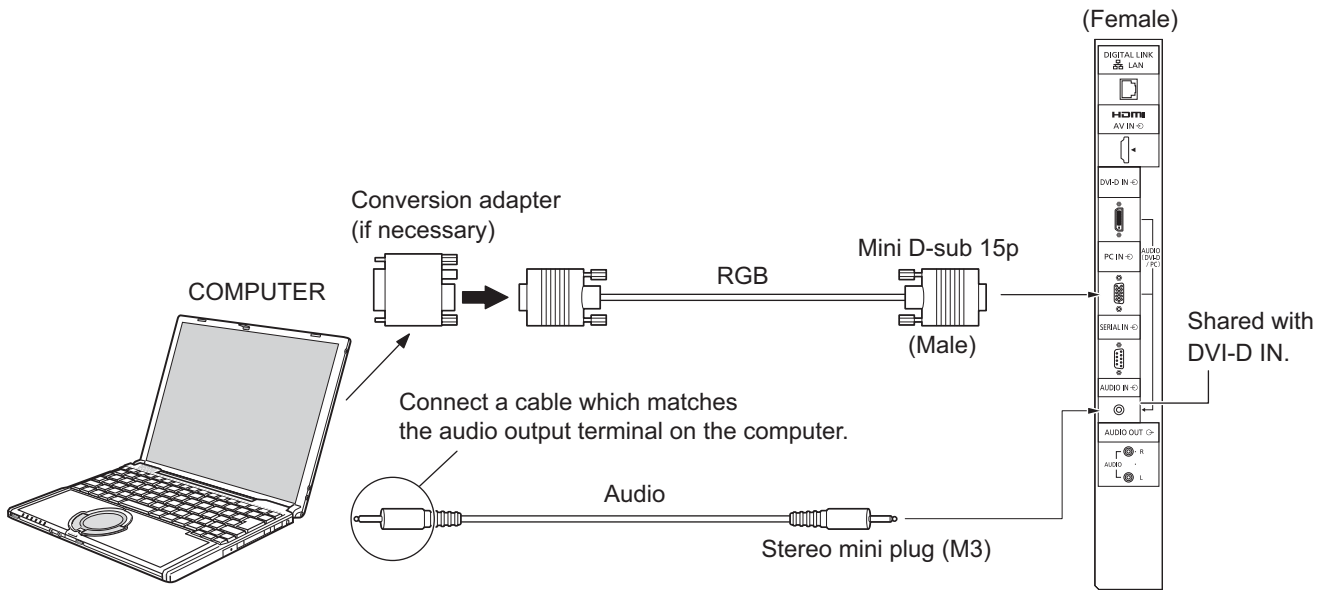

**Notes:**

- Computer signals which can be input are those with a horizontal scanning frequency of 30 to 110 kHz and vertical scanning frequency of 48 to 120 Hz. (However, the image will not be displayed properly if the signals exceed 1,200 lines.)
- The display resolution is a maximum of 1,440 × 1,080 dots when the aspect mode is set to “4:3”, and 1,920 × 1,080 dots when the aspect mode is set to “16:9”. If the display resolution exceeds these maximums, it may not be possible to show fine detail with sufficient clarity.
- The PC input terminals are DDC2B-compatible. If the computer being connected is not DDC2B-compatible, you will need to make setting changes to the computer at the time of connection.
- Some PC models cannot be connected to the set.
- There is no need to use an adapter for computers with DOS/V compatible Mini D-sub 15P terminal.
- The computer shown in the illustration is for example purposes only.
- Additional equipment and cables shown are not supplied with this set.
- Do not set the horizontal and vertical scanning frequencies for PC signals which are above or below the specified frequency range.

**Signal Names for Mini D-sub 15P Connector**

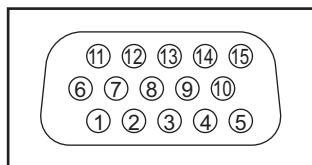

Pin Layout for PC Input Terminal

Pin No.	Signal Name	Pin No.	Signal Name	Pin No.	Signal Name
①	R	⑥	GND (Ground)	⑪	NC (not connected)
②	G	⑦	GND (Ground)	⑫	SDA
③	B	⑧	GND (Ground)	⑬	HD/SYNC
④	NC (not connected)	⑨	+5 V DC	⑭	VD
⑤	GND (Ground)	⑩	GND (Ground)	⑮	SCL

## SERIAL Terminals connection

The SERIAL terminal is used when the Display is controlled by a computer.

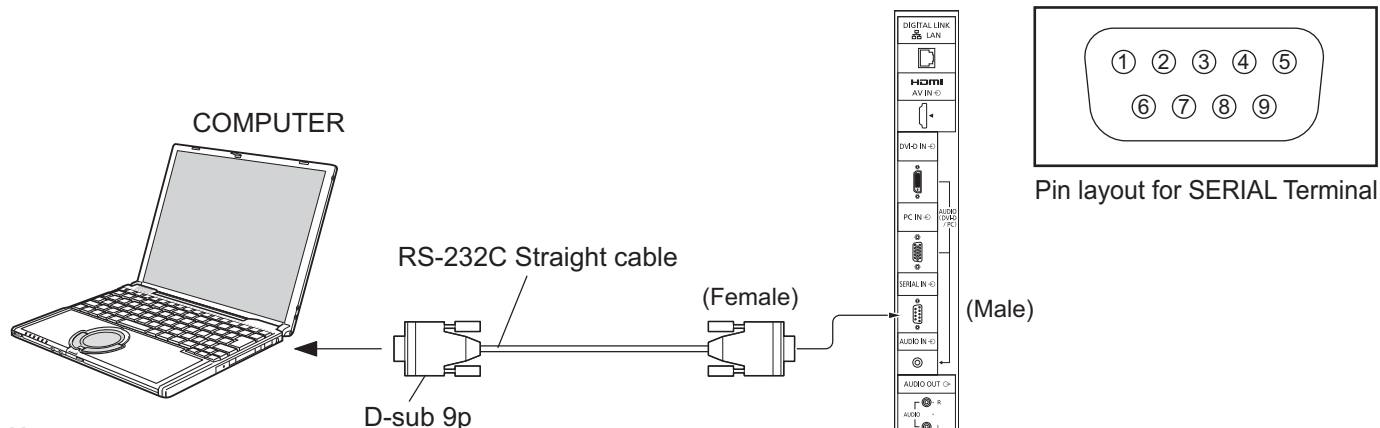

### Notes:

- Use the RS-232C straight cable to connect the computer to the Display.
- The computer shown is for example purposes only.
- Additional equipment and cables shown are not supplied with this set.
- When using serial control with this display, be sure to configure the “Control I/F Select” in the “Network Setup” menu. When controlling the Display with RS232C terminal, select “RS-232C (Serial)”. When controlling with the RS232C terminal of a DIGITAL LINK device, select “RS232C(DIGITAL LINK)”. (see page 43)

The SERIAL terminal conforms to the RS-232C interface specification, so that the Display can be controlled by a computer which is connected to this terminal.

The computer will require software which allows the sending and receiving of control data which satisfies the conditions given below. Use a computer application such as programming language software. Refer to the documentation for the computer application for details.

### Communication parameters

Signal level	RS-232C compliant
Synchronization method	Asynchronous
Baud rate	9600 bps
Parity	None
Character length	8 bits
Stop bit	1 bit
Flow control	None

### Basic format for control data

The transmission of control data from the computer starts with a STX signal, followed by the command, the parameters, and lastly an ETX signal in that order. If there are no parameters, then the parameter signal does not need to be sent.

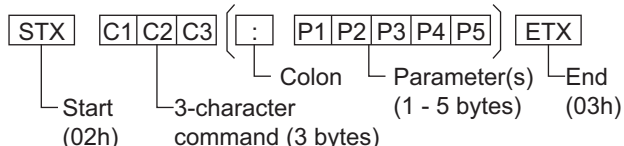

### Notes:

- If multiple commands are transmitted, be sure to wait for the response for the first command to come from this unit before sending the next command.
- If an incorrect command is sent by mistake, this unit will send an “ER401” command back to the computer.
- Consult an Authorized Service Center for detail instructions on command usage.

### Signal names for D-sub 9P connector

Pin No.	Details
②	R X D
③	T X D
⑤	GND
④ • ⑥	Non use
⑦ ⑧	(Shorted in this set)
① • ⑨	NC

These signal names are those of computer specifications.

### Command

Command	Parameter	Control details
PON	None	Power ON
POF	None	Power OFF
AVL	***	Volume 000 - 100
AMT	0	Audio MUTE OFF
	1	Audio MUTE ON
IMS	None	Input select (toggle)
	HM1	HDMI input (HDMI)
	DV1	DVI-D IN input (DVI)
	PC1	PC IN input (PC)
	DL1	DIGITAL LINK input
DAM	None	Screen mode select (toggle)
	ZOOM	Zoom1
	FULL	16:9
	NORM	4:3
	ZOM2	Zoom2

With the power off, this display responds to PON command only.

## Example connection using the DIGITAL LINK Terminal

A twisted pair cable transmitter such as the **Panasonic Digital Interface Box (ET-YFB100)** uses **twisted pair cables to transmit inputted video and audio signals**, and these digital signals can be input to the Display via the DIGITAL LINK terminal.

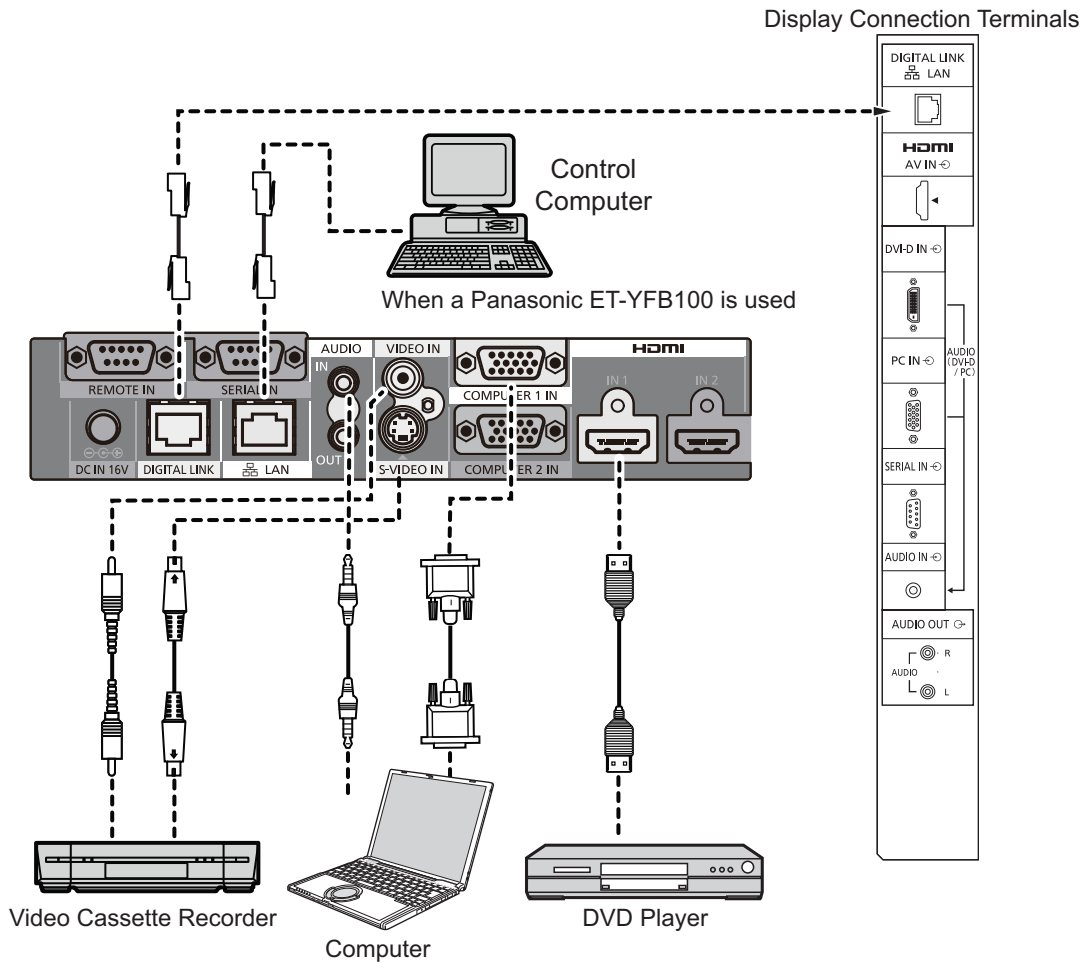

**Notes:**

- When connecting with DIGITAL LINK, be sure to configure each of the “Network Setup” settings. (see page 43-45)
- For details on precautions related to connecting to the DIGITAL LINK terminals, see “connecting with a twisted pair cable transmitter”. (see page 50)

# Power On / Off

## Connecting the AC cord plug to the Display.

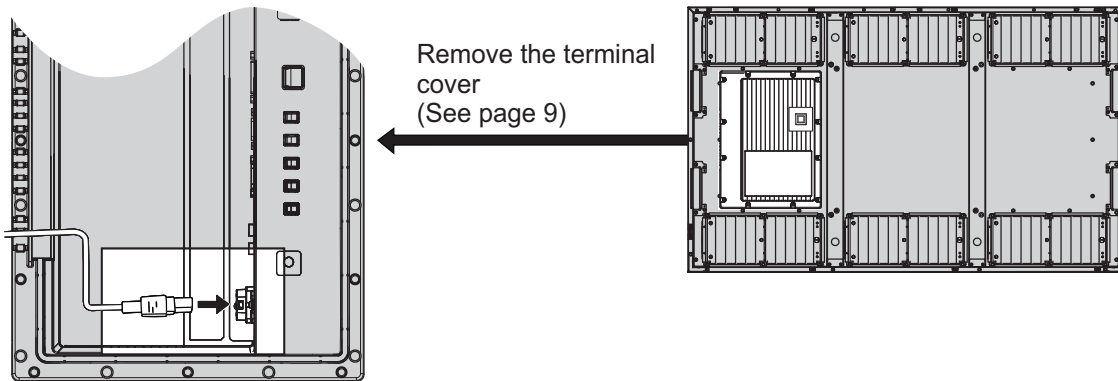

## Connecting the plug to the Wall Outlet

### Notes:

- Main plug types vary between countries. The power plug shown at right may, therefore, not be the type fitted to your set.
- When disconnecting the AC cord, be absolutely sure to disconnect the AC cord plug at the socket outlet first.

Press the Power switch on the Display to turn the set on: Power-On.

Power Indicator: Green

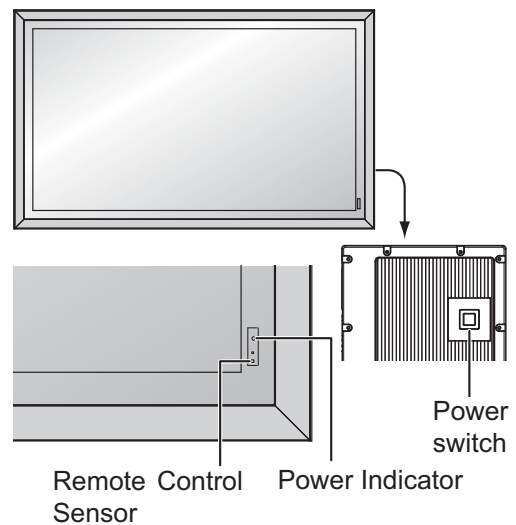

POWER



Press the  button on the remote control to turn the Display off.

Power Indicator: Red (standby)

Press the  button on the remote control to turn the Display on.

Power Indicator: Green

Turn the power to the Display off by pressing the  switch on the unit, when the Display is on or in standby mode.

### Note:

During operation of the power management function, the power indicator turns orange in the power off state.





**When first switching on the unit**

Following screen will be displayed when the unit is turned on for the first time. Select the items with the remote control. Unit buttons are invalid.

**OSD Language**

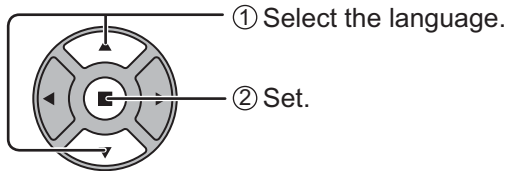

**PRESENT TIME Setup**

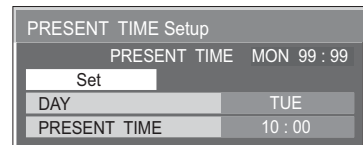
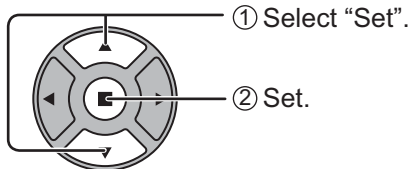
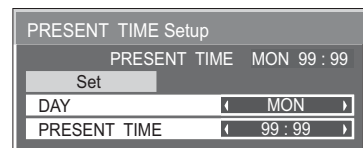
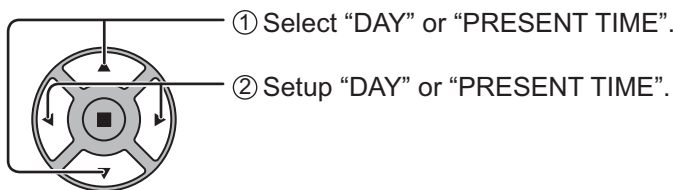

**Outdoor mode**

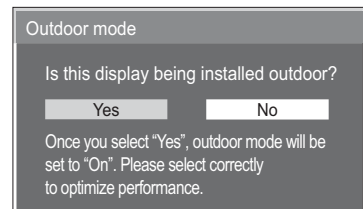
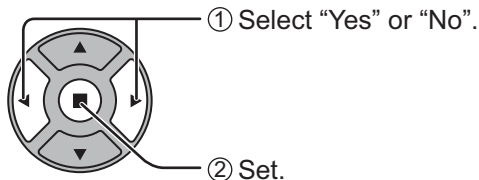

**Notes:**

- Once the items are set, the screens won't be displayed when switching on the unit next time.
- After the setting, the items can be changed in the following menus.  
OSD Language (see page 36)  
PRESENT TIME Setup (see page 29)  
Outdoor mode (see page 33)

**Power ON warning message**

The following message may be displayed when turning the unit power ON:

**No activity power off Precautions**



If "No activity power off" in Setup menu is set to "Enable", a warning message is displayed every time the power is turned ON. (see page 33)

This message display can be set with the following menu: Options menu

Power On Message (see page 48)

# Selecting the input signal

INPUT



Press to select the input signal to be played back from the equipment which has been connected to the Display.

Input signals will change as follows:

→ HDMI → PC → DVI → DIGITAL LINK →

HDMI: HDMI input terminal in AV IN (HDMI).

PC: PC input terminal in PC IN.

DVI: DVI input terminal in DVI-D IN.

DIGITAL LINK: DIGITAL LINK input to DIGITAL LINK terminal



## Note:

Selecting is also possible by pressing the INPUT button on the unit.

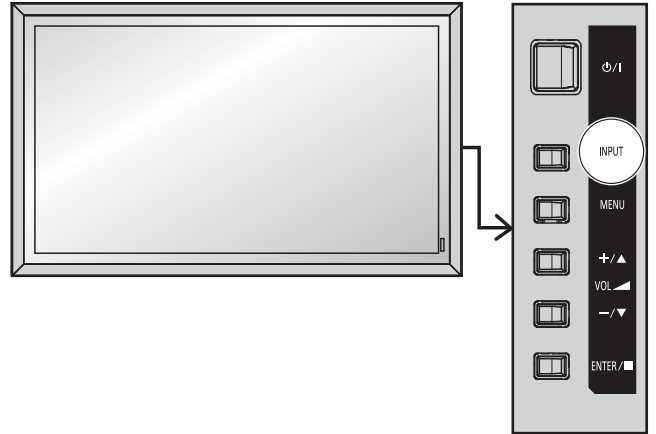

# Basic Controls

## Main Unit

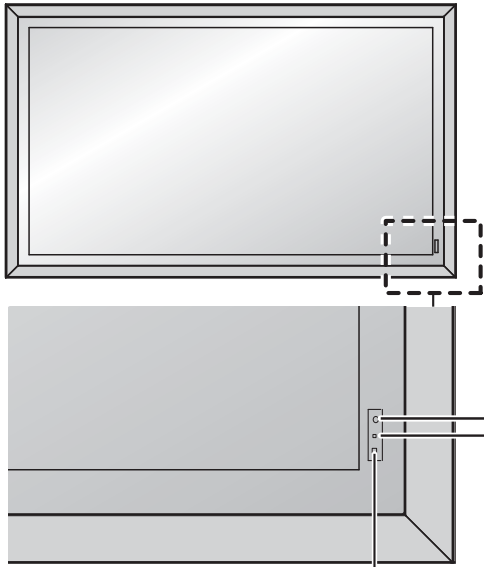

Remote control sensor

### Power Indicator

The Power Indicator will light.

- Power-OFF .... Indicator not illuminated (The unit will still consume some power as long as the power cord is still inserted into the wall outlet.)
- Standby ..... Red  
Orange (When the control terminal selection is "LAN" or "RS-232C(DIGITAL LINK)". See page 43)  
Orange (When Outdoor mode is set to "ON". See page 33)
- Power-ON ..... Green
- PC Power management (DPMS)  
.....Orange (With PC input signal. See page 34)
- DVI-D Power management  
.....Orange (With DVI input signal. See page 34)
- When dust has accumulated on the air filters  
.....Green and orange blink alternately (See page 5)

### Brightness Sensor

Detects the brightness in the viewing environment.

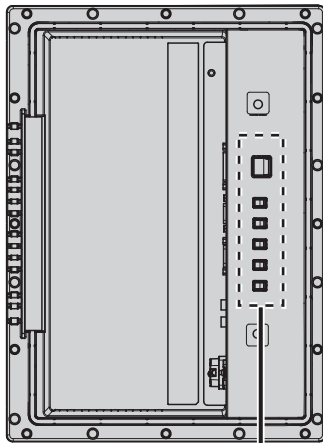

Remove the terminal cover (see page 9)

Outlet (air filter, fan)  
(see page 5)

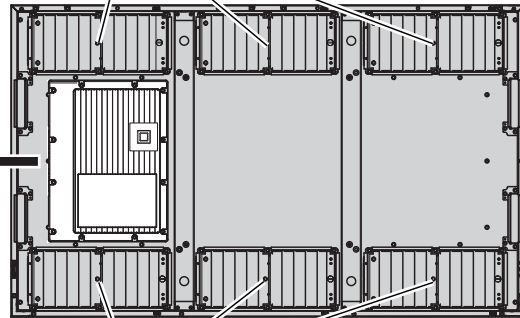

Inlet (air filter)  
(see page 5)

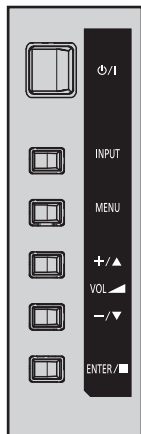

### Main Power On / Off Switch

### INPUT button (INPUT signal selection) (see page 18)

### MENU Screen ON / OFF

Each time the MENU button is pressed, the menu screen will switch. (see page 23)

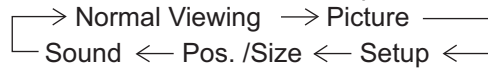

### Volume Adjustment

Volume Up "+" Down "-"

When the menu screen is displayed:

"+": press to move the cursor up

"-": press to move the cursor down

(see page 23)

### Enter / Aspect button

(see page 21, 23)

## Remote Control Transmitter

**ACTION button**  
Press to make selections.

**ASPECT button**  
Press to adjust the aspect.  
(see page 21)

**Standby (ON / OFF) button**  
The Display must first be plugged into the wall outlet and turned on at the power switch (see page 16). Press this button to turn the Display On, from Standby mode. Press it again to turn the Display Off to Standby mode.

**POS. /SIZE button**  
(see page 24, 25)

**PICTURE button**  
(see page 26, 27)

**Sound mute On / Off**  
Press this button to mute the sound.  
Press again to reactivate sound.  
Sound is also reactivated when power is turned off or volume level is changed.

**N button**  
(see page 25, 26, 27, 28)

**POSITION buttons**

**INPUT button**  
Press to select Input signal sequentially. (see page 18)

**ECO MODE (ECO)**  
Press to change the ECO MODE setup status. (see page 34)

**FUNCTION buttons (FUNCTION)**  
(see page 48)

### OFF TIMER button

The Display can be preset to switch to stand-by after a fixed period. The setting changes to 30 minutes, 60 minutes, 90 minutes and 0 minutes (off timer cancelled) each time the button is pressed.

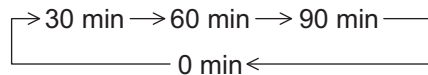

When three minutes remain, "Off timer 3 min" will flash.

The off timer is cancelled if a power interruption occurs.

### AUTO SETUP button

Automatically adjusts the position/size of the screen. (see page 24)

**SET UP button** (see page 29 - 45)

**SOUND button** (see page 28)

### Volume Adjustment

Press the Volume Up "+" or Down "-" button to increase or decrease the sound volume level.

**R button** (see page 23)

Press the R button to return to previous menu screen.

### RECALL button

Press the "RECALL" button to display the current system status.

- ① Input label
- ② Aspect mode (see page 21)
- ③ Air filter conditions (see page 5)
- ④ Off timer

The off timer indicator is displayed only when the off timer has been set.

- ⑤ Clock Display (see page 47)

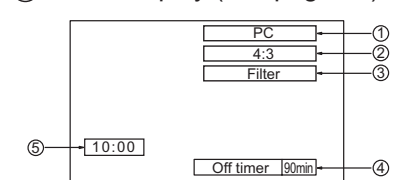

**Digital Zoom** (see page 22)

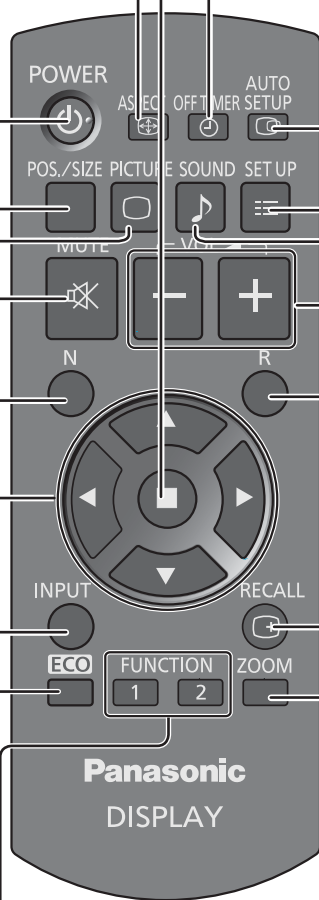

# ASPECT Controls

The Display will allow you to enjoy viewing the picture at its maximum size, including wide screen cinema format picture.

**Note:**

Be aware that if you put the display in a public place for commercial purposes or a public showing and then use the aspect mode select function to shrink or expand the picture, you may be violating the copyright under copyright law. It is prohibited to show or alter the copyrighted materials of other people for commercial purposes without the prior permission of the copyright holder.



ASPECT



Press repeatedly to move through the aspect options:

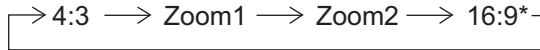

[from the unit]

**Right side surface**

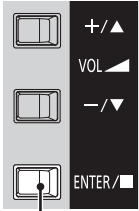

The aspect mode changes each time the ENTER button is pressed.

**Note:**

The aspect mode is memorized separately for each input terminal.

Aspect mode	Picture → Enlarged screen	Description
16:9*		The display of the pictures fills the screen. In the case of SD signals, pictures with a 4:3 aspect ratio are enlarged horizontally, and displayed. This mode is suited to displaying anamorphic pictures with a 16:9 aspect ratio.
4:3		Pictures with a 4:3 aspect ratio are displayed with their original aspect ratio. Side panels are displayed at the left and right edges of the screen.
		The pictures with a 4:3 aspect ratio among the 16:9 aspect ratio signals are displayed with their original aspect ratio. The left and right edges of the pictures are masked with side panels.
Zoom1		Letterbox pictures with a 16:9 aspect ratio are enlarged vertically and horizontally so that their display fills the screen. The top and bottom edges of the pictures are cut off.
Zoom2		Letterbox pictures with a 16:9 aspect ratio are enlarged vertically and horizontally so that their display fills the screen. The top and bottom edges as well as the left and right edges of the pictures are cut off.

\* In "ENGLISH (US)" OSD language, this is displayed as "FULL".

# Digital Zoom

This displays an enlargement of the designated part of the displayed image.

## 1 Display the operation guide.

**ZOOM**  
 Press to access Digital Zoom.  
 The operation guide will be displayed.

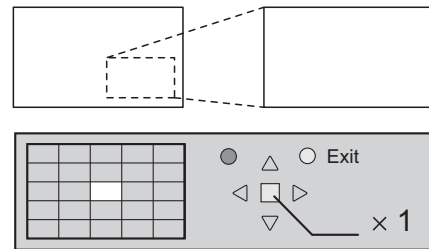

**During Digital Zoom, only the following buttons can be operated.**

[Remote control]

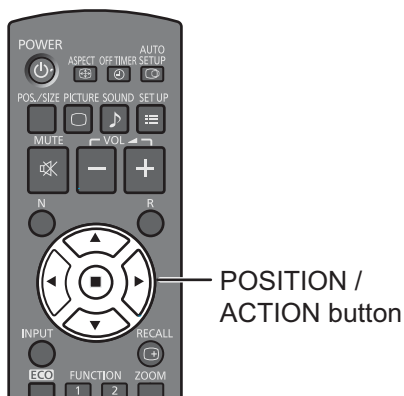

## 2 Select the area of the image to be enlarged.

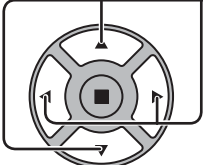
Press on the enlargement location to select.  
 The cursor will move.

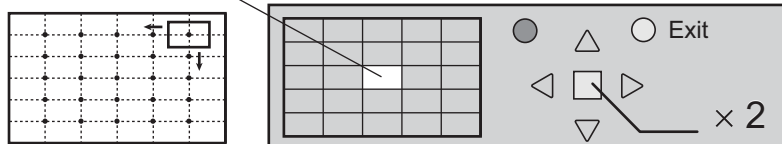

## 3 Select the magnification required for the enlarged display.

Each time this is pressed, the magnification factor changes.  
 This is shown in the image being displayed.

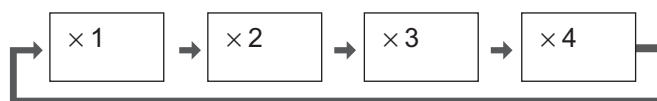

## 4 Return to normal display (quit Digital Zoom).

**R**  
 Press to exit from the Digital Zoom.

### Notes:

- When power goes OFF (including "Off Timer" operation), Digital Zoom terminates.
- The Digital Zoom function cannot be selected while in the following operation state:  
 When MULTI DISPLAY Setup is On (see page 37).  
 When Screensaver is running (see page 31)
- While Digital Zoom is in operation, "Adjusting Pos. / Size" cannot be used.

# On-Screen Menu Displays

## Remote Control

## Unit

### 1 Display the menu screen.



Press to select.  
(Example: Picture menu)



Press several times.

Each time the MENU button is pressed, the menu screen will switch.

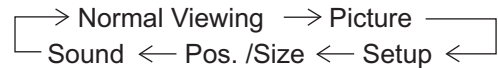

### 2 Select the item.

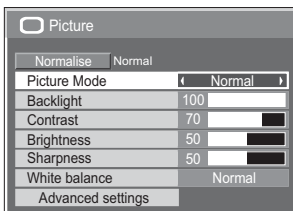

(Example: Picture menu)

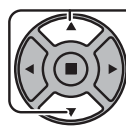

Select.

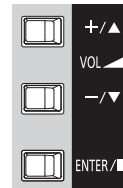

① Select.

② Press.

### 3 Set.



Adjust.

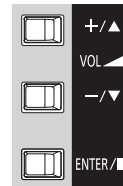

① Adjust.

② Press.

### 4 Exit the menu.



Press.  $\text{R}$   
Press  $\text{O}$  to return to the previous menu.



Press several times.

## Menu display list

**Note:** Menu that cannot be adjusted is grayout. Adjustable menu changes depending on signal, input and menu setting.

### Picture menu

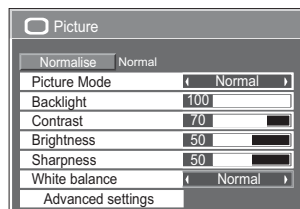

See page 26, 27

### Setup menu

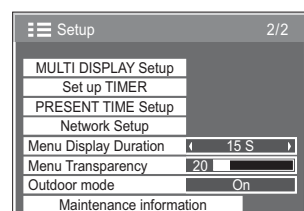
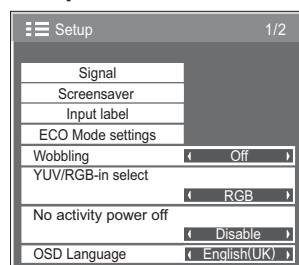

See page 29-45

### Pos./Size menu

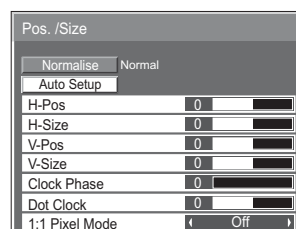

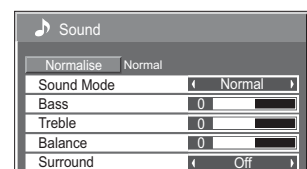

See page 24, 25

### Sound menu

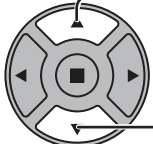
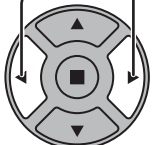

See page 28

# Adjusting Pos. /Size

- 1  Press to display the Pos. /Size menu.
- 2  Press to select the menu to adjust.
- 3  Press to adjust the menu.
- 4  Press to exit from adjust mode.

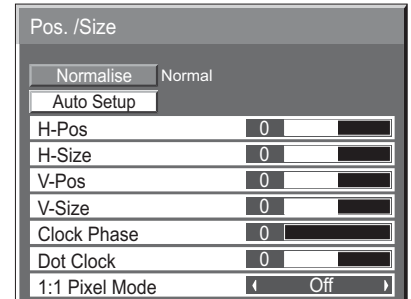

## Notes:

Unadjustable items are grayed out.

Adjustable items differ depending on the input signal and the display mode.

## Note:

If a "Cue" or "Rew" signal from a VCR or DVD player is received, the picture position will shift up or down. This picture position movement cannot be controlled by the Picture Pos./Size function.

**Auto Setup** H-Pos/V-Pos, H-Size/V-Size, Dot Clock and Clock Phase are automatically adjusted when the PC signal is received.

This setting only operates when a PC signal is input, and the aspect is "16:9".

## Using Remote Control



When  on the remote control is pressed, "Auto Setup" will be executed.

When Auto Setup does not work, "Invalid" is displayed.

## Notes:

- Auto Setup may not work when a cropped or dark image is input. In such case, switch to a bright image with borders and other objects are clearly shown, and then try auto setup again.
- Depending on the signal, out of alignment may occur after Auto Setup. Carry out fine tuning for the position/size as required.
- If Auto Setup cannot set properly for vertical frequency 60Hz XGA signal (1024×768@60Hz and 1366×768@60Hz), pre-selecting the individual signal in "XGA Mode" (see page 40) may results in correct Auto Setup.
- Auto Setup does not work well when a signal such as additional information is superimposed out of valid image period or intervals between synchronizing and image signals are short.
- If Auto Setup cannot adjust correctly, select "Normalise" once and press ACTION (■), then adjust Pos. /Size manually.
- If the picture goes off screen in the horizontal direction as a result of performing Auto Setup, perform Dot Clock adjustment.



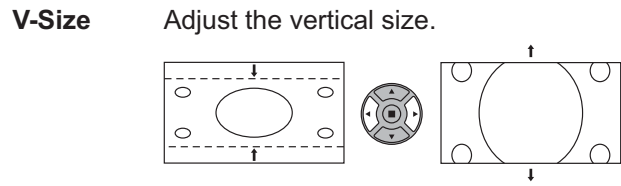
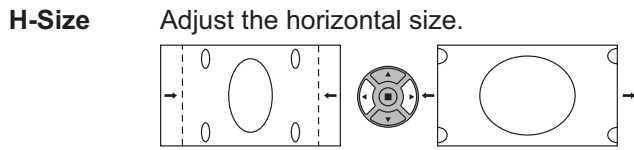
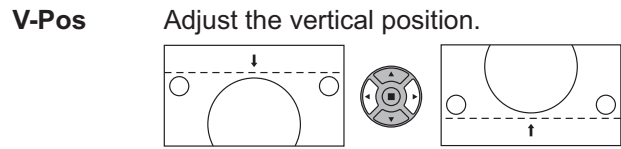
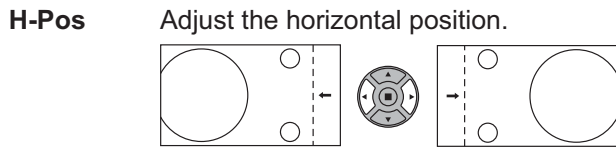

**Clock Phase** **(During PC input signal)**  
Eliminate the flickering and distortion.

**Dot Clock** **(During PC input signal)**  
Periodic striped pattern interference (noise) may occur when a striped pattern is displayed. If this happens, adjust so that any such noise is minimized.

**Over scan** Turn image over scan On/Off.  
Configurable signals are as follows:  
525i, 525p, 625i, 625p, 750/60p, 750/50p (DVI, HDMI)

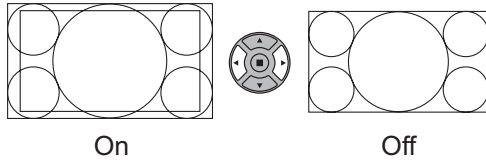

**Notes:**

- “Off” is effective during only “16:9” aspect mode.
- When “Off” is set, “H-Size” and “V-Size” cannot be adjusted.

**1:1 Pixel Mode** Adjusts the display size when 1125i or 1125p signal is input.

**Notes:**

- “On” is effective during only “16:9” aspect mode.
- Select On when you would like to replay 1920 × 1080 input signal.
- Applicable input signal;  
1125 (1080) / 50i · 60i · 24sF · 24p · 25p · 30p · 50p · 60p
- Select Off when flickering is shown around the image.
- H-Size and V-Size cannot be adjusted when On is selected.

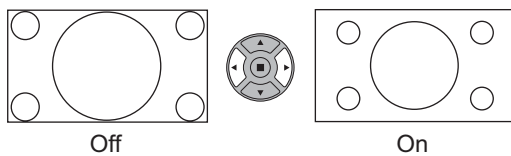

## Helpful Hint ( / Normalisation)

While the Pos. / Size display is active, if either the N button on the remote control is pressed at any time or the ACTION (■) button is pressed during “Normalise”, then all adjustment values (except “Clock Phase” and “Dot Clock”) are returned to the factory settings.

# Picture Adjustments

**1**  Press to display the Picture menu.

**2** Select to adjust each item.

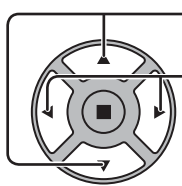
 Press to select the menu to adjust.  
 Select the desired level by looking at the picture behind the menu.

**Note:**  
 Menu that cannot be adjusted is grayout. Adjustable menu changes depending on signal, input and menu setting.

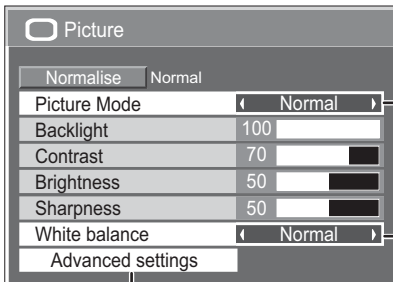

Press to enter Advanced settings .

**Advanced settings**  
 Enables fine picture adjustment at a professional level (see next page).

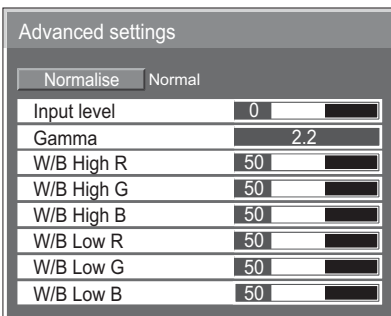

Press “◀” or “▶” button to switch between modes.



**Normal\***

For viewing in standard (evening lighting) environments.

\* In “ENGLISH (US)” OSD language, this is displayed as “STANDARD”.

**Dynamic**

For viewing in brighter environments.

**Cinema**

For use in viewing tone-focused pictures with brightness reduced.

**Note:**

If you would like to change the picture and colour of the selected Picture menu to something else, adjust using the items in the Picture menu. (see next page)

- In “ENGLISH (US)” OSD language, the “Picture Mode” is displayed as “PICTURE MENU”.









Press “◀” or “▶” button to switch between modes.



- In “ENGLISH (US)” OSD language, the “White balance” is displayed as “COLOR TEMP”.

**Helpful Hint (  /  Normalisation)**

While the “Picture” menu is displayed, if either the N button on the remote control is pressed at any time or the ACTION (  ) button is pressed during “Normalise”, then all adjustment values are returned to the factory settings.

















Item	Effect	Adjustments
<b>Backlight</b>	  Darker      Brighter	Adjusts luminance of the back light.
<b>Contrast*</b>	  Less      More	Selects the proper brightness and density for the room.
<b>Brightness</b>	  Darker      Brighter	Adjusts for easier viewing of dark pictures such as night scenes and black hair.
<b>Sharpness</b>	  Less      More	Adjusts picture sharpness.

**Notes:**

- You can change the level of each function (Backlight, Contrast, Brightness, Sharpness) for each Picture Mode.
- The setting details for normal, dynamic and cinema respectively are memorized separately for each input terminal.
- “Backlight” can be adjusted when “ECO Mode” is set to “Custom” and “Power save” to “Off”. (see page 34)

\* In “ENGLISH (US)” OSD language, this is displayed as “PICTURE”.

## Advanced settings

Item	Effect	Details
<b>Input level</b>	  Less      More	Adjustment of parts which are extremely bright and hard to see.
<b>Gamma</b>	  Down      Up	S Curve $\longleftrightarrow$ 2.0 $\longleftrightarrow$ 2.2 $\longleftrightarrow$ 2.6
<b>W/B High R</b>	  Less      More	Adjusts the white balance for light red areas.
<b>W/B High G</b>	  Less      More	Adjusts the white balance for light green areas.
<b>W/B High B</b>	  Less      More	Adjusts the white balance for light blue areas.
<b>W/B Low R</b>	  Less      More	Adjusts the white balance for dark red areas.
<b>W/B Low G</b>	  Less      More	Adjusts the white balance for dark green areas.
<b>W/B Low B</b>	  Less      More	Adjusts the white balance for dark blue areas.

**Notes:**

- Carry out “W/B” adjustment as follows.
  1. Adjust the white balance of the bright sections using the “W/B High R”, “W/B High G” and “W/B High B” settings.
  2. Adjust the white balance of the dark sections using the “W/B Low R”, “W/B Low G” and “W/B Low B” settings.
  3. Repeat steps 1 and 2 to adjust.
 Steps 1 and 2 affect each other’s settings, so repeat each step in turn to make the adjustment.
- The adjustment values are memorized separately for each input terminal.
- The adjustment range values should be used as an adjustment reference.

### Helpful Hint ( / **Normalise** **Normalisation** )

On the remote control unit, while the “Advanced settings” menu is displayed, if either the N button is pressed at any time or the ACTION (  ) button is pressed during “Normalise”, then all adjustment values are returned to the factory settings.

# Sound Adjustment

**1**  Press to display the Sound menu.

**2** Select to adjust each item.

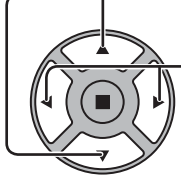
 Press to select the menu to adjust.  
Select the desired level by listening to the sound.

**3**  Press to exit from adjust mode.

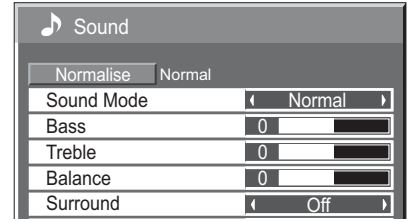

Item	Details
<b>Sound Mode*1</b>	<b>Normal*2:</b> Emits the original sound. <b>Dynamic:</b> Accentuates sharp sound. <b>Clear:</b> Attenuates human voice.
<b>Bass</b>	Adjusts low pitch sounds.
<b>Treble</b>	Adjusts high pitch sounds.
<b>Balance</b>	Adjusts left and right volumes.
<b>Surround</b>	Select On or Off.

**Note:** Bass, Treble and Surround settings are memorized separately for each Sound Mode.

\*1 In "ENGLISH (US)" OSD language, this is displayed as "AUDIO MENU".

\*2 In "ENGLISH (US)" OSD language, this is displayed as "STANDARD".

## Helpful Hint ( / **Normalise** Normalisation)

While the "Sound" menu is displayed, if either the N button on the remote control is pressed at any time or the ACTION (■) button is pressed during "Normalise", then all adjustment values are returned to the factory settings.

# PRESENT TIME Setup / Set up TIMER

The timer can switch the Display On or Off.

Before attempting Timer Set, confirm the PRESENT TIME and adjust if necessary. Then set POWER ON Time / POWER OFF Time.

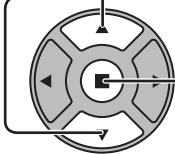
- 1  Press to display the Setup menu.
- 2  Press to select Set up TIMER or PRESENT TIME Setup.  
Press to display the Set up TIMER screen or PRESENT TIME Setup screen.

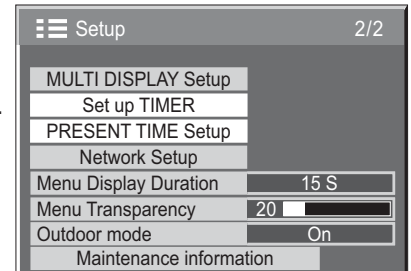

## PRESENT TIME Setup

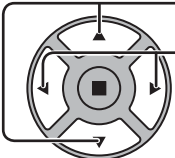
- 1  Press to select DAY or PRESENT TIME\*.  
Press to setup DAY or PRESENT TIME\*.  
▶ button: Forward  
◀ button: Back  
**Notes:**
  - Pressing “◀” or “▶” button once changes PRESENT TIME 1 minute.
  - Pressing “◀” or “▶” button continuously changes PRESENT TIME by 15 minutes.

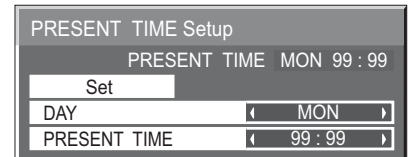

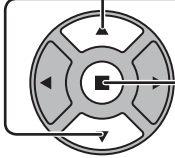
- 2  Press to select Set.  
Press to store PRESENT TIME Setup.  
**Notes:**
  - Set cannot be selected unless PRESENT TIME\* is set.
  - Unless setting the present time other than “99:99”, “DAY” and “PRESENT TIME”\* can not be set.
  - The settings of “DAY” and “PRESENT TIME”\* are reset when leaving the display turned off for about 7 days for the following reasons:
    - Pressing ⏻/| switch of the unit to turn off the display.
    - Disconnecting the AC cord.
    - Interruption of power supply.

\* In “ENGLISH (US)” OSD language, this is displayed as “PRESENT TIME OF DAY”.

## Set up TIMER

Set the program for turning the power On/Off and select the input signal at the specified time. Up to 20 programs can be set.

### [Setting Example]

Program 1, Every Monday, 12:00, Power On, Input: HDMI

Set up TIMER	
PRESENT TIME MON 0 : 03	
Program	1
Timer Function	On
Day	MON
Power Mode	Power On
Time	12 : 00
Input	HDMI

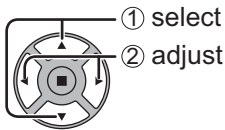

- 1 Set the program number.
- 2 To execute the program, set to "On".  
The program is disabled when "Off" is set.
- 3 Set the day.  
The program is executed every day when "Everyday" is set.
- 4 Set the power On/Off.
- 5 Set the time.  
Pressing "◀" or "▶" button once changes "Time" 1 minute.  
Pressing "◀" or "▶" button continuously changes "Time" by 15 minutes.
- 6 Set the input.

### Notes:

- This function cannot be set unless "PRESENT TIME Setup" is set.
- If more than one programs are set for the same time, only the program with the smallest program number is enabled.

# Screensaver (For preventing image retention)

Do not display a still picture, especially in 4:3 mode, for any length of time.

If the display must remain on, a Screensaver should be used.

When the screen saver is operating, the following 5 patterns are displayed full screen for 5 seconds each.

Black→Dark Gray→Gray→Light Gray→White

**1**  Press to display the Setup menu.

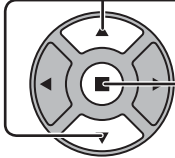
**2**  Press to select Screensaver.  
Press to display Screensaver screen.

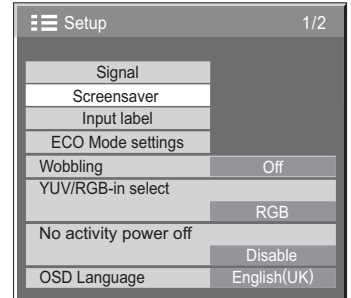

## 3 Mode selection

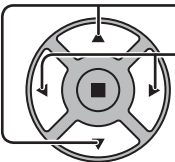
 Press to select Mode.  
Press to select each mode items.

- Off
- ↕
- Interval : Operates when Periodic Time and Operating Time are setup and those times arrive.
- ↕
- Time Designation\* : Operates when Start Time and Finish Time are setup and those times arrive.  
\* In "ENGLISH (US)" OSD language, this is displayed as "TIME OF DAY".
- ↕
- Standby after SCR Saver: Operates while Screensaver duration, and display enters standby mode.
- ↕
- On : Operates when Start is selected and the ACTION (■) button is pressed.

## 4 Start setting

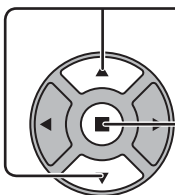
 When the Mode is set to On, press to select Start.  
Press to start Screensaver.

The menu screen will disappear and the Screensaver will be activated. **To stop the Screensaver under On, press the R button or any buttons on the main unit.**

**Note:** When the display is turned off, the Screensaver will be deactivated.

## Setup of Screensaver Time

After selecting Time Designation, Interval or Standby after SCR Saver, the relevant Time Setup will become available for selection and the Operating Time may be set. (Time cannot be set when "Mode" is "On" or "Off".)

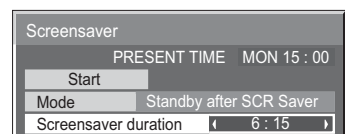
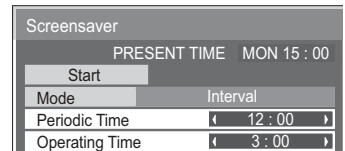
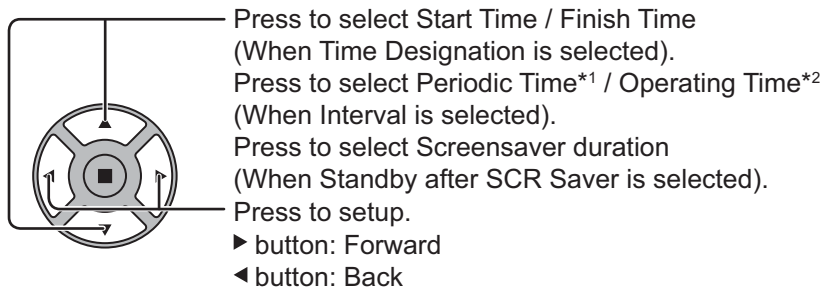

\*1 In "ENGLISH (US)" OSD language, this is displayed as "SHOW DURATION".  
\*2 In "ENGLISH (US)" OSD language, this is displayed as "SAVER DURATION".

### Notes:

- Pressing "◀" or "▶" button once changes the Time 1 minute.  
[However, switching occurs every 15 minutes when Periodic Time is selected.]
- Pressing "◀" or "▶" button continuously changes the Time by 15 minutes.
- "Screensaver duration" of the "Standby after SCR Saver" can be set from 0:00 to 23:59. When this is set to "0:00", "Standby after SCR Saver" will not be activated.

**Note:** Timer function will not work unless "PRESENT TIME" is set.

## Wobbling

Automatically shifts the display image (therefore unnoticeable to the eye) to prevent image retention of sharper contour of image.

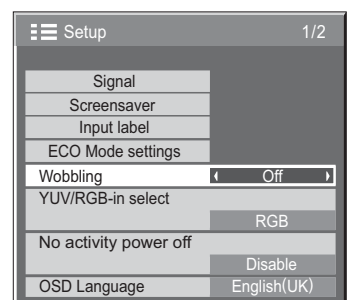
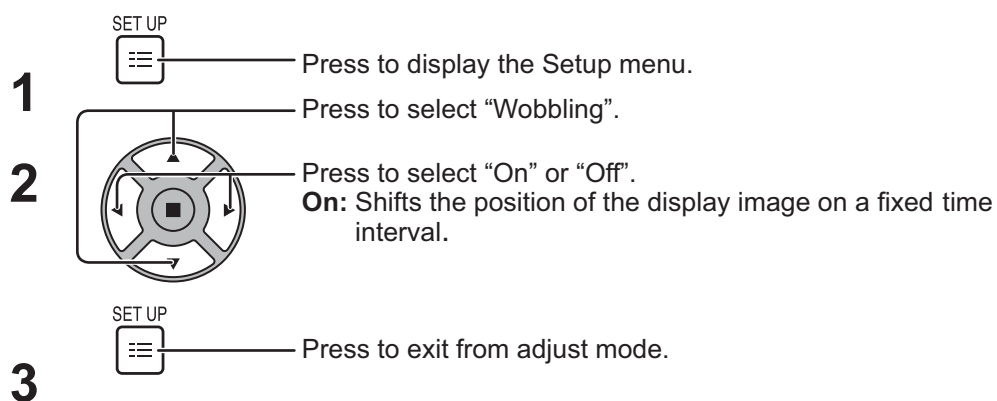

### Notes:

- If "MULTI DISPLAY Setup" is set to "On", this function does not operate.
- When this function is operating, part of the screen may appear to be missing.



# No activity power off

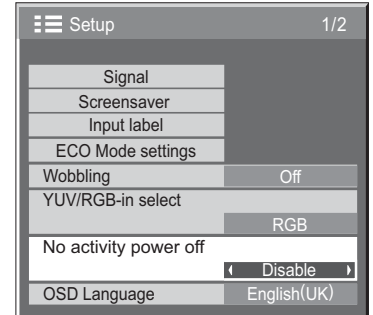
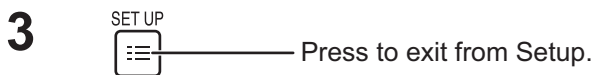
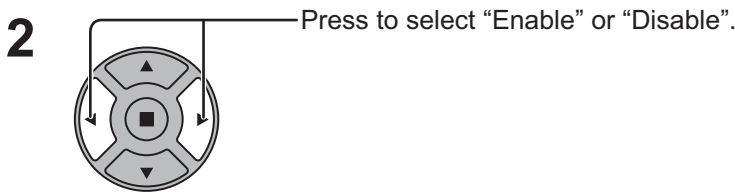
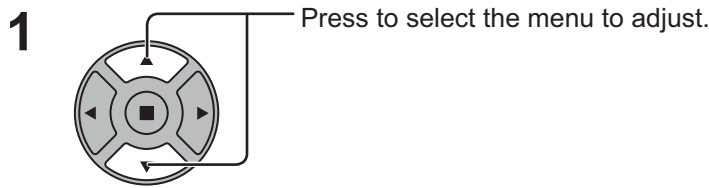

When this function is set to "Enable", the power is turned off (standby) automatically when there is no operation of the Display for 4 hours. Starting from 3 minutes before the turn off, the remaining time will be displayed.

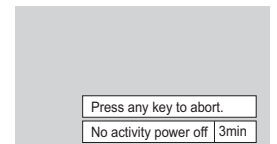

When the power is turned off due to this function, a message "Last turn off due to 'No activity power off'." is displayed next time the power is turned on.

**Note:**

During the screensaver is running, this function is disabled.

# Outdoor mode

These settings are configured to preserve the quality of the Display when it is used in a high or low temperature environment.

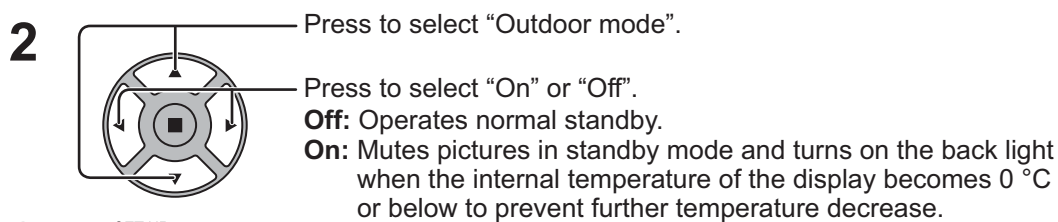
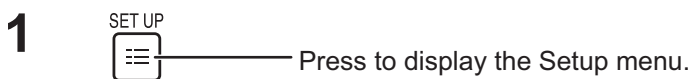

When this function is set to "On", the following message appears at standby.

OUTDOOR MODE IS ACTIVE.

**Notes:**

- Do not unplug the power cable while using the Display with this function "On".
- When this function is set to "On", the power consumption at standby is approx. 40W.
- The fans spin while this is set to "On" even if the Display is in standby mode.
- Turn this function "On" to use this product when it is directly exposed to sunlight.

# ECO Mode settings

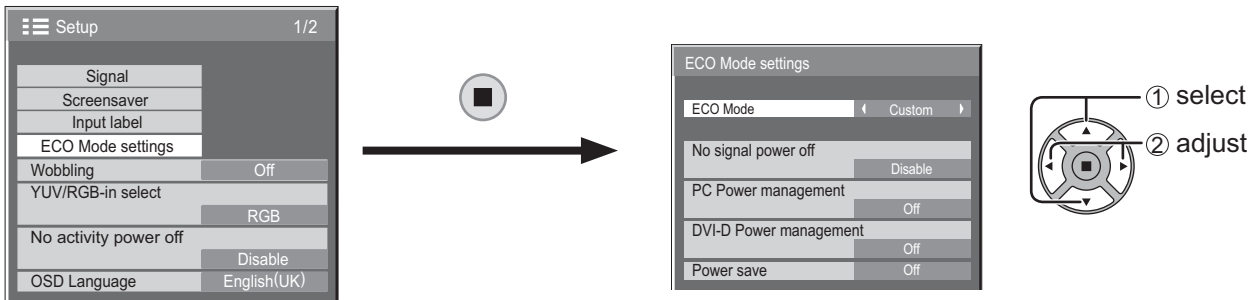

## ECO Mode

**Custom:** The menu of power consumption reduction is individually set.

**On:** The following fixed values are set to the menu of power consumption reduction. Individual setting is not available.

No Signal power off: Enable  
PC Power management: On  
DVI-D Power management: On  
Power save: Sensor

### Using Remote Control

When **ECO** is pressed, the "ECO Mode" setting changes.

ECO Mode On

## Custom settings

The menu of the power consumption reduction is individually set. This setting is enabled when "ECO Mode" is set to "Custom".

### No signal power off

Equipment power supply is turned Off when there is no signal.

When this is set to "Enable", the power supply of the unit goes Off 10 minutes after the input signals stop.

### PC Power management

When this function is set to On, it operates under the following conditions to turn the power on or off automatically.

When no pictures are detected for 30 or so seconds during PC signal input:

→ Power is turned off (standby); the power indicator lights up orange.

When pictures are subsequently detected:

→ Power is turned on; the power indicator lights up green.

### Notes:

- This function operates only during input from PC IN terminal.
- This function is effective when "Sync" is set to "Auto" and during normal viewing.

### DVI-D Power management

When this function is set to On, it operates under the following conditions to turn the power on or off automatically.

When no pictures (sync signal) are detected for 30 or so seconds during DVI signal input:

→ Power is turned off (standby); the power indicator lights up orange.

When pictures (sync signal) are subsequently detected:

→ Power is turned on; the power indicator lights up green.

### Note:

This function operates only during DVI signal input.

### Power save

This function adjusts the brightness of the backlight to reduce power consumption.

**Off:** This function does not operate.

**On:** Backlight brightness is reduced.



**Sensor:** The backlight brightness is automatically adjusted according to the viewing environment.

### Note:

When this function is set to "On" or "Sensor", the "Backlight" setting in the Picture menu is disabled.

# Customizing the Input labels

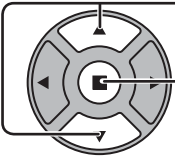
This function can change the label of the Input signal to be displayed. (see page 18)

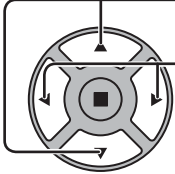
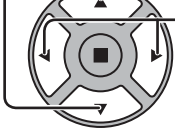
- 1  Press to display the Setup menu.
- 2  Press to select Input label.  
 Press to display the Input label screen.
- 3  Press to select image input.  
 Press to change input label.

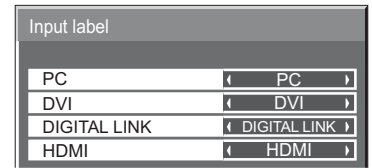
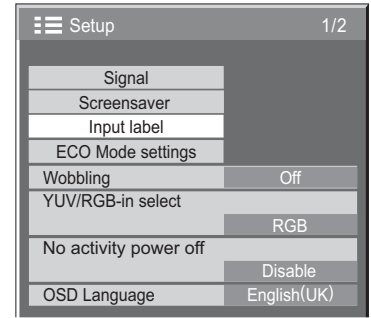

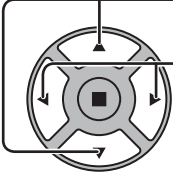
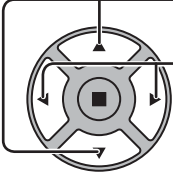

Image input  
 [PC]  
 [DVI]  
 [DIGITAL LINK]  
 [HDMI]

Input label  
 PC / DVD1 / DVD2 / DVD3 / Blu-ray1 / Blu-ray2 / Blu-ray3 / CATV / VCR / STB / (Skip)  
 DVI / DVD1 / DVD2 / DVD3 / Blu-ray1 / Blu-ray2 / Blu-ray3 / CATV / VCR / STB / (Skip)  
 DIGITAL LINK / DVD1 / DVD2 / DVD3 / Blu-ray1 / Blu-ray2 / Blu-ray3 / CATV / VCR / STB / (Skip)  
 HDMI / DVD1 / DVD2 / DVD3 / Blu-ray1 / Blu-ray2 / Blu-ray3 / CATV / VCR / STB / (Skip)

(Skip): The INPUT button press will skip its input.

# Selecting the On-Screen Menu Language

-  Press to display the Setup menu.
-  Press to select the OSD Language.  
 Press to select your preferred language.

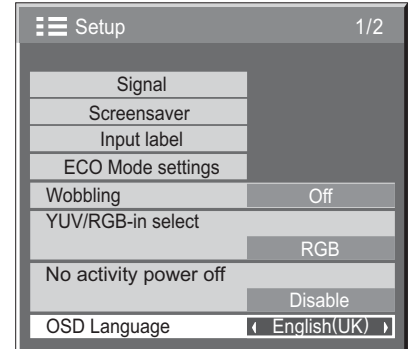

## ■ Selectable languages

- English (UK)
- ↕
- Deutsch
- ↕
- Français
- ↕
- Italiano
- ↕
- Español
- ↕
- ENGLISH (US)
- ↕
- 中文.....(Chinese)
- ↕
- 日本語.....(Japanese)
- ↕
- Русский.....(Russian)

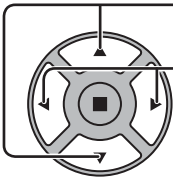
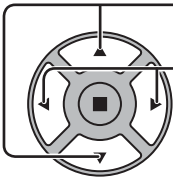
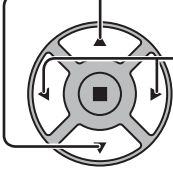
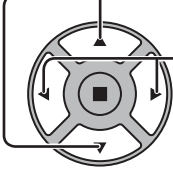

# Customizing the On-Screen Menu Display

Set the display time and background transparency of the on-screen menu display.

-  Press to display the Setup menu.
-  Press to select "Menu Display Duration".  
 Press to adjust the display duration.
-  Press to select "Menu Transparency".  
 Press to adjust the transparency.
-  Press to exit from adjust mode.

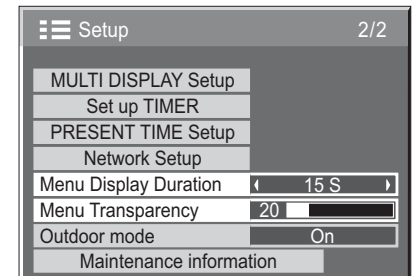

# Setup for MULTI DISPLAY

By lining up the Displays in groups, for example, as illustrated below, an enlarged picture may be displayed across all screens.

For this mode of operation, each display has to be set up with a Display number to determine its location.

(Example)

group of 4 (2 × 2)



group of 9 (3 × 3)



group of 16 (4 × 4)





group of 25 (5 × 5)

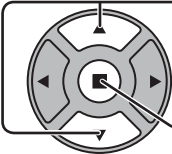
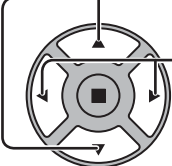

## How to Setup MULTI DISPLAY

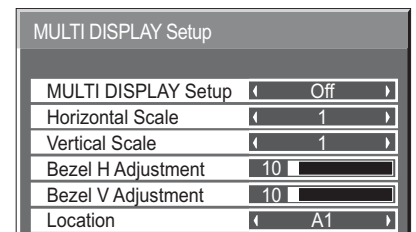
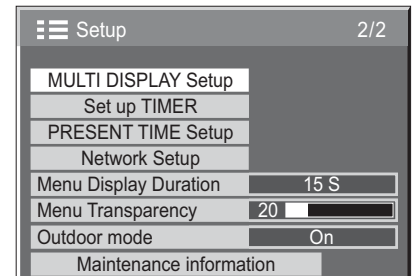
- 1  Press to display the Setup menu.
- 2  Press to select the MULTI DISPLAY Setup.  
Press to display the "MULTI DISPLAY Setup" menu.
- 3  Press to select the MULTI DISPLAY Setup.  
Press to select "On" or "Off".



Item	Details
<b>MULTI DISPLAY Setup</b>	Select "On" or "Off".
<b>Horizontal Scale</b>	Select "1", "2", "3", "4", "5".
<b>Vertical Scale</b>	Select "1", "2", "3", "4", "5".
<b>Bezel H Adjustment Bezel V Adjustment</b>	<p>Areas of the image that are hidden by the joint sections are adjusted both horizontally and vertically (0~100).</p> <div style="display: flex; justify-content: space-around;"> <div style="text-align: center;"> <p>To show joints between displays.</p>  <p><b>Example</b></p> <p>Suitable for still image display. Setting value: 0</p> </div> <div style="text-align: center;"> <p>To hide joints between displays.</p>  <p><b>Example</b></p> <p>Suitable for moving image display. Setting value: 100</p> </div> </div>

# Setup for MULTI DISPLAY

Item	Details																																																									
	Select the required arrangement number. (A1-E5 : Refer to the following) <b>Display Number locations for each arrangement.</b> <b>(Examples)</b>																																																									
<b>Location</b>	<div style="display: flex; justify-content: space-around; align-items: flex-start;"> <div style="text-align: center;"> <p>( 2 × 1 )</p> <table border="1" style="margin: 0 auto;"> <tr><td>A1</td><td>A2</td></tr> </table> </div> <div style="text-align: center;"> <p>( 2 × 3 )</p> <table border="1" style="margin: 0 auto;"> <tr><td>A1</td><td>A2</td></tr> <tr><td>B1</td><td>B2</td></tr> <tr><td>C1</td><td>C2</td></tr> </table> </div> <div style="text-align: center;"> <p>( 4 × 2 )</p> <table border="1" style="margin: 0 auto;"> <tr><td>A1</td><td>A2</td><td>A3</td><td>A4</td></tr> <tr><td>B1</td><td>B2</td><td>B3</td><td>B4</td></tr> </table> </div> <div style="text-align: center;"> <p>( 4 × 4 )</p> <table border="1" style="margin: 0 auto;"> <tr><td>A1</td><td>A2</td><td>A3</td><td>A4</td></tr> <tr><td>B1</td><td>B2</td><td>B3</td><td>B4</td></tr> <tr><td>C1</td><td>C2</td><td>C3</td><td>C4</td></tr> <tr><td>D1</td><td>D2</td><td>D3</td><td>D4</td></tr> </table> </div> <div style="text-align: center;"> <p>( 5 × 5 )</p> <table border="1" style="margin: 0 auto;"> <tr><td>A1</td><td>A2</td><td>A3</td><td>A4</td><td>A5</td></tr> <tr><td>B1</td><td>B2</td><td>B3</td><td>B4</td><td>B5</td></tr> <tr><td>C1</td><td>C2</td><td>C3</td><td>C4</td><td>C5</td></tr> <tr><td>D1</td><td>D2</td><td>D3</td><td>D4</td><td>D5</td></tr> <tr><td>E1</td><td>E2</td><td>E3</td><td>E4</td><td>E5</td></tr> </table> </div> </div>	A1	A2	A1	A2	B1	B2	C1	C2	A1	A2	A3	A4	B1	B2	B3	B4	A1	A2	A3	A4	B1	B2	B3	B4	C1	C2	C3	C4	D1	D2	D3	D4	A1	A2	A3	A4	A5	B1	B2	B3	B4	B5	C1	C2	C3	C4	C5	D1	D2	D3	D4	D5	E1	E2	E3	E4	E5
A1	A2																																																									
A1	A2																																																									
B1	B2																																																									
C1	C2																																																									
A1	A2	A3	A4																																																							
B1	B2	B3	B4																																																							
A1	A2	A3	A4																																																							
B1	B2	B3	B4																																																							
C1	C2	C3	C4																																																							
D1	D2	D3	D4																																																							
A1	A2	A3	A4	A5																																																						
B1	B2	B3	B4	B5																																																						
C1	C2	C3	C4	C5																																																						
D1	D2	D3	D4	D5																																																						
E1	E2	E3	E4	E5																																																						

- 4**  Press to exit from Setup.

## ID Remote Control Function









You can set the remote control ID when you want to use this remote control on one of several different displays.

### Note:

To operate this function, please purchase ID remote controller sold separately.

Object model : EUR7636090R (Europe)

EUR7636070R (Other countries)

- 1** Switch  to  on the right side.
- 2** Press the  button on the remote control.
- 3** Press one of  - ,  for the tens digit setting.
- 4** Press one of  - ,  for the units digit setting.

### Notes:

- The numbers in 2, 3 and 4 should be set up quickly.
- Adjustable ID number range is 0 - 99.
- If a number button is pressed more than two times, the first two numbers become the ID number for the remote control.

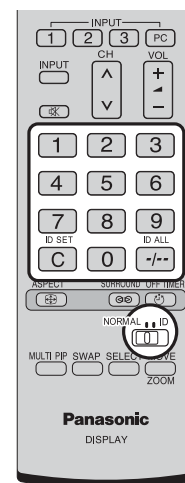

### ID remote control button operation

The operation is the same as normal remote control except for the  button.

### ID Cancellation

Press  button on remote control. (This has the same effect as pressing the , ,  buttons at the same time.)

### Notes:

- Set the Remote ID "On" to operate the ID remote control.  
If Remote ID is set to "On", you can use the remote control without identical ID number during option menu display. (see page 47)
- The ID remote control cannot be used when ID select is set to anything other than 0, and the remote control ID is not the same as the ID select number (see page 47).

# Setup for Input Signals

## YUV / RGB-in select

Select to match the signals from the source connected to DVI-D IN terminal.

YUV signals ⇔ "YUV"

RGB signals ⇔ "RGB"

**1**  Press to display the Setup menu.

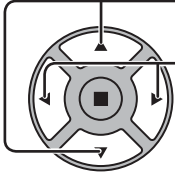
**2**  Press to select the "YUV / RGB-in select".  
Press to select the desired mode.  
YUV ← → RGB

**3**  Press to exit from adjust mode.

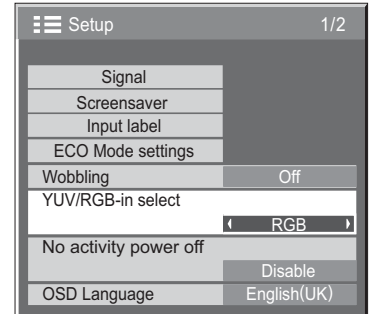

## Signal menu

### Note:

"Signal" setup menu displays a different setting condition for each input signal.

**1**  Press to display the Setup menu.

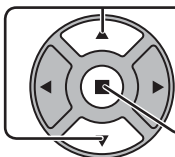
**2**  Press to select the "Signal".  
Press to display the Signal menu.

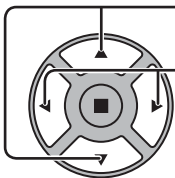
**3**  Press to select the menu to adjust.  
Press to adjust the menu.

**4**  Press to exit from adjust mode.

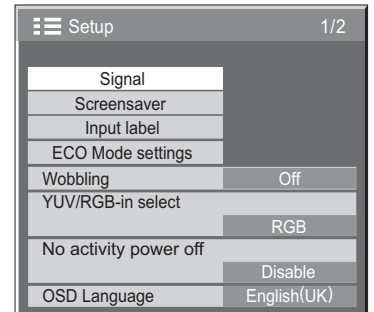

For Digital

Signal [ Digital ]	
Cinema reality	Off
HDMI Range	Auto
H-Freq.	63.98 kHz
V-Freq.	60.02 Hz
Dot Clock Freq.	108.0 MHz
Signal Format	1280×1024/60

↓ Press ACTION (■) button  
For PC

Signal [ RGB ]	
Sync	Auto
Cinema reality	Off
XGA Mode	1024×768
H-Freq.	63.98 kHz
V-Freq.	60.02 Hz
Signal Format	1280×1024/60

### Cinema reality\*

#### Cinema reality\*:

When on, the display attempts to reproduce a more natural interpretation of sources such as movie pictures, which are recorded at 24 frames per second. If the picture is not stable, turn the setting to off.

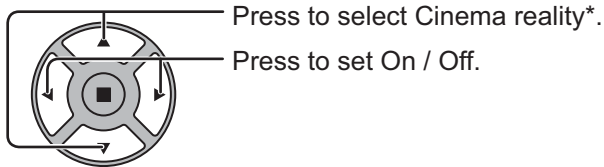

\* In "ENGLISH (US)" OSD language, this is displayed as "3:2 PULLDOWN".

### XGA Mode

This menu is displayed when the input signal is analog. This menu sets two types of XGA signals with 60Hz vertical frequency having different aspect ratios and sampling rates (1,024 × 768 @ 60Hz and 1,366 × 768 @ 60Hz). When a 1,280 × 768 @ 60Hz input signal is automatically detected, the image is processed as a 1,280 × 768 @ 60Hz XGA input signal irrespective of this setting.

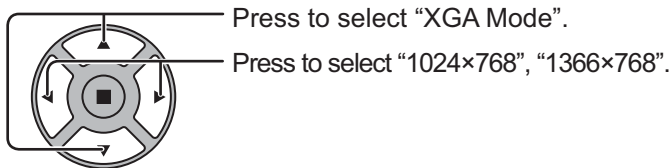

#### Note:

After making this setting, be sure to make each adjustment (such as "Auto Setup") on the "Pos. /Size" menu as necessary. (see page 24, 25)

### Sync

This function operates only during input from PC IN terminal.

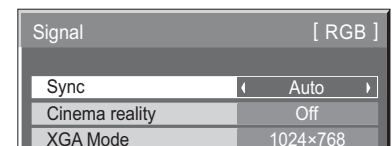
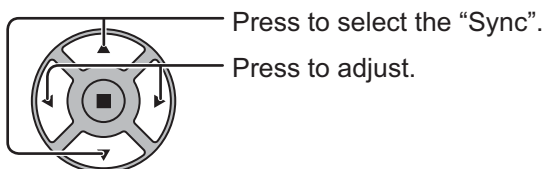

Confirm that the input is set to RGB input (this setting is valid only for RGB input signal).

Auto: The H and V sync or synchronized signal is automatically selected. If both input, it is selected the H and V sync. However, the synchronized signal that is input first is selected.



on G: Uses a synchronized signal on the Video G signal, which is input from the G connector.



## HDMI Range

Switches the dynamic range according to the input signal from HDMI terminal.

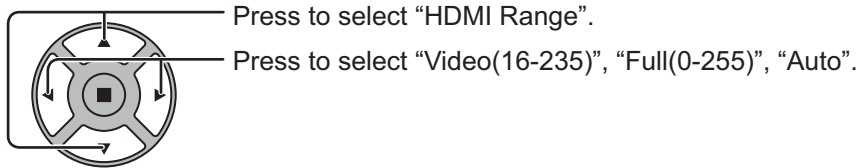

Signal [ Digital ]	
Cinema reality	Off
HDMI Range	Auto

**Video(16-235):** If the input signal is the video range, Example: HDMI terminal output for DVD player

**Full(0-255):** If the input signal is full range, Example: HDMI terminal output for personal computer

**Auto:** Switches the dynamic range automatically between "Video(16-235)" and "Full(0-255)" according to the input signal.

**Note:**

This function can be set to the HDMI signal and DIGITAL LINK.

## Input signal display

Displays the frequency and the type of the current input signal.

This display is valid only for PC and Digital input signal.

Display range:

Horizontal 30 - 110 kHz

Vertical 48 - 120 Hz

H-Freq.	63.98	kHz
V-Freq.	60.02	Hz
Signal Format	1280×1024/60	

The dot clock frequency is displayed during digital signal input.

H-Freq.	63.98	kHz
V-Freq.	60.02	Hz
Dot Clock Freq.	108.0	MHz
Signal Format	1280×1024/60	

**Note:**

The automatically detected signal format may be displayed differently than the actual input signal.

# Maintenance information

Maintenance information related to the fan and air filter is displayed.

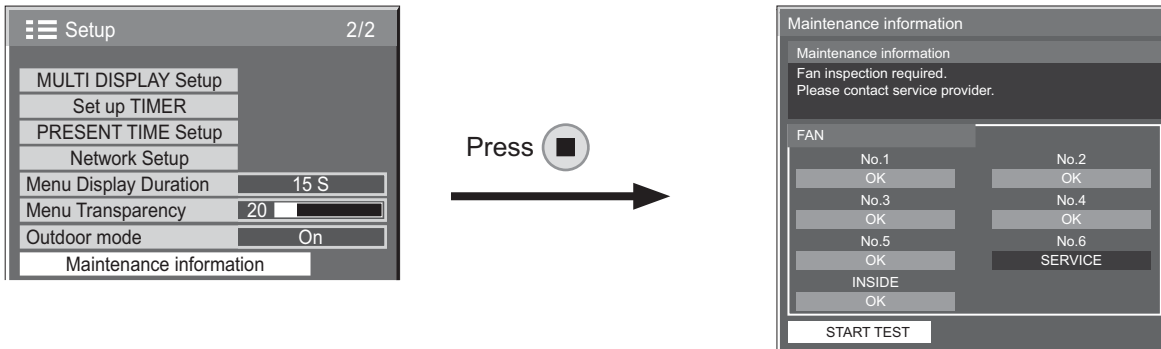

## ■ Maintenance information

Messages related to the air filter condition, fan operating status and inspection notifications are displayed.

When "Please clean filters. Then, click "START TEST". Consult owner's manual for instructions." is displayed, remove and clean the air filter. (see page 5)

If "Please clean filters. Then, click "START TEST". Consult owner's manual for instructions." is displayed again a short period after cleaning the air filter, contact the service provider.

If "Please contact service provider." is displayed, contact the service provider.

- After cleaning the air filter, press  to execute the status test again and check the maintenance information.

## ■ FAN

The status of each fan is displayed.

If "SERVICE" is displayed, contact the service provider for inspection of the fan.

### Note:

When viewed from the back, the fans are displayed as "No.1" to "No.6" in order starting from the right side. Interior circulation fans inside the Display are indicated as "INSIDE".

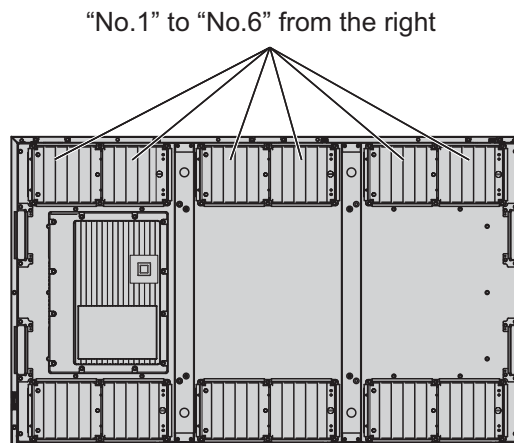

# Network Setup

Configure the various settings required to use the network function.

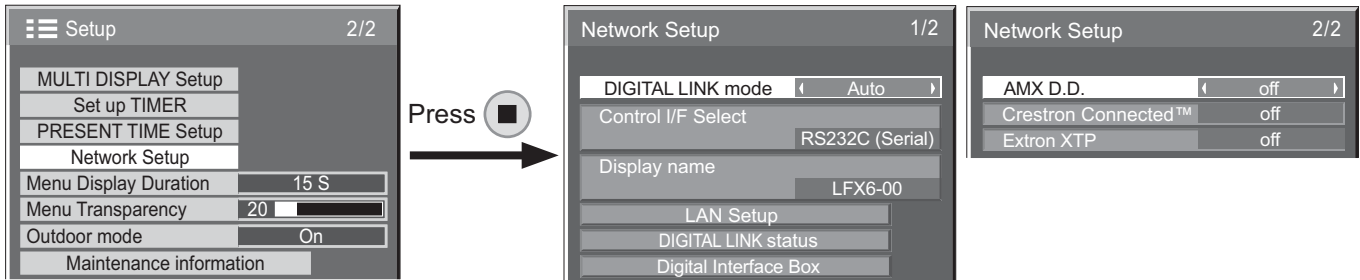

## ■ DIGITAL LINK mode

You can switch the communication method of DIGITAL LINK.

Auto: The communication method is automatically selected. HDMI/LAN/RS232C communication can be used. Ethernet connection can be made.

DIGITAL LINK: HDMI/LAN/RS232C communication can be used via a twisted pair cable transmitter.

Ethernet: LAN communication can be used via the LAN terminal of the Display.

### Note:

When "Ethernet" is selected, set the "Control I/F Select" to "LAN".

## ■ Control I/F Select

RS232C (Serial): Control using the Display's RS232C.

LAN: Control using the Display or the LAN terminal of a twisted pair cable transmitter.

RS232C(DIGITAL LINK): Control using the twisted pair cable transmitter's RS232C.

### Notes:

- When "LAN" or "RS232C(DIGITAL LINK)" is set, the power lamp lights orange when the remote control power is switched "Off" (standby).
- When controlling using the RS232C command from page 14 to the RS232C terminal of the Display, select "RS232C(DIGITAL LINK)" to control from the RS232C terminal of the "RS-232C (Serial)" or DIGITAL LINK device.
- When using any of the control techniques listed on pages 51 to 56, select "LAN".

## ■ Display Name

The name of the Display that is shown on the network can be changed.

## ■ LAN Setup

See page 44

## ■ DIGITAL LINK status

See page 45

## ■ Digital Interface Box

See page 45

## ■ AMX D.D.

This function allows the Display to be detected by AMX Device Discovery. For more details, visit the following website.

<http://www.amx.com/>

## ■ Crestron Connected™

When this function is set to on, the Display can be monitored or controlled via the network using equipment and application software of Crestron Electronics, Inc.

This Display supports the following application software from Crestron Electronics, Inc.

- RoomView® Express
- Fusion RV®
- RoomView® Server Edition

[Crestron Connected™] is a function to connect to a system developed by Crestron Electronics, Inc. which manages and controls multiple system devices connected to the network.

- For details of "Crestron Connected™", refer to the Crestron Electronics, Inc. website (Provided only in English).  
<http://www.crestron.com/>  
For the download of "RoomView® Express", refer to the Crestron Electronics, Inc. website (Provided only in English).  
<http://www.crestron.com/getroomview>

## ■ Extron XTP

To carry out connection settings with XTP Transmitter made by Extron. Visit the following website for details.  
<http://www.extron.com>

# Network Setup

## LAN Setup

Detailed network settings for the LAN established via the LAN terminal of the Display or twisted pair cable transmitter can be configured.

Select "LAN Setup" and press .

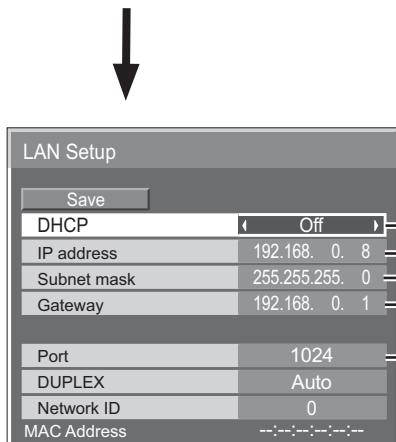



### DHCP, IP address, Subnet mask, and Gateway settings

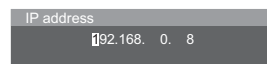

**1** Set DHCP.  
When "Off" is selected, IP address and other settings can be set manually.

**2** Select the item and press .

**3** Enter an address.



① Use   to select a digit.

② Use   to change a number.

③ Press .

Pressing  will cancel the address change.

**4** Select "Save" and press .



### Port setting

**1** Select "Port" and press .

**2** Enter a port number.



① Use   to select a digit.

② Use   to change a number.

③ Press .

Pressing  will cancel the port number change.

### Save

Save the current network Setup. Each value set for DHCP, IP address, Subnet mask, and Gateway will be saved. If "NG" is displayed, check the same IP address is not used within the same network.

### DHCP (DHCP client function)

To obtain an IP address automatically using a DHCP server, set this to "On". If DHCP server is not used, set this to "Off".

### IP address (IP address display and setting)

Enter an IP address if DHCP server is not used.

### Subnet mask (Subnet mask display and setting)

Enter a subnet mask if DHCP server is not used.

### Gateway (Gateway address display and setting)

Enter a gateway address if DHCP server is not used.

### Port

Set the port number used for command control.

The available setting range is 1024 – 65535.

When the PLink™ protocol is used, the port setting is not necessary.

### DUPLEX

Set the connection speed of the LAN environment.

Select the value from Auto, 100 Half or 100 Full.

### Network ID

Set the ID to identify this unit.

The available setting range is 0 – 99.

### MAC Address

Display the MAC address of this unit. However, the MAC address is not displayed when the "Control I/F Select" is set to "RS-232C (Serial)" or "RS-232C (DIGITAL LINK)".

### Notes:

- To use a DHCP server, make sure the DHCP server is started.
- Contact your network administrator for details on settings.

## ■ DIGITAL LINK status

Display the DIGITAL LINK connection environment.

Select "DIGITAL LINK status" and press .

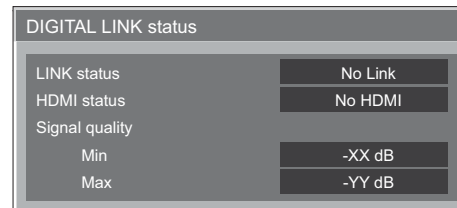

**LINK status** : Either "No link", "DIGITAL LINK", or "Ethernet" will be displayed.

No link : No LAN connection, etc.

DIGITAL LINK : Connected to the DIGITAL LINK device by LAN

Ethernet : The PC is connected to the DIGITAL LINK terminal of this product and is LAN connected

**HDMI status** : Either "No HDMI", "HDMI ON", or "HDCP ON" will be displayed.

No HDMI : DIGITAL LINK not connected

HDMI ON : DIGITAL LINK connected

HDCP ON : A signal with an HDCP is flowing with a DIGITAL LINK connection.

**Signal quality** : It is the quantified minimum and maximum numbers of errors that have occurred. The display colors are red, yellow, or green, depending on the number.

The number is represented by yellow or red if the LAN cable is disconnected or the cable is not shielded. This signal quality shows figures between the twisted pair cable transmitter that is connected and the display.

Signal Quality	Display Colors	Reception Status
-12dB or below	Green	The reception is normal
-11 to -8dB	Yellow	Part of the received data is corrupted
-7dB or above	Red	There are reception difficulties

## ■ Digital Interface Box

A switch will be made to the Set up Digital Interface Box menu when "Digital Interface Box" is selected and  is pressed.

### Note:

This function can only be selected when the Digital Interface Box (ET-YFB100) made by our company is connected to a LAN terminal and its power is on.

# Options Adjustments

**1**  Press to display the Setup menu.

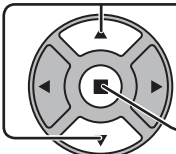
**2**  Press to select "OSD Language".  
Press for more than 3 seconds.

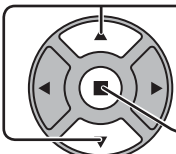
**3**  Press to select "Options".  
Press to display the Options menu.

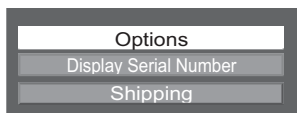

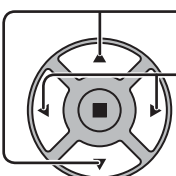



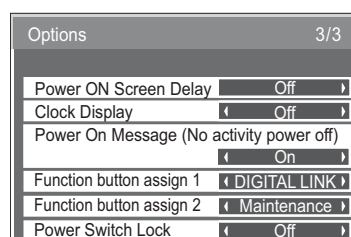
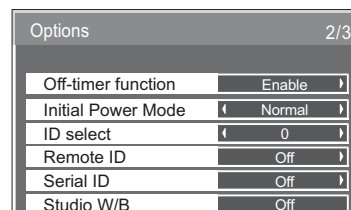
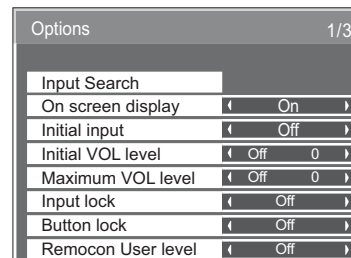

























**4**  Press to select your preferred menu.  
Press to adjust the menu.

**5**  Press to exit from Options menu.



• The serial number of this device is displayed when "Display Serial Number" is selected in step 3.

Item	Adjustments
<b>Input Search</b>	Set auto input switching for when there is no signal. (see page 48)
<b>On screen display</b>	<p><b>On:</b> Displays all the following on screen.</p> <ul style="list-style-type: none"> <li>• Power on display</li> <li>• Input signal switch display</li> <li>• No signal display</li> <li>• Mute and the remaining time of off-timer after  was pressed.</li> </ul> <p><b>Off:</b> Hides all the items above from view.</p>
<b>Initial input</b>	<p>Adjusts the input signal when the unit is turned on.</p> <p><b>Off</b> ↔ <b>PC</b> ↔ <b>DVI</b> ↔ <b>HDMI</b> ↔ <b>DIGITAL LINK</b> ↔ <b>Off</b></p> <p><b>Notes:</b></p> <ul style="list-style-type: none"> <li>• Only the adjusted signal is displayed. (see page 18)</li> <li>• This menu is available only when "Input lock" is "Off".</li> </ul>
<b>Initial VOL level</b>	<p>Press   button to adjust the volume when the unit is turned on.</p> <p><b>Off</b> ↔ <b>On</b></p> <p><b>Off:</b> Sets normal volume.</p> <p><b>On:</b> Sets your preferred volume.</p> <p><b>Notes:</b></p> <ul style="list-style-type: none"> <li>• When "Maximum VOL level" is "On", the volume can only be adjusted between 0 and your maximum range.</li> <li>• You can hear the changed volume regardless of your volume setting before opening the options menu if you adjust the volume when "Initial VOL level" is "On" and cursor is on the menu.</li> </ul>
<b>Maximum VOL level</b>	<p>Press   button to adjust the maximum volume.</p> <p><b>Off</b> ↔ <b>On</b></p> <p><b>Off:</b> Sets auto maximum volume.</p> <p><b>On:</b> Sets your preferred maximum volume.</p> <p><b>Notes:</b></p> <ul style="list-style-type: none"> <li>• If the "Maximum VOL level" is set lower than the "Initial VOL level", the "Initial VOL level" automatically becomes the same as the "Maximum VOL level".</li> <li>• The volume display can go up to 100 regardless of the settings.</li> <li>• You can hear the changed volume regardless of your volume setting before opening the options menu if you adjust the volume when "Maximum VOL level" is "On" and cursor is on the menu.</li> </ul>
<b>Input lock</b>	<p>Locks the input switch operation.</p> <p><b>Off</b> ↔ <b>PC</b> ↔ <b>DVI</b> ↔ <b>HDMI</b> ↔ <b>DIGITAL LINK</b> ↔ <b>Off</b></p> <p><b>Notes:</b></p> <ul style="list-style-type: none"> <li>• Only the adjusted signal is displayed (see page 18).</li> <li>• Input switch can be used when this is set to "Off".</li> </ul>

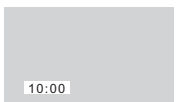

Item	Adjustments
<b>Button lock</b>	<p><b>Off</b> ↔ <b>On</b> ↔ <b>MENU&amp;ENTER</b></p> <p><b>Off:</b> All the buttons on main unit can be used.</p> <p><b>MENU&amp;ENTER:</b> Locks  MENU and  ENTER buttons on main unit.</p> <p><b>On:</b> Locks all the button on main unit except the Power switch.</p> <p>Sets Button lock with the unit buttons in the following procedure.</p> <p><b>Off:</b> Press  + / ▲ four times → Press  four times → Press  - / ▼ four times → Press  ENTER/</p> <p><b>MENU&amp;ENTER:</b> Press  ENTER/ four times → Press  + / ▲ four times → Press  four times → Press  ENTER/</p> <p><b>On:</b> Press  - / ▼ four times → Press  ENTER/ four times → Press  + / ▲ four times → Press  ENTER/</p>
<b>Remocon User level</b>	<p><b>Off</b> ↔ <b>User1</b> ↔ <b>User2</b> ↔ <b>User3</b></p> <p><b>Off:</b> You can use all of the buttons on the remote control.</p> <p><b>User1:</b> You can only use  POWER,  INPUT,  RECALL,  MUTE,  VOL-,  VOL+ buttons on the remote control.</p> <p><b>User2:</b> You can only use  POWER button on the remote control.</p> <p><b>User3:</b> Locks all the buttons on remote control.</p>
<b>Off-timer function</b>	<p><b>Enable:</b> Enables the “Off-timer function”.</p> <p><b>Disable:</b> Disables the “Off-timer function”.</p> <p><b>Note:</b> When “Disable” is set, the Off-timer is cancelled.</p>
<b>Initial Power Mode</b>	<p><b>Normal</b> ↔ <b>On</b> ↔ <b>Standby</b></p> <p>Sets the power mode of the unit for when the power recovers from failure or after plugging off and in again.</p> <p><b>Normal:</b> Power returns in as the same state as before the power interruption.</p> <p><b>Standby:</b> Power returns in standby mode. (Power Indicator : red/orange)</p> <p><b>On:</b> Power returns in power On. (Power Indicator : green)</p> <p><b>Note:</b> When using multiple displays, “Standby” is preferred to be set in order to reduce a power load.</p>
<b>ID select</b>	<p>Sets panel ID number when panel is used in “Remote ID” or “Serial ID”.</p> <p>Set value range: 0 - 100</p> <p>(Standard value: 0)</p>
<b>Remote ID</b>	<p>The setting of this menu is valid only when using ID remote control.</p> <p><b>Off:</b> Disables ID remote control functions. You can use normal remote control operations.</p> <p><b>On:</b> Enable ID remote control functions.</p> <p><b>Note:</b> To use the ID remote control function, it is necessary to set each ID number of remote control and display unit. About the setting method, please refer to “ID Remote Control Function” (see page 38) and “ID select” (above-mentioned).</p>
<b>Serial ID</b>	<p>Sets the panel ID Control.</p> <p><b>Off:</b> Disables external control by the ID.</p> <p><b>On:</b> Enables the external control by the ID.</p>
<b>Studio W/B</b>	<p><b>Off:</b> Nullify all the settings adjusted.</p> <p><b>On:</b> Sets the colour temperature for TV studio.</p> <p><b>Note:</b> Valid only when the “Warm” is set as “White balance” in Picture menu.</p>
<b>Power ON Screen Delay</b>	<p><b>Off</b> ↔ <b>1</b> ↔ <b>2</b> ↔ <b>3...</b> ↔ <b>30</b></p> <p>You can set the power-on delay time of the displays to reduce the power load, when you press  /   to turn on the multiple displays that are set together, for example, on MULTI DISPLAY system.</p> <p>Set each display's setting individually.</p> <p><b>Off:</b> The display will be turned on at the same time as  /   is pressed.</p> <p><b>1 to 30 (sec.):</b> Set the power-on delay time (second).</p> <p>After pressing  /  , the display will be powered on with time delay depending on this setting.</p> <p><b>Notes:</b></p> <ul style="list-style-type: none"> <li>• During this function is working, the power indicator is blinking green.</li> <li>• This function also works when the power recovers from failure or after plugging off and in again the power cord.</li> </ul>
<b>Clock Display</b>	<p><b>Off:</b> Not display the clock.</p> <p><b>On:</b> Display the clock.</p> <p>The clock is displayed at the lower left of the screen when  button is pressed.</p> <div style="text-align: center;">  </div> <p><b>Note:</b> When “PRESENT TIME Setup” is not set, the clock is not displayed even if “Clock Display” is “On”. (see page 29)</p>

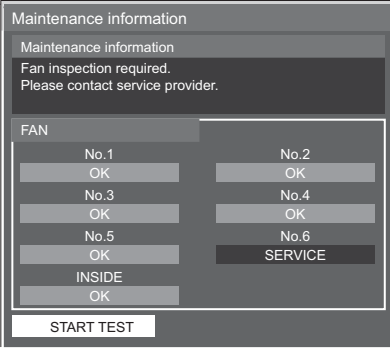
# Options Adjustments

Item	Adjustments
<b>Power On Message (No activity power off)</b>	Whether to show/hide No activity power off Precautions at the time of power ON is set. <b>On:</b> The warning precautions are shown at the time of power ON. <b>Off:</b> The warning precautions are not shown at the time of power ON. <b>Note:</b> This setting is enabled only if “No activity power off” is “Enable” (see page 33).
<b>Function button assign 1</b> <b>Function button assign 2</b>	Set the functions that operates when <sup>FUNCTION</sup> [1] [2] is pressed. <b>Signal:</b> The “Signal” menu is displayed. <b>Screensaver:</b> The “Screensaver” menu is displayed. <b>ECO menu:</b> The “ECO Mode settings” menu is displayed. <b>Set up TIMER:</b> The “Set up TIMER” menu is displayed. <b>DIGITAL LINK:</b> Switch to DIGITAL LINK inputs. If it is ET-YFB100, the input switch menu on the YFB100 side is displayed. <b>Maintenance:</b> Display the maintenance information. <b>Note:</b> Factory settings are as follows. FUNCTION1 button: DIGITAL LINK FUNCTION2 button: Maintenance <b>Use the FUNCTION button</b> The menu screen is displayed. (Example: Maintenance) <div style="display: flex; align-items: center; margin: 10px 0;"> <div style="text-align: center; margin-right: 10px;">             FUNCTION              [1] [2]           </div> <div style="font-size: 2em; margin-right: 10px;">➔</div> <div style="border: 1px solid black; padding: 5px; background-color: #f0f0f0;">  </div> </div> <p style="text-align: center;">Press the FUNCTION button to exit from the menu.</p>
<b>Power Switch Lock</b>	Sets the lock setting for the display Power switch. <b>On:</b> Power switch operation is disabled. <b>Off:</b> Power switch operation is enabled. <b>Note:</b> This function is only for TH-47LFX6U.

## Normalisation

When both main unit buttons and remote control are disabled due to the “Button lock”, “Remocon User level” or “Remote ID” adjustments, set all the values “Off” so that all the buttons are enabled again.

Press the  - / ▾ button on main unit together with <sup>R</sup>  button on the remote control and hold for more than 5 seconds. The “Shipping” menu is displayed and the lock is released when it disappears.

# Input Search

When a signal is not detected, another input with a signal is automatically selected.

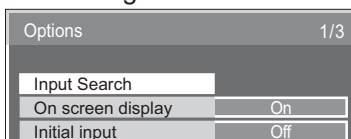

Press ACTION (■) button

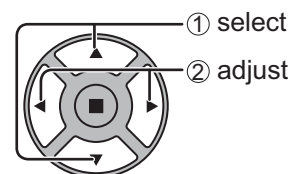
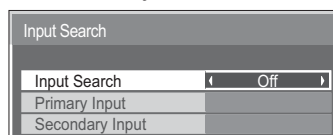

## Input Search

**Off:** When there is no signal, the input is not switched automatically.

**All Inputs:** Searches all inputs and switches to an input with a signal.

**Priority:** Searches “Primary Input” and “Secondary Input” in order and switches to an input with a signal.

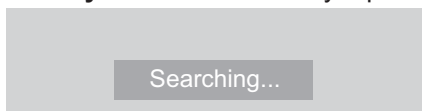

“Searching...” is displayed during the input search.

## Primary Input, Secondary Input

Set the input to search when “Priority” is selected.

(NONE) ↔ PC ↔ DVI ↔ HDMI ↔ DIGITAL LINK

**Note:** This menu is available only when “Input lock” is “Off”. (see page 46)



# Using Network Function

## Network Connection

This unit has a network function to control the network connected display with your computer.

**Note:**

To use the network function, set each “Network Setup” setting and make sure to set the “Control I/F Select” to “LAN”. (see page 43)

When “LAN” is set, power indicator lights orange under the condition of power “Off” with remote control (stand-by state).

**Example of network connection**

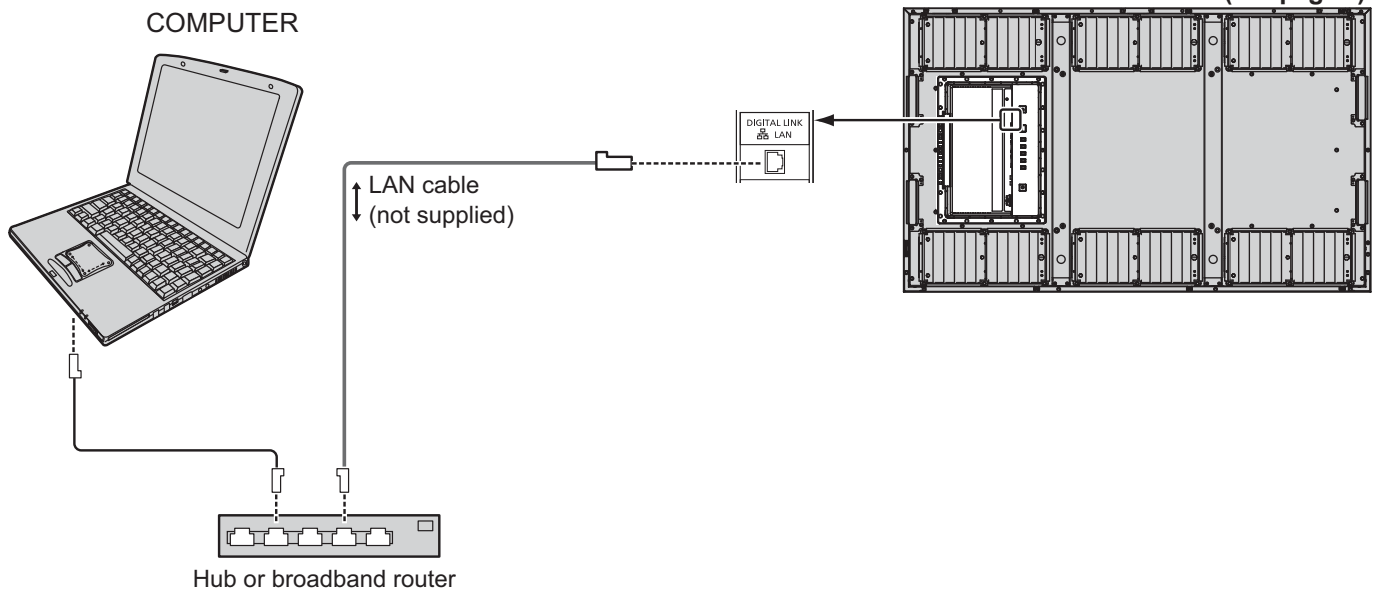

**Notes:**

- Make sure the broadband router or hub supports 100BASE-TX.
- Use a LAN cable that is compliant with “CAT5” or higher standards.
- Touching the DIGITAL LINK terminal with a statically charged hand (body) may cause damage due to its discharge.  
Do not touch the DIGITAL LINK terminal or a metal part of the LAN cable.
- For instructions on how to connect, consult your network administrator.

## DIGITAL LINK Connections (connecting with a twisted pair cable transmitter)

This device is equipped with functions that allow Ethernet signals from a twisted pair cable transmitter to be received through a LAN cable along with video/audio signals.

### Network connections via twisted pair cable transmitter

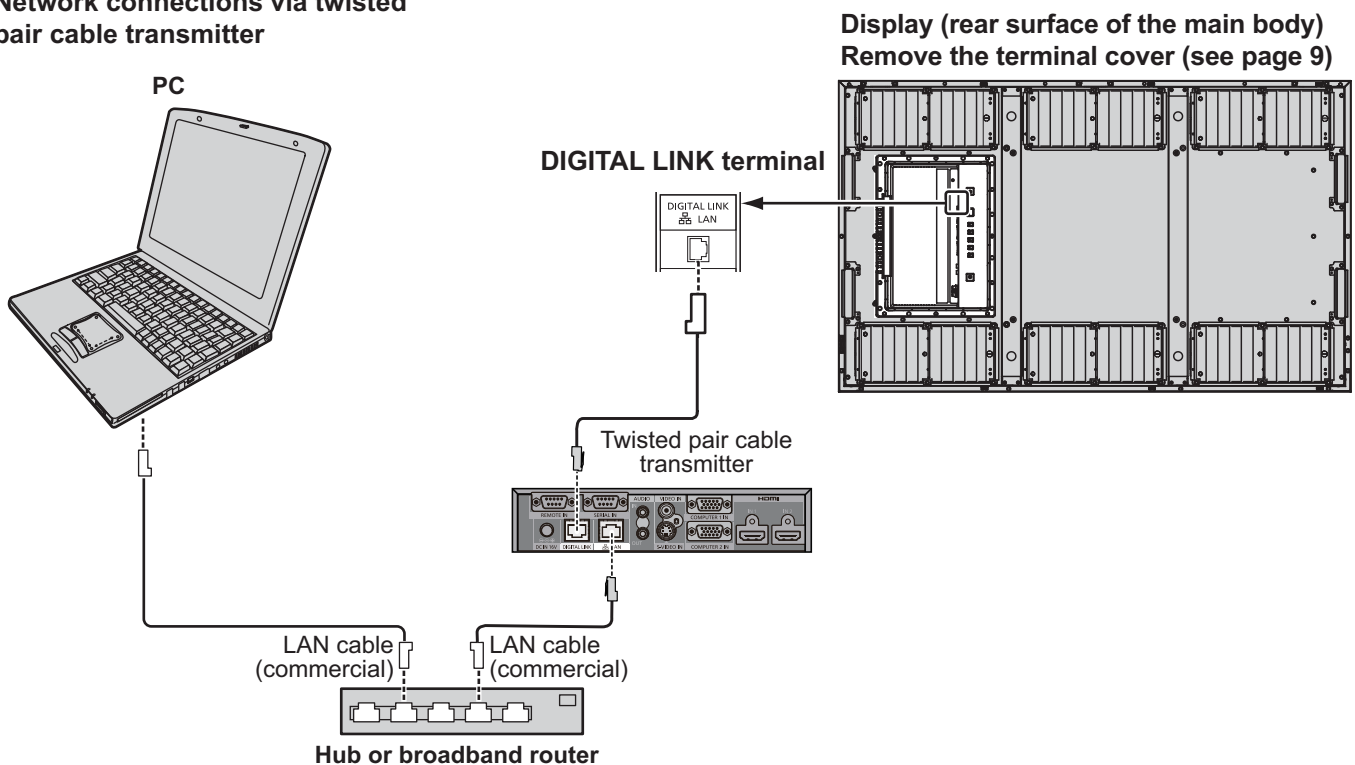

### Note:

Configure the settings in "Network Setup" when using a DIGITAL LINK connection. (see pages 43 to 45)

### Precautions for use while connecting with a twisted pair cable transmitter

#### Installing / Connecting

- Ask the dealer or a qualified technician to carry out the cable wiring work for DIGITAL LINK connections. Insufficient wiring work may cause the inability to apply the cable transmission characteristics and cropped or fuzzy images and sounds.
- The transmission distance between the twisted pair cable transmitter and the device is up to 100 meters. Exceeding this distance can cause cropped images or sounds, as well as LAN communication errors.
- Do not use a hub between the twisted pair cable transmitter and the Display.
- When connecting to the Display using the twisted pair cable transmitter (receiver) of other maker, do not use another twisted pair cable transmitter between the twisted pair cable transmitter of other maker and this device. The images and sounds may be interrupted or become unstable.
- If possible, lay the cable so that it is extended and not coiled in order to minimize both external and internal noise.
- Lay out cables of the twist pair cable transmitter and this product away from other cables, especially from the power supply cable.
- When laying multiple cables, keep them as close together as possible running parallelly and not bundled.
- After laying the cable(s), make sure that the signal quality in "DIGITAL LINK status" is -12 dB or below.

#### Twisted pair cables

- Use a LAN cable between the twisted pair cable transmitter and the device that conforms to the following conditions.
  - It meets or exceeds CAT5e standards
  - It is a straight cable
  - It is a shielded cable (with a connector)
  - It is a solid cable
- When laying the cable(s), use an instrument such as a cable tester or cable analyzer and check whether the cable characteristics are CAT5e or above. When using a relay connector along the path, also include this in the measurements.
- Do not pull cables hard. Also avoid forcefully bending or folding them.

#### Other

- This device is compatible with our Digital Interface Box (ET-YFB100). For the twisted pair cable transmitter of the other maker, refer to the following URL. (<http://panasonic.net/prodisplays/products/471fx6/index.html>)

# Command Control

Network function of the unit can control the unit in the same way as serial control from a network.

## Supported commands

Commands used in the serial control are supported. (see page 14)

### Note:

Consult your local Panasonic dealer for detail instructions on command usage.

# PJLink™ Protocol

The network function of the unit conforms with PJLink™ class 1 and you can operate the following actions from your computer using PJLink™ protocol.

- Display setup
- Display status query

## Supported commands

Commands to control the unit with PJLink™ protocol are shown in the table below.

Command	Control	Remark
POWR	Power control	Parameter 0 = Standby 1 = Power "On"
POWR ?	Power status query	Parameter 0 = Standby 1 = Power "On"
INPT	Input switch	Parameter
INPT ?	Input switch query	See the parameter for command INST ?
AVMT	Shutter control	Parameter 10 = Picture On (picture mute deactivated), 11 = Picture Off (picture on mute) 20 = Audio On (audio mute deactivated), 21 = Audio Off (audio on mute) 30 = Shutter mode Off (picture and audio mute deactivated) 31 = Shutter mode On (picture and audio on mute)
AVMT ?	Shutter control query	Parameter 11 = Picture Off (picture on mute) 21 = Audio Off (audio on mute) 30 = Shutter mode Off (picture and audio mute deactivated) 31 = Shutter mode On (picture and audio on mute)
ERST ?	Error status query	Parameter First byte: Means fan error. 0 or 2. Second byte: 0 Third byte: 0 Fourth byte: 0 Fifth byte: 0 Sixth byte: Means other error. 0 or 2. Meaning of the 0 – 2 settings: 0 = Error is not detected, 2 = Error
LAMP ?	Lamp status query	Not supported
INST ?	Input switch list query	Parameter 11: PC IN input (PC) 32: HDMI input (HDMI) 31: Digital Link input (Digital Link) 33: DVI-D IN input (DVI)
NAME ?	Projector name query	Returns empty character (no name information)
INF1 ?	Manufacturer name query	Returns "Panasonic"
INF2 ?	Model name query	Returns "TH-47LFX6"
INFO ?	Other information query	Returns version number
CLSS ?	Class information query	Returns "1"

## PJLink™ security authentication

Set "Panasonic" for the PJLink™ password.

- PJLink™ is a pending trademark in Japan, the United States, and other countries or areas.

# Using Web Browser Control

You can use a Web browser to control the unit and set up a network and password.

## Before Using Web Browser Control

To use the Web browser control, the unit and computer setups are required.

### Unit Setup

Set each “Network Setup” setting and make sure to set the “Control I/F Select” to “LAN”. (see page 43)

### Computer Setup

Disable the proxy server settings and enable JavaScript.

#### (Windows)

##### Disable proxy server settings

- 1 Display [Internet Properties] window.  
Click [Start] – [Control Panel] – [Network and Internet] – [Internet Options].
- 2 Click the [Connections] tab and then [LAN Settings].
- 3 Deselect the [Use automatic configuration script] and [Use a proxy server for your LAN] boxes.
- 4 Click [OK].

##### Enable JavaScript

- 1 Display [Internet Properties] window.  
Click [Start] – [Control Panel] – [Network and Internet] – [Internet Options].
- 2 Set the security level on the [Security] tab to [Default Level]. Alternatively enable [Active scripting] from the [Custom Level] button.

#### (Macintosh)

##### Disable proxy server settings

- 1 From the [Safari] menu, click [Preferences].  
General screen is displayed.
- 2 From the [Advanced] tab, click the [Change Settings...] button next to [Proxies]. Click [Proxies] and set up a proxy server.
- 3 Deselect the [Web Proxy] and [Automatic Proxy Configuration] boxes.
- 4 Click [Apply Now].

##### Enable JavaScript

- 1 Display [Security] of Safari.
- 2 Select [Enable JavaScript] under [Web content].

## Access from Web Browser

Access to the TOP screen of the Web browser control using a Web browser.

- 1 Start your Web browser.
- 2 Enter the IP address set with the “LAN Setup” of the unit.  
(see page 44)

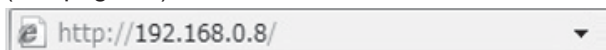

- 3 Enter the user name and password when the Authentication screen is displayed.

### Authentication screen

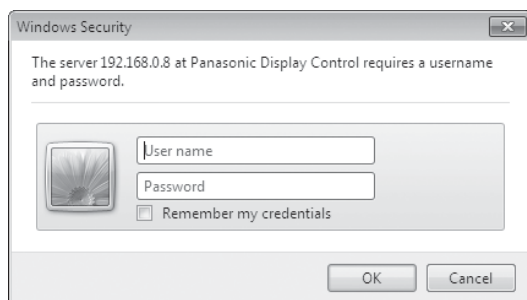

- 4 Click [OK].  
After logged in, the TOP screen of the Web browser control is displayed. (see page 53)

### Notes:

- The password used here is the same password used for command control and the PJLink™ security authentication.
- Default user name and password are as follows:  
User name: user1  
Password: Panasonic
- The password can be changed on the Password Setup screen after logging in (see page 54). The user name cannot be changed.
- Under no circumstances, Panasonic Corporation or its associated companies will ask customers their password directly.  
Even if you are asked directly, please do not reveal your password.

## TOP screen structure of the Web browser control

After logging in, the TOP screen of the Web browser control is displayed.

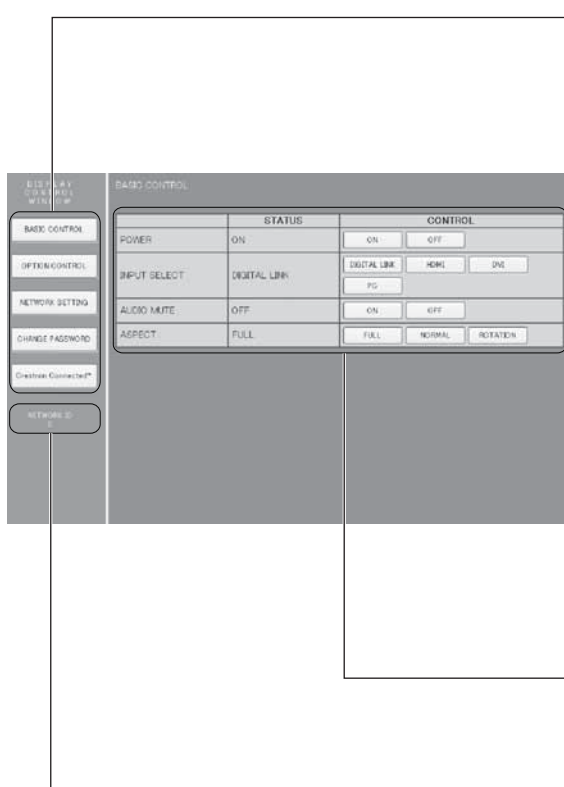

### ① Menu

Menu items are displayed. When a button is clicked, setup screen of each item is displayed.

Item	Details
BASIC CONTROL	BASIC CONTROL screen is displayed. (see below)
OPTION CONTROL	OPTION CONTROL screen is displayed. (see below)
NETWORK SETTING	Network Setup screen is displayed. (see page 54)
CHANGE PASSWORD	Password setup screen is displayed. (see page 54)
Crestron Connected™	The Crestron Connected™ operations screen will appear. (see pages 55, 56) <ul style="list-style-type: none"> <li>This button does not appear when "Crestron Connected™" in "Network Setup" is "OFF". (see page 43)</li> </ul>

② According to the selected item from the menu, setup status or set items are displayed.

### ③ Network ID information

ID to identify the unit is displayed.

## Display Control (BASIC CONTROL/OPTION CONTROL Screen)

Click BASIC CONTROL or OPTION CONTROL from the menu. Various controls of the unit can be set.

### BASIC CONTROL screen

Click BASIC CONTROL from the menu. Unit status and buttons to change settings are displayed.

	STATUS	CONTROL
POWER	ON	<input type="button" value="ON"/> <input type="button" value="OFF"/>
INPUT SELECT	DIGITAL LINK	<input type="button" value="DIGITAL LINK"/> <input type="button" value="HDMI"/> <input type="button" value="DVI"/> <input type="button" value="PG"/>
AUDIO MUTE	OFF	<input type="button" value="ON"/> <input type="button" value="OFF"/>
ASPECT	FULL	<input type="button" value="FULL"/> <input type="button" value="NORMAL"/> <input type="button" value="ROTATION"/>

Item	Details
POWER	Switch ON/OFF of the unit power.
INPUT SELECT	Switch the input signals. Displayed buttons vary according to the connection status of the video device.
AUDIO MUTE	Switch ON/OFF of the sound mute.
ASPECT	Switch the screen modes

### OPTION CONTROL screen

Click OPTION CONTROL from the menu. Command input field for command control of the unit is displayed.

COMMAND	<input type="text"/>
RESPONSE	<input type="text"/>
<input type="button" value="SEND"/>	

Item	Details
COMMAND	Enter a command. Use the same command used for the serial control. (see page 14)
RESPONSE	Response from the unit is displayed.
SEND	Command is sent and run.

#### Note:

After the settings are changed, it may take a while till the display's response is displayed.

# NETWORK SETTING (NETWORK SETTING Screen)

Click NETWORK SETTING from the menu. Various settings of a network can be set. For the details of the setting items, please check Network Setup under the Set up of the unit. (see page 44)

DHCP	<input type="radio"/> OFF <input checked="" type="radio"/> ON
IP ADDRESS	192.168.0.8
SUBNET MASK	255.255.255.0
GATEWAY	192.168.0.1
PORT	1024
LAN SPEED	<input checked="" type="radio"/> AUTO <input type="radio"/> 100 FULL <input type="radio"/> 100 HALF
NETWORK ID	0
<input type="button" value="SAVE"/>	

### Notes:

- To use a DHCP server, make sure the DHCP server is started.
- During a DHCP server is used, IP ADDRESS, SUBNET MASK, and GATEWAY values cannot be entered.
- When the set values are changed properly, "NETWORK SETTING CHANGED." message and the changed set items are displayed.

Item	Details
DHCP	Set to ON when a DHCP server is used, or OFF when it is not used.
IP ADDRESS	Enter an IP address.
SUBNET MASK	Enter a subnet mask.
GATEWAY	Enter a gateway address.
PORT	Enter the port number used for command control. The available setting range is 1024 - 65535.
LAN SPEED	Set the connection speed of the LAN environment.
NETWORK ID	Set the ID to identify this unit. The available setting range is 0 - 99.
SAVE	Save the each set value.

# Password Setting (CHANGE PASSWORD Screen)

Click CHANGE PASSWORD from the menu. Password to access the Web browser control can be set. When the password is changed in this screen, the password used for command control and the PJLink™ security authentication is also changed.

OLD PASSWORD	.....
NEW PASSWORD	.....
NEW PASSWORD (RETYPE)	.....
<input type="button" value="SAVE"/>	

### Notes:

- The default password is "Panasonic".
- Up to 32 alphanumeric characters can be used for a password.
- When the password is changed properly, "Password has changed." message is displayed.

Item	Details
OLD PASSWORD	Enter the old password.
NEW PASSWORD	Enter the new password.
NEW PASSWORD (RETYPE)	Enter the password entered in "NEW PASSWORD" for confirmation.
SAVE	Save the new password. The confirmation screen is displayed. Click OK to change the password.

## Crestron Connected™ page

You can monitor or control the Display using Crestron Connected™.

When you click [Crestron Connected™], the Crestron Connected™ operation page is displayed.

If Adobe Flash Player is not installed in your computer, or if the browser does not support Flash, this page does not appear. In this case, return to the previous page by clicking [Back] in the operation page.

### Operation page

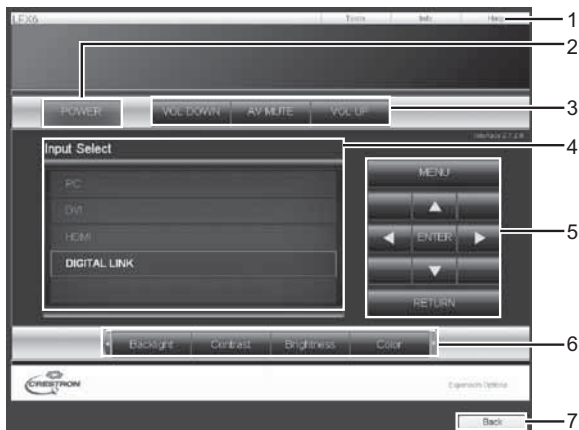

#### 1 Tools, Info, Help

Switches the pages for tools, information, help using the tab.

#### 2 POWER

Switches between on and off of the power.

#### 3 VOL DOWN, AV MUTE, VOL UP

Sets the volume, AV mute. When the power of the Display is turned off, VOL DOWN, AV MUTE and VOL UP are not available.

#### 4 Input Select

Sets the input selection. When the power of the Display is turned off, this operation is not available.

#### 5 Operation buttons on the menu screen

Operates on the menu screen.

#### 6 Image quality adjustments

Operate items related to image quality.

#### 7 Back

Returns to the previous page.

### Tools page

Click Tools on the operation page.

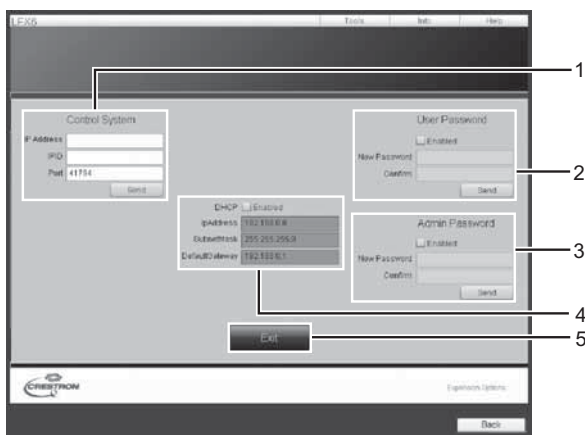

#### 1 Control system

Sets the information required for the communication with the controller that is connected to the Display.

#### 2 User Password

Sets the password for the user rights in the operation page of Crestron Connected™.

#### 3 Admin Password

Sets the password for the administrator rights in the operation page of Crestron Connected™.

#### 4 Network status

Displays the setting of LAN.

DHCP: Displays the value in the current setting.

IpAddress: Displays the value in the current setting.

SubnetMask: Displays the value in the current setting.

DefaultGateway: Displays the value in the current setting.

#### 5 Exit

Return to the operation page.

### Note:

When you monitor or control the Display using Crestron Connected™, set "Crestron Connected™" to "On" in the "Network Setup" menu. (see page 43)

## Info page

Click Info on the operation page.

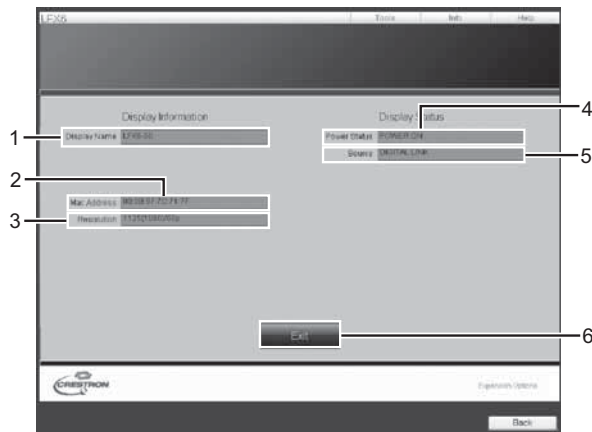

### 1 Display name

Displays the name of the Display.

### 2 Mac Address

Displays the MAC address.

### 3 Resolution

Displays the resolution of the Display.

### 4 Power Status

Displays the status of the power.

### 5 Source

Displays the selected video input.

### 6 Exit

Return the operation page.

## Help page

Click Help on the operation page.

The Help Desk screen is displayed.









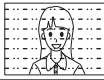

### 1 Help Desk

Sends or receive messages to the administrator who uses Crestron Connected™.



# Troubleshooting

Before you call for service, determine the symptoms and make a few simple checks as shown below.

Symptoms		Checks
Picture	Sound	
 Interference	 Noisy Sound	Electrical Appliances Cars / Motorcycles Fluorescent light
 Normal Picture	 No Sound	Volume (Check whether the mute function has been activated on the remote control.)
 No Picture	 No Sound	Not plugged into AC outlet Not switched on Picture and Brightness/Volume setting (Check by pressing the power switch or stand-by button on the remote control.)
 No Picture	 Normal Sound	If a signal with a non-applicable colour system format, or frequency is input, only the input terminal indication is displayed.
No remote control operations can be performed.		Check whether the batteries have discharged completely and, if they have not, whether they were inserted properly. Check whether the remote control sensor is exposed to an outdoor light or a strong fluorescent light. Check whether the remote control designed specifically for use with the unit is being used. (The unit cannot be operated by any other remote control.)
A cracking sound is sometimes heard from the unit.		If there is nothing wrong with the picture or sound, this is the sound of the cabinet undergoing very slight contractions in response to changes in the room temperature. There are no adverse effects on the performance or other aspects.
The top or bottom of the picture on the screen is cut off when I use the zoom function.		Adjust the position of the picture on the screen.
Areas at the top and bottom of the screen where the image is missing appear when I use the zoom function.		When using a video software program (such as a cinema size program) with a screen wider than one in the 16:9 mode, blank areas separate from the images are formed at the top and bottom of the screen.
I can hear sounds coming from inside the unit.		When the power is turned on, a sound of the fan may be heard: This is normal and not indicative of malfunctioning.
Parts of the unit become hot.		Even when the temperature of parts of the front, top and rear panels has risen, these temperature rises will not pose any problems in terms of performance or quality.
Power automatically turns off unexpectedly.		Check the settings of "No signal power off", "PC Power management", "DVI-D Power management" and "No activity power off". Any of them may be set to "On (Enable)". (see page 33, 34)
There is no picture displayed or sound output sometimes.		When HDMI or DVI signals are input to the Display using a selector or distributor, sound or images may not be output in the normal fashion depending on the selector or distributor used. The symptoms may be improved by turning the power off and on again, or by replacing the selector or distributor.
The RS232C is uncontrollable		Check whether the connection has been made properly. (see page 14) When controlling the RS232C command on page 14 from the RS232C terminal in the display, make sure that "Control I/F Select" is "RS-232C (Serial)", and that it is "RS-232C(DIGITAL LINK)" when controlling from the RS232C terminal of the DIGITAL LINK device. (see page 43) Check whether "LAN Setup" has been configured properly. (see page 44) (When controlling from the RS232C terminal of the DIGITAL LINK device)
The LAN is uncontrollable		Check whether the connection has been made properly. (see page 49) Check whether "Control I/F Select" is "LAN" when controlling with the WEB browser control or the command control on page 51. (see page 43) Check whether "LAN Setup" has been configured properly. (see page 44) When connecting to a device of AMX, Crestron Electronics, Inc., or Extron, set "AMX D.D.", "Crestron Connected™", or "Extron XTP" according to the device to use. (see page 43) See the "Signal quality" information of "DIGITAL LINK status" to check the LAN cable status such as whether the LAN cable is disconnected or the cable is not shielded. (see page 45)
There is no picture displayed or sound output from the DIGITAL LINK terminal.		Check whether the connection has been made properly between the video (output) equipment and twisted pair cable transmitter and between the twisted pair cable transmitter and this product. (see page 15) Check whether "DIGITAL LINK mode" is set to "Auto" or "DIGITAL LINK" instead of "Ethernet". (see page 43)
This LCD Display uses special image processing. Hence a slight time lag may occur between image and audio, depending on the type of input signal. However, this is not a malfunction.		

# Troubleshooting

## LCD Display panel

Symptoms	Check
The screen darkens slightly when bright pictures with minimal movements are shown.	The screen will darken slightly when photos, still images of a computer or other pictures with minimal movements are shown for an extended period. This is done to reduce image retention on the screen and the shortening of the screen's service life: It is normal and not indicative of malfunctioning.
It takes a while for the picture to appear.	The unit digitally processes the various signals in order to reproduce esthetically pleasing images. As such, it sometimes takes a few moments for the picture to appear when the power has been turned on, when the input has been switched.
The edges of the images flicker.	Due to the characteristics of the system used to drive the panel, the edges may appear to flicker in the fast-moving parts of the images: This is normal and not indicative of malfunctioning.
There may be red spots, blue spots, green spots and black spots on the screen.	This is a characteristic of liquid crystal panels and is not a problem. The liquid crystal panel is built with very high precision technology giving you fine picture details. Occasionally, a few non-active pixels may appear on the screen as fixed points of red, blue, green, or black. Please note this does not affect the performance of your LCD.
<div data-bbox="183 591 386 701" data-label="Image"> </div> <p data-bbox="161 725 408 750">Image retention appears</p>	Image retention may occur. If you display a still picture for an extended period, the image might remain on the screen. However, it will disappear after a while. This is not considered as malfunction.

# Applicable Input Signals

## PC signals

\*Mark: Applicable input signal

	Signal name	Horizontal frequency (kHz)	Vertical frequency (Hz)	PC IN (Dot clock (MHz))	DVI-D IN (Dot clock (MHz))	HDMI
1	640x400@70Hz	31.46	70.07	* (25.17)		
2	640x480@60Hz	31.47	59.94	* (25.18)	* (25.18)	*
3	640x480@72Hz	37.86	72.81	* (31.5)		
4	640x480@75Hz	37.50	75.00	* (31.5)		
5	640x480@85Hz	43.27	85.01	* (36.0)		
6	800x600@56Hz	35.16	56.25	* (36.0)		
7	800x600@60Hz	37.88	60.32	* (40.0)	* (40.0)	*
8	800x600@72Hz	48.08	72.19	* (50.0)		
9	800x600@75Hz	46.88	75.00	* (49.5)		
10	800x600@85Hz	53.67	85.06	* (56.25)		
11	852x480@60Hz	31.47	59.94		* (33.24)	*
12	1024x768@50Hz	39.55	50.00		* (51.89)	*
13	1024x768@60Hz	48.36	60.00	* (65.0)	* (65.0)	*
14	1024x768@70Hz	56.48	70.07	* (75.0)		
15	1024x768@75Hz	60.02	75.03	* (78.75)		
16	1024x768@85Hz	68.68	85.00	* (94.5)		
17	1066x600@60Hz	37.64	59.94		* (53.0)	*
18	1152x864@60Hz	53.70	60.00		* (81.62)	*
19	1152x864@75Hz	67.50	75.00	* (108.0)		
20	1280x768@60Hz	47.70	60.00	* (80.14)		
21	1280x960@60Hz	60.00	60.00	* (108.0)		
22	1280x960@85Hz	85.94	85.00	* (148.5)		
23	1280x1024@60Hz	63.98	60.02	* (108.0)	* (108.0)	*
24	1280x1024@75Hz	79.98	75.02	* (135.0)		
25	1280x1024@85Hz	91.15	85.02	* (157.5) *1		
26	1366x768@50Hz	39.55	50.00		* (69.92)	*
27	1366x768@60Hz	48.36	60.00	* (86.71)	* (87.44)	*
28	1400x1050@60Hz	65.22	60.00		* (122.61)	*
29	1600x1200@60Hz	75.00	60.00	* (162.0)	* (162.0)	*
30	1920x1080@60Hz	67.50	60.00	* (148.5)	* (148.5)	*
31	1920x1200@60Hz	74.04	59.95		* (154.0)	*
32	Macintosh13"(640x480)	35.00	66.67	* (30.24)		
33	Macintosh16"(832x624)	49.72	74.55	* (57.28)		
34	Macintosh21"(1152x870)	68.68	75.06	* (100.0)		

\*1 Not compatible with Sync on G.

- The signal format automatically detected may differ from the actual input signal in display.
- The corresponding signals for DIGITAL LINK inputs are the same as those for HDMI inputs.

## Component signals

\*Mark: Applicable input signal

	Signal name	Horizontal frequency (kHz)	Vertical frequency (Hz)	DVI-D IN (Dot clock (MHz))	HDMI
1	525(480)/60i	15.73	59.94	* (27.0)	*
2	525(480)/60p	31.47	59.94	* (27.0)	*
3	625(575)/50i	15.63	50.00		
4	625(576)/50i	15.63	50.00	* (27.0)	*
5	625(575)/50p	31.25	50.00		*
6	625(576)/50p	31.25	50.00	* (27.0)	*
7	750(720)/60p	45.00	60.00	* (74.25)	*
8	750(720)/50p	37.50	50.00	* (74.25)	*
9	1,125(1,080)/60p	67.50	60.00	* (148.5)	*
10	1,125(1,080)/60i	33.75	60.00	* (74.25)	*
11	1,125(1,080)/50p	56.25	50.00	* (148.5)	*
12	1,125(1,080)/50i	28.13	50.00	* (74.25)	*
13	1,125(1,080)/24sF	27.00	48.00		
14	1,125(1,080)/30p	33.75	30.00	* (74.25)	*
15	1,125(1,080)/25p	28.13	25.00	* (74.25)	*
16	1,125(1,080)/24p	27.00	24.00	* (74.25)	*

# Shipping condition

This function allows you to reset the unit to the factory setting.

**1**  Press to display the Setup menu.

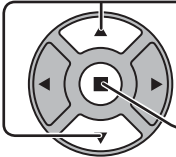
**2**  Press to select "OSD Language".  
Press for more than 3 seconds.

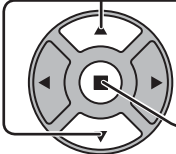
**3**  Press to select "Shipping".  
Press to display the Shipping menu.

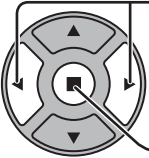
**4**  Press to select "YES".  
Press to confirm.

**5** Wait for 10 seconds.

**6**  Press the power switch (⏻/⏻) on main unit to turn the power off.

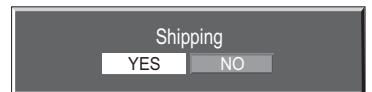
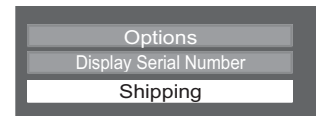
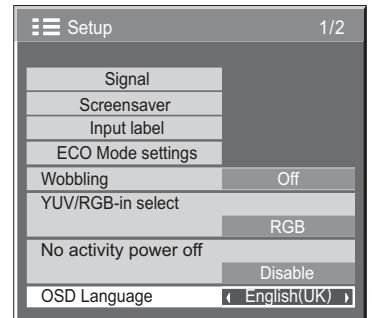

[from the unit]

- 1 Press the MENU button till the Setup menu is displayed.
- 2 Press the Volume Up "+" or Down "-" button to select "OSD Language".
- 3 Press and hold the ENTER button till the Shipping menu is displayed.
- 4 Press the Volume Up "+" or Down "-" button to select "YES".
- 5 Press the ENTER button and wait for 10 sec.
- 6 Press the power switch (⏻/⏻) on main unit to turn the power off.

# Specifications

	TH-47LFX6U	TH-47LFX6W
<b>Power Source</b>	110 - 127 V AC, 50/60 Hz	220 - 240 V AC, 50/60 Hz
<b>Power Consumption</b>		
Power on	370 W	
Power off condition	0.3 W	
Stand-by condition	0.5 W	
	Outdoor mode On: 41 W Network stand-by mode: 16 W	
<b>LCD Display panel</b>	47-inch IPS panel, 16:9 aspect ratio	
<b>Screen size</b>	40.9" (W) × 23.0" (H) × 46.9" (diagonal) / 1,039 mm (W) × 584 mm (H) × 1,192 mm (diagonal)	
(No. of pixels)	2,073,600 (1,920 (W) × 1,080 (H)) [5,760 × 1,080 dots]	
<b>Operating condition</b>		
Temperature	32 °F - 104 °F / 0 °C - 40 °C* (during Outdoor mode: -4 °F - 104 °F / -20 °C - 40 °C)	
<b>Applicable signals</b>		
Scanning format	525 (480) / 60i · 60p, 625 (575) / 50i · 50p, 750 (720) / 60p · 50p, 1125 (1080) / 60i · 60p · 50i · 50p · 24p · 25p · 30p · 24sF	
PC signals	VGA, SVGA, XGA, SXGA UXGA .... (compressed) Horizontal scanning frequency 30 - 110 kHz Vertical scanning frequency 48 - 120 Hz	
<b>Connection terminals</b>		
DIGITAL LINK	For RJ45 network and DIGITAL LINK connections, compatible with PLink™ Communication method: RJ45 100BaseTX	
HDMI	TYPE A Connector	
DVI-D IN	DVI-D 24 Pin Content Protection	Compliance with DVI Revision 1.0 Compatible with HDCP 1.1
AUDIO	Stereo mini jack (M3) × 1	0.5 Vrms, Shared with PC IN
PC IN	High-Density Mini D-sub 15 Pin	G with sync 1.0 Vp-p (75 Ω) G without sync 0.7 Vp-p (75 Ω) B: 0.7 Vp-p (75 Ω) R: 0.7 Vp-p (75 Ω) HD/VD: 1.0 - 5.0 Vp-p (high impedance)
AUDIO	Stereo mini jack (M3) × 1	0.5 Vrms, Shared with DVI-D IN
SERIAL	External Control Terminal D-sub 9 Pin	RS-232C compatible
AUDIO OUT	L-R RCA PIN JACK × 2 (L / R) Output level: Variable (-∞ — 0 dB)	[INPUT 1 kHz / 0 dB, 10 kΩ Load]
<b>Dimensions (W × H × D)</b>	46" × 27.8" × 8.6" 1,162 mm × 706 mm × 216 mm	
<b>Mass (weight)</b>	approx. 109 lbs / 49.5 kg	

## Notes:

- Design and specifications are subject to change without notice. Mass and dimensions shown are approximate.
- This equipment complies with the EMC standards listed below.  
EN55022, EN55024, EN61000-3-2, EN61000-3-3.
- "DIGITAL LINK" is the technology of transmitting signals from images, sounds, etc. with a twisted pair cable, and the original name of our projector and display.

## <Software Information for This Product>

This product has software installed partially licensed under the Free BSD LICENSE.

Free BSD LICENSE regulations under the above specifications are as follows:

(These regulations are set by the third party; therefore the original (English) regulations are stated.)

Copyright © 1980, 1986, 1993

The Regents of the University of California. All rights reserved.

Redistribution and use in source and binary forms, with or without modification, are permitted provided that the following conditions are met:

1. Redistributions of source code must retain the above copyright notice, this list of conditions and the following disclaimer.
2. Redistributions in binary form must reproduce the above copyright notice, this list of conditions and the following disclaimer in the documentation and/or other materials provided with the distribution.
3. All advertising materials mentioning features or use of this software must display the following acknowledgement:  
This product includes software developed by the University of California, Berkeley and its contributors.
4. Neither the name of the University nor the names of its contributors may be used to endorse or promote products derived from this software without specific prior written permission.

THIS SOFTWARE IS PROVIDED BY THE REGENTS AND CONTRIBUTORS "AS IS" AND ANY EXPRESS OR IMPLIED WARRANTIES, INCLUDING, BUT NOT LIMITED TO, THE IMPLIED WARRANTIES OF MERCHANTABILITY AND FITNESS FOR A PARTICULAR PURPOSE ARE DISCLAIMED. IN NO EVENT SHALL THE REGENTS OR CONTRIBUTORS BE LIABLE FOR ANY DIRECT, INDIRECT, INCIDENTAL, SPECIAL, EXEMPLARY, OR CONSEQUENTIAL DAMAGES (INCLUDING, BUT NOT LIMITED TO, PROCUREMENT OF SUBSTITUTE GOODS OR SERVICES; LOSS OF USE, DATA, OR PROFITS; OR BUSINESS INTERRUPTION) HOWEVER CAUSED AND ON ANY THEORY OF LIABILITY, WHETHER IN CONTRACT, STRICT LIABILITY, OR TORT (INCLUDING NEGLIGENCE OR OTHERWISE) ARISING IN ANY WAY OUT OF THE USE OF THIS SOFTWARE, EVEN IF ADVISED OF THE POSSIBILITY OF SUCH DAMAGE.

## Information for Users on Collection and Disposal of Old Equipment and used Batteries



These symbols on the products, packaging, and/or accompanying documents mean that used electrical and electronic products and batteries should not be mixed with general household waste. For proper treatment, recovery and recycling of old products and used batteries, please take them to applicable collection points, in accordance with your national legislation and the Directives 2002/96/EC and 2006/66/EC.

By disposing of these products and batteries correctly, you will help to save valuable resources and prevent any potential negative effects on human health and the environment which could otherwise arise from inappropriate waste handling.

For more information about collection and recycling of old products and batteries, please contact your local municipality, your waste disposal service or the point of sale where you purchased the items. Penalties may be applicable for incorrect disposal of this waste, in accordance with national legislation.

### For business users in the European Union

If you wish to discard electrical and electronic equipment, please contact your dealer or supplier for further information.

### [Information on Disposal in other Countries outside the European Union]

These symbols are only valid in the European Union. If you wish to discard these items, please contact your local authorities or dealer and ask for the correct method of disposal.

### Note for the battery symbol (bottom two symbol examples):

This symbol might be used in combination with a chemical symbol. In this case it complies with the requirement set by the Directive for the chemical involved.



Cd

USA only: This product has a fluorescent lamp that contains mercury. Disposal may be regulated in your community due to environmental considerations. For disposal or recycling information, please visit Panasonic website: <http://www.panasonic.com/environmental> or call 1-888-769-0149.

### Customer's Record

The model number and serial number of this product can be found on its rear panel. You should note this serial number in the space provided below and retain this book, plus your purchase receipt, as a permanent record of your purchase to aid in identification in the event of theft or loss, and for Warranty Service purposes.

Model Number \_\_\_\_\_

Serial Number \_\_\_\_\_

### For TH-47LFX6U

#### Panasonic System Communications Company of North America

Unit of Panasonic Corporation of North America

#### Executive Office :

Three Panasonic Way 2F-5, Secaucus, NJ 07094

#### Panasonic Canada Inc.

5770 Ambler Drive  
Mississauga, Ontario  
L4W 2T3

### For TH-47LFX6W

Pursuant to the directive 2004/108/EC, article 9(2)

Panasonic Testing Centre

Panasonic Service Europe, a division of Panasonic Marketing Europe GmbH

Winsbergring 15, 22525 Hamburg, F.R. Germany

**Panasonic Corporation**

Web Site : <http://panasonic.net>

© Panasonic Corporation 2013

M0413-2063