

## Operating Instructions Functional Manual

DLP™ Projector Commercial Use

---

Model No. **PT-RZ470EK**  
**PT-RZ470EW**  
**PT-RW430EK**  
**PT-RW430EW**

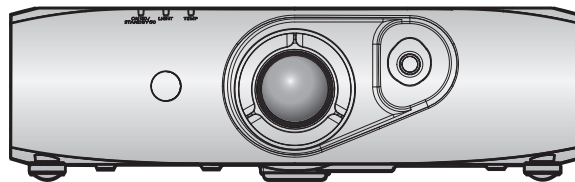

Thank you for purchasing this Panasonic product.

- The Operating Instructions correspond to the firmware's main version 3.02 and higher.
- Before operating this product, please read the instructions carefully and save this manual for future use.
- Before using your projector, be sure to read "Read this first!" (➔ pages 2 to 9).



## Read this first!

**WARNING:** THIS APPARATUS MUST BE EARTHED.

**WARNING:** To prevent damage which may result in fire or shock hazard, do not expose this appliance to rain or moisture.  
This device is not intended for use in the direct field of view at visual display workplaces. To avoid incommoding reflexions at visual display workplaces this device must not be placed in the direct field of view.  
The equipment is not intended for used at a video workstation in compliance BildscharbV.

The sound pressure level at the operator position is equal or less than 70 dB (A) according to ISO 7779.

**WARNING:**

1. Remove the plug from the mains socket when this unit is not in use for a prolonged period of time.
2. To prevent electric shock, do not remove cover. No user serviceable parts inside. Refer servicing to qualified service personnel.
3. Do not remove the earthing pin on the mains plug. This apparatus is equipped with a three prong earthingtype mains plug. This plug will only fit an earthing-type mains socket. This is a safety feature. If you are unable to insert the plug into the mains socket, contact an electrician. Do not defeat the purpose of the earthing plug.

**WARNING:**

This is a class A product. In a domestic environment this product may cause radio interference in which case the user may be required to take adequate measures.

**CAUTION:** To assure continued compliance, follow the attached installation instructions, which include using the provided power cord and shielded interface cables when connecting to computer or peripheral device. If you use serial port to connect PC for external control of projector, you must use a commercial RS-232C serial interface cable with ferrite core. Any unauthorized changes or modifications to this equipment will void the user's authority to operate.

This is a device to project images onto a screen, etc., and is not intended for use as indoor lighting in a domestic environment.

Directive 2009/125/EC

### Notice on laser

This projector is the Class 1 laser product that complies with IEC 60825-1.

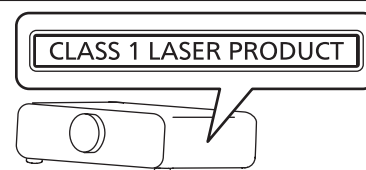

### Product information (for Turkey only)

EEE Yönetmeliğine Uygundur.  
EEE Complies with Directive of Turkey.

Importer's name and address within the European Union

Panasonic Marketing Europe GmbH

Panasonic Testing Center

Winsbergring 15, 22525 Hamburg, Germany

**RISK GROUP 3**

**WARNING:** POSSIBLY HAZARDOUS OPTICAL RADIATION EMITTED FROM THIS PRODUCT.  
**AVERTISSEMENT:** DES RADIATIONS OPTIQUES NUISIBLES PEUVENT ÊTRE EMISES PAR CE PRODUIT.  
**WARNUNG:** DIESES PRODUKT EMITTIERT MÖGLICHERWEISE GEFÄHRLICHE OPTISCHE STRAHLUNG.  
**ПРЕДУПРЕЖДЕНИЕ:** ДАННАЯ ПРОДУКЦИЯ МОЖЕТ СОЗДАВАТЬ ОПАСНОЕ ОПТИЧЕСКОЕ ИЗЛУЧЕНИЕ.  
**경고:** 본 제품에서 유해한 광방사가 방출되었을 가능성이 있습니다.

TQFX340

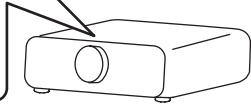

(Top of product)

## **WARNING:**

### **■ POWER**

**The wall outlet or the circuit breaker shall be installed near the equipment and shall be easily accessible when problems occur. If the following problems occur, cut off the power supply immediately.**

Continued use of the projector in these conditions will result in fire or electric shock.

- If foreign objects or water get inside the projector, cut off the power supply.
- If the projector is dropped or the cabinet is broken, cut off the power supply.
- If you notice smoke, strange smells or noise coming from the projector, cut off the power supply.

Please contact an Authorized Service Center for repairs, and do not attempt to repair the projector yourself.

**During a thunderstorm, do not touch the projector or the cable.**

Electric shocks can result.

**Do not do anything that might damage the power cord or the power plug.**

If the power cord is used while damaged, electric shocks, short-circuits or fire will result.

- Do not damage the power cord, make any modifications to it, place it near any hot objects, bend it excessively, twist it, pull it, place heavy objects on top of it or wrap it into a bundle.

Ask an Authorized Service Center to carry out any repairs to the power cord that might be necessary.

**Completely insert the power plug into the wall outlet and the power connector into the projector terminal.**

If the plug is not inserted correctly, electric shocks or overheating will result.

- Do not use plugs which are damaged or wall outlets which are coming loose from the wall.

**Do not use anything other than the provided power cord.**

Failure to observe this will result in fire or electric shocks. Please note that if you do not use the provided power cord to ground the device on the side of the outlet, this may result in electric shocks.

**Clean the power plug regularly to prevent it from becoming covered in dust.**

Failure to observe this will cause a fire.

- If dust builds up on the power plug, the resulting humidity can damage the insulation.
- If not using the projector for an extended period of time, pull the power plug out from the wall outlet.

Pull the power plug out from the wall outlet and wipe it with a dry cloth regularly.

**Do not handle the power plug and power connector with wet hands.**

Failure to observe this will result in electric shocks.

**Do not overload the wall outlet.**

If the power supply is overloaded (ex., by using too many adapters), overheating may occur and fire will result.

### **■ ON USE/INSTALLATION**

**Do not place the projector on soft materials such as carpets or sponge mats.**

Doing so will cause the projector to overheat, which can cause burns, fire or damage to the projector.

**Do not set up the projector in humid or dusty places or in places where the projector may come into contact with oily smoke or steam, ex. a bathroom.**

Using the projector under such conditions will result in fire, electric shocks or deterioration of components.

Deterioration of components (such as ceiling mount brackets) may cause the projector which is mounted on the ceiling to fall down.

**Do not install this projector in a place which is not strong enough to take the full weight of the projector or on top of a surface which is sloped or unstable.**

Failure to observe this will cause projector to fall down or tip over the projector, and severe injury or damage could result.

**WARNING:**

**Do not cover the air intake/exhaust ports or place anything within 500 mm (20") of them.**

Doing so will cause the projector to overheat, which can cause fire or damage to the projector.

- Do not place the projector in narrow, badly ventilated places.
- Do not place the projector on cloth or papers, as these materials could be drawn into the air intake port.

**Do not look at the light emitted from the lens while the projector is being used.**

Doing so can cause loss of sight.

- Strong light is emitted from the projector's lens. Do not directly look at this light.

**Do not expose your eyes and skin to the projection light while the projector is being used.**

Possibly hazardous optical radiation is emitted from this product, causing damage to your eyes and skin.

- Be especially careful not to let young children look into the lens. In addition, turn off the power and disconnect the power plug when you are away from the projector.

**Never attempt to remodel or disassemble the projector.**

High voltages can cause fire or electric shocks.

- For any inspection, adjustment and repair work, please contact an Authorized Service Center.

Doing so may cause exposure to dangerous laser radiation.

- The laser module is built in this projector. Follow procedures specified in the Operating Instructions to make operations and adjustments.

**Do not allow metal objects, flammable objects, or liquids to enter inside of the projector. Do not allow the projector to get wet.**

Doing so may cause short circuits or overheating, and result in fire, electric shock, or malfunction of the projector.

- Do not place containers of liquid or metal objects near the projector.
- If liquid enters inside of the projector, consult your dealer.
- Particular attention must be paid to children.

**Use the ceiling mount bracket specified by Panasonic.**

Using the ceiling mount bracket other than the specified one will result in falling accidents.

- Attach the supplied safety cable to the ceiling mount bracket to prevent the projector from falling down.

**Installation work (such as ceiling mount bracket) should only be carried out by a qualified technician.**

If installation is not carried out and secured correctly, it can cause injury or accidents, such as electric shocks.

- Be sure to use the wire provided with the ceiling mount bracket as an extra safety measure to prevent the projector from falling down. (Install in a different location to the ceiling mount bracket.)

**WARNING:**

■ **ACCESSORIES**

**Do not use or handle the batteries improperly, and refer to the following.**

Failure to observe this will cause burns, batteries to leak, overheat, explode or catch fire.

- Use AA/R6/LR6 batteries.
- Do not use unspecified batteries.
- Do not use chargeable batteries.
- Do not disassemble dry cell batteries.
- Do not heat the batteries or place them into water or fire.
- Do not allow the + and – terminals of the batteries to come into contact with metallic objects such as necklaces or hairpins.
- Do not store or carry batteries together with metallic objects.
- Store the batteries in a plastic bag and keep them away from metallic objects.
- Make sure the polarities (+ and –) are correct when inserting the batteries.
- Do not use a new battery together with an old battery or mix different types of batteries.
- Do not use batteries with the outer cover peeling away or removed.

**If the battery fluid leaks, do not touch it with bare hands, and take the following measures if necessary.**

- Battery fluid on your skin or clothing could result in skin inflammation or injury.  
Rinse with clean water and seek medical advice immediately.
- Battery fluid coming in contact with your eyes could result in loss of sight.  
In this case, do not rub your eyes. Rinse with clean water and seek medical advice immediately.

**Do not use the supplied power cord with devices other than this projector.**

- Using the supplied power cord with devices other than this projector may cause short circuits or overheating, and result in electric shock or fire.

**Remove the depleted batteries from the remote control promptly.**

- Leaving them in the unit may result in fluid leakage, overheating, or explosion of the batteries.

## CAUTION:

### ■ POWER

**When disconnecting the power cord, be sure to hold the power plug and power connector.**

If the power cord itself is pulled, the lead will become damaged, and fire, short-circuits or serious electric shocks will result.

**When not using the projector for an extended period of time, disconnect the power plug from the wall outlet.**

Failure to do so may result in fire or electric shock.

**Disconnect the power plug from the wall outlet before carrying out any cleaning.**

Failure to do so may result in electric shock.

### ■ ON USE/INSTALLATION

**Do not place heavy objects on top of the projector.**

Failure to observe this will cause the projector to become unbalanced and fall, which could result in damage or injury. The projector will be damaged or deformed.

**Do not put your weight on this projector.**

You could fall or the projector could break, and injury will result.

- Be especially careful not to let young children stand or sit on the projector.

**Do not place the projector in extremely hot locations.**

Doing so will cause the outer casing or internal components to deteriorate, or result in fire.

- Take particular care in locations exposed to direct sunlight or near stoves.

**Do not place your hands or other objects close to the air exhaust port.**

Doing so will cause burns or damage your hands or other objects.

- Heated air comes out of the air exhaust port. Do not place your hands or face, or objects which cannot withstand heat close to this port.

**Always disconnect all cables before moving the projector.**

Moving the projector with cables still attached can damage the cables, which will cause fire or electric shocks to occur.

**When mounting the projector on the ceiling, keep mounting screws and power cord from contact with metal parts inside the ceiling.**

Contact with metal parts inside the ceiling can cause electric shocks.

### ■ ACCESSORIES

**Ask your dealer about cleaning inside the projector every 20 000 hours of usage as an estimated duration.**

Continuous use while dust is accumulated inside the projector may result in fire.

- For cleaning fee, ask your dealer.

**When not using the projector for an extended period of time, remove the batteries from the remote control.**

Failure to observe this will cause the batteries to leak, overheat, catch fire or explode, which may result in fire or contamination of surrounding area.

**CAUTION:**

■ **VIEWING 3D VIDEO**

**Those with a medical history of oversensitivity to light, heart problems, or poor physical health should not view 3D images.**

This may lead to a worsening of medical conditions.

**If you feel tiredness or discomfort, or other abnormality while viewing with 3D Eyewear, discontinue viewing.**

Continuing use may cause health problems. Take a break as necessary.

**When viewing 3D movies, aim to view one movie at a time and take a break as necessary.**

**When viewing 3D images, for example when playing 3D games or using a PC where two way interaction is possible, take an appropriate break every 30 to 60 minutes.**

Watching for long periods of time may cause eye fatigue.

**When preparing contents, use contents properly created to be used for 3D.**

This may cause eye fatigue or health problems.

**When viewing 3D images, pay attention to people and objects in the vicinity.**

3D video may be mistaken for actual objects, and the related bodily movements can cause damage to objects and lead to injury.

**Use 3D Eyewear when viewing 3D videos.**

**Do not tilt your head when viewing with 3D Eyewear.**

**Those who are near or far sighted, those with weaker eyesight in one eye, or those with astigmatism should use corrective glasses etc. when using 3D Eyewear.**

**If the image appears distinctly double when viewing 3D video, discontinue viewing.**

Watching for long periods of time may cause eye fatigue.

**View at a distance of at least three times the effective height of the screen.**

Viewing at distance closer than the recommended distance may cause eye fatigue. As with movies, if there are black bands at the top and bottom of the video, view at a distance of 3 times or more of the height of the video section.

**Children younger than 5 or 6 years old should not use 3D Eyewear.**

As it is difficult to gauge the reactions of children to fatigue and discomfort their condition may worsen suddenly. If a child uses the 3D Eyewear, guardians should beware of the child's eyes becoming tired.





## To remove the battery

### Remote Control Battery

1. Press the guide and lift the cover.

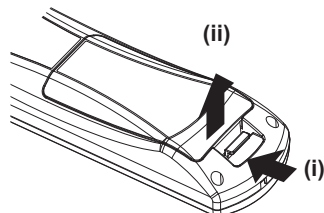

2. Remove the batteries.

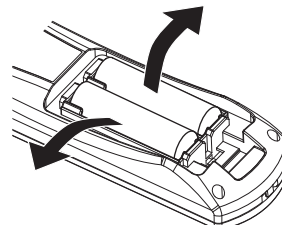

---

## ■ Trademarks

- SOLID SHINE is a trademark of Panasonic Corporation.
- RealD 3D is a trademark of RealD Inc.
- Windows®, Windows Vista®, and Internet Explorer® are registered trademarks or trademarks of Microsoft Corporation in the United States and other countries.
- Mac, Mac OS, OS X, and Safari are registered trademarks of Apple Inc. in the United States and other countries.
- PJLink™ is a registered trademark or pending trademark in Japan, the United States, and other countries and regions.
- HDMI, the HDMI Logo, and High-Definition Multimedia Interface are trademarks or registered trademarks of HDMI Licensing LLC in the United States and other countries.
- VGA and XGA are trademarks of International Business Machines Corporation in the United States.
- SVGA is a trademark or registered trademark of Video Electronics Standards Association.
- RoomView and Crestron RoomView are trademarks of Crestron Electronics, Inc.  
Crestron Connected and Fusion RV are trademarks of Crestron Electronics, Inc.
- Adobe Flash Player is a trademark or registered trademark of Adobe Systems Inc. in the United States and/or in other countries.
- All other names, company names, and product names mentioned in this manual are trademarks or registered trademarks of their respective owners.  
Please note that the ® and ™ symbols are not specified in this manual.

## ■ Illustrations in this manual

- Illustrations of the projector, screen, and other parts may vary from the actual product.

## ■ Reference pages

- Reference pages in this manual are indicated as (➡ page 00).

## ■ Term

- In this manual, the “Wireless remote control unit” accessory is referred to as “Remote control”.

---

## Features of the Projector

---

---

### Easy setup and improved serviceability

---

- ▶ In addition to the 2x zoom lens and wide lens shift, the portrait setting is supported. Also, a highly flexible setup is achieved through DIGITAL LINK (➔ page 18) support.

---

### Long-life reliability achieved

---

- ▶ The reliability is enhanced through the power-driving and unique cooling control system that maximizes the life of the light source, and complete hermeticity of the light source unit, achieving the maintenance-free projector for a long time.

---

### Energy conservation achieved through the ECO function

---

- ▶ The function to reduce power consumption is installed, which is optimizing the light source power according to the brightness of the surroundings, input signal, and video mute status.

---

### Improved system performance

---

- ▶ A wide range of uses are available, with the installation of the edge blending function and multiple-projector brightness control function, as well as the support for 3D projection (VESA standard IR system, DLP Link system).

---

## Quick Steps

---

For details, refer to the corresponding pages.

**1. Set up the projector.**  
(➔ page 26)



**2. Connect with external devices.**  
(➔ page 29)



**3. Connect the power cord.**  
(➔ page 34)



**4. Switch on the projector.**  
(➔ page 35)



**5. Make initial settings.**  
(➔ page 20)

- Take this step when you switch on the power for the first time after purchasing the projector.



**6. Select the input signal.**  
(➔ page 37)



**7. Adjust the image.**  
(➔ page 37)

# Contents

Be sure to read “Read this first!” from page 2.

<b>Read this first!</b> .....	<b>2</b>	<b>Projecting</b> .....	<b>37</b>
<b>Chapter 1 Preparation</b>		Selecting the input signal.....	37
<b>Precautions for use</b> .....	<b>15</b>	Adjusting the image.....	37
Cautions when transporting.....	15	Viewing 3D images.....	38
Cautions when installing.....	15	Adjustment range by the lens position shift (optical shift).....	39
Security.....	17	<b>Operating with the remote control</b> .....	<b>40</b>
DIGITAL LINK.....	18	Using the AV mute function.....	40
Disposal.....	18	Using the Freeze function.....	40
Cautions on use.....	18	Switching the input.....	41
Accessories.....	19	Using the Automatic setup function.....	41
Optional accessories.....	19	Using the Function button.....	42
<b>Start-up display</b> .....	<b>20</b>	Using the ECO management function.....	42
Initial setting (display language).....	20	Adjusting the volume.....	42
Initial setting (projector setup).....	20	<b>Chapter 4 Settings</b>	
<b>About your projector</b> .....	<b>21</b>	<b>Menu navigation</b> .....	<b>44</b>
Remote control.....	21	Navigating through the menu.....	44
Projector body.....	22	Main menu.....	45
<b>Using the remote control</b> .....	<b>24</b>	Sub-menu.....	46
Inserting and removing the batteries.....	24	<b>[PICTURE] menu</b> .....	<b>49</b>
Setting the remote control ID numbers.....	24	[PICTURE MODE].....	49
<b>Chapter 2 Getting Started</b>		[CONTRAST].....	49
<b>Setting up</b> .....	<b>26</b>	[BRIGHTNESS].....	50
[PROJECTION METHOD] and [COOLING CONDITION].....	26	[COLOR].....	50
Parts for ceiling mount (optional).....	26	[TINT].....	50
Screen size and throw distance.....	27	[COLOR TEMPERATURE].....	50
Adjusting adjustable feet.....	28	[DAYLIGHT VIEW].....	52
<b>Connecting</b> .....	<b>29</b>	[SHARPNESS].....	52
Before connecting.....	29	[NOISE REDUCTION].....	52
Connecting example: AV equipment.....	30	[SYSTEM SELECTOR].....	53
Connecting example: Computers.....	31	sRGB-compliant video.....	53
Connecting example: Twisted-pair-cable transmitter.....	31	<b>[POSITION] menu</b> .....	<b>54</b>
Connecting example: IR transmitter.....	32	[SHIFT].....	54
<b>Chapter 3 Basic Operations</b>		[ASPECT].....	55
<b>Switching on/off the projector</b> .....	<b>34</b>	[ZOOM].....	55
Connecting the power cord.....	34	[CLOCK PHASE].....	56
Power indicator.....	34	[KEystone].....	57
Switching on the projector.....	35	<b>[ADVANCED MENU] menu</b> .....	<b>58</b>
Making adjustments and selections.....	36	[DIGITAL CINEMA REALITY].....	58
Switching off the projector.....	36	[BLANKING].....	58
		[INPUT RESOLUTION].....	59
		[CLAMP POSITION].....	59
		[EDGE BLENDING].....	59
		[FRAME RESPONSE].....	61
		[RASTER POSITION].....	62
		<b>[DISPLAY LANGUAGE] menu</b> .....	<b>63</b>
		Changing the display language.....	63

## Contents

<b>[3D SETTINGS] menu</b> .....	<b>64</b>	<b>[SECURITY] menu</b> .....	<b>95</b>
[3D MODE].....	64	[SECURITY PASSWORD].....	95
[3D SYNC OUTPUT DELAY].....	64	[SECURITY PASSWORD CHANGE].....	95
[LEFT/RIGHT SWAP].....	64	[TEXT DISPLAY].....	96
[3D INPUT FORMAT].....	65	[TEXT CHANGE].....	96
[SAFETY PRECAUTIONS MESSAGE].....	65	[MENU LOCK].....	96
[3D SAFETY PRECAUTIONS].....	66	[MENU LOCK PASSWORD].....	96
<b>[DISPLAY OPTION] menu</b> .....	<b>67</b>	[CONTROL DEVICE SETUP].....	97
[COLOR MATCHING].....	67	<b>[NETWORK] menu</b> .....	<b>98</b>
[SCREEN SETTING] (only for the PT-RW430E series).....	68	[DIGITAL LINK MODE].....	98
[AUTO SIGNAL].....	69	[DIGITAL LINK SETUP].....	98
[AUTO SETUP].....	69	[DIGITAL LINK STATUS].....	99
[COMPUTER IN].....	69	[NETWORK SETUP].....	99
[DVI-I IN].....	70	[NETWORK CONTROL].....	100
[HDMI IN].....	71	[NETWORK STATUS].....	100
[DIGITAL LINK IN].....	71	Network connections.....	100
[ON-SCREEN DISPLAY].....	71	Connecting to a twisted-pair-cable transmitter.....	101
[CLOSED CAPTION SETTING] (NTSC input only).....	73	Accessing from the web browser.....	102
[BACK COLOR].....	74	<b>[DIGITAL LINK] menu</b> .....	<b>117</b>
[STARTUP LOGO].....	74	<b>Chapter 5 Maintenance</b>	
[SUB MEMORY LIST].....	74	<b>Light source/temperature indicator</b> .....	<b>119</b>
[FREEZE].....	75	When an indicator lights up.....	119
[AV MUTE].....	75	<b>Maintenance</b> .....	<b>120</b>
<b>[PROJECTOR SETUP] menu</b> .....	<b>76</b>	Before maintaining the projector.....	120
[PROJECTOR ID].....	76	Maintenance.....	120
[PROJECTION METHOD].....	76	<b>Troubleshooting</b> .....	<b>121</b>
[COOLING CONDITION].....	77	<b>Chapter 6 Appendix</b>	
[HIGH ALTITUDE MODE].....	77	<b>Technical information</b> .....	<b>124</b>
[ECO MANAGEMENT].....	77	PJLink protocol.....	124
[BRIGHTNESS CONTROL].....	79	Control commands via LAN.....	125
[SCHEDULE].....	83	<SERIAL IN> terminal.....	127
[INITIAL STARTUP].....	85	Menu lock password.....	129
[STARTUP INPUT SELECT].....	85	List of compatible signals.....	130
[DIGITAL LINK INPUT].....	85	<b>Specifications</b> .....	<b>133</b>
[RS-232C].....	86	<b>Dimensions</b> .....	<b>135</b>
[FUNCTION BUTTON].....	87	<b>Ceiling mount bracket safeguards</b> .....	<b>136</b>
[AUDIO SETTING].....	88	<b>Index</b> .....	<b>137</b>
[STATUS].....	89		
[DATE AND TIME].....	90		
[SAVE ALL USER DATA].....	90		
[LOAD ALL USER DATA].....	91		
[INITIALIZE].....	91		
[SERVICE PASSWORD].....	91		
<b>[TEST PATTERN] menu</b> .....	<b>92</b>		
[TEST PATTERN].....	92		
<b>[SIGNAL LIST] menu</b> .....	<b>93</b>		
Registering new signals.....	93		
Renaming the registered signal.....	93		
Deleting the registered signal.....	94		

# Chapter 1 Preparation

---

This chapter describes things you need to know or check before using the projector.

# Precautions for use

## Cautions when transporting

- When transporting the projector, hold it securely by its bottom and avoid excessive vibration and impacts. They may damage the internal components and result in malfunctions.
- Do not transport the projector with the adjustable feet extended. Doing so may damage the adjustable feet.

## Cautions when installing

### ■ Do not set up the projector outdoors.

The projector is designed for indoor use only.

### ■ Do not set up the projector in the following locations.

- Places where vibration and impacts occur such as in a car or vehicle: Doing so may cause damage to internal components or malfunction.
- Near the exhaust of an air conditioner: Depending on the conditions of use, the screen may fluctuate in rare cases due to the hot air from the air exhaust port or the heated or cooled air. Make sure that the exhaust from the projector or other equipment, or the air from the air conditioner does not blow toward the front of the projector.
- Near lights (studio lamps, etc.) and other locations with severe temperature fluctuations (when using at a place lower than 1 400 m (4 593') above sea level: operating temperature of 0 °C (32 °F) to 45 °C (113 °F), when using at a place of 1 400 m (4 593') to 2 700 m (8 858') above sea level: operating temperature of 0 °C (32 °F) to 40 °C (104 °F)): The outer case may be deformed by heat, which may result in malfunctions.
- Near high-voltage power lines or near motors: Doing so may interfere with the operation of the projector.
- Place where there is high-power laser equipment: Directing a laser beam onto the lens surface causes damage to the DLP chips.

### ■ Be sure to ask a specialized technician or your dealer when installing the projector to a ceiling.

The optional ceiling mount bracket is required.

Model No.: ET-PKR100H (for high ceilings), ET-PKR100S (for low ceilings), ET-PKR100P (for portrait)

### ■ Ask a qualified technician or your dealer to install the cable wiring for DIGITAL LINK connection.

Image and sound may be disrupted if cable transmission characteristics cannot be obtained due to inadequate installation.

### ■ The projector may not work properly due to strong radio wave from the broadcast station or the radio.

If there is any facility or equipment, which outputs strong radio wave, near the installation location, install the projector at a location sufficiently far from the source of the radio wave. Or, wrap the LAN cable connected to the <DIGITAL LINK/LAN> terminal by using a piece of metal foil or a metal pipe, of which is grounded at both ends.

### ■ Lens focus

The high clarity projection lens is thermally affected by the light from the light source, making the focus unstable in the period just after switching on the power. Wait at least 30 minutes with the image projected before adjusting the lens focus.

### ■ Make sure to set [HIGH ALTITUDE MODE] to [ON] when using the projector at elevations between 1 400 m (4 593') and 2 700 m (8 858') above sea level.

Failure to do so may shorten the life of the components and result in malfunctions.

### ■ Make sure to set [HIGH ALTITUDE MODE] to [OFF] when using the projector at elevations lower than 1 400 m (4 593') above sea level.

Failure to do so may shorten the life of the components and result in malfunctions.

### ■ Do not install the projector at high altitudes of 2 700 m (8 858') or higher above sea level.

Doing so may shorten the life of the components and result in malfunctions.

■ **When installing and using the projector at an angle that exceeds 30° vertically, set [COOLING CONDITION] (➔ page 77).**

Failure to observe this may shorten the life of the components or result in malfunctions.

■ **Do not use the projector with the connecting terminal side up.**

Using the projector at an angle that exceeds the available angle of 210° may result in malfunctions. If setting up the projector at an angle that exceeds 210° is required, consult your dealer.

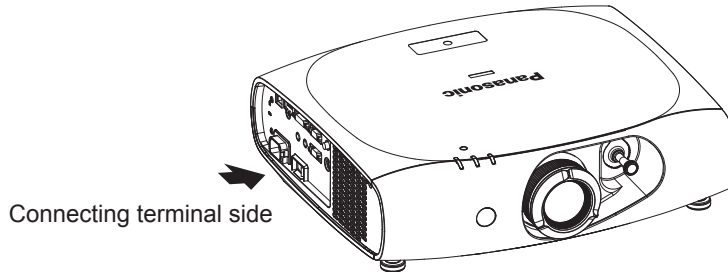

● **Available angle in horizontal direction**

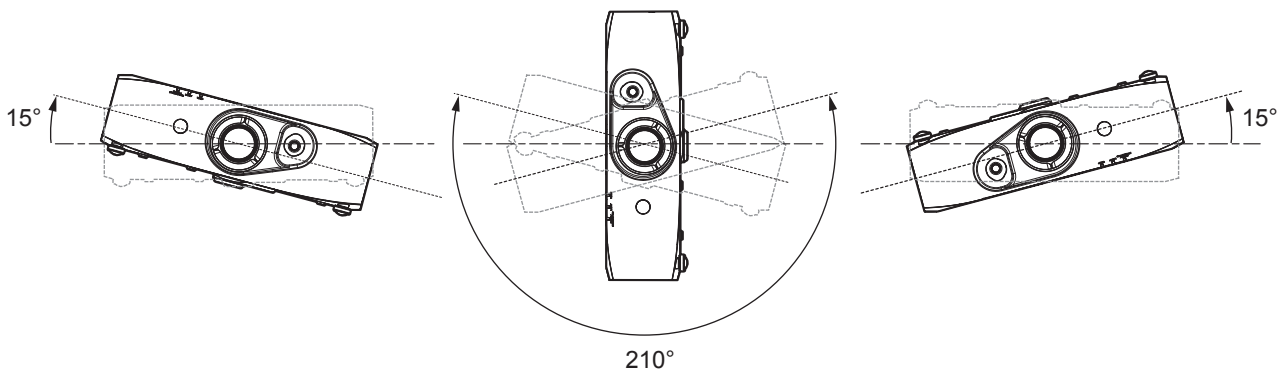

● **Available angle in vertical direction for the portrait setting**

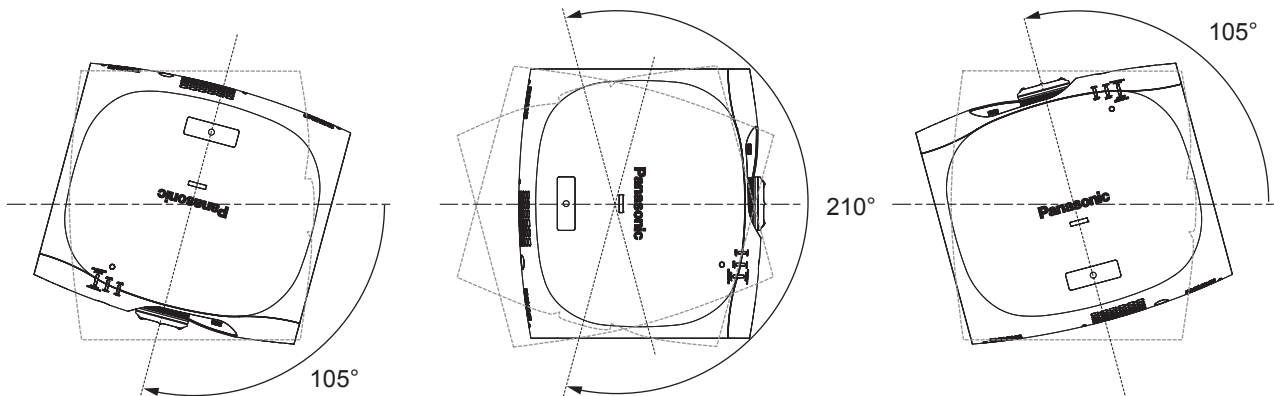

■ **For the portrait setting, set the projector directly facing the screen.**

- If the projector is vertically installed in the portrait setting, the keystone correction for the vertical tilt is not available. In this case, the keystone correction works for the horizontal tilt.



## ■ Cautions when setting up the projector

- To install and use the projector via a method that does not use the adjustable feet in a floor standing installation, fix the projector using the four screw holes for ceiling mounting (as shown in the figure).  
(Screw diameter: M4, tapping depth inside the set: 10 mm (13/32"), torque:  $1.25 \pm 0.2$  N·m)  
Make a clearance of at least 12 mm (15/32") between the projector bottom and setting surface by inserting spacers (metallic) etc. between them.
- Use the adjustable feet only for the floor standing installation and for adjusting the angle. Using them for other purposes may damage the set.

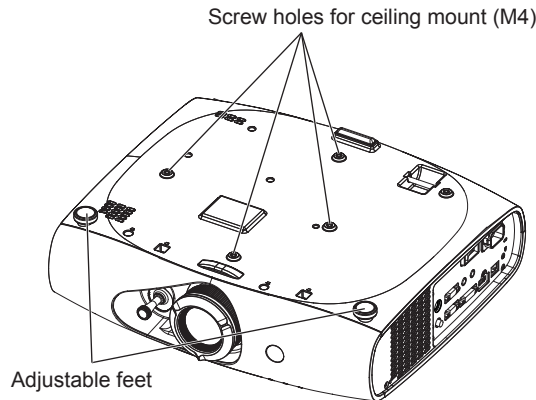

The positions of screw holes for ceiling mount and adjustable feet

- Do not stack projectors on top of each other.
- Do not block the ventilation ports (intake and exhaust) of the projector.
- Prevent hot and cool air from the air conditioning system to blow directly to the ventilation ports (intake and exhaust) of the projector.

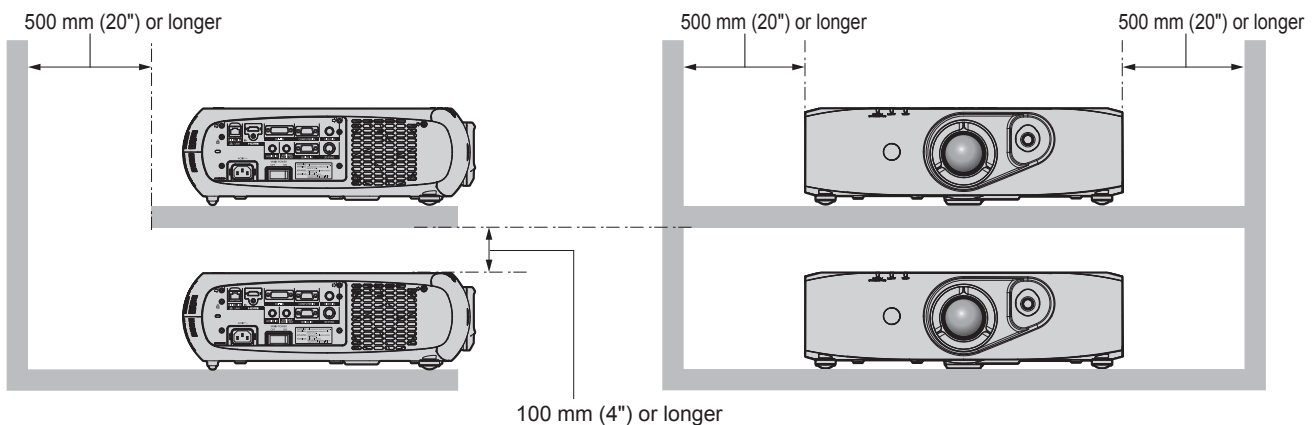
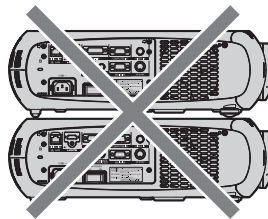

- Do not install the projector in a confined space.  
When it is necessary to install the projector in a confined space, install the air conditioning or ventilation separately. Exhaust heat may accumulate when the ventilation is not enough, triggering the protection circuit of the projector.

## Security

When using this product, take safety measures against the following incidents.

- Personal information being leaked via this product
- Unauthorized operation of this product by a malicious third party
- Interfering or stopping of this product by a malicious third party

Take sufficient security measures. (➔ pages 95, 113)

- Make your password difficult to guess as much as possible.

- Change your password periodically.
- Panasonic Corporation or its affiliate companies will never ask for your password directly. Do not divulge your password in case you receive such inquiries.
- The connecting network must be secured by a firewall, etc.
- Set a password for the web control and restrict the users who can log in.

### DIGITAL LINK

---

“DIGITAL LINK” is a technology that uses a twisted-pair-cable to transmit video, audio, Ethernet, and serial control signals. The projector supports the optional digital interface box (Model No.: ET-YFB100G), and the “XTP transmitter” of Extron Electronics. For twisted-pair-cable transmitter of other manufacturers of which the operation has been verified with the DIGITAL LINK compatible projector, refer to Panasonic website (<http://panasonic.net/avc/projector/>). Note that the verification for devices of other manufacturers has been made for the items set by Panasonic Corporation, and not all the operations have been verified. For operation or performance problems caused by the devices of other manufacturers, contact the respective manufacturers.

### Disposal

---

To dispose of the product, ask your local authorities or dealer for correct methods of disposal.

### Cautions on use

---

#### ■ To get a good picture quality

- In order to view a beautiful image in higher contrast, prepare an appropriate environment. Draw curtains or blinds over windows and turn off any lights near the screen to prevent outside light or light from indoor lamps from shining onto the screen.
- The high clarity projection lens is thermally affected by the light from the light source, making the focus unstable in the period just after switching on the power. The focus stabilizes when an image is projected continuously for 30 minutes or more.

#### ■ Do not touch the surface of the projection lens with your bare hands.

If the surface of the projection lens becomes dirty from fingerprints or anything else, this will be magnified and projected onto the screen.

#### ■ DLP chips

- The DLP chips are precision-made. Note that in rare cases, pixels of high precision could be missing or always lit. Note that such phenomena does not indicate malfunction.
- Directing a high-power laser beam onto the lens surface can damage the DLP chips.

#### ■ Light source

The light source of the projector uses LED and lasers, and has the following characteristics.

- The luminance of the light source will decrease by duration of usage.  
The usage time until when the luminance of the light source decreases by half is approximately 20 000 hours. 20 000 hours is the estimated duration, and it varies depending on individual differences and usage conditions.  
If the light source goes off or the brightness reduces noticeably, ask your dealer about replacement of the light source unit.

#### ■ Computer and external device connections

- When connecting a computer or an external device, use power cords and shielded cables following instructions in this manual.
- When inputting digital signals to the DVI-I terminal, use a commercially available cable with a ferrite core.

#### ■ Viewing 3D images

The projector can display 3D image signals that are input through various systems such as “frame packing” and “side by side”. You need to prepare external devices for viewing 3D images (such as 3D eyewear, video signal output devices) which are compatible with your 3D system. For connections of the projector and external devices, see the instruction manuals of external devices you use. Connections vary depending on your 3D system.

Refer to “List of 3D compatible signals” (➡ page 132) for the types of 3D video signals that can be used with the projector.

## Accessories

Make sure that the following accessories are provided with your projector. Numbers enclosed in < > show the number of accessories.

**Wireless remote control unit <1>**  
(N2QAYB000812)

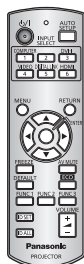

**CD-ROM <1>**  
(TXFQB02VLF2)

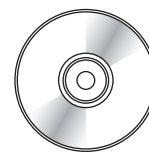

**Power cord <1>**  
(TXFSX01RXQZ)

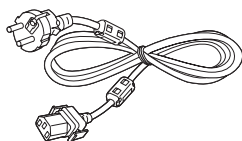

**AA/R6 or AA/LR6 battery <2>**

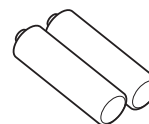

(For remote control unit)

### Attention

- After unpacking the projector, discard the power cord cap and packaging material properly.
- Do not use other power cords other than the supplied power cord.
- For missing accessories, consult your dealer.
- Store small parts in an appropriate manner, and keep them away from small children.

### Note

- The model numbers of accessories are subject to change without prior notice.

## Contents of the supplied CD-ROM

The contents of the supplied CD-ROM are as follows.

Instruction/list (PDF)	Operating Instructions – Functional Manual	
	Multi Projector Monitoring & Control Software Operation Manual	
	Logo Transfer Software Operating Instructions	
	List of Compatible Projector Models	This is a list of projectors that are compatible with the software contained in the CD-ROM and their restrictions.
Software	Multi Projector Monitoring & Control Software (Windows)	This software allows you to monitor and control multiple projectors connected to the LAN.
	Logo Transfer Software (Windows)	This software allows you to create original images, such as company logos to be displayed when projection starts, and transfer them to the projector.

## Optional accessories

Optional accessories (product name)	Model No.
Ceiling mount bracket	ET-PKR100H (for high ceilings), ET-PKR100S (for low ceilings), ET-PKR100P (for portrait)
Digital interface box	ET-YFB100G

### Note

- The model numbers of optional accessories are subject to change without prior notice.

# Start-up display

The initial setting screen is displayed when the projector is switched on for the first time after purchase as well as when [ALL USER DATA] in the [PROJECTOR SETUP] menu → [INITIALIZE] is executed. Set them in accordance with circumstances. In other occasions, you can change the settings by menu operations.

## Note

- When the projector is used for the first time, you may be required to adjust the lens zoom ring and focus ring of the projector (➔ page 22) to display the menu screen clearly. Refer to “Adjusting the image” (➔ page 37) for details.

## Initial setting (display language)

Select the language to show on the screen.

- Press ▲▼ to select the display language.

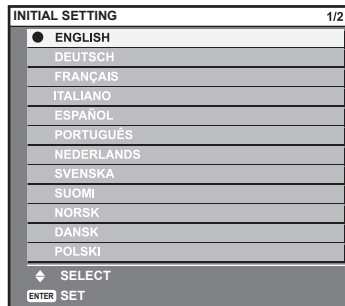

- Press the <ENTER> button to proceed to the initial setting.

## Initial setting (projector setup)

Set each item.

- Press ▲▼ to select an item.
- Press ◀▶ to switch the setting.

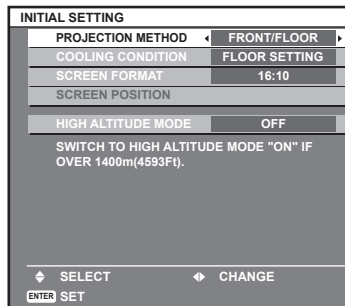

- [PROJECTION METHOD] and [COOLING CONDITION] (➔ page 26)
- [SCREEN FORMAT] (only for the PT-RW430E series)  
Select [16:10] or [16:9] based on the screen in use.
- [SCREEN POSITION] (only for the PT-RW430E series)  
The vertical position can be adjusted between -40 and 40 only when [SCREEN FORMAT] is set to [16:9].
- [HIGH ALTITUDE MODE]  
Set to [ON] when using the projector at high altitudes between 1 400 m (4 593') and 2 700 m (8 858') above sea level.

- Press the <ENTER> button.

- Fix the setting value to complete the initial setting.

## Note

- If you press the <RETURN> button on the initial setting (projector setup) screen, you can go back to the initial setting (display language) screen.
- [SCREEN FORMAT] and [SCREEN POSITION] are available only for the PT-RW430E series.
- To continue operations after completed the initial settings (projector setup), refer to “Selecting the input signal” (➔ page 37).
- By default, the time zone of the projector is set to +09:00 (Japan and Korean Standard Time). Change the setting in the [PROJECTOR SETUP] menu → [DATE AND TIME] → [TIME ZONE] to the time zone of the region where you use the projector.

# About your projector

## Remote control

### ■ Front

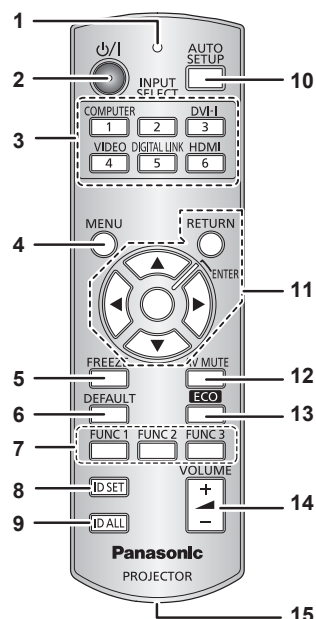

### ■ Top

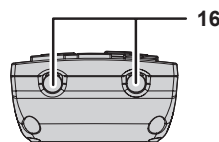

Attach a strap according to usage condition.

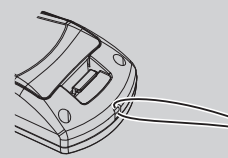

#### 1 Remote control indicator

Flashes if any button in the remote control is pressed.

#### 2 Power <P> button

Sets the projector to the standby mode when the <MAIN POWER> switch on the projector is set to <ON>. Also sets the projector in projection mode when the power is switched off (standby mode).

#### 3 Input selection (<COMPUTER>, <DVI-I>, <VIDEO>, <DIGITAL LINK>, <HDMI>) buttons

Switches the input signal to project. (➔ page 41)  
Also used to set the ID number of the remote control and security password. (➔ page 24)

#### 4 <MENU> button

Displays the main menu. (➔ page 44)

#### 5 <FREEZE> button

Used to pause a video and mute the audio. (➔ page 40)

#### 6 <DEFAULT> button

Resets the content of the sub-menu to the factory default. (➔ page 45)

#### 7 <FUNC1> - <FUNC3> buttons

Assigns a frequently used operation as a shortcut button. (➔ page 42)

#### 8 <ID SET> button

Sets the ID number of the remote control to use for a system using multiple projectors. (➔ page 24)

#### 9 <ID ALL> button

Used to simultaneously control all the projectors with one remote control for a system using multiple projectors. (➔ page 24)

#### 10 <AUTO SETUP> button

Automatically adjusts the image display position while projecting the image.  
[PROGRESS] is displayed on the screen while adjusting automatically. (➔ page 41)

#### 11 ▲▼◀▶ buttons/<RETURN> button/<ENTER> button

Used to navigate through the menu screen.  
Also used to enter a password in [SECURITY] or enter characters.

#### 12 <AV MUTE> button

Used to temporarily turn off the audio and video. (➔ page 40)

#### 13 <ECO> button

Displays the setting screen related to ECO management. (➔ page 42)

#### 14 <VOLUME+>/<VOLUME-> button

Adjusts the audio output volume. (➔ page 42)

#### 15 Strap hole

#### 16 Remote control signal transmitter

### Attention

- Do not drop the remote control.
- Avoid contact with liquids or moisture.
- Do not attempt to modify or disassemble the remote control.
- When attaching the strap to the remote control, hold the strap to prevent it from swinging.

**Note**

- The remote control can be used within a distance of about 15 m (49'2") if pointed directly at the remote control receiver. The remote control can control at angles of up to  $\pm 15^\circ$  vertically and  $\pm 30^\circ$  horizontally, but the effective control range may be reduced.
- If there are any obstacles between the remote control and the remote control signal receiver, the remote control may not operate properly.
- The signal will be reflected off the screen. However, the operating range may be limited from light reflection loss due to the screen material.
- If the remote control signal receiver directly receives strong light, such as fluorescent light, the remote control may not operate properly. Use it in a place distant from the light source.
- The power indicator <ON (G)/STANDBY (R)> will flash if the projector receives a remote control signal.

**Projector body**

■ **Front**

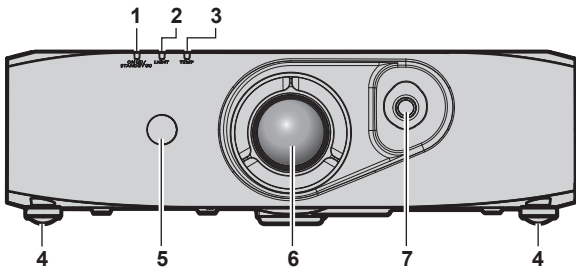

■ **Side**

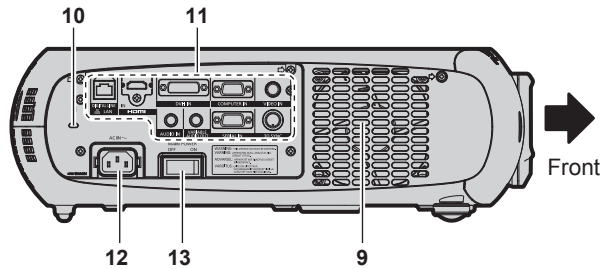

■ **Rear**

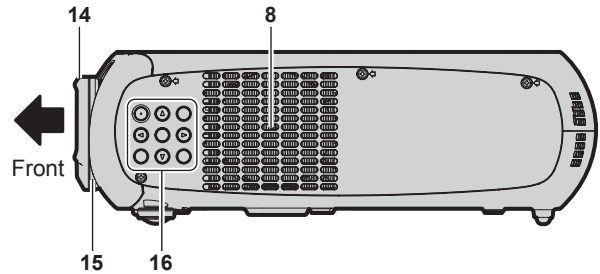
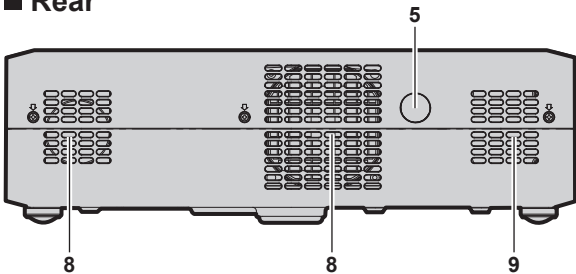

■ **Bottom**

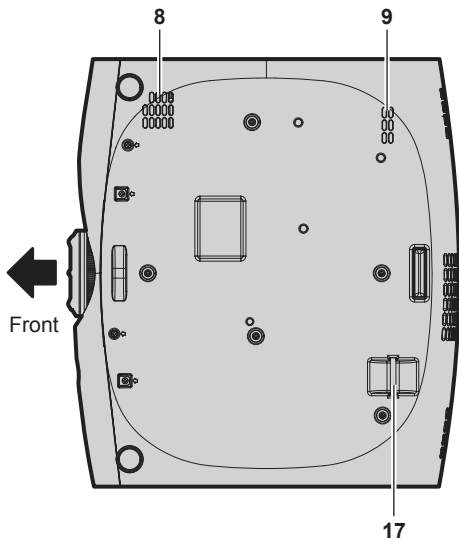

- 1 Power indicator <ON (G)/STANDBY (R)>**  
Displays the status of the power.
- 2 Light source indicator <LIGHT>**  
Displays the status of the light source.

- 3 Temperature indicator <TEMP>**  
Displays the internal temperature status.
- 4 Adjustable feet**  
Adjusts the projection angle.
- 5 Remote control signal receiver**
- 6 Projection lens**
- 7 Lens shift lever**  
Adjusts the projection position.
- 8 Air intake port**
- 9 Air exhaust port**
- 10 Security slot**  
This security slot is compatible with the Kensington security cables.
- 11 Connecting terminals (⇒ page 23)**
- 12 <AC IN> terminal**  
Connect the supplied power cord.
- 13 <MAIN POWER> switch**  
Turns on/off the main power.
- 14 Focus ring**  
Adjusts the focus.
- 15 Zoom ring**  
Adjusts the zoom.
- 16 Control panel (⇒ page 23)**
- 17 Burglar hook port**  
Attaches a burglar prevention cable, etc.

■ Control panel

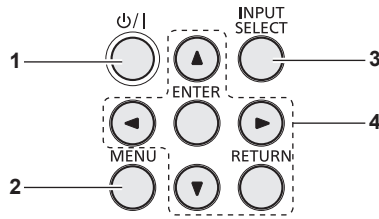

1 **Power <math>\phi/I</math> button**

Sets the projector to the state where the projector is switched off (standby mode) when the <MAIN POWER> switch on the projector is set to <ON> and in projection mode. Also sets the projector in projection mode when the power is switched off (standby mode).

2 **<MENU> button**

Displays the main menu. (➔ page 44)

3 **<INPUT SELECT> button**

Switches the input signal to project. (➔ page 41)

4 **▲▼◀▶ buttons/<RETURN> button/<ENTER> button**

Used to navigate through the menu screen.

Also used to enter a password in [SECURITY] or enter characters.

■ Connecting terminals

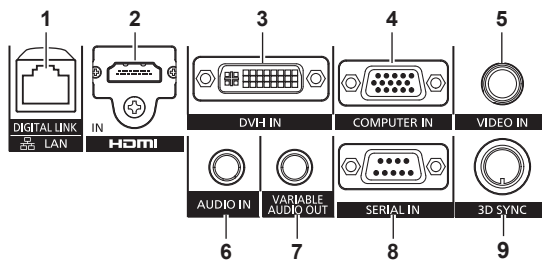

1 **<DIGITAL LINK/LAN> terminal**

This is the LAN terminal to connect to the network. This is also used when connecting an audio and video signal sending device via the LAN terminal.

2 **<HDMI IN> terminal**

This is the terminal to input HDMI signals.

3 **<DVI-I IN> terminal**

This is the terminal to input DVI-D and DVI-A signals (RGB signal or  $Y C_B C_R / Y P_B P_R$ ).

4 **<COMPUTER IN> terminal**

This is the terminal to input RGB or  $Y C_B C_R / Y P_B P_R$  signals from a computer.

5 **<VIDEO IN> terminal**

This is the terminal to input video signals.

6 **<AUDIO IN> terminal**

This is the terminal to input audio signals.

7 **<VARIABLE AUDIO OUT> terminal**

This is the terminal to output audio signals input to the projector.

8 **<SERIAL IN> terminal**

This is the RS-232C compatible terminal to externally control the projector by connecting a computer.

9 **<3D SYNC> terminal**

This terminal is used to connect an IR transmitter to the projector.

**Attention**

- When a LAN cable is directly connected to the projector, the network connection must be made indoors.

# Using the remote control

## Inserting and removing the batteries

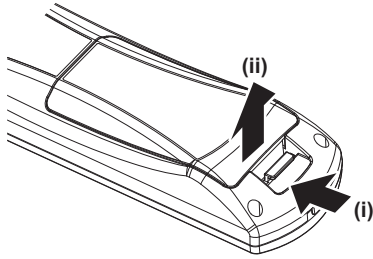

Fig. 1

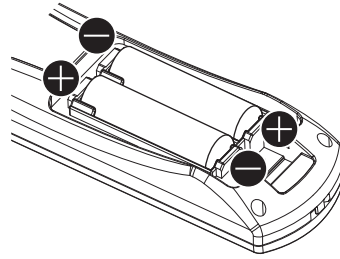

Fig. 2

- 1) **Open the cover. (Fig. 1)**
- 2) **Insert the batteries and close the cover (insert the  $\ominus$  side first). (Fig. 2)**
  - When removing the batteries, perform the steps in reverse order.

## Setting the remote control ID numbers

When you use the system with multiple projectors, you can operate all the projectors simultaneously or each projector individually using single remote control, if a unique ID number is assigned to each projector.

After setting the ID number of the projector, set same ID number on the remote control.

**The factory default ID number of the projector is set to [ALL]. When using a single projector, press the <ID ALL> button on the remote control. Also, you can control a projector by pressing the <ID ALL> button on the remote control even if you do not know the projector ID.**

### How to set

- 1) **Press the <ID SET> button on the remote control.**
- 2) **Within five seconds, press the one-digit ID number set on the projector using the number (<1> - <6>) buttons.**
  - If you press the <ID ALL> button, you can control the projectors regardless of the ID number setting of the projector.

### Attention

- Since the ID number of the remote control can be set without the projector, do not press the <ID SET> button carelessly. If the <ID SET> button is pressed and no number (<1> - <6>) buttons are pressed within five seconds, the ID number returns to its original value before the <ID SET> button was pressed.
- The ID number set on the remote control will be stored unless it is set again. However, it will be erased if the remote control is left with dead batteries. Set the same ID number again when the batteries are replaced.

### Note

- Set the ID number of the projector from the [PROJECTOR SETUP] menu → [PROJECTOR ID].



# Chapter 2 **Getting Started**

---

This chapter describes things you need to do before using the projector such as the setup and connections.

# Setting up

## [PROJECTION METHOD] and [COOLING CONDITION]

There are six ways to set up the projector. Set the [PROJECTOR SETUP] menu → [PROJECTION METHOD] and [COOLING CONDITION] depending on the environment. Also set [COOLING CONDITION] correctly. Using with incorrect settings may shorten the life of light source.

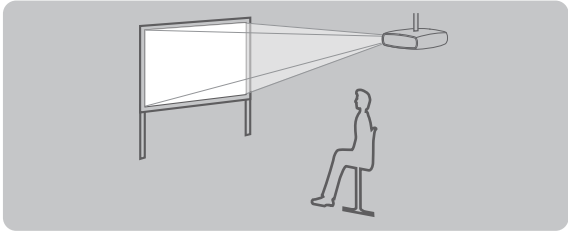
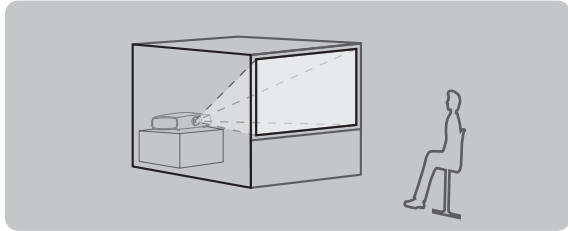
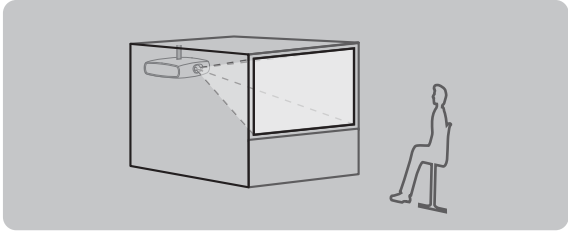
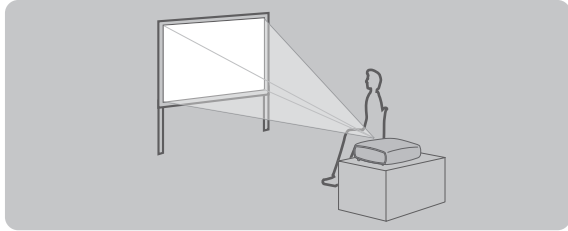
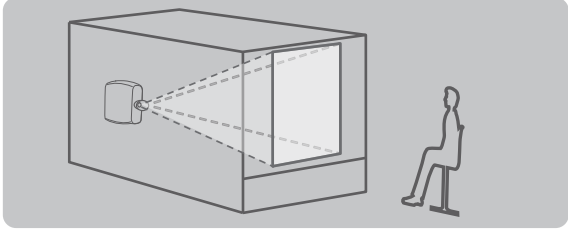
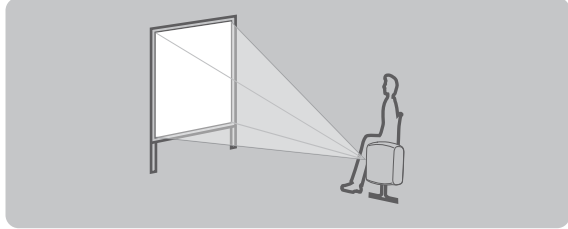
<b>Mounting on the ceiling and projecting forward</b> 		<b>Setting on a desk/floor and projecting from rear</b> (Using the translucent screen) 	
<b>Menu item*1</b>	<b>Method</b>	<b>Menu item*1</b>	<b>Method</b>
[PROJECTION METHOD]	[FRONT/CEILING]	[PROJECTION METHOD]	[REAR/FLOOR]
[COOLING CONDITION]	[CEILING SETTING]	[COOLING CONDITION]	[FLOOR SETTING]
<b>Mounting on the ceiling and projecting from rear</b> (Using the translucent screen) 		<b>Setting on a desk/floor and projecting forward</b> 	
<b>Menu item*1</b>	<b>Method</b>	<b>Menu item*1</b>	<b>Method</b>
[PROJECTION METHOD]	[REAR/CEILING]	[PROJECTION METHOD]	[FRONT/FLOOR]
[COOLING CONDITION]	[CEILING SETTING]	[COOLING CONDITION]	[FLOOR SETTING]
<b>Portrait setting and projecting from the rear</b> (Using the translucent screen) 		<b>Portrait setting and projecting forward</b> 	
<b>Menu item*1</b>	<b>Method</b>	<b>Menu item*1</b>	<b>Method</b>
[PROJECTION METHOD]	[REAR/FLOOR]	[PROJECTION METHOD]	[FRONT/FLOOR]
[COOLING CONDITION]	[PORTRAIT SETTING]	[COOLING CONDITION]	[PORTRAIT SETTING]

\*1 For menu item details, refer to the [PROJECTOR SETUP] menu → [PROJECTION METHOD] (➔ page 76) and [COOLING CONDITION] (➔ page 77).

## Parts for ceiling mount (optional)

You can install the projector using the optional ceiling mount bracket (Model No.: ET-PKR100H (for high ceilings), ET-PKR100S (for low ceilings), or ET-PKR100P (for portrait)).

- Use only the ceiling mount brackets specified for this projector.
- Refer to the installation manual for the ceiling mount bracket when installing and setting up the bracket and the projector.

### Attention

- To ensure projector performance and security, installation of the ceiling mount bracket must be carried out by your dealer or a qualified technician.

## Screen size and throw distance

Refer to the following figures and table describing projection distances to install the projector. Image size and image position can be adjusted in accordance with the screen size and screen position.

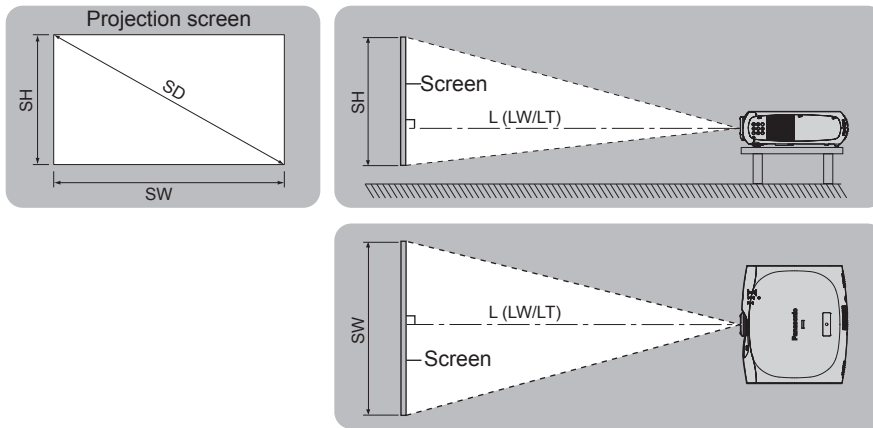

L (LW/LT)*1	Projection distance (m)
SH	Image height (m)
SW	Image width (m)
SD	Image diagonal size (m)

\*1 LW: Minimum projection distance  
 LT: Maximum projection distance

### Attention

- Before setting up, read “Precautions for use” (➔ page 15).
- Do not use the projector and the high-powered laser equipment in the same room.
- The DLP chips can be damaged if a laser beam hits the lens surface.

### Projection distance

#### For the PT-RZ470E series

(The dimensions of the following table contain a slight error.)

(Unit: m)

Projection screen size	4:3 aspect ratio		16:9 aspect ratio		16:10 aspect ratio	
	Min. projection distance (LW)	Max. projection distance (LT)	Min. projection distance (LW)	Max. projection distance (LT)	Min. projection distance (LW)	Max. projection distance (LT)
1.02 (40")	1.55 (5.10')	3.16 (10.39')	1.26 (4.13')	2.58 (8.47')	1.36 (4.48')	2.79 (9.16')
1.27 (50")	1.95 (6.42')	3.97 (13.02')	1.59 (5.21')	3.23 (10.62')	1.72 (5.65')	3.50 (11.49')
1.52 (60")	2.36 (7.74')	4.77 (15.66')	1.91 (6.29')	3.89 (12.77')	2.07 (6.82')	4.21 (13.81')
1.78 (70")	2.76 (9.06')	5.57 (18.29')	2.24 (7.37')	4.54 (14.92')	2.43 (7.99')	4.92 (16.14')
2.03 (80")	3.16 (10.39')	6.37 (20.92')	2.57 (8.45')	5.20 (17.07')	2.79 (9.15')	5.62 (18.46')
2.29 (90")	3.56 (11.71')	7.18 (23.55')	2.90 (9.53')	5.85 (19.22')	3.14 (10.32')	6.33 (20.79')
2.54 (100")	3.97 (13.03')	7.98 (26.19')	3.23 (10.61')	6.51 (21.37')	3.50 (11.49')	7.04 (23.11')
3.05 (120")	4.77 (15.67')	9.58 (31.45')	3.89 (12.77')	7.82 (25.67')	4.21 (13.82')	8.46 (27.76')
3.81 (150")	5.98 (19.63')	11.99 (39.35')	4.88 (16.01')	9.79 (32.13')	5.28 (17.32')	10.59 (34.74')
5.08 (200")	7.99 (26.24')	16.00 (52.51')	6.52 (21.41')	13.07 (42.88')	7.05 (23.16')	14.13 (46.37')
6.35 (250")	10.01 (32.85')	20.01 (65.67')	8.17 (26.80')	16.34 (53.63')	8.83 (28.99')	17.67 (57.99')
7.62 (300")	12.02 (39.45')	24.03 (78.83')	9.81 (32.20')	19.62 (64.39')	10.61 (34.83')	21.22 (69.62')

**For the PT-RW430E series**

(The dimensions of the following table contain a slight error.)

(Unit: m)

Projection screen size Diagonal (SD)	4:3 aspect ratio		16:9 aspect ratio		16:10 aspect ratio	
	Min. projection distance (LW)	Max. projection distance (LT)	Min. projection distance (LW)	Max. projection distance (LT)	Min. projection distance (LW)	Max. projection distance (LT)
1.02 (40")	1.46 (4.81')	2.99 (9.81')	1.32 (4.53')	2.71 (8.90')	1.29 (4.23')	2.63 (8.65')
1.27 (50")	1.84 (6.06')	3.75 (12.30')	1.67 (5.49')	3.40 (11.15')	1.62 (5.33')	3.30 (10.85')
1.52 (60")	2.22 (7.31')	4.50 (14.79')	2.01 (6.62')	4.08 (13.41')	1.96 (6.43')	3.97 (13.05')
1.78 (70")	2.60 (8.56')	5.26 (17.27')	2.36 (7.75')	4.77 (15.67')	2.29 (7.54')	4.64 (15.24')
2.03 (80")	2.99 (9.81')	6.02 (19.76')	2.71 (8.89')	5.46 (17.93')	2.63 (8.64')	5.31 (17.44')
2.29 (90")	3.37 (11.06')	6.78 (22.25')	3.05 (10.02')	6.15 (20.19')	2.97 (9.74')	5.98 (19.64')
2.54 (100")	3.75 (12.30')	7.54 (24.74')	3.40 (11.15')	6.84 (22.45')	3.30 (10.85')	6.65 (21.83')
3.05 (120")	4.51 (14.80')	9.05 (29.71')	4.09 (13.42')	8.21 (26.96')	3.98 (13.05')	7.99 (26.23')
3.81 (150")	5.65 (18.55')	11.33 (37.18')	5.12 (16.82')	10.28 (33.74')	4.98 (16.36')	10.00 (32.82')
5.08 (200")	7.55 (24.79')	15.12 (49.61')	6.85 (22.49')	13.72 (45.03')	6.66 (21.88')	13.35 (43.81')
6.35 (250")	9.46 (31.03')	18.91 (62.05')	8.58 (28.16')	17.16 (56.32')	8.35 (27.39')	16.70 (54.80')
7.62 (300")	11.36 (37.28')	22.70 (74.49')	10.31 (33.83')	20.61 (67.61')	10.03 (32.91')	20.05 (65.78')

**Projection distance formulas**

To use a screen size not listed in this manual, check the screen size SD (m) and use the following formula to calculate projection distance. Unit for calculations: m (The values of the following calculation results contain a slight error.)

**For the PT-RZ470E series**

	4:3 aspect ratio	16:9 aspect ratio	16:10 aspect ratio
Screen size Height (SH)	= SD x 0.6	= SD x 0.490	= SD x 0.530
Screen size Width (SW)	= SD x 0.8	= SD x 0.872	= SD x 0.848
Min. projection distance (LW)	= 1.5854 x SD - 0.0544	= 1.2955 x SD - 0.0544	= 1.4004 x SD - 0.0544
Max. projection distance (LT)	= 3.1589 x SD - 0.0408	= 2.5812 x SD - 0.0408	= 2.7904 x SD - 0.0408

**For the PT-RW430E series**

	4:3 aspect ratio	16:9 aspect ratio	16:10 aspect ratio
Screen size Height (SH)	= SD x 0.6	= SD x 0.490	= SD x 0.530
Screen size Width (SW)	= SD x 0.8	= SD x 0.872	= SD x 0.848
Min. projection distance (LW)	= 1.4984 x SD - 0.0542	= 1.3604 x SD - 0.0542	= 1.3236 x SD - 0.0542
Max. projection distance (LT)	= 2.9851 x SD - 0.0407	= 2.7102 x SD - 0.0407	= 2.6369 x SD - 0.0407

**Adjusting adjustable feet**

Install the projector on a flat surface so that the front of the projector is parallel to the screen surface and the projection screen is rectangular. If the screen is tilted downward, the projection screen can be adjusted to be rectangular by adjusting the adjustable feet. The adjustable feet can also be used to adjust the projector to be level when it is tilted in a horizontal direction.

Extend the adjustable feet by rotating in the direction shown in the figure and retract by rotating in the opposite direction.

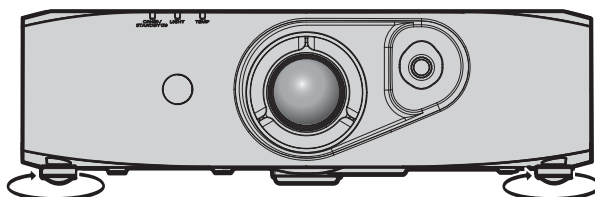

**Adjustable amount**

Front adjustable feet: Approx. 12 mm (15/32")

**Attention**

- Be careful not to block the intake/exhaust with your hands or any objects when adjusting the adjustable feet when the light source is on. (→ page 22)
- When there is trapezoidal distortion, execute the [POSITION] menu → [KEYSTONE].

# Connecting

## Before connecting

- Before connecting, carefully read the operating instructions for the external device to be connected.
- Turn off the power of all devices before connecting cables.
- Take note of the following points before connecting the cables. Failure to do so may result in malfunctions.
  - When connecting a cable to a device connected to the projector or the projector itself, touch any nearby metallic objects to eliminate static electricity from your body before performing work.
  - Do not use unnecessarily long cables to connect to a device connected to the projector or to the projector body. The longer the cable, the more it is susceptible to noise. Since using a cable while it is wound makes it act like an antenna, it is more susceptible to noise.
  - When connecting cables, connect GND first, then insert the connecting terminal of the connecting device in a straight manner.
- Acquire any connection cable necessary to connect the external device to the system that is either not supplied with the device or not available as an option.
- Video signals containing too much jitter may cause the images on the screen to randomly wobble or wafture. In this case, a time base corrector (TBC) must be connected.
- The projector accepts video signals, analog RGB signals (synchronous signals are TTL level), and digital signals.
- Some computer models are not compatible with the projector.
- Use a cable compensator when you connect devices to the projector using long cables. Otherwise the image may not display properly.
- Refer to “List of compatible signals” (➔ page 130) for the types of video signals that can be used with the projector.

## <COMPUTER IN> terminal pin assignments and signal names

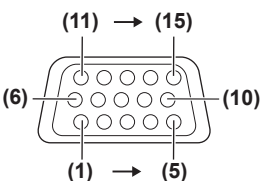
Outside view	Pin No.	Signal name	Pin No.	Signal name
	(1)	R/P <sub>R</sub>	(9)	—
	(2)	G/Y	(10)	GND
	(3)	B/P <sub>B</sub>	(11)	GND
	(4)	—	(12)	DDC data
	(5)	GND	(13)	SYNC/HD
	(6)	GND	(14)	VD
	(7)	GND	(15)	DDC clock
	(8)	GND		

## <DVI-I IN> terminal pin assignments and signal names

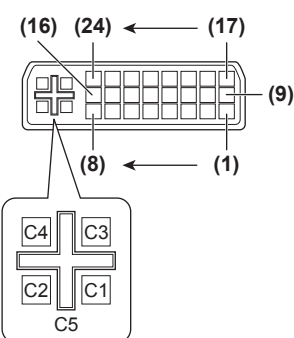
Outside view	Pin No.	Signal name	Pin No.	Signal name
	(1)	T.M.D.S data 2-	(16)	Hot plug detection
	(2)	T.M.D.S data 2+	(17)	T.M.D.S data 0-
	(3)	T.M.D.S data 2/4 shield	(18)	T.M.D.S data 0+
	(4)	—	(19)	T.M.D.S data 0/5 shield
	(5)	—	(20)	—
	(6)	DDC clock	(21)	—
	(7)	DDC data	(22)	T.M.D.S clock shield
	(8)	Analog VD	(23)	T.M.D.S clock+
	(9)	T.M.D.S data 1-	(24)	T.M.D.S clock-
	(10)	T.M.D.S data 1+	C1	Analog R/P <sub>R</sub>
	(11)	T.M.D.S data 1/3 shield	C2	Analog G/G SYNC/Y
	(12)	—	C3	Analog B/P <sub>B</sub>
	(13)	—	C4	Analog HD/SYNC
	(14)	+5 V	C5	Analog GND
	(15)	GND		

<HDMI IN> terminal pin assignments and signal names

Outside view	Pin No.	Signal name	Pin No.	Signal name
<p>Even-numbered pins of (2) to (18)</p> <p>Odd-numbered pins of (1) to (19)</p>	(1)	T.M.D.S data 2+	(11)	T.M.D.S clock shield
	(2)	T.M.D.S data 2 shield	(12)	T.M.D.S clock-
	(3)	T.M.D.S data 2-	(13)	CEC
	(4)	T.M.D.S data 1+	(14)	—
	(5)	T.M.D.S data 1 shield	(15)	SCL
	(6)	T.M.D.S data 1-	(16)	SDA
	(7)	T.M.D.S data 0+	(17)	DDC/CEC GND
	(8)	T.M.D.S data 0 shield	(18)	+5 V
	(9)	T.M.D.S data 0-	(19)	Hot plug detection
	(10)	T.M.D.S clock+		

Connecting example: AV equipment

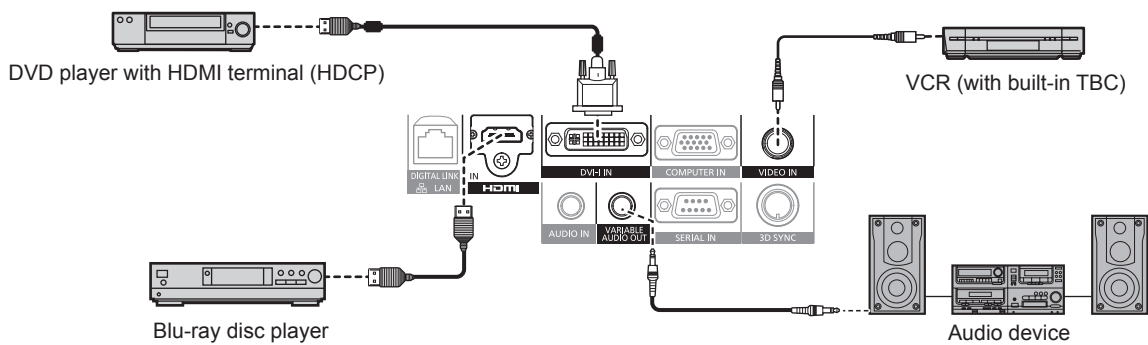

Attention

- Always use one of the following when connecting a VCR.
  - A VCR with built-in time base corrector (TBC)
  - A time base corrector (TBC) between the projector and the VCR
- If nonstandard burst signals are connected, the image may be distorted. In such case, connect the time base corrector (TBC) between the projector and the external devices.
- When inputting digital signals to the DVI-I terminal, use a commercially available cable with a ferrite core.

Note

- When a DVI digital signal is input, some external devices to be connected may require to switch the setting using the [DISPLAY OPTION] menu → [DVI-I IN] → [EDID].
- The <DVI-I IN> terminal can be connected to HDMI- or DVI-I-compliant devices. However, images may not appear or may not be displayed properly on some devices.
- For an HDMI cable, use an HDMI High Speed cable that conforms to HDMI standards. If a cable that does not conform to HDMI standards is used, images may be interrupted or may not be displayed.
- The <HDMI IN> terminal of the projector can be connected to an external device with a DVI terminal by using an HDMI/DVI conversion cable, but some devices may not project the image properly or function properly.
- The projector does not support VIERA Link (HDMI).
- If the [HDMI] and [DIGITAL LINK] settings in the [PROJECTOR SETUP] menu → [AUDIO SETTING] → [AUDIO IN SELECT] are incorrect, the projector may have malfunctions such as the absence of audio.

## Connecting example: Computers

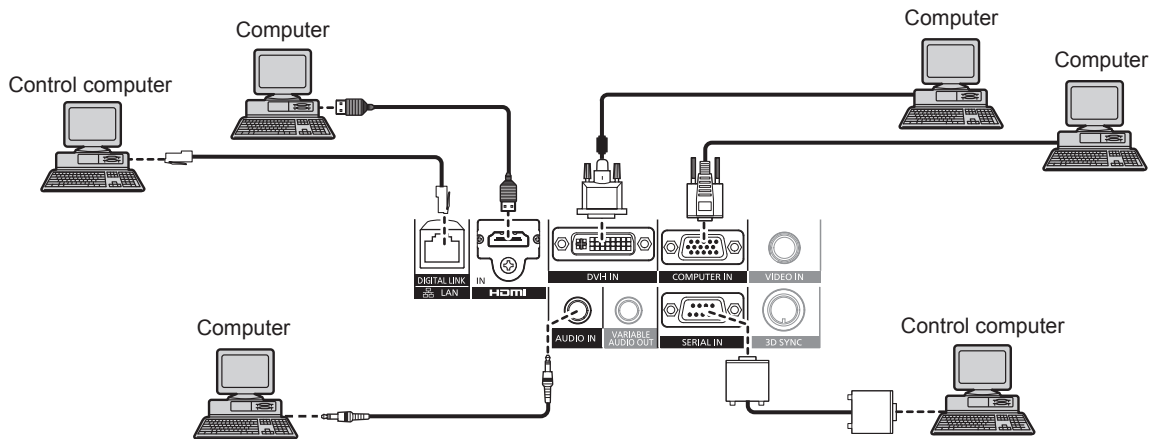

### Attention

- When connecting the projector to a computer or an external device, use the power cord supplied with each device and commercially available shielded cables.
- When inputting digital signals to the DVI-I terminal, use a commercially available cable with a ferrite core.

### Note

- When a DVI digital signal is input, some external devices to be connected may require to switch the setting using the [DISPLAY OPTION] menu → [DVI-I IN] → [EDID].
- For an HDMI cable, use an HDMI High Speed cable that conforms to HDMI standards. If a cable that does not conform to HDMI standards is used, images may be interrupted or may not be displayed.
- The <HDMI IN> terminal of the projector can be connected to an external device with an DVI terminal by using a HDMI/DVI conversion cable, but some devices may not project the image properly or function properly.
- The <DVI-I IN> terminal (for digital input) supports single link only.
- Refer to “List of compatible signals” (➔ page 130) for the types of video signals that can be used with the projector.
- If you operate the projector using the computer with the resume feature (last memory), you may have to reset the resume feature to operate the projector.
- If the [AUDIO IN SELECT] settings are incorrect, the projector may have malfunctions such as the absence of audio.

## Connecting example: Twisted-pair-cable transmitter

Twisted-pair-cable transmitters such as the optional digital interface box (Model No.: ET-YFB100G) use twisted-pair-cables to transmit input video, audio, Ethernet, and serial signals, and the projector can input those digital signals to the <DIGITAL LINK/LAN> terminal.

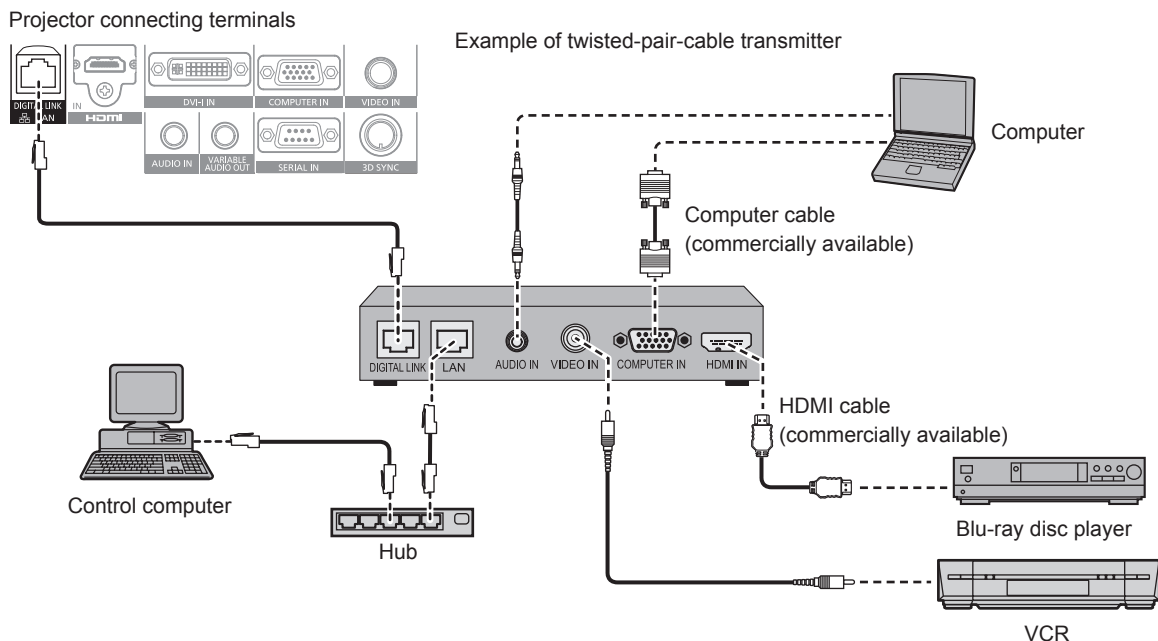

**Attention**

- Always use one of the following when connecting a VCR.
  - A VCR with built-in time base corrector (TBC)
  - A time base corrector (TBC) between the projector and the VCR
- If nonstandard burst signals are connected, the image may be distorted. In such case, connect the time base corrector (TBC) between the projector and the external devices.
- Use a commercial HDMI/DVI conversion cable with a ferrite core.
- Ask a qualified technician or your dealer to install the cable wiring for a twisted-pair-cable transmitter and the projector. Image and sound may be disrupted if cable transmission characteristics cannot be obtained due to inadequate installation.
- For the LAN cable between a twisted-pair-cable transmitter and the projector, use a cable that meets the following criteria:
  - Compatible with CAT5e or higher
  - Shielded type (including connectors)
  - Straight-through
  - Single wire
- When laying cables between a twisted-pair-cable transmitter and the projector, check that cable characteristics are compatible with CAT5e or higher using tools such as a cable tester or cable analyzer.  
When using a relay connector midway, include it in the measurement.
- Do not use a hub between a twisted-pair-cable transmitter and the projector.
- When connecting to the projector using a twisted-pair-cable transmitter (receiver) of other manufacturer, do not place another twisted-pair-cable transmitter (receiver) between the twisted-pair-cable transmitter of other manufacturer and the projector. This may cause sound and image to be disrupted.
- Do not pull cables forcefully. Also, do not bend or fold cables unnecessarily.
- To reduce the effects of noise as much as possible, stretch out the cables between the twisted-pair-cable transmitter and the projector without any loops.
- Lay the cables between a twisted-pair-cable transmitter and the projector away from other cables, particularly power cables.
- When installing multiple cables, run them side by side along the shortest distance possible without bundling them together.
- After laying the cables, confirm that the value of [SIGNAL QUALITY] in the [NETWORK] menu → [DIGITAL LINK STATUS] is displayed in green (indicates normal quality). (➔ page 99)

**Note**

- For an HDMI cable, use an HDMI High Speed cable that conforms to HDMI standards. If a cable that does not conform to HDMI standards is used, images may be interrupted or may not be displayed.
- The projector does not support VIERA Link (HDMI).
- The maximum transmission distance between the twisted-pair-cable transmitter and the projector is 100 m (328'1"). If this distance is exceeded, image and sound may be disrupted and may cause a malfunction in LAN communication. Please note that we do not support the use of the projector outside the maximum transmission distance.
- For twisted-pair-cable transmitter of other manufacturers of which the operation has been verified with the DIGITAL LINK compatible projector, refer to Panasonic website (<http://panasonic.net/avc/projector/>). Note that the verification for devices of other manufacturers has been made for the items set by Panasonic Corporation, and not all the operations have been verified. For operation or performance problems caused by the devices of other manufacturers, contact the respective manufacturers.

**Connecting example: IR transmitter**

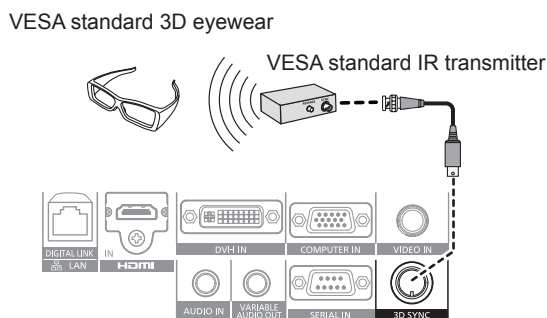

**Note**

- When viewing 3D images using VESA standard 3D eyewear, connect the commercially available VESA standard IR transmitter and set the [3D SETTINGS] menu → [3D MODE] to [3D SYNC] or [DLP Link + 3D SYNC].
- When using 3D eyewear that supports DLP Link, an IR transmitter is not required.  
When using 3D eyewear that supports DLP Link, set the [3D SETTINGS] menu → [3D MODE] to [DLP Link] or [DLP Link + 3D SYNC].



# Chapter 3 Basic Operations

---

This chapter describes basic operations to start with.

# Switching on/off the projector

## Connecting the power cord

Make sure that the supplied power cord is securely fixed to the projector body to prevent it from being removed easily.

Confirm that the <MAIN POWER> switch is on the <OFF> side before connecting the power cord.

For details of power cord handling, refer to "Read this first!" (➔ page 2).

## Attaching the power cord

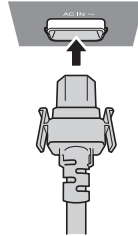

- 1) Check the shapes of the <AC IN> terminal on the side of the projector body and the power cord connector and insert the plug completely in the correct direction (until you hear the hooks click in place).

## Removing the power cord

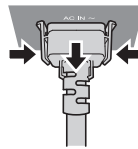

- 1) Confirm that the <MAIN POWER> switch on the side of the projector body is on the <OFF> side, and remove the power plug from the outlet.
- 2) Remove the power cord connector from the <AC IN> terminal of the projector body while pressing the side tabs.

## Power indicator

Displays the status of the power. Check the <ON (G)/STANDBY (R)> status of the power indicator before operating the projector.

When the light source indicator <LIGHT> and the temperature indicator <TEMP> are on or flashing, a problem may have occurred inside the projector. Check the status of the indicator before turning on the projector, and take appropriate steps. (➔ page 119)

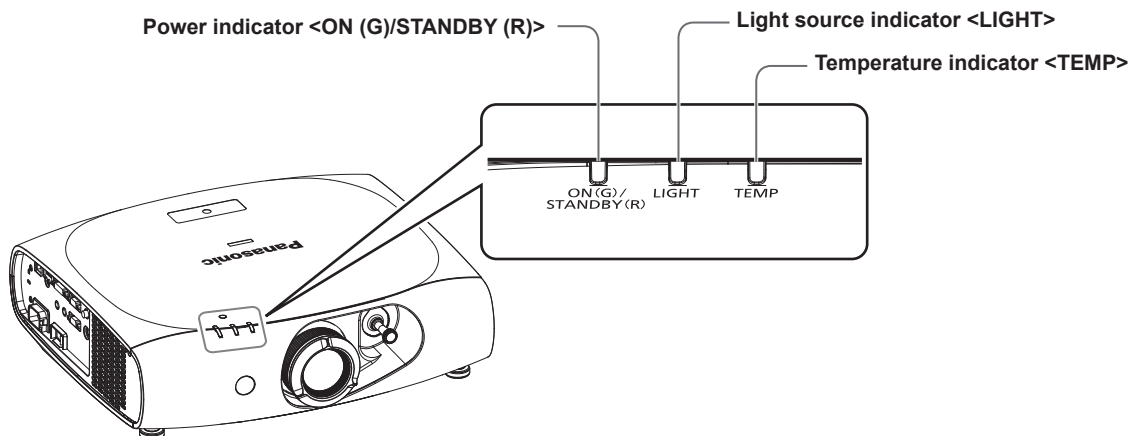

Indicator status		Projector status
Off		The main power is switched off.
Red	Flashing	The power is switched off (in standby mode). [STANDBY MODE] is set to [NORMAL]. Projection will start when the power <⏻/ > button is pressed. <ul style="list-style-type: none"> <li>The projector may not operate when the temperature indicator &lt;TEMP&gt; is flashing.</li> </ul>
	Lit	The power is switched off (in standby mode). [STANDBY MODE] is set to [ECO]. Projection will start when the power <⏻/ > button is pressed. <ul style="list-style-type: none"> <li>The projector may not operate when the temperature indicator &lt;TEMP&gt; is flashing.</li> </ul>
Green	Lit	Projecting.

### Note

- The projector consumes power even in standby mode (the power indicator <ON (G)/STANDBY (R)> lights/flashes in red). Refer to “Power consumption” (➔ page 133) for the power consumption.
- The power indicator <ON (G)/STANDBY (R)> flashes in green if a remote control signal is received.
- The power indicator <ON (G)/STANDBY (R)> flashes in green slowly when the projector is in AV mute mode.

### Switching on the projector

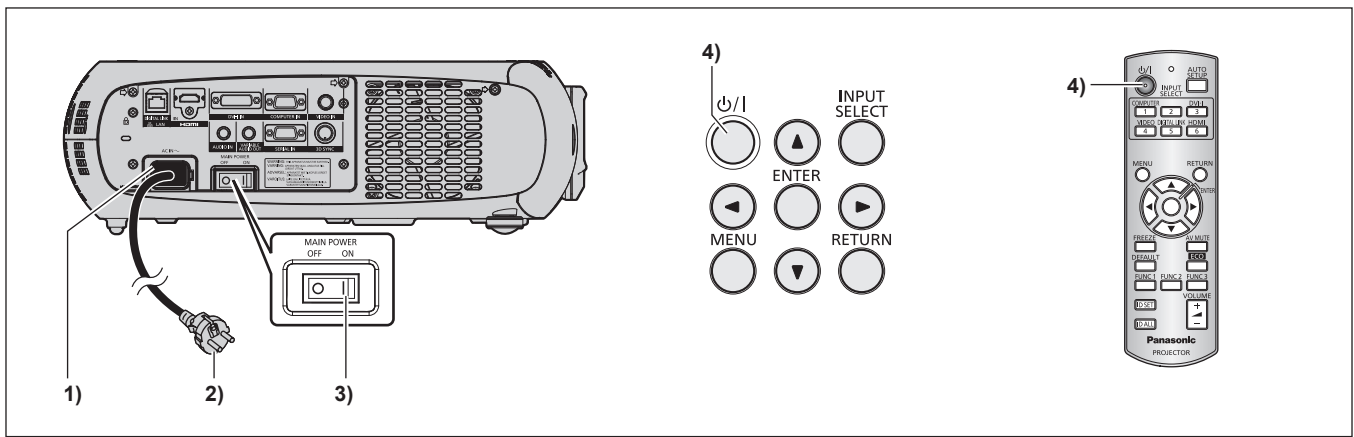

- 1) Connect the power cord to the projector body.**
- 2) Connect the power plug to an outlet.**
  - (AC 100 V - 240 V 50 Hz/60 Hz)
- 3) Press the <ON> side of the <MAIN POWER> switch to turn on the power.**
  - The power indicator <ON (G)/STANDBY (R)> lights/flashes in red, and the projector enters the standby mode.
- 4) Press the power <⏻/|> button.**
  - The power indicator <ON (G)/STANDBY (R)> lights in green and the image is soon projected on the screen.

### Note

- If the projector is switched on at around 0 °C (32 °F), a warm-up period of approximately five minutes may be necessary until an image is displayed. The temperature indicator <TEMP> lights during the warm-up period. When the warm-up is completed, the temperature indicator <TEMP> turns off and the projection starts. Refer to “When an indicator lights up” (➔ page 119) for the indicator status.
- If the operating environment temperature is low and warm-up takes more than five minutes, the projector will judge that a problem has occurred and the power will automatically be set to standby mode. If this happens, increase the operating environment temperature to 0 °C (32 °F) or higher, turn off the main power, and then turn on the power again.
- If the [PROJECTOR SETUP] menu → [ECO MANAGEMENT] → [STANDBY MODE] is set to [ECO], it may take more time before the projector starts projecting after the power is turned on compared with when [NORMAL] is set.
- When the power is turned on or an input signal is switched, you may hear a high-frequency driving sound. This is not a malfunction.
- If the [PROJECTOR SETUP] menu → [INITIAL STARTUP] is set to [LAST MEMORY] and the power is turned off by pressing the <OFF> side of the <MAIN POWER> switch or by using the breaker directly while projecting during the last time of use, the power indicator <ON (G)/STANDBY (R)> lights in green and projection starts after a while when the power is turned on by pressing the <ON> side of the <MAIN POWER> switch with the power plug connected to the outlet, or with the breaker turned on.

## Making adjustments and selections

It is recommended that images are projected continuously for at least 30 minutes before the focus is adjusted.

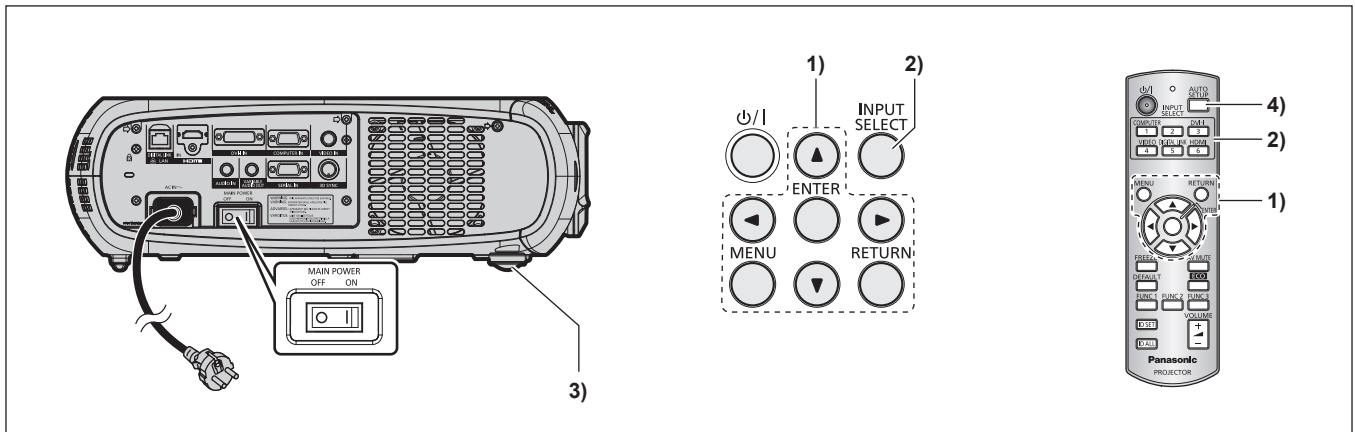

### 1) Set the initial settings. (➔ page 20)

- The initial setting screen is displayed when the projector is switched on for the first time after purchase as well as when [ALL USER DATA] in the [PROJECTOR SETUP] menu → [INITIALIZE] is executed.

### 2) Press the input selection (<COMPUTER>, <DVI-I>, <VIDEO>, <DIGITAL LINK>, <HDMI>) buttons to select the input signal.

### 3) Adjust the front, back and sideways tilt of the projector with the adjustable feet. (➔ page 28)

### 4) If the input signal is an RGB signal, press the <AUTO SETUP> button.

## Switching off the projector

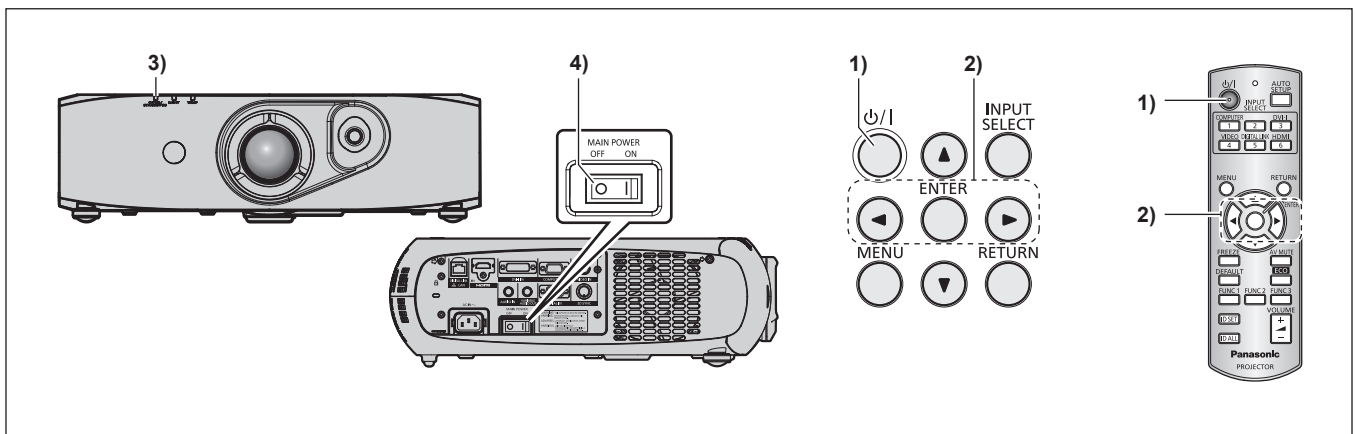

### 1) Press the power <⏻/> button.

- The [POWER OFF(STANDBY)] confirmation screen is displayed.

### 2) Press ◀▶ to select [OK], and press the <ENTER> button. (Or press the power <⏻/> button again.)

- Projection of the image stops.

### 3) Wait for a few seconds until the power indicator <ON (G)/STANDBY (R)> of the projector body lights/ flashes in red.

### 4) Press the <OFF> side of the <MAIN POWER> switch to turn off the power.

#### Note

- Even when the power <⏻/> button is pressed and the power is switched off, the projector consumes power if the main power of the projector is on. When the [PROJECTOR SETUP] menu → [STANDBY MODE] is set to [ECO], the power consumption during standby can be conserved.
- The power can be turned off by pressing the <OFF> side of the <MAIN POWER> switch while projecting or by directly using the breaker under conditions where the <MAIN POWER> switch of the projector cannot be switched off/on easily such as while mounting on the ceiling. However, the settings or adjustments performed right before the power is turned off may not be reflected.

# Projecting

Check the external device connections (➔ page 29) and the power cord connection (➔ page 34), and turn on the projector (➔ page 35) to start projecting. Select the video for projection, and adjust appearance of the projected image.

## Selecting the input signal

Select an input signal.

- 1) **Press the input selection (<COMPUTER>, <DVI-I>, <VIDEO>, <DIGITAL LINK>, <HDMI>) buttons on the remote control or the <INPUT SELECT> button on the control panel.**

- The image of the signal being input in the selected terminal is projected.

### Attention

- Images may not be projected properly depending on the external device, or the blu-ray disc or DVD disc, to be played back. Set the [PICTURE] menu → [SYSTEM SELECTOR].
- Confirm the aspect ratio of the projection screen and the image, and switch to an optimum aspect ratio from the [POSITION] menu → [ASPECT].

## Adjusting the image

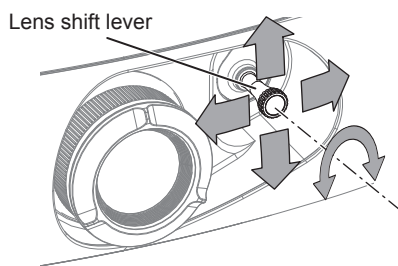

Fig. 1

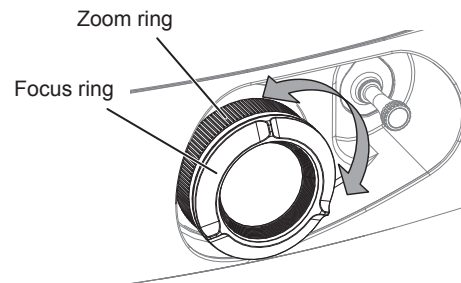

Fig. 2

- 1) **Adjust the projection angle.**
  - Install the projector on a flat surface and parallel to the screen so that the projected screen is rectangular.
  - If the screen is tilted downward, extend the adjustable feet and adjust the projection screen so that the projected screen is rectangular.
  - Refer to “Adjusting adjustable feet” (➔ page 28) for details.
- 2) **Release the lens shift lever lock by turning it counter-clockwise.**
- 3) **Adjust the lens shift. (Fig. 1)**
  - Adjust the projection position using the lens shift lever.
  - Refer to “Adjustment range by the lens position shift (optical shift)” (➔ page 39) for details.
- 4) **Lock the lens shift lever by turning it clockwise.**
- 5) **Adjust the zoom and focus. (Fig. 2)**
  - Adjust by turning the zoom ring and focus ring.

### Attention

- Note that your fingers may get caught between the lens and surrounding area when adjusting the zoom, depending on the position of the hand holding the zoom ring.

### Note

- It is recommended that images are projected continuously for at least 30 minutes before the focus is adjusted.
- Turning the focus ring changes the projection screen size. Make fine adjustments again to the projection screen size by turning the zoom ring.
- When there is trapezoidal distortion, execute the [POSITION] menu → [KEYSTONE].

## Viewing 3D images

To project/view 3D images, you need active shutter system 3D eyewear, 3D content, and devices that can play 3D content.

The projector only supports frame packing system, side by side system, top and bottom system, and frame sequential system as 3D video signal input. Other systems are not supported.

The active shutter system 3D eyewear supports DLP Link system and VESA standard IR (Infrared) system. However, not all the 3D eyewear operations have been verified.

### Attention

- Be sure to read “VIEWING 3D VIDEO” in “Read this first!” (➔ page 8) before projecting/viewing 3D images.
- Also read the operating instructions of 3D eyewear when using 3D eyewear.
- If you use 3D eyewear in a room with the fluorescent light turned on, light may flicker or 3D images may not be viewed properly. In such a case, turn off the fluorescent light.
- Take off 3D eyewear before viewing displays other than 3D images (such as computer screen, digital clock, calculator).

### 3D eyewear with DLP Link system support

You can project/view 3D images using 3D eyewear that supports DLP Link through the following procedure.

Turn on the projector.

- 1) **Turn on the 3D eyewear.**
- 2) **Change projector settings to use the 3D eyewear.**
  - To set, select [DLP Link] or [DLP Link + 3D SYNC] in the [3D SETTINGS] menu → [3D MODE].

### Note

- Change the setting in the [3D SETTINGS] menu → [LEFT/RIGHT SWAP] → [DLP Link], if there is something wrong with 3D images.
- The 3D eyewear that supports DLP Link operates by receiving synchronized signals of 3D images which are included in projection light reflected on the screen, and images can be viewed in three dimensions.  
Depending on the conditions such as projection screen size, brightness of installation location, viewing distance, and brightness of the light source, synchronized signals may not be received properly and you may not view 3D images correctly.
- To view 3D images using the 3D eyewear that supports DLP Link system, the 3D eyewear is required to be synchronized to the following frequency according to the vertical scanning frequency of 3D video signals. For 3D eyewear specifications, contact the companies of 3D eyewear.

Vertical scanning frequency	3D eyewear supporting frequency
60 Hz/120 Hz	120 Hz
50 Hz/100 Hz	100 Hz
24 Hz	96 Hz

### 3D eyewear with VESA standard IR (Infrared) system support

You can project/view 3D images using 3D eyewear that supports VESA standard IR (Infrared) system through the following procedure.

Turn off the projector.

- 1) **Connect the IR transmitter cable to the <3D SYNC> terminal on the projector.**
- 2) **Turn on the projector, 3D eyewear, and IR transmitter.**
- 3) **Change projector settings to use the 3D eyewear.**
  - To set, select [3D SYNC] or [DLP Link + 3D SYNC] in the [3D SETTINGS] menu → [3D MODE].

### Note

- Change the setting in the [3D SETTINGS] menu → [LEFT/RIGHT SWAP] → [3D SYNC], if there is something wrong with 3D images.

## Adjustment range by the lens position shift (optical shift)

Perform the lens position shift within the adjustment range.

The focus may change when the lens position is shifted out of the adjustment range. This is because the movement of the lens is restricted to protect the optical parts. Projection position can be adjusted with the optical axis shift based on the standard projection position in the range shown in the following figures.

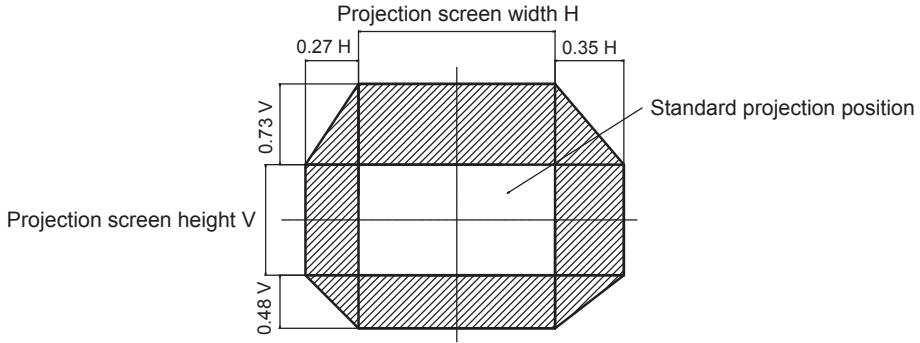
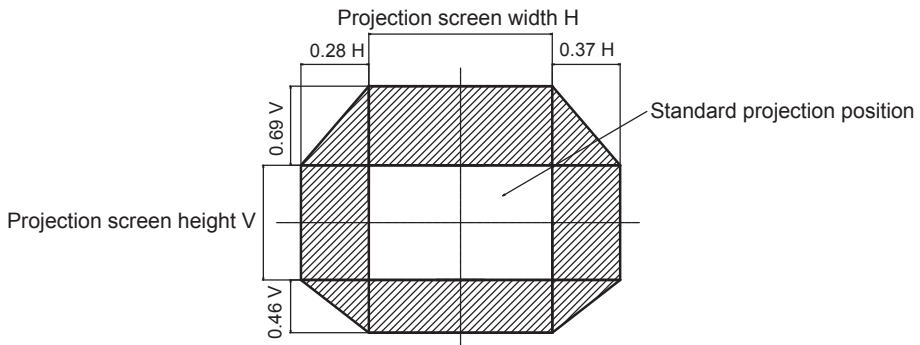
<p>PT-RZ470E series</p>	 <p>The diagram shows a projection screen with width <math>H</math> and height <math>V</math>. The standard projection position is indicated by a central rectangle. The adjustment range is defined by a larger rectangle with a top width of <math>0.27H</math> and <math>0.35H</math>, and a bottom height of <math>0.73V</math> and <math>0.48V</math>.</p>
<p>PT-RW430E series</p>	 <p>The diagram shows a projection screen with width <math>H</math> and height <math>V</math>. The standard projection position is indicated by a central rectangle. The adjustment range is defined by a larger rectangle with a top width of <math>0.28H</math> and <math>0.37H</math>, and a bottom height of <math>0.69V</math> and <math>0.46V</math>.</p>

\* The numerical values in the preceding diagrams represent a case in which the projector is set on a desk/floor.

### Note

- The best screen can be achieved by installing the projector in front of the screen and adjusting the lens shift lever towards the center.

# Operating with the remote control

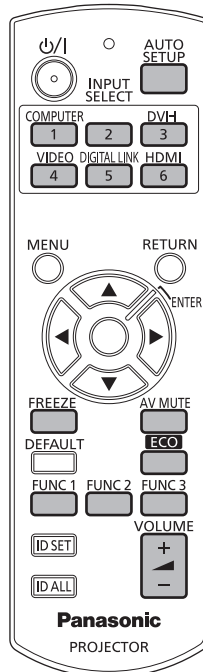

## Using the AV mute function

If the projector is not used for a certain period of time during the meeting intermission, for example, it is possible to turn off the audio and video temporarily.

### AV MUTE



button

- 1) **Press the <AV MUTE> button.**
  - The audio and video turn off.
- 2) **Press the <AV MUTE> button again.**
  - The audio and video turn on.

### Note

- The power indicator <ON (G)/STANDBY (R)> flashes slowly when the projector is in AV mute mode.
- The projector has no built-in speakers. Audio is output from the external sound system connected to the <VARIABLE AUDIO OUT> terminal.

## Using the Freeze function

The projected image can be paused temporarily and the audio muted, regardless of the playback of the external equipment.

### FREEZE



button

- 1) **Press the <FREEZE> button.**
  - The video is paused and the audio is muted.
- 2) **Press the <FREEZE> button again.**
  - The video playback resumes and the audio is unmuted.

### Note

- [FREEZE] is displayed on the screen when the video is paused.



## Switching the input

The input for projection can be switched.

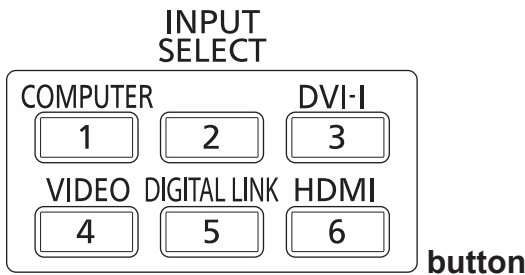

### 1) Press the input selection (<COMPUTER>, <DVI-I>, <VIDEO>, <DIGITAL LINK>, <HDMI>) buttons.

- This operation can be also performed using the <INPUT SELECT> button on the control panel.

<COMPUTER>	Switch the input to COMPUTER.
<DVI-I>	Switch the input to DVI-I.
<VIDEO>	Switch the input to VIDEO.
<DIGITAL LINK>	Switch the input to DIGITAL LINK.
<HDMI>	Switch the input to HDMI.

### Note

- When the optional digital interface box (Model No.: ET-YFB100G) is connected to the <DIGITAL LINK/LAN> terminal, the ET-YFB100G input changes with each press of the <DIGITAL LINK> button.  
For twisted-pair-cable transmitters of other manufacturers, switch the input on the projector to DIGITAL LINK, and then switch the input on the twisted-pair-cable transmitter.

## Using the Automatic setup function

The automatic setup function can be used to automatically adjust the resolution, clock phase, and image position when analog RGB signals consisting of bitmap images such as computer signals are being input, or to automatically adjust the image position when DVI-D/HDMI signals are input. Supplying images with bright white borders at the edges and high-contrast black and white characters is recommended when the system is in automatic adjustment mode.

Avoid supplying images that include halftones or gradation, such as photographs and computer graphics.



### 1) Press the <AUTO SETUP> button.

- [COMPLETE] is displayed when it has completed without any problem.

### Note

- The clock phase may shift even if it has completed without any incident. In such cases, adjust the [POSITION] menu → [CLOCK PHASE] (➔ page 56).
- If an image with blurred edges or a dark image is input, [INCOMPLETE] may appear or adjustment may not be performed properly even when [COMPLETE] appears. In this case, adjust the settings in the [ADVANCED MENU] menu → [INPUT RESOLUTION] (➔ page 59), [POSITION] → [CLOCK PHASE] (➔ page 56), and [SHIFT] (➔ page 54).
- Adjust special signals according to the [DISPLAY OPTION] menu → [AUTO SETUP] (➔ page 69).
- Automatic adjustment may not work depending on the model of the computer.
- Automatic adjustment may not work for a synchronization signal of C-SY or SYNC ON GREEN.
- Images may be disrupted for a few seconds during automatic adjustment, but it is not a malfunction.
- Adjustment is required for each input signal.
- Automatic adjustment can be canceled by pressing the <RETURN> or <MENU> button during the automatic adjustment operation.
- If the automatic setup function is used while moving images are being input, the adjustment may not be performed properly even for an RGB signal that can use automatic setup. [INCOMPLETE] may appear, or adjustment may not be finished properly even if [COMPLETE] appears.

## Using the Function button

Frequently used operations can be assigned to the buttons from <FUNC1> to <FUNC3> on the remote control to be used as simple shortcut buttons.



- 1) Press the <FUNC1> to <FUNC3> buttons.

### When assigning operations to the buttons from <FUNC1> to <FUNC3>

- 1) Press the <MENU> on the control panel or the remote control to display the menu items (main menu, sub-menu, or details menu) you want to assign.
  - Refer to "Navigating through the menu" (➔ page 44) for the operation of the on-screen menu.
- 2) Press and hold any buttons from <FUNC1> to <FUNC3> for three seconds or more.

#### Note

- After settings have been completed, F1, F2, or F3 is displayed on the left of the assigned menu item (main menu, sub-menu, or details menu) when <FUNC1>, <FUNC2>, or <FUNC3> is set, respectively.
- Perform the [PROJECTOR SETUP] menu → [FUNCTION BUTTON] (➔ page 87) when deallocating functions.

## Using the ECO management function

The setting screen related to the ECO management can be displayed.



- 1) Press the <ECO> button on the remote control.

#### Note

- Refer to the [PROJECTOR SETUP] menu → [ECO MANAGEMENT] (➔ page 77) for details.

## Adjusting the volume

The audio output volume can be adjusted.

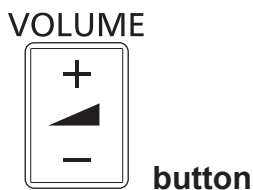

- 1) Press the <VOLUME+>/<VOLUME-> button on the remote control.

<VOLUME+>	Increases the volume.
<VOLUME->	Decreases the volume.

# Chapter 4 Settings

---

This chapter describes the settings and adjustments you can make using the on-screen menu.

# Menu navigation

The on-screen menu (Menu) is used to perform various settings and adjustments of the projector.

## Navigating through the menu

### Operating procedure

#### MENU



**1) Press the <MENU> button on the remote control or control panel.**

- The [MAIN MENU] screen is displayed.

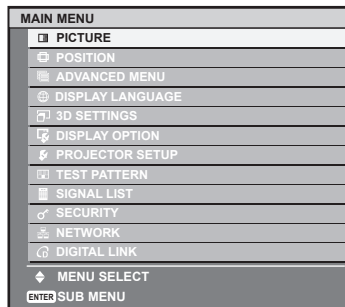

**2) Press ▲▼ to select an item from the main menu.**

- The selected item is highlighted in yellow.

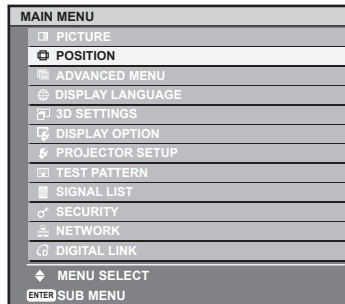

**3) Press the <ENTER> button.**

- The sub-menu items of the selected main menu are displayed.

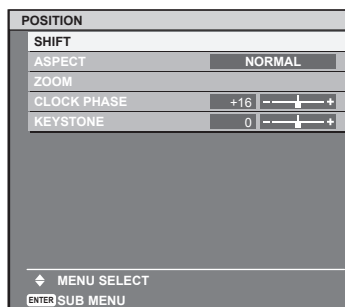

**4) Press ▲▼ to select a sub-menu, and press ◀▶ or the <ENTER> button to change or adjust settings.**

- Some items will switch in order as follows each time you press ◀▶.

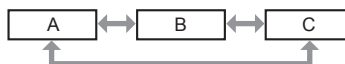

- For some items, press ◀▶ to display an individual adjustment screen with a bar scale as shown below.



**Note**

- Pressing the <RETURN> button or the <MENU> button while the menu screen is displayed returns to the upper hierarchical menu screen.
- Some items may not be adjusted or used for certain signal formats to be input to the projector. The menu items that cannot be adjusted or used are shown in gray characters, and they cannot be selected.
- Some items can be adjusted even if signals are not input.
- Individual adjustment screen is cleared automatically if no operation is performed for approximately five seconds.
- For menu items, refer to “Main menu” (➔ page 45) and “Sub-menu” (➔ page 46).
- The cursor color depends on the settings of the [OSD DESIGN] menu (➔ page 72). The selected item is displayed with the yellow cursor by default.
- In a portrait setting, the menu is displayed sideways.

**Resetting adjustment values to the factory default**

If the <DEFAULT> button on the remote control is pressed, the values adjusted in the menu items are restored to the factory default settings.

**DEFAULT**



**button**

1) Press the <DEFAULT> button on the remote control.



**Note**

- You cannot reset all the settings to the factory default at a time.
- To reset all the settings adjusted in the sub-menu item to the factory default one at a time, execute [PROJECTOR SETUP] menu → [INITIALIZE] (➔ page 91).
- Some items cannot be reset by pressing the <DEFAULT> button. Adjust each item manually.
- The square mark under the bar scale in the individual adjustment screen indicates the factory default setting. The position of the square mark varies by the selected input signals.

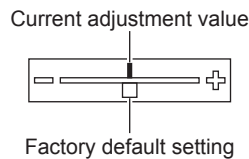

**Setting the on-screen display to show/hide**

If you press the <MENU> button on the control panel or the remote control for at least three seconds, the on-screen display setup screen is displayed and the on-screen display can be set to show/hide.

**Note**





- If the [SECURITY] menu → [TEXT DISPLAY] is [ON], the on-screen setting screen cannot be displayed.

**Main menu**

The main menu consists of the following 12 items.

When a main menu item is selected, the screen changes to a sub-menu selection screen.

Main menu item		Page
	[PICTURE]	49
	[POSITION]	54
	[ADVANCED MENU]	58
	[DISPLAY LANGUAGE]	63
	[3D SETTINGS]	64
	[DISPLAY OPTION]	67
	[PROJECTOR SETUP]	76

Main menu item		Page
	[TEST PATTERN]	92
	[SIGNAL LIST]	93
	[SECURITY]	95
	[NETWORK]	98
	[DIGITAL LINK]	117

## Sub-menu

The sub-menu of the selected main menu item is displayed, and you can set and adjust items in the sub-menu.

### [PICTURE]

Sub-menu item	Factory default	Page
[PICTURE MODE]	[GRAPHIC]*1	49
[CONTRAST]	[0]	49
[BRIGHTNESS]	[0]	50
[COLOR]	[0]	50
[TINT]	[0]	50
[COLOR TEMPERATURE]	[DEFAULT]	50
[DAYLIGHT VIEW]	[AUTO]	52
[SHARPNESS]	[6]*1	52
[NOISE REDUCTION]	[OFF]*1	52
[SYSTEM SELECTOR]	[Y <sub>B</sub> P <sub>R</sub> ]*1	53

\*1 Depends on the signal input.

### Note

- The factory default settings may vary depending on the picture mode.

### [POSITION]

Sub-menu item	Factory default	Page
[SHIFT]	—	54
[ASPECT]	[NORMAL]	55
[ZOOM]	—	55
[CLOCK PHASE]	[16]*1	56
[KEystone]	[0]	57

\*1 Depends on the signal input.

### [ADVANCED MENU]

Sub-menu item	Factory default	Page
[DIGITAL CINEMA REALITY]	[AUTO]*1	58
[BLANKING]	—	58
[INPUT RESOLUTION]	—	59
[CLAMP POSITION]	[24]*1	59
[EDGE BLENDING]	[OFF]	59
[FRAME RESPONSE]	[NORMAL]	61
[RASTER POSITION]	—	62

\*1 Depends on the signal input.

**Note**

- Sub-menu items and factory default settings differ depending on the input terminal that is selected.

**[DISPLAY LANGUAGE]** 

Details (➔ page 63)

**[3D SETTINGS]** 

Sub-menu item	Factory default	Page
[3D MODE]	[DLP Link]*1	64
[3D SYNC OUTPUT DELAY]	[0us]	64
[LEFT/RIGHT SWAP]	[NORMAL]	64
[3D INPUT FORMAT]	[AUTO]*1	65
[SAFETY PRECAUTIONS MESSAGE]	[ON]	65
[3D SAFETY PRECAUTIONS]	—	66

\*1 Depends on the signal input.

**[DISPLAY OPTION]** 

Sub-menu item	Factory default	Page
[COLOR MATCHING]	[OFF]	67
[SCREEN SETTING]*1	—	68
[AUTO SIGNAL]	[OFF]	69
[AUTO SETUP]	—	69
[COMPUTER IN]	—	69
[DVI-I IN]	—	70
[HDMI IN]	—	71
[DIGITAL LINK IN]	—	71
[ON-SCREEN DISPLAY]	—	71
[CLOSED CAPTION SETTING]	—	73
[BACK COLOR]	[BLUE]	74
[STARTUP LOGO]	[DEFAULT LOGO]	74
[SUB MEMORY LIST]	—	74
[FREEZE]	—	75
[AV MUTE]	—	75

\*1 Only for the PT-RW430E series.

**[PROJECTOR SETUP]** 

Sub-menu item	Factory default	Page
[PROJECTOR ID]	[ALL]	76
[PROJECTION METHOD]	[FRONT/FLOOR]	76
[COOLING CONDITION]	[FLOOR SETTING]	77
[HIGH ALTITUDE MODE]	[OFF]	77
[ECO MANAGEMENT]	—	77
[BRIGHTNESS CONTROL]	—	79
[SCHEDULE]	[OFF]	83
[INITIAL STARTUP]	[LAST MEMORY]	85
[STARTUP INPUT SELECT]	[LAST USED]	85
[DIGITAL LINK INPUT]	—	85
[RS-232C]	—	86
[FUNCTION BUTTON]	—	87
[AUDIO SETTING]	—	88
[STATUS]	—	89

Sub-menu item	Factory default	Page
[DATE AND TIME]	—	90
[SAVE ALL USER DATA]	—	90
[LOAD ALL USER DATA]	—	91
[INITIALIZE]	—	91
[SERVICE PASSWORD]	—	91

**[TEST PATTERN]** 

Details (➔ page 92)

**[SIGNAL LIST]** 

Details (➔ page 93)

**[SECURITY]** 

Sub-menu item	Factory default	Page
[SECURITY PASSWORD]	[OFF]	95
[SECURITY PASSWORD CHANGE]	—	95
[TEXT DISPLAY]	[OFF]	96
[TEXT CHANGE]	—	96
[MENU LOCK]	[OFF]	96
[MENU LOCK PASSWORD]	—	96
[CONTROL DEVICE SETUP]	—	97

**[NETWORK]** 

Sub-menu item	Factory default	Page
[DIGITAL LINK MODE]	[AUTO]	98
[DIGITAL LINK SETUP]	—	98
[DIGITAL LINK STATUS]	—	99
[NETWORK SETUP]	—	99
[NETWORK CONTROL]	—	100
[NETWORK STATUS]	—	100

**[DIGITAL LINK]** 

Details (➔ page 117)

**Note**

- Some items may not be adjusted or used for certain signal formats to be input to the projector.
- The menu items that cannot be adjusted or used are shown in gray characters, and they cannot be selected.
- Sub-menu items and factory default settings differ depending on the selected input terminal.



## [PICTURE] menu

On the menu screen, select [PICTURE] from the main menu, and select the item from the sub-menu.

Refer to “Navigating through the menu” (→ page 44) for the operation of the menu screen.

- After selecting the item, press ▲▼◀▶ to set.

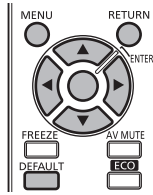

### [PICTURE MODE]

You can switch to the desired picture mode suitable for the image source and the environment in which the projector is used.

- 1) Press ▲▼ to select [PICTURE MODE].
- 2) Press ◀▶ to switch [PICTURE MODE].
  - The items will switch each time you press the button.

[GRAPHIC]	The image becomes suitable for input from the personal computer.
[STANDARD]	The image becomes suitable for moving images in general.
[CINEMA]	The image becomes suitable for movie sources.
[NATURAL]	The image is sRGB compliant.
[REC709]*1	The image is Rec.709 compliant.
[DICOM SIM.]*1	The image becomes similar to that of DICOM Part 14 Grayscale Standard.
[DYNAMIC]	Color and brightness are optimized and image becomes suitable for video content.

\*1 Use the factory default for the settings under the [PICTURE] menu other than [PICTURE MODE].

#### Note

- The factory default picture mode is [GRAPHIC] for still image input signals and [STANDARD] for movie-based input signals.
- [DYNAMIC] cannot be selected when viewing 3D images. Even when [DYNAMIC] is selected while viewing 2D images, the setting is switched to [GRAPHIC] automatically once viewing 3D images.
- Rec.709 is an abbreviation of “ITU-R Recommendation BT.709” and is color standard of high-definition television.
- DICOM is an abbreviation of “Digital Imaging and COmmunication in Medicine” and is a standard for medical imaging devices. Although the DICOM name is used, the projector is not a medical device, and should not be used for purposes such as diagnosis of display images.

### [CONTRAST]

You can adjust the contrast of the colors.

- 1) Press ▲▼ to select [CONTRAST].
- 2) Press ◀▶ or the <ENTER> button.
  - The [CONTRAST] individual adjustment screen is displayed.
- 3) Press ◀▶ to adjust the level.

Operation	Adjustment	Range of adjustment
Press the ▶ button.	Brightens the screen and makes the color deeper.	-31 - 31
Press the ◀ button.	Darkens the screen and makes the color lighter.	

#### Attention

- Adjust [BRIGHTNESS] first when you need to adjust the black level.

**[BRIGHTNESS]**

You can adjust the dark (black) part of the projected image.

- 1) Press ▲▼ to select [BRIGHTNESS].
- 2) Press ◀▶ or the <ENTER> button.
  - The [BRIGHTNESS] individual adjustment screen is displayed.
- 3) Press ◀▶ to adjust the level.

Operation	Adjustment	Range of adjustment
Press the ▶ button.	Increases the brightness of the dark (black) parts of the screen.	-31 - 31
Press the ◀ button.	Reduces the brightness of the dark (black) parts of the screen.	

**[COLOR]**

You can adjust the color saturation of the projected image.

- 1) Press ▲▼ to select [COLOR].
- 2) Press ◀▶ or the <ENTER> button.
  - The [COLOR] individual adjustment screen is displayed.
- 3) Press ◀▶ to adjust the level.

Operation	Adjustment	Range of adjustment
Press the ▶ button.	Deepens colors.	-31 - 31
Press the ◀ button.	Weakens colors.	

**[TINT]**

You can adjust the skin tone in the projected image.

- 1) Press ▲▼ to select [TINT].
- 2) Press ◀▶ or the <ENTER> button.
  - The [TINT] individual adjustment screen is displayed.
- 3) Press ◀▶ to adjust the level.

Operation	Adjustment	Range of adjustment
Press the ▶ button.	Adjusts skin tone toward greenish color.	-31 - 31
Press the ◀ button.	Adjusts skin tone toward reddish purple.	

**[COLOR TEMPERATURE]**

You can switch the color temperature if the white areas of the projected image are bluish or reddish.

**Adjusting with color temperature**

- 1) Press ▲▼ to select [COLOR TEMPERATURE].
- 2) Press ◀▶ or the <ENTER> button.
  - The [COLOR TEMPERATURE] individual adjustment screen is displayed.
- 3) Press ◀▶ to switch [COLOR TEMPERATURE].
  - The items will switch each time you press the button.

[DEFAULT]	Factory default setting.
[USER]	Adjusts white balance as desired. Refer to "Adjusting desired white balance" to be described later for details.
[MIDDLE]	Select so that images become natural.
[HIGH]	

**Note**

- When “[PICTURE MODE]” (➔ page 49) is set to [DYNAMIC], [COLOR TEMPERATURE] is fixed to [USER]. (However, [WHITE BALANCE HIGH] cannot be adjusted.)
- When [COLOR MATCHING] (➔ page 67) adjustment is set to other than [OFF], [COLOR TEMPERATURE] is fixed to [USER].

**Adjusting desired white balance**

- 1) Press ▲▼ to select [COLOR TEMPERATURE].
- 2) Press ◀▶ or the <ENTER> button.
  - The [COLOR TEMPERATURE] individual adjustment screen is displayed.
- 3) Press ◀▶ to select [USER].
- 4) Press the <ENTER> button.
  - The [COLOR TEMPERATURE] screen is displayed.
- 5) Press ▲▼ to select [WHITE BALANCE].
- 6) Press the <ENTER> button.
  - The [WHITE BALANCE] screen is displayed.
- 7) Press ▲▼ to select [WHITE BALANCE HIGH] or [WHITE BALANCE LOW].
- 8) Press the <ENTER> button.
  - The [WHITE BALANCE HIGH] screen or the [WHITE BALANCE LOW] screen is displayed.
- 9) Press ▲▼ to select [RED], [GREEN], or [BLUE].
- 10) Press ◀▶ to adjust the level.

Item	Operation	Adjustment	Range of adjustment
[RED]	Press the ▶ button.	Deepens red.	[WHITE BALANCE HIGH]: 0 - 255 (factory default is 255) [WHITE BALANCE LOW]: -127 - 127 (factory default is 0)
	Press the ◀ button.	Weakens red.	
[GREEN]	Press the ▶ button.	Deepens green.	
	Press the ◀ button.	Weakens green.	
[BLUE]	Press the ▶ button.	Deepens blue.	
	Press the ◀ button.	Weakens blue.	

**Note**

- Adjust [COLOR TEMPERATURE] correctly. All colors will not be displayed properly unless adequate adjustment is made. If the adjustment does not look suitable, you can press the <DEFAULT> button on the remote control to return the setting for the selected item only to the factory default setting.
- The setting of [COLOR TEMPERATURE] is not reflected in internal test patterns (➔ page 92). Make sure to set [COLOR TEMPERATURE] while projecting input signal.

**Changing the [USER] name**

- 1) Press ▲▼ to select [COLOR TEMPERATURE].
- 2) Press ◀▶ or the <ENTER> button.
  - The [COLOR TEMPERATURE] individual adjustment screen is displayed.
- 3) Press ◀▶ to select [USER].
- 4) Press the <ENTER> button.
  - The [COLOR TEMPERATURE] screen is displayed.
- 5) Press ▲▼ to select [COLOR TEMPERATURE NAME CHANGE].
- 6) Press the <ENTER> button.
  - The [COLOR TEMPERATURE NAME CHANGE] screen is displayed.
- 7) Press ▲▼◀▶ to select the text, and press the <ENTER> button to enter the text.
- 8) Press ▲▼◀▶ to select [OK], and press the <ENTER> button.
  - The name set to color temperature is changed.

**Note**

- When a name is changed, display of the [USER] menu is also changed.

**[DAYLIGHT VIEW]**

You can correct the image to the optimal vividness even if it is projected under a bright light.

- 1) Press ▲▼ to select [DAYLIGHT VIEW].
- 2) Press ◀▶ or the <ENTER> button.
  - The [DAYLIGHT VIEW] individual adjustment screen is displayed.
- 3) Press ◀▶ to switch [DAYLIGHT VIEW].
  - The items will switch each time you press the button.

[AUTO]	Corrects the image vividness automatically.
[OFF]	No correction.
[1]	Corrects the image to weaken vividness.
[2]	Corrects the image to medium vividness.
[3]	Corrects the image to high vividness.

**Note**

- If [ON] is selected from the [ADVANCED MENU] menu → [EDGE BLENDING], [AUTO] cannot be set.
- If [REAR/FLOOR] or [REAR/CEILING] is selected from the [PROJECTOR SETUP] menu → [PROJECTION METHOD], [AUTO] cannot be set.
- [AUTO] mode may not operate properly if objects are placed on top of the projector.
- If [PICTURE MODE] is [NATURAL], [REC709], or [DICOM SIM.], the factory default setting is [OFF].

**[SHARPNESS]**

You can adjust the sharpness of the projected image.

- 1) Press ▲▼ to select [SHARPNESS].
- 2) Press ◀▶ or the <ENTER> button.
  - The [SHARPNESS] individual adjustment screen is displayed.
- 3) Press ◀▶ to adjust the level.

Operation	Adjustment	Range of adjustment
Press the ▶ button.	Contours become sharper.	0 - 15
Press the ◀ button.	Contours become softer.	

**Note**

- If you press ▶ while the adjustment value is [15], the value will become [0]. If you press ◀ while the adjustment value is [0], the value will become [15].
- [SHARPNESS] cannot be set while displaying 3D images.

**[NOISE REDUCTION]**

You can reduce noises when the input image is degraded and noise is occurring in the image signal.

- 1) Press ▲▼ to select [NOISE REDUCTION].
- 2) Press ◀▶ or the <ENTER> button.
  - The [NOISE REDUCTION] individual adjustment screen is displayed.
- 3) Press ◀▶ to switch [NOISE REDUCTION].
  - The items will switch each time you press the button.

[OFF]	No correction.
[ON]	Corrects the noise.

**Attention**

- Setting the projector may result in an image that appears different from the actual image. In such a case, set it to [OFF].
- [NOISE REDUCTION] cannot be set when viewing 3D videos.

## [SYSTEM SELECTOR]

The projector will automatically detect the input signal, but you can set the system method manually when an unstable signal is input. Set the system method matching the input signal.

1) Press **▲▼** to select **[SYSTEM SELECTOR]**.

2) Press the **<ENTER>** button.

3) Press **▲▼** to select a system format.

- Available system formats vary depending on the input signal.

Terminal	System format	
<VIDEO IN> terminal	Select [AUTO], [NTSC], [NTSC4.43], [PAL], [PAL-M], [PAL-N], [SECAM], or [PAL60]. Set it to [AUTO] normally. (Setting [AUTO] will automatically select [NTSC], [NTSC4.43], [PAL], [PAL-M], [PAL-N], [SECAM], or [PAL60].) Switch the setting to the signal method for the TV used.	
<COMPUTER IN> terminal, <DVI-I IN> terminal*1	<b>480i, 576i, or 576p signal</b>	Select [RGB] or [YCbCr].
	<b>VGA60 or 480p signal</b>	Select [VGA60], [480p], or [480pRGB].
	<b>Other movie-based signals</b>	Select [RGB] or [YPbPr].
<DVI-I IN> terminal*2	<b>480p or 576p signal</b>	Select [RGB], [YCbCr444], or [YCbCr422].
	<b>Other movie-based signals</b>	Select [RGB], [YPbPr444], or [YPbPr422].
<HDMI IN> terminal	<b>480p or 576p signal</b>	Select [AUTO], [RGB], [YCbCr444], or [YCbCr422].
	<b>Other movie-based signals</b>	Select [AUTO], [RGB], [YPbPr444], or [YPbPr422].

\*1 When [DVI-I IN] is set to [ANALOG].

\*2 When [DVI-I IN] is set to [DIGITAL].

4) Press the **<ENTER>** button.

### Note

- Refer to “List of compatible signals” (➔ page 130) for the types of video signals that can be used with the projector.
- This may not function properly for some connected external devices.

## sRGB-compliant video

sRGB is an international standard (IEC61966-2-1) for color reproduction defined by IEC (International Electrotechnical Commission). Set the projector using the following procedures for more accurate color reproduction that complies with sRGB.

1) Set **[COLOR MATCHING]** adjustments to **[OFF]**.

- Refer to [COLOR MATCHING] (➔ page 67).

2) Display the **[PICTURE]** menu.

- Refer to “[PICTURE] menu” (➔ page 49).

3) Press **▲▼** to select **[PICTURE MODE]**.

4) Press **◀▶** to set **[NATURAL]**.

5) Press **▲▼** to select **[COLOR]**.

6) Press the **<DEFAULT>** button on the remote control to set factory default settings.

7) Follow Steps 5) to 6) to set factory default settings for **[TINT]** and **[COLOR TEMPERATURE]**.

### Note

- sRGB is available for RGB signal input only.

## [POSITION] menu

On the menu screen, select [POSITION] from the main menu, and select the item from the sub-menu.

Refer to “Navigating through the menu” (➔ page 44) for the operation of the menu screen.

- After selecting the item, press ▲▼◀▶ to set.

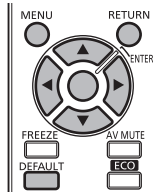

### Note

- When the input is set to DIGITAL LINK, only [KEYSTONE] can be set. When the optional digital interface box (ET-YFB100G) is connected to the projector, adjust the shift, aspect, and clock phase from the menu of ET-YFB100G.

## [SHIFT]

Move the image position vertically or horizontally if the image position projected on the screen is shifted even when the relative position of the projector and the screen is installed correctly.

- 1) Press ▲▼ to select [SHIFT].
- 2) Press the <ENTER> button.
  - The [SHIFT] screen is displayed.
- 3) Press ▲▼◀▶ to adjust the position.

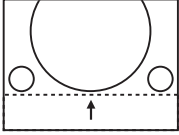
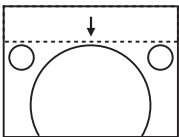
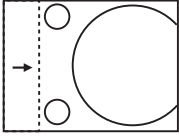
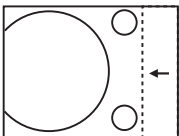
Orientation	Operation	Adjustment
Vertical (up and down) adjustment	Press the ▲ button.	The image position moves up. 
	Press the ▼ button.	The image position moves down. 
Horizontal (right and left) adjustment	Press the ▶ button.	The image position moves to the right. 
	Press the ◀ button.	The image position moves to the left. 

### Note

- For the portrait setting, image position is moved horizontally when “Vertical (up and down) adjustment” is made. Image position is moved vertically when “Horizontal (right and left) adjustment” is made.

## [ASPECT]

Switch the aspect ratio of the image.

The aspect ratio is switched within the screen range selected in [SCREEN SETTING]. Set [SCREEN SETTING] first. (➔ page 68)  
[SCREEN SETTING] can be set only on the PT-RW430E series.

- 1) Press ▲▼ to select [ASPECT].
- 2) Press ◀▶ or the <ENTER> button.
  - The [ASPECT] individual adjustment screen is displayed.
- 3) Press ◀▶ to switch [ASPECT].
  - The items will switch each time you press the button.

[NORMAL]	Displays images without changing the aspect ratio of the input signals.
[NATIVE]	Displays images without changing the resolution of the input signals.
[WIDE]	Displays images with the aspect ratio converted to 16:9 when standard signals are input*1. Display images without changing the aspect ratio when wide-screen signals are input*2.
[4:3]	Displays images without changing the aspect ratio when standard signals are input*1. Displays images without changing the aspect ratio so that the images will fit in the 4:3 screen when wide-screen signals are input*2.
[H FIT]	Displays images using the entire width of the screen. When signals have the aspect ratio vertically longer than the aspect ratio of the screen selected in [SCREEN FORMAT]*3, the images are displayed with the top and bottom parts cut off.
[V FIT]	Displays images using the entire height of the screen range selected in [SCREEN FORMAT]*3. When signals have the aspect ratio horizontally longer than the aspect ratio of the screen selected in [SCREEN FORMAT]*3, the images are displayed with the right and left parts cut off.
[FULL]	Displays images in the entire screen range selected in [SCREEN FORMAT]*3. When the aspect ratio of the input signals differs from that of the screen range, the images are displayed with the aspect ratio converted to that of the screen selected in [SCREEN FORMAT]*3.

\*1 Standard signals are input signals with an aspect ratio of 4:3 or 5:4.

\*2 Wide-screen signals are input signals with an aspect ratio of 16:10, 16:9, 15:9 or 15:10.

\*3 [SCREEN FORMAT] is not available for the PT-RZ470E series. The aspect ratio of the PT-RZ470E series is 16:9.

### Note

- If an aspect ratio which is different from the aspect ratio for the input signals is selected, the images will appear differently from the originals. Be careful of this when selecting the aspect ratio.
- If using the projector in places such as cafes or hotels to display programs for a commercial purpose or for public presentation, note that adjusting the aspect ratio or using the zoom function to change the screen images may be an infringement of the rights of the original copyright owner for that program under copyright protection laws. Take care when using a function of the projector such as the aspect ratio adjustment and zoom function.
- If conventional (normal) 4:3 images which are not wide-screen images are displayed on a wide screen, the edges of the images may not be visible or they may become distorted. Such images should be viewed as with an aspect ratio of 4:3 in the original format intended by the creator of the images.

## [ZOOM]

Adjust the image size.

### When [ASPECT] is set to other than [NORMAL] and [NATIVE]

- 1) Press ▲▼ to select [ZOOM].
- 2) Press the <ENTER> button.
  - The [ZOOM] screen is displayed.
- 3) Press ▲▼ to select [INTERLOCKED].
- 4) Press ◀▶ to switch [INTERLOCKED].

[OFF]	Sets the [VERTICAL] and [HORIZONTAL] zoom ratio.
[ON]	Uses [BOTH] to set zoom ratio. Image can be enlarged or reduced vertically and horizontally by units of 1.0 time.

- 5) Press ▲▼ to select [VERTICAL] or [HORIZONTAL].
  - If [ON] is selected, select [BOTH].
- 6) Press ◀▶ to adjust.

**Note**

- When [ASPECT] is set to [NATIVE], [ZOOM] cannot be adjusted.

**When [ASPECT] is set to [NORMAL]**

- 1) Press ▲▼ to select [ZOOM].
- 2) Press the <ENTER> button.
  - The [ZOOM] screen is displayed.
- 3) Press ▲▼ to select [MODE].
- 4) Press ◀▶ to switch [MODE].

[INTERNAL]	Enlarges the size within the aspect range set with [SCREEN FORMAT].
[FULL]	Enlarges or reduces the size using the entire display area set with [SCREEN FORMAT].

- 5) Press ▲▼ to select [INTERLOCKED].
- 6) Press ◀▶ to switch [INTERLOCKED].

[OFF]	Sets the [VERTICAL] and [HORIZONTAL] zoom ratio.
[ON]	Uses [BOTH] to set zoom ratio. Image can be enlarged or reduced vertically and horizontally by units of 1.0 time.

- 7) Press ▲▼ to select [VERTICAL] or [HORIZONTAL].
  - If [ON] is selected, select [BOTH].
- 8) Press ◀▶ to adjust.

**Note**

- When [ASPECT] is not set to [NORMAL], [MODE] is not displayed.

**[CLOCK PHASE]**

Adjust to achieve an optimal image when there is a flickering image or smeared outlines.

- 1) Press ▲▼ to select [CLOCK PHASE].
- 2) Press ◀▶ or the <ENTER> button.
  - The [CLOCK PHASE] individual adjustment screen is displayed.
- 3) Press ◀▶ to adjust.
  - Adjustment value will change between [0] and [31]. Adjust so that the amount of interference is at a minimum.

**Note**

- Optimal value may not be achieved if the output from the input computer is unstable.
- Optimal value may not be achieved when there is a shift in the total dot numbers.
- [CLOCK PHASE] can be adjusted only when an analog signal is input to the <COMPUTER IN> terminal or the <DVI-I IN> terminal.
- [CLOCK PHASE] cannot be adjusted when a digital signal is input.
- If you press ▶ while the adjustment value is [31], the value will become [0]. If you press ◀ while the adjustment value is [0], the value will become [31].



## [KEystone]

Correct the trapezoidal distortion that occurs when the projector is installed tilted or when the screen is tilted.

- 1) Press ▲▼ to select [KEYSTONE].
- 2) Press ◀▶ or the <ENTER> button.
  - The [KEYSTONE] individual adjustment screen is displayed.
- 3) Press ◀▶ to adjust.

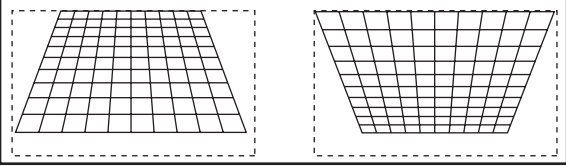
Item	Details
[KEYSTONE]	

### Note

- [KEYSTONE] can be corrected up to  $\pm 40^\circ$  for tilt in the vertical direction. However, the image quality will degrade and it will get harder to focus with more correction. Install the projector so the correction will be as small as possible.
- Performing [KEYSTONE] also changes the image size.
- Trapezoidal distortion may occur depending on the lens shift position.
- Aspect ratio of the image size may shift depending on the correction or lens zoom value.
- For the portrait setting, keystone is corrected for horizontal tilt.

## [ADVANCED MENU] menu

On the menu screen, select [ADVANCED MENU] from the main menu, and select the item from the sub-menu.

Refer to “Navigating through the menu” (→ page 44) for the operation of the menu screen.

- After selecting the item, press ▲▼◀▶ to set.

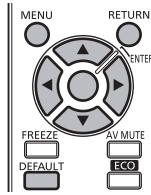

### [DIGITAL CINEMA REALITY]

Increase the vertical resolution and enhance the image quality by performing cinema processing when the PAL (or SECAM) 576i signal, the NTSC 480i signal, and 1080/50i, 1080/60i are input.

- 1) Press ▲▼ to select [DIGITAL CINEMA REALITY].
- 2) Press ◀▶ to switch [DIGITAL CINEMA REALITY].

- The items will switch each time you press the button.

[AUTO]	Performs automatic detection and cinema processing. (Factory default)
[OFF]	Does not perform cinema processing.

#### Note

- When [FRAME RESPONSE] is set to [FAST], [DIGITAL CINEMA REALITY] cannot be set.

### [BLANKING]

Adjust the blanking width if there are noises at the edge of the screen or the image is slightly running out from the screen while an image from the VCR or other devices are projected.

- 1) Press ▲▼ to select [BLANKING].
- 2) Press the <ENTER> button.
  - The [BLANKING] adjustment screen is displayed.
- 3) Press ▲▼ to select [UPPER], [LOWER], [LEFT], or [RIGHT].
- 4) Press ◀▶ to adjust the blanking.

- The adjustment range is within 10 % of the resolution in each direction, and changes depending on the input signal.

Blanking correction	Item	Operation	Adjustment	Range of adjustment	
Top of the screen	[UPPER]	Press the ◀ button.	The blanking zone moves upward.		Top and bottom: 0 (lower limit)
		Press the ▶ button.	The blanking zone moves downward.		
Bottom of the screen	[LOWER]	Press the ▶ button.	The blanking zone moves upward.		
		Press the ◀ button.	The blanking zone moves downward.		

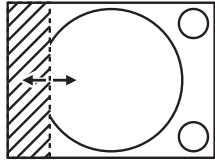
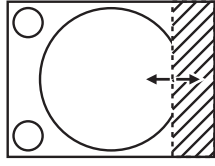
Blanking correction	Item	Operation	Adjustment	Range of adjustment	
Left side of the screen	[LEFT]	Press the ► button.	The blanking zone moves to the right.		Left and right: 0 (lower limit)
		Press the ◀ button.	The blanking zone moves to the left.		
Right side of the screen	[RIGHT]	Press the ◀ button.	The blanking zone moves to the right.		
		Press the ► button.	The blanking zone moves to the left.		

## [INPUT RESOLUTION]

Adjust to achieve an optimal image when there is a flickering image or smeared outlines.

- 1) Press ▲▼ to select [INPUT RESOLUTION].
- 2) Press the <ENTER> button.
  - The [INPUT RESOLUTION] screen is displayed.
- 3) Press ▲▼ to select [TOTAL DOTS], [DISPLAY DOTS], [TOTAL LINES], or [DISPLAY LINES], and press ◀▶ to adjust it.
  - Values corresponding to the signal being input are displayed automatically for each item. Increase or decrease the displayed values and adjust to the optimal point viewing the screen when there are vertical stripes or sections are missing from the screen.

### Note

- Previously mentioned vertical banding will not occur with all white signal input.
- The image may be disrupted while performing the adjustment, but it is not a malfunction.
- [INPUT RESOLUTION] can be adjusted only when an analog RGB signal is input to the <COMPUTER IN> terminal or the <DVI-I IN> terminal.
- Certain signals may not be adjustable.

## [CLAMP POSITION]

You can adjust the optimal point when the black part of the image is blunt or it has turned green.

- 1) Press ▲▼ to select [CLAMP POSITION].
- 2) Press ◀▶ to adjust.

Status	Rough guide for optimal value	Range of adjustment
The black part is blunt.	The point where bluntness of the black part improves the most is the optimal value.	1 - 255
The black part is green.	The point where the green part becomes black, and the bluntness has improved is the optimal value.	

### Note

- [CLAMP POSITION] can be adjusted only when an analog signal is input to the <COMPUTER IN> terminal or the <DVI-I IN> terminal.
- Certain signals may not be adjustable.

## [EDGE BLENDING]

The edge blending function allows multiple projector images to be seamlessly overlapped by using the inclination of the brightness at the overlapped area.

- 1) Press ▲▼ to select [EDGE BLENDING].
- 2) Press ◀▶ to switch [EDGE BLENDING].
  - The items will switch each time you press the button.

[OFF]	Sets the edge blending function to off.
[ON]	Sets the edge blending function to on.

- To adjust edge blending, proceed to Step 3).

- 3) When [ON] is selected, press the <ENTER> button.
  - The [EDGE BLENDING] screen is displayed.
- 4) Press ▲▼ to specify the location to be corrected.
  - When joining at top: Set [UPPER] to [ON]
  - When joining at bottom: Set [LOWER] to [ON]
  - When joining at left: Set [LEFT] to [ON]
  - When joining at right: Set [RIGHT] to [ON]
- 5) Press ◀▶ to switch [ON] and [OFF].
- 6) Press ▲▼ to select [START] and [WIDTH].
- 7) Press ◀▶ to adjust the starting position and correction width.
  - By setting [AUTO TESTPATTERN] on the [EDGE BLENDING] screen to [ON], the white test pattern is displayed when you enter the setting screen of starting point and correction width.
- 8) Press ▲▼ to select [MARKER].
- 9) Press ◀▶ to switch [ON].
  - A marker for image position adjustment is displayed. The position where the red and green lines overlap for the projectors to be joined will be the optimal point. Make sure to set the correction width for the projectors to be joined with the same value. Optimal joining is not possible with projectors that have different correction widths.

The optimal point is the point at which these lines overlap.

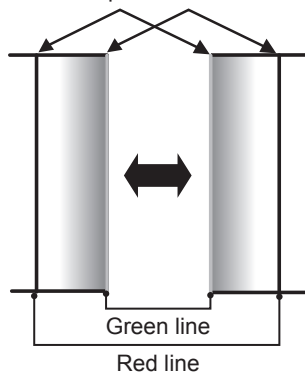

- 10) Press ▲▼ to select [BRIGHTNESS ADJUST].
- 11) Press the <ENTER> button.
  - The [BRIGHTNESS ADJUST] screen is displayed.
  - By setting [AUTO TESTPATTERN] on the [EDGE BLENDING] screen to [ON], the black test pattern is displayed when you enter the [BRIGHTNESS ADJUST] screen.
- 12) Press ▲▼ to select [NON-OVERLAPPED BLACK LEVEL].
- 13) Press the <ENTER> button.
  - The [NON-OVERLAPPED BLACK LEVEL] screen is displayed.
  - If [INTERLOCKED] is set to [OFF], [RED], [GREEN], and [BLUE] can be adjusted individually.
- 14) Press ▲▼ to select an item, and press ◀▶ to adjust the setting.
  - Once the adjustment is completed, press the <MENU> button to return to the [BRIGHTNESS ADJUST] screen.
- 15) Press ▲▼ to select [UPPER], [LOWER], [LEFT], and [RIGHT] in [BLACK BORDER WIDTH].
- 16) Press ◀▶ to set the region (width) of the [BLACK BORDER WIDTH] adjustment.
- 17) Press ▲▼ to select [BLACK BORDER LEVEL].
- 18) Press the <ENTER> button.
  - The [BLACK BORDER LEVEL] screen is displayed.
  - If [INTERLOCKED] is set to [OFF], [RED], [GREEN], and [BLUE] can be adjusted individually.

19) Press ▲▼ to select an item, and press ◀▶ to adjust the setting.

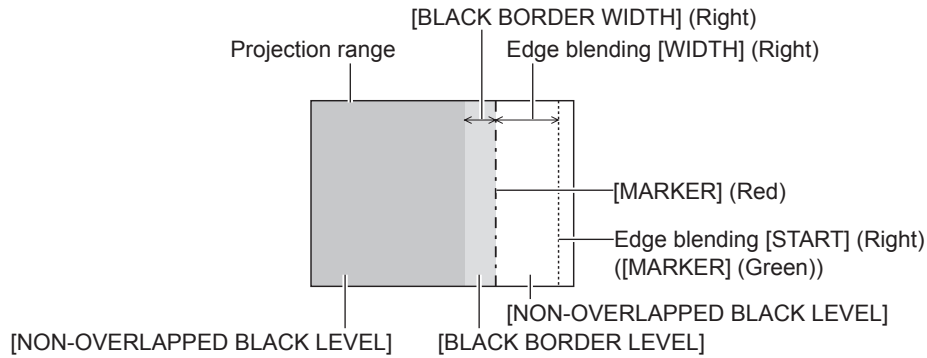

### Note

- [BRIGHTNESS ADJUST] is a function that makes the increased brightness in black level of the overlapping image area difficult to notice when [EDGE BLENDING] is used to configure multiple screens. The optimal point of correction is set by adjusting [NON-OVERLAPPED BLACK LEVEL] so the black level of the overlapping image area will be the same level as the non-overlapping area. If the border area of the part where the image is overlapping and the non-overlapping part gets brighter after adjusting [NON-OVERLAPPED BLACK LEVEL], adjust the width of the top, bottom, left, or right. Adjust [BLACK BORDER LEVEL] when the width adjustment makes only the border area darker.
- The joining part may look discontinuous depending on the position you are looking from when a screen with high gain or rear screen is used.
- When configuring multiple screens using both horizontal and vertical edge blending, adjust [OVERLAPPED BLACK LEVEL] first before making adjustments in Step 12). Adjustment method is same as the procedure of [NON-OVERLAPPED BLACK LEVEL].
- If only horizontal or vertical edge blending is used, set all items in [OVERLAPPED BLACK LEVEL] to 0.
- [AUTO TESTPATTERN] settings change together with the [AUTO TESTPATTERN] of [COLOR MATCHING].
- Depending on the resolution of the signal to be input, the line width of the marker is changed.
- When an interlaced signal is input or [NOISE REDUCTION] is set to [ON], the marker color may look pale.
- The [EDGE BLENDING] setting is not reflected in the internal test pattern.
- [EDGE BLENDING] cannot be selected if a signal is not being input.
- When using the edge blending function, inputting the signal of same resolution as DLP chips is recommended.
- The [EDGE BLENDING] setting is disabled when viewing 3D images.
- [EDGE BLENDING] cannot be selected when the VIDEO input is selected.
- When [PICTURE MODE] is set to [DYNAMIC], [EDGE BLENDING] cannot be selected.
- When [EDGE BLENDING] is set to [ON] while [NATURAL] is selected in [PICTURE MODE], the image may not be compliant to sRGB.
- When [EDGE BLENDING] is set to [ON] while [REC709] is selected in [PICTURE MODE], the image may not be compliant to Rec.709.
- When [EDGE BLENDING] is set to [ON] while [DICOM SIM.] is selected in [PICTURE MODE], the appearance of images may be different from DICOM standards.
- The following menu items cannot be selected when the edge blending function is in use.
  - [AUTO] in [DAYLIGHT VIEW] (➡ page 52)
  - [ECO SAVE1] and [ECO SAVE2] in [LIGHT POWER] (➡ page 77)
- The [AMBIENT LIGHT DETECTION] setting in [AUTO POWER SAVE] (➡ page 78) is disabled when the edge blending function is in use.
- For some interlaced signals, edge blending may not be adjusted appropriately.
- Depending on the settings of starting position and correction width of edge blending, the setting values of [START] and [WIDTH] may be automatically changed from original values when the image size is reduced using [ASPECT] or [ZOOM].

### [FRAME RESPONSE]

If 1 080/60i, 1 080/50i, or 1 080/24sF signals are input, the video frame delay can be shortened by simplifying video processing.

1) Press ▲▼ to select [FRAME RESPONSE].

2) Press ◀▶ to switch [FRAME RESPONSE].

- The items will switch each time you press the button.

[NORMAL]	Sets a priority on image quality.
[FAST]	Sets a limit to the time delay.

### Note

- Selecting [NORMAL] allows images to be viewed in higher quality.
- If the [NOISE REDUCTION] setting is [ON], [FRAME RESPONSE] cannot be set.
- [FRAME RESPONSE] cannot be set when viewing 3D videos.

## [RASTER POSITION]

---

This will allow the position of the image to move within the display area arbitrarily when the input image is not using the whole display area.

- 1) Press ▲▼ to select [RASTER POSITION].
- 2) Press the <ENTER> button.
  - The [RASTER POSITION] screen is displayed.
- 3) Press ▲▼◀▶ to adjust the position.

## [DISPLAY LANGUAGE] menu

On the menu screen, select [DISPLAY LANGUAGE] from the main menu, and display the sub-menu.

Refer to “Navigating through the menu” (➔ page 44) for the operation of the menu screen.

- Press ▲▼ to select a language, and press the <ENTER> button to set.

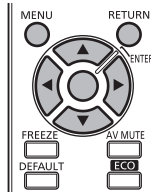

### Changing the display language

You can select the language of the on-screen display.



- Various menus, settings, adjustment screens, control button names, etc., are displayed in the selected language.
- The language can be changed to English, German, French, Italian, Spanish, Portuguese, Dutch, Swedish, Finnish, Norwegian, Danish, Polish, Hungarian, Romanian, Czech, Russian, Turkish, Arabic, Kazakh, Vietnamese, Chinese, Korean, Japanese, and Thai.

#### Note

- The on-screen display language of the projector is set to English by default and when [ALL USER DATA] (➔ page 91) of [INITIALIZE] is executed.

## [3D SETTINGS] menu

On the menu screen, select [3D SETTINGS] from the main menu, and select the item from the sub-menu.

Refer to “Navigating through the menu” (→ page 44) for the operation of the menu screen.

- After selecting the item, press ▲▼◀▶ to set.

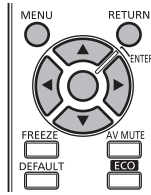

### [3D MODE]

Select a control method of the 3D eyewear for the 3D system in use.

- 1) Press ▲▼ to select [3D MODE].
- 2) Press ◀▶ to switch [3D MODE].
  - The items will switch each time you press the button.

[DLP Link]	Select this when viewing 3D images using 3D eyewear that supports DLP Link.
[3D SYNC]	Select this when viewing 3D images using VESA standard 3D eyewear.
[DLP Link + 3D SYNC]	Select this when viewing 3D images using both 3D eyewear that supports DLP Link and VESA standard 3D eyewear.
[OFF]	Disables the control of 3D eyewear.

#### Note

- When viewing 3D images, be sure to select the control method suitable for 3D eyewear in use.
- When viewing 3D images using VESA standard 3D eyewear, connect a compatible IR transmitter correctly.
- When [DLP Link] or [DLP Link + 3D SYNC] is selected in [3D MODE], the entire screen may look white.
- When selecting [DLP Link + 3D SYNC] in [3D MODE], 3D eyewear that supports DLP Link may not operate properly due to influence of control signals emitted from an IR transmitter, depending on installation environment. In such a case, try changing the installation location of an IR transmitter or viewing location.

### [3D SYNC OUTPUT DELAY]

Adjust the delay time if opening and closing timing of 3D eyewear shutter is not matched to the images. (when using VESA standard 3D eyewear)

- 1) Press ▲▼ to select [3D SYNC OUTPUT DELAY].
- 2) Press ◀▶ to adjust [3D SYNC OUTPUT DELAY].

Operation	Adjustment	Range of adjustment
Press the ◀ or ▶ button.	Changes in increments of 10 us.	0 us - 25 000 us

#### Note

- When [3D MODE] is set to [DLP Link] or [OFF], [3D SYNC OUTPUT DELAY] cannot be adjusted.
- Before adjusting [3D SYNC OUTPUT DELAY], display 3D images.

### [LEFT/RIGHT SWAP]

Display images by inverting the timing of horizontal image switching. Change the settings when there is something wrong with the 3D image being viewed.

#### When using 3D eyewear that supports DLP Link

- 1) Press ▲▼ to select [DLP Link].
- 2) Press ◀▶ to switch [DLP Link].
  - The items will switch each time you press the button.



[NORMAL]	Do not change the [NORMAL] setting if the 3D images are displayed correctly.
[SWAPPED]	Select this when left and right 3D images are swapped to be displayed.

**Note**

- When [3D MODE] is set to [3D SYNC] or [OFF], [DLP Link] cannot be set.
- Before changing the [DLP Link] setting, display 3D images.

**When using VESA standard 3D eyewear**

- 1) Press ▲▼ to select [3D SYNC].
- 2) Press ◀▶ to switch [3D SYNC].
  - The items will switch each time you press the button.

[NORMAL]	Do not change the [NORMAL] setting if the 3D images are displayed correctly.
[SWAPPED]	Select this when left and right 3D images are swapped to be displayed.

**Note**

- When [3D MODE] is set to [DLP Link] or [OFF], [3D SYNC] cannot be set.
- Before changing the [3D SYNC] setting, display 3D images.

**[3D INPUT FORMAT]**

Set the 3D format for the image signals being input.  
Set a 3D format that matches the input signal.

- 1) Press ▲▼ to select [3D INPUT FORMAT].
- 2) Press the <ENTER> button.
  - The [3D INPUT FORMAT] screen is displayed.
- 3) Press ▲▼ to select a 3D format.

[AUTO]*1	Automatically detects 3D format of input image signals and displays images.
[SIDE BY SIDE]	Forcibly displays 3D images in side by side format regardless of input image signals.
[TOP AND BOTTOM]	Forcibly displays 3D images in top and bottom format regardless of input image signals.
[FRAME SEQUENTIAL]	Forcibly displays 3D images in frame sequential format regardless of input image signals.
[NATIVE]	Forcibly displays 2D images regardless of input image signals.

\*1 Only for HDMI input/DIGITAL LINK input

- 4) Press the <ENTER> button.

**Note**

- This may not function properly for some connected external devices.

**[SAFETY PRECAUTIONS MESSAGE]**

Set to show or hide the safety precautions message related to 3D viewing when the projector is switched on.

- 1) Press ▲▼ to select [SAFETY PRECAUTIONS MESSAGE].
- 2) Press ◀▶ to switch [SAFETY PRECAUTIONS MESSAGE].
  - The items will switch each time you press the button.

[ON]	Shows the safety precautions message related to 3D viewing when the projector is switched on.
[OFF]	Hides the safety precautions message related to 3D viewing when the projector is switched on.

**Note**

- Set to [OFF] to hide the safety precautions message related to 3D viewing when the projector is switched on.
- A confirmation screen is displayed when switched from [ON] to [OFF]. Select [OK] on the confirmation screen and press the <ENTER> button to change the setting to [OFF].

**Attention**

- When 3D images are viewed by unspecified number of people for commercial use, display the safety precautions message related to 3D viewing to notify viewers.

## [3D SAFETY PRECAUTIONS]

Show the safety precautions message related to 3D viewing.

- 1) Press ▲▼ to select [3D SAFETY PRECAUTIONS].
- 2) Press the <ENTER> button.
  - The [3D SAFETY PRECAUTIONS] screen is displayed.
  - Press ◀▶ to switch the page.

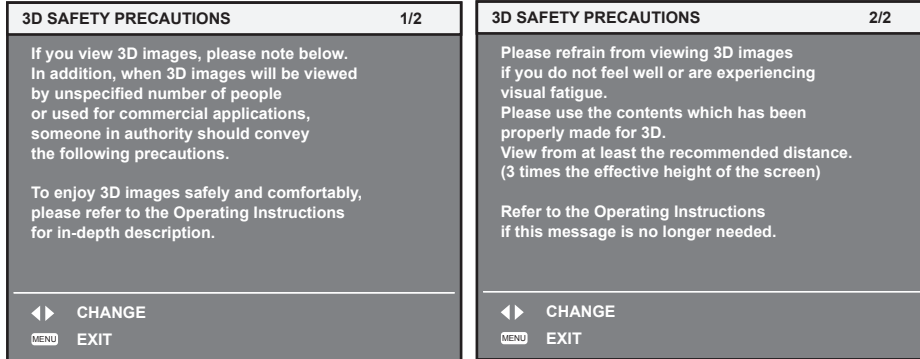

## [DISPLAY OPTION] menu

On the menu screen, select [DISPLAY OPTION] from the main menu, and select the item from the sub-menu.

Refer to “Navigating through the menu” (➔ page 44) for the operation of the menu screen.

- After selecting the item, press ▲▼◀▶ to set.

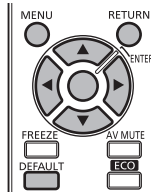

### [COLOR MATCHING]

Correct the color difference between projectors when using multiple projectors simultaneously.

#### Adjusting the color matching as desired

1) Press ▲▼ to select [COLOR MATCHING].

2) Press ◀▶ to switch [COLOR MATCHING].

- The items will switch each time you press the button.

[OFF]	Color matching adjustment is not carried out.
[3COLORS]	Adjusts the three colors [RED], [GREEN], or [BLUE].
[7COLORS]	Adjusts the seven colors [RED], [GREEN], [BLUE], [CYAN], [MAGENTA], [YELLOW], or [WHITE].
[MEASURED]	Refer to “Adjusting the color matching using a colorimeter” (➔ page 68) for details about this mode.

3) Select [3COLORS] or [7COLORS], and press the <ENTER> button.

- The [3COLORS] or [7COLORS] screen is displayed.

4) Press ▲▼ to select [RED], [GREEN], [BLUE], or [WHITE] ([RED], [GREEN], [BLUE], [CYAN], [MAGENTA], [YELLOW], or [WHITE] for [7COLORS]).

5) Press the <ENTER> button.

- The [3COLORS:RED], [3COLORS:GREEN], [3COLORS:BLUE], or [3COLORS:WHITE] screen is displayed.  
For [7COLORS], the [7COLORS:RED], [7COLORS:GREEN], [7COLORS:BLUE], [7COLORS:CYAN], [7COLORS:MAGENTA], [7COLORS:YELLOW], or [7COLORS:WHITE] screen is displayed.

6) Press ▲▼ to select [RED], [GREEN], or [BLUE].

- If [WHITE] is selected from [3COLORS], only [GAIN] can be adjusted.

7) Press ◀▶ to adjust.

- The adjustment value changes between 0 and 2 048\*1.

\*1 Depends on the signal input.

#### Note

- Operation when correcting the adjustment color  
When the correction color same as the adjustment color is changed: The luminance of the adjustment color changes.  
When correction color red is changed: Red is added to or subtracted from the adjustment color.  
When correction color green is changed: Green is added to or subtracted from the adjustment color.  
When correction color blue is changed: Blue is added to or subtracted from the adjustment color.
- This adjustment should be carried out by a person who is familiar with the projector or by a service person because a high level of skill is required to make a successful adjustment.
- Pressing the <DEFAULT> button will restore the factory default settings for all items.
- If [COLOR MATCHING] is set to other than [OFF], [COLOR TEMPERATURE] is fixed to [USER]. (However, [WHITE BALANCE HIGH] cannot be adjusted.)
- When “[PICTURE MODE]” (➔ page 49) is set to [DYNAMIC], [COLOR MATCHING] cannot be adjusted.

## Adjusting the color matching using a colorimeter

Use a colorimeter that can measure chromaticity coordinates and luminance to change the colors [RED], [GREEN], [BLUE], [CYAN], [MAGENTA], [YELLOW], or [WHITE] to desired colors.

- 1) Press ▲▼ to select [COLOR MATCHING].
- 2) Press ◀▶ to select [MEASURED].
- 3) Press the <ENTER> button.
  - The [MEASURED MODE] screen is displayed.
- 4) Press ▲▼ to select [MEASURED DATA].
- 5) Press the <ENTER> button.
  - The [MEASURED DATA] screen is displayed.
- 6) Measure the current luminance (Y) and the chromaticity coordinates (x, y) using the colorimeter.
- 7) Press ▲▼ to select a color, and press ◀▶ to adjust the setting.
- 8) Once all the input is completed, press the <MENU> button.
  - The [MEASURED MODE] screen is displayed.
- 9) Press ▲▼ to select [TARGET DATA].
- 10) Press the <ENTER> button.
  - The [TARGET DATA] screen is displayed.
- 11) Press ▲▼ to select a color and press ◀▶ to input coordinates for desired colors.
- 12) Once all the input is completed, press the <MENU> button.

### Note

- Colors are not displayed properly when target data is a color outside the region of this projector.
- Set the [AUTO TESTPATTERN] to [ON] to automatically display a test pattern for use in adjusting the selected adjustment colors.
- When using a colorimeter or similar instrument to measure measurement data, measure the colors displayed with [AUTO TESTPATTERN].
- A difference in the color coordinates of target data and measurement values obtained from an instrument may occur for certain instruments and measurement environments used.
- [AUTO TESTPATTERN] settings change together with the [AUTO TESTPATTERN] of [EDGE BLENDING].

## [SCREEN SETTING] (only for the PT-RW430E series)

Set the screen size.

When changing the aspect of a projected image, correct to the optimum image position for the set screen. Set as necessary for the screen in use.

- 1) Press ▲▼ to select [SCREEN SETTING].
- 2) Press the <ENTER> button.
  - The [SCREEN SETTING] screen is displayed.
- 3) Press ◀▶ to switch [SCREEN FORMAT].
  - The items will switch each time you press the button.

[SCREEN FORMAT]	Range when [SCREEN POSITION] is selected
[16:10]	Cannot be adjusted.
[16:9]	Adjusts the vertical position between -40 and 40.

- 4) Press ▲▼ to select [SCREEN POSITION].
  - When [SCREEN FORMAT] is set to [16:10], [SCREEN POSITION] is not displayed.
- 5) Press ◀▶ to adjust [SCREEN POSITION].

## [AUTO SIGNAL]

Set automatic execution of auto setup.

The screen display position or signal level can be adjusted automatically without pressing the <AUTO SETUP> button on the remote control on each occasion if you input unregistered signals frequently at meetings, etc.

1) Press ▲▼ to select [AUTO SIGNAL].

2) Press ◀▶ to switch [AUTO SIGNAL].

- The items will switch each time you press the button.

[OFF]	Sets input auto setup to off.
[ON]	Executes auto setup automatically when images are changed to unregistered signals during projection.

## [AUTO SETUP]

Set this when adjusting a special signal or horizontally long (such as 16:9) signal.

1) Press ▲▼ to select [AUTO SETUP].

2) Press the <ENTER> button.

- The [AUTO SETUP] screen is displayed.

3) Press ◀▶ to switch [MODE].

- The items will switch each time you press the button.

[DEFAULT]	Select when receiving a signal whose image aspect is 4:3 or 5:4. (Supported resolutions are 640 x 400, 640 x 480, 800 x 600, 832 x 624, 960 x 720, 1 024 x 768, 1 152 x 864, 1 152 x 870, 1 280 x 960, 1 280 x 1 024, 1 600 x 1 200, and 1 400 x 1 050)
[WIDE]	Select when receiving a signal whose image aspect is wide-screen. (Supported resolutions are 720 x 400, 848 x 480, 1 280 x 720, 1 024 x 600, 1 120 x 750, 1 440 x 900, and 1 680 x 1 050)
[USER]	Select when receiving a signal with a special horizontal resolution (number of display dots).

- When [DEFAULT] or [WIDE] is selected, proceed to Step 6).
- When [USER] is selected, proceed to Step 4).

4) Press ▲▼ to select [DISPLAY DOTS], and press ◀▶ to adjust [DISPLAY DOTS] to the horizontal resolution of the signal source.

5) Press ▲▼ to select [MODE].

6) Press the <ENTER> button.

- Automatic adjustment is executed. [PROGRESS] is displayed while automatically adjusting. When complete, the system returns to the [AUTO SETUP] screen.

## [COMPUTER IN]

Set to match the signal to input to the <COMPUTER IN> terminal.

1) Press ▲▼ to select [COMPUTER IN].

2) Press the <ENTER> button.

- The [COMPUTER IN] screen is displayed.

3) Press ◀▶ to switch [SYNC SLICE LEVEL].

- The items will switch each time you press the button.

[LOW]	Sets the slice level to [LOW].
[HIGH]	Sets the slice level to [HIGH].

**[DVI-I IN]**

Switch the setting when the external equipment is connected to the <DVI-I IN> terminal of the projector and the image is not projected correctly.

**When digital signals are input**

- 1) Press ▲▼ to select [DVI-I IN].
- 2) Press the <ENTER> button.
  - The [DVI-I IN] screen is displayed.
- 3) Press ▲▼ to select [DIGITAL/ANALOG].
- 4) Press ◀▶ to switch [DIGITAL].
- 5) Press ▲▼ to select [EDID].
- 6) Press ◀▶ to switch [EDID].
  - The items will switch each time you press the button.

[EDID3]	Recognizes movie-type image signals and still image-type signals automatically.
[EDID1]	Select mainly when an external device that outputs movie-type image signals (such as a blu-ray disk player) is connected to the <DVI-I IN> terminal.
[EDID2]	Select mainly when an external device that outputs still image-type signals (such as a computer) is connected to the <DVI-I IN> terminal.

- 7) Press ▲▼ to select [SIGNAL LEVEL].
- 8) Press ◀▶ to switch [SIGNAL LEVEL].
  - The items will switch each time you press the button.

[0-255:PC]	Select when an external device (such as a computer) is connected via the DVI terminal output.
[16-235]	Select when an external device (such as a blu-ray disc player) is connected via the HDMI terminal output using a conversion cable, etc.

**When analog signals are input**

- 1) Press ▲▼ to select [DVI-I IN].
- 2) Press the <ENTER> button.
  - The [DVI-I IN] screen is displayed.
- 3) Press ▲▼ to select [DIGITAL/ANALOG].
- 4) Press ◀▶ to switch [ANALOG].
- 5) Press ▲▼ to select [SYNC SLICE LEVEL].
- 6) Press ◀▶ to switch [SYNC SLICE LEVEL].
  - The items will switch each time you press the button.

[LOW]	Sets the slice level to [LOW].
[HIGH]	Sets the slice level to [HIGH].

**Note**

- The optimal setting is different depending on the output setting of the connected external equipment. Refer to the instruction manual of the external equipment regarding the output of the external equipment.
- The data for Plug and play will change when the setting is changed. Refer to "List of compatible signals" (▶ page 130) for a resolution that supports plug and play.

## [HDMI IN]

Switch the setting when the external equipment is connected to the <HDMI IN> terminal of the projector and the image is not projected correctly.

- 1) Press ▲▼ to select [HDMI IN].
- 2) Press the <ENTER> button.
  - The [HDMI IN] screen is displayed.
- 3) Press ◀▶ to switch [SIGNAL LEVEL].
  - The items will switch each time you press the button.

[AUTO]	Automatically sets the signal level.
[64-940]	Select when the HDMI terminal of an external device (such as a blu-ray disc player) is connected to the <HDMI IN> terminal.
[0-1023]	Select when the DVI terminal output of an external device (such as a computer) is connected to the <HDMI IN> terminal via a conversion cable or similar cable. Select also when the HDMI terminal output of a computer or other device is connected to the <HDMI IN> terminal.

### Note

- The optimal setting is different depending on the output setting of the connected external equipment. Refer to the instruction manual of the external equipment regarding the output of the external equipment.
- The HDMI signal level is displayed for every 30 bits of input.

## [DIGITAL LINK IN]

Set the signal level when DIGITAL LINK input is selected.

- 1) Press ▲▼ to select [DIGITAL LINK IN].
- 2) Press the <ENTER> button.
  - The [DIGITAL LINK IN] screen is displayed.
- 3) Press ◀▶ to switch [SIGNAL LEVEL].
  - The items will switch each time you press the button.

[AUTO]	Automatically sets the signal level.
[64-940]	Select when the HDMI terminal output of an external device (such as a blu-ray disc player) is connected to the <DIGITAL LINK/LAN> terminal via a twisted-pair-cable transmitter.
[0-1023]	Select this when the DVI terminal output or HDMI terminal output of an external device (such as a computer) is connected to the <DIGITAL LINK/LAN> terminal via a twisted-pair-cable transmitter.

### Note

- The optimal setting is different depending on the output setting of the connected external equipment. Refer to the instruction manual of the external equipment regarding the output of the external equipment.

## [ON-SCREEN DISPLAY]

Set the on-screen display.

### Setting [OSD POSITION]

Set the position of the menu screen (OSD).

- 1) Press ▲▼ to select [ON-SCREEN DISPLAY].
- 2) Press the <ENTER> button.
  - The [ON-SCREEN DISPLAY] screen is displayed.
- 3) Press ▲▼ to select [OSD POSITION].
- 4) Press ◀▶ to switch [OSD POSITION].
  - The items will switch each time you press the button.

[5]	Sets to the center of the screen.
[6]	Sets to the bottom center of the screen.

[7]	Sets to the upper right of the screen.
[8]	Sets to the center right of the screen.
[9]	Sets to the bottom right of the screen.
[1]	Sets to the upper left of the screen.
[2]	Sets to the center left of the screen.
[3]	Sets to the bottom left of the screen.
[4]	Sets to the top center of the screen.

### Setting [OSD DESIGN]

Set the color of the menu screen (OSD).

- 1) Press ▲▼ to select [ON-SCREEN DISPLAY].
- 2) Press the <ENTER> button.
  - The [ON-SCREEN DISPLAY] screen is displayed.
- 3) Press ▲▼ to select [OSD DESIGN].
- 4) Press ◀▶ to switch [OSD DESIGN].
  - The items will switch each time you press the button.

[1]	Sets to yellow.
[2]	Sets to blue.
[3]	Sets to white.
[4]	Sets to green.
[5]	Sets to peach.
[6]	Sets to brown.

### Setting [OSD MEMORY]

Set hold for the position of the menu screen (OSD) cursor.

- 1) Press ▲▼ to select [ON-SCREEN DISPLAY].
- 2) Press the <ENTER> button.
  - The [ON-SCREEN DISPLAY] screen is displayed.
- 3) Press ▲▼ to select [OSD MEMORY].
- 4) Press ◀▶ to switch [OSD MEMORY].
  - The items will switch each time you press the button.

[ON]	Holds the cursor position.
[OFF]	Does not hold the cursor position.

### Note

- Even if [OSD MEMORY] is [ON], the cursor position is not held when the projector is switched off and in standby mode.

### Setting [INPUT GUIDE]

Set whether to display the input guide (input terminal name, signal name, and memory number currently selected) in the position set in the [OSD POSITION].

- 1) Press ▲▼ to select [ON-SCREEN DISPLAY].
- 2) Press the <ENTER> button.
  - The [ON-SCREEN DISPLAY] screen is displayed.
- 3) Press ▲▼ to select [INPUT GUIDE].
- 4) Press ◀▶ to switch [INPUT GUIDE].
  - The items will switch each time you press the button.

[ON]	Displays the input guide.
[OFF]	Hides the input guide.



### Setting [WARNING MESSAGE]

Set the display/hide of the warning message.

- 1) Press ▲▼ to select [ON-SCREEN DISPLAY].
- 2) Press the <ENTER> button.
  - The [ON-SCREEN DISPLAY] screen is displayed.
- 3) Press ▲▼ to select [WARNING MESSAGE].
- 4) Press ◀▶ to switch [WARNING MESSAGE].
  - The items will switch each time you press the button.

[ON]	Displays the warning message.
[OFF]	Hides the warning message.

### [CLOSED CAPTION SETTING] (NTSC input only)

Set closed captions.

#### Selecting the closed caption display

- 1) Press ▲▼ to select [CLOSED CAPTION SETTING].
- 2) Press the <ENTER> button.
  - The [CLOSED CAPTION SETTING] screen is displayed.
- 3) Press ▲▼ to select [CLOSED CAPTION].
- 4) Press ◀▶ to switch [CLOSED CAPTION].
  - Switch to [OFF] or [ON].

[OFF]	Hides closed captions.
[ON]	Displays closed captions.

- When [ON] is selected, proceed to Step 5).

- 5) When the confirmation is displayed, select [OK] or [CANCEL], and press the <ENTER> button.

#### Setting the closed caption display

- 1) Press ▲▼ to select [CLOSED CAPTION SETTING].
- 2) Press the <ENTER> button.
  - The [CLOSED CAPTION SETTING] screen is displayed.
- 3) Press ▲▼ to select [MODE].
- 4) Press ◀▶ to switch [MODE].
  - The items will switch each time you press the button.

[CC1]	Displays CC1 data.
[CC2]	Displays CC2 data.
[CC3]	Displays CC3 data.
[CC4]	Displays CC4 data.

#### Note

- Closed captions are a function that is mainly used in North America to display text information with video signals. Captions may not be displayed depending on the connected devices or software being played back.
- [CLOSED CAPTION SETTING] can only be selected if an NTSC signal is input.
- If a closed caption signal of the selected mode is input, the security message and the ECO level (➡ page 79) are not displayed even when the [SECURITY] menu → [TEXT DISPLAY] (➡ page 96) is set to [ON].
- Closed captions are not displayed when the menu screen is displayed.

**[BACK COLOR]**

Set the display of the projected screen when there is no signal input.

1) Press ▲▼ to select [BACK COLOR].

2) Press ◀▶ to switch [BACK COLOR].

- The items will switch each time you press the button.

[BLUE]	Displays the entire projection area in blue.
[BLACK]	Displays the entire projection area in black.
[DEFAULT LOGO]	Displays the Panasonic logo.
[USER LOGO]	Displays the image registered by the user.

**Note**

- To create/register the [USER LOGO] image, use "Logo Transfer Software" included in the supplied CD-ROM.

**[STARTUP LOGO]**

Set the logo display when the power is turned on.

1) Press ▲▼ to select [STARTUP LOGO].

2) Press ◀▶ to switch [STARTUP LOGO].

- The items will switch each time you press the button.

[DEFAULT LOGO]	Displays the Panasonic logo.
[USER LOGO]	Displays the image registered by the user.
[NONE]	Disables the startup logo display.

**Note**

- The startup logo will disappear in approximately 15 seconds.
- To create/register the [USER LOGO] image, use "Logo Transfer Software" included in the supplied CD-ROM.

**[SUB MEMORY LIST]**

The projector has a sub memory function that can register the multiple image adjustment data, even if it is recognized as the same signal by the frequency or format of the synchronization signal source.

Use this function when you need to adjust the image quality such as switching of the aspect ratio or white balance by the same synchronization signal source. The sub memory includes all the data that can be adjusted for each signal, such as the screen aspect ratio and data adjusted in the [PICTURE] menu ([CONTRAST], [BRIGHTNESS], etc.).

**Registering the current settings to the list**

1) Press ▲▼ to select [SUB MEMORY LIST], and press the <ENTER> button.

- The sub memory registration screen is displayed if the sub memory is not registered. Proceed to Step 3).
- A list of sub memories registered to the signal currently input is displayed.
- [SUB MEMORY LIST] can be displayed by pressing ◀▶ on the normal screen (when the menu is not displayed).

2) Press ▲▼◀▶ to select the sub memory number to register in [SUB MEMORY LIST].

3) Press the <ENTER> button.

- The [RENAME] screen is displayed.

4) Press the <ENTER> button.

- To rename the registered signal, follow the procedure in Steps 4) and 5) in "Renaming the registered signal" (➔ page 93).

### Switching to the sub memory list

---

- 1) Press **▲▼** to select [SUB MEMORY LIST], and press the **<ENTER>** button.
  - A list of sub memories registered to the signal currently input is displayed.
  - [SUB MEMORY LIST] can be displayed by pressing **◀▶** on the normal screen (when the menu is not displayed).
- 2) Press **▲▼◀▶** to select the signal to switch in [SUB MEMORY LIST].
- 3) Press the **<ENTER>** button.
  - This switches to the signal selected in Step 2).

### Deleting the sub memory data

---

- 1) Press **▲▼** to select [SUB MEMORY LIST], and press the **<ENTER>** button.
  - The [SUB MEMORY LIST] screen is displayed.
  - [SUB MEMORY LIST] can be displayed by pressing **◀▶** on the normal screen (when the menu is not displayed).
- 2) Press **▲▼◀▶** to select the item to delete, and press the **<DEFAULT>** button.
  - The [ENTRY SIGNAL DELETE] screen is displayed.
  - To cancel deletion, press the **<RETURN>** button or the **<MENU>** button to return to the [SUB MEMORY LIST] screen.
- 3) Press the **<ENTER>** button.
  - The selected sub memory will be deleted.

### [FREEZE]

---

The projected image is paused temporarily and the sound stopped regardless of the playback of the external equipment.

- 1) Press **▲▼** to select [FREEZE].
- 2) Press the **<ENTER>** button.
  - Press the **<RETURN>** button to release.

#### Note

---

- [FREEZE] is displayed on the screen when video is paused.

### [AV MUTE]

---

Turn off audio and video when the projector is not used for a certain period of time.

- 1) Press **▲▼** to select [AV MUTE].
- 2) Press the **<ENTER>** button.
  - Press the **<RETURN>** button to release.

#### Note

---

- The power indicator **<ON (G)/STANDBY (R)>** flashes slowly when the projector is in AV mute mode.

## [PROJECTOR SETUP] menu

On the menu screen, select [PROJECTOR SETUP] from the main menu, and select the item from the sub-menu.

Refer to “Navigating through the menu” (➔ page 44) for the operation of the menu screen.

- After selecting the item, press ▲▼◀▶ to set.

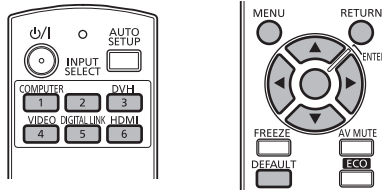

### [PROJECTOR ID]

The projector has an ID number setting function that can be used when multiple projectors are used side by side to enable simultaneous control or individual control via one remote control.

1) Press ▲▼ to select [PROJECTOR ID].

2) Press ◀▶ to switch [PROJECTOR ID].

- The items will switch each time you press the button.

[ALL]	Sets when controlling without specifying an ID number.
[1] - [6]	Sets when specifying and controlling an individual ID number.

#### Note

- The ID number can be set to [ALL], or from [1] to [6].
- To specify an ID number for individual control, the ID number of a remote control must match the ID number of the projector.
- When the ID number is set to [ALL], the projector will operate regardless of the ID number specified during remote control or computer control.  
If multiple projectors are set up side by side with IDs set to [ALL], they cannot be controlled separately from the projectors with other ID numbers.
- Refer to “Setting the remote control ID numbers” (➔ page 24) for how to set the ID number on the remote control.

### [PROJECTION METHOD]

Set the projection method in accordance with the installation status of the projector.

Change the projection method if the screen display is upside down or inverted.

1) Press ▲▼ to select [PROJECTION METHOD].

2) Press the <ENTER> button.

- The [PROJECTION METHOD] screen is displayed.

3) Press ▲▼ to select the projection method.

[FRONT/FLOOR]	When installing on the desk, etc., in front of the screen
[FRONT/CEILING]	When installing using the ceiling mount bracket (optional accessories) in front of the screen
[REAR/FLOOR]	When installing on the desk, etc., behind the screen (using a translucent screen)
[REAR/CEILING]	When installing using the ceiling mount bracket (optional accessories) behind the screen (using a translucent screen)

4) Press the <ENTER> button.

5) When the confirmation is displayed, select [OK] or [CANCEL], and press the <ENTER> button.

#### Attention

- When [PROJECTION METHOD] is changed, confirm that [COOLING CONDITION] (➔ page 77) is set correctly.

## [COOLING CONDITION]

Change the fan control depending on the direction of projection.

Set [COOLING CONDITION] correctly in accordance with the direction of projection referencing the following figure. Using the light source with incorrect settings may shorten its life.

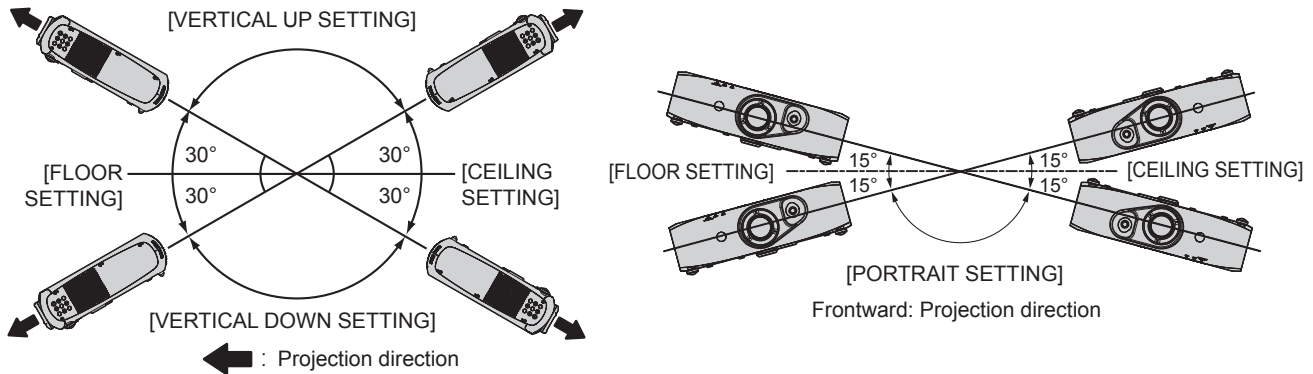

- 1) Press ▲▼ to select [COOLING CONDITION].
- 2) Press the <ENTER> button.
  - The [COOLING CONDITION] screen is displayed.
- 3) Press ▲▼ to select a cooling condition.
- 4) Press the <ENTER> button.
- 5) When the confirmation is displayed, select [OK] or [CANCEL], and press the <ENTER> button.

## [HIGH ALTITUDE MODE]

Set to [ON] when using the projector at high altitudes between 1 400 m (4 593') and 2 700 m (8 858') above sea level.

- 1) Press ▲▼ to select [HIGH ALTITUDE MODE].
- 2) Press ◀▶ to switch the item.

[OFF]	When using at a location lower than 1 400 m (4 593') above sea level
[ON]	When using at high altitudes (between 1 400 m (4 593') and 2 700 m (8 858') above sea level)

- 3) When the confirmation screen is displayed, press ◀▶ to select [OK] or [CANCEL], and press the <ENTER> button.

### Note

- The speed of the fan increases and the operation sound becomes louder when set to [ON].

## [ECO MANAGEMENT]

A function that optimizes the light source power to suit usage conditions to reduce power consumption.

### Setting [LIGHT POWER]

- 1) Press ▲▼ to select [ECO MANAGEMENT].
- 2) Press the <ENTER> button.
  - The [ECO MANAGEMENT] screen is displayed.
- 3) Press ▲▼ to select [LIGHT POWER].
- 4) Press ◀▶ to switch [LIGHT POWER].
  - The items will switch each time you press the button.

[NORMAL]	Sets when high luminance is required.
[ECO SAVE1]	Reduces the power by approximately 20 % in average compared to [NORMAL] without affecting the brightness.

[ECO SAVE2]	Reduces the power by approximately 30 % in average compared to [NORMAL], minimizing reduction in brightness.
[LOW]	Sets this when you want to save more power without the need for high brightness.

**Note**

- The rate of power consumption reduction when the eco save mode is set refers to the ratio of average power consumption when a “Broadcast” video signal that complies with IEC62087 is projected.
- When [ECO SAVE1] and [ECO SAVE2] is set, the image may appear differently to [NORMAL].
- If you feel that the brightness has decreased with [ECO SAVE2], switching to [ECO SAVE1] may improve the image.
- When [LOW] is set, the operating noise can be reduced.
- When the VIDEO input is selected, [ECO SAVE1] and [ECO SAVE2] cannot be selected. When [ECO SAVE1] or [ECO SAVE2] is set while selecting other than VIDEO input, and when the VIDEO input is selected, [LOW] is set.
- When [NATURAL] is selected in [PICTURE MODE], and [ECO SAVE1] or [ECO SAVE2] is selected in [LIGHT POWER], the image may not conform to sRGB standards.
- When [REC709] is selected in [PICTURE MODE], and [ECO SAVE1] or [ECO SAVE2] is selected in [LIGHT POWER], the image may not conform to Rec.709 standards.
- When [DICOM SIM.] is selected in [PICTURE MODE], and [ECO SAVE1] or [ECO SAVE2] is selected in [LIGHT POWER], the image may appear different from the image of DICOM standards.
- Cannot be selected when viewing 3D videos. This is fixed to [NORMAL].

**Setting [AUTO POWER SAVE]**

Set whether to enable the three functions [AMBIENT LIGHT DETECTION], [SIGNAL DETECTION], and [AV MUTE DETECTION].

- 1) Press ▲▼ to select [ECO MANAGEMENT].
- 2) Press the <ENTER> button.
  - The [ECO MANAGEMENT] screen is displayed.
- 3) Press ▲▼ to select [AUTO POWER SAVE].
- 4) Press ◀▶ to switch [AUTO POWER SAVE].
  - The items will switch each time you press the button.

[ON]	Enables power-saving mode.
[OFF]	Disables power-saving mode.

- 5) Press ▲▼ to select [AMBIENT LIGHT DETECTION], [SIGNAL DETECTION], or [AV MUTE DETECTION].

[AMBIENT LIGHT DETECTION]	Adjusts the light source power depending on the brightness of the location of the projector.
[SIGNAL DETECTION]	Reduces the power of the light source when there is no signal.
[AV MUTE DETECTION]	Reduces the power of the light source in AV mute mode.

- 6) Press ◀▶ to switch the setting of [AMBIENT LIGHT DETECTION], [SIGNAL DETECTION], or [AV MUTE DETECTION].
  - The items will switch each time you press the button.

[ON]	Enables the setting.
[OFF]	Disables the setting.

**Note**

- When [AUTO POWER SAVE] is [OFF], [AMBIENT LIGHT DETECTION], [SIGNAL DETECTION], and [AV MUTE DETECTION] cannot be set.
- [AMBIENT LIGHT DETECTION] cannot be selected when viewing 3D videos. This is fixed to [OFF].

**Setting [NO SIGNAL SHUT-OFF]**

A function that automatically switches the power source of the projector to standby if there is no input signal for a certain period of time. The time before switching to standby can be set.

- 1) Press ▲▼ to select [ECO MANAGEMENT].
- 2) Press the <ENTER> button.
  - The [ECO MANAGEMENT] screen is displayed.

3) Press ▲▼ to select [NO SIGNAL SHUT-OFF].

4) Press ◀▶ to switch [NO SIGNAL SHUT-OFF].

- The items will switch each time you press the button.

[DISABLE]	Disables the No signal shut-off function.
[10MIN.] - [90MIN.]	Sets the time in 10-minute intervals.

### Setting [STANDBY MODE]

Set the power consumption during the standby.

1) Press ▲▼ to select [ECO MANAGEMENT].

2) Press the <ENTER> button.

- The [ECO MANAGEMENT] screen is displayed.

3) Press ▲▼ to select [STANDBY MODE].

4) Press ◀▶ to switch [STANDBY MODE].

- The items will switch each time you press the button.

[ECO]	Use this setting to reduce power consumption during standby.
[NORMAL]	Use this setting to use the network function during standby.

### Note

- When set to [ECO], network functions are not available during standby. Also, some RS-232C commands are not available. When set to [NORMAL], network functions are available during standby.
- If set to [ECO], there may be a delay in displaying when the power is turned on compared to when set to [NORMAL].

### Setting [ECO LEVEL DISPLAY]

Display the amount of power saved through the [LIGHT POWER] and [AUTO POWER SAVE] settings on the lower left corner of the projected screen.

The more the number of green leaf marks (  ) the more power the projector saves.

Screen display example:



1) Press ▲▼ to select [ECO MANAGEMENT].

2) Press the <ENTER> button.

- The [ECO MANAGEMENT] screen is displayed.

3) Press ▲▼ to select [ECO LEVEL DISPLAY].

4) Press ◀▶ to switch [ECO LEVEL DISPLAY].

- The items will switch each time you press the button.

[OFF]	Disables the ECO level display.
[ON]	Enables the ECO level display.

### Note

- If a closed caption signal of the selected mode is input, ECO level is not displayed.
- The ECO level is not displayed when the menu screen is displayed.

### [BRIGHTNESS CONTROL]

The projector has a built-in brightness sensor which measures the brightness of the light source and has a function which corrects the brightness of the screen according to the change in the brightness of the light source.

The light source deteriorates over time. By using this function, you can reduce the change in overall brightness or keep it uniform by suppressing the variation in brightness when displaying multiple screens using multiple projectors.

### Note

- If [DYNAMIC] is selected in the [PICTURE] menu → [PICTURE MODE], [BRIGHTNESS CONTROL] cannot be selected.

### Setting [BRIGHTNESS CONTROL GAIN]

Adjust the brightness when displaying multiple screens using multiple projectors.

- 1) Press ▲▼ to select [BRIGHTNESS CONTROL].
- 2) Press the <ENTER> button.
  - The [BRIGHTNESS CONTROL] screen is displayed.
- 3) Press ▲▼ to select [BRIGHTNESS CONTROL GAIN].
- 4) Press ◀▶ to adjust.

Operation	Adjustment		Range of adjustment
	Brightness	Maximum amount of brightness correction	
Press the ▶ button.	The screen becomes brighter.	The maximum amount of correction is reduced.	20 - 100 %
Press the ◀ button.	The screen becomes darker.	The maximum amount of correction is increased.	

#### Note

- When using only one projector, the value obtained by subtracting the value of the [BRIGHTNESS CONTROL GAIN] from 100 % is the maximum amount of brightness correction. Brightness cannot be corrected through brightness control since the maximum amount of correction becomes 0 % when [BRIGHTNESS CONTROL GAIN] is at 100 %.
- Brightness is not stable for 15 minutes after the light source lights up. Make adjustments at least 15 minutes after starting projection.
- The result of [BRIGHTNESS CONTROL GAIN] adjustments is reflected on all image signals, internal test patterns, and on-screen menus.
- The [BRIGHTNESS CONTROL GAIN] setting is enabled even if [BRIGHTNESS CONTROL SETUP] is [OFF].

### Setting [BRIGHTNESS CONTROL SETUP]

Set brightness control operation.

- 1) Press ▲▼ to select [BRIGHTNESS CONTROL].
- 2) Press the <ENTER> button.
  - The [BRIGHTNESS CONTROL] screen is displayed.
- 3) Press ▲▼ to select [BRIGHTNESS CONTROL SETUP].
- 4) Press the <ENTER> button.
  - The [BRIGHTNESS CONTROL SETUP] screen is displayed.
- 5) Press ▲▼ to select [MODE].
- 6) Press ◀▶ to switch [MODE].
  - The items will switch each time you press the button.

[OFF]	Does not correct the brightness of the screen by the brightness sensor.
[AUTO]	Corrects the brightness of the screen by the brightness sensor. When the brightness of the light source changes, the brightness of the screen is automatically corrected.
[PC]	Synchronizes nine or more projectors through a computer using the dedicated software "Multi Projector Monitoring & Control Software"*1.

\*1 "Multi Projector Monitoring & Control Software" is included in the supplied CD-ROM.

- When [AUTO] is selected, proceed to Step 7).

- 7) Press ▲▼ to select [LINK].
- 8) Press ◀▶ to switch [LINK].
  - The items will switch each time you press the button.

[OFF]	Performs corrections by the brightness sensor in one projector without synchronizing with the other projectors. The period, in which the constant brightness kept by the small value of [BRIGHTNESS CONTROL GAIN], is prolonged.
-------	---



[GROUP A] [GROUP B] [GROUP C] [GROUP D]	Synchronizes corrections in multiple projectors by the brightness sensor. You can set up to four groups (A to D) within the same subnet by using the network function. You can also register and synchronize up to eight projectors in one group.
--	---

9) Press ▲▼ to select [CALIBRATION TIME].

10) Press the <ENTER> button.

11) Press ◀▶ to select the hour and minute, press ▲▼ to set the time, and press the <ENTER> button.

- If you do not specify the time, select [OFF] between 23 and 00 o'clock or between 59 and 00 minutes.
- Brightness is measured at the specified time. During measurement, [LIGHT POWER] in [ECO MANAGEMENT] is fixed to [NORMAL]. Also, [AUTO POWER SAVE] is fixed to [OFF].

12) Press ▲▼ to select [CALIBRATION MESSAGE].

13) Press ◀▶ to switch [CALIBRATION MESSAGE].

- The items will switch each time you press the button.

[ON]	Messages are displayed during calibration.
[OFF]	Messages are not displayed during calibration.

14) Press ▲▼ to select [APPLY].

15) Press the <ENTER> button.

- The specified [MODE] and [LINK] is enabled. Afterwards, if [CALIBRATION MESSAGE] is [ON], messages during calibration is displayed. The display automatically disappears 30 seconds after calibration has been completed.
- If the <ENTER> button is pressed with [MODE] in [BRIGHTNESS CONTROL SETUP] set to other than [OFF], the light source brightness at the time the button was pressed is recorded as the standard brightness.
- If the <ENTER> button is pressed when [LINK] is set from [GROUP A] to [GROUP D], the group name is displayed on the screens of projectors that have been set in the same group.



### Note

- When [MODE] in [BRIGHTNESS CONTROL SETUP] is running with [AUTO] or [PC], the light source brightness is automatically measured 15 minutes after the light source lights up, and correction is performed so that the screen brightness will be the same as the standard brightness when the brightness control is adjusted. Brightness is not measured since the light source brightness is not stable for approximately 15 minutes after the light source lights up.
- When [MODE] of [BRIGHTNESS CONTROL SETUP] is running in [AUTO] and [LINK] is [OFF], the brightness will be corrected until it reaches the maximum amount of correction.
- The variation in brightness may increase due to dust accumulating on the lens, screen, or inside the projector, depending on the installation environment of the projector.
- When the variation in brightness has increased due to the deterioration of the light source over time, or when you replaced the light source unit, readjust the brightness control.
- When the projector is used continuously for more than 24 hours, set the [CALIBRATION TIME] in [BRIGHTNESS CONTROL SETUP]. If it is not set, correction will not be performed automatically.
- The brightness control and the ECO management operate simultaneously. However, [LIGHT POWER] in [ECO MANAGEMENT] is fixed to [NORMAL] while the brightness is measured. Also, [AUTO POWER SAVE] is fixed to [OFF].
- The set changes in the [CALIBRATION TIME] will be reflected during the time you entered.
- The set changes in the [CALIBRATION MESSAGE] will be reflected at the time items are switched using ◀▶.

### Setting [BRIGHTNESS CONTROL STATUS]

Display the brightness control status.

1) Press ▲▼ to select [BRIGHTNESS CONTROL].

2) Press the <ENTER> button.

- The [BRIGHTNESS CONTROL] screen is displayed.

3) Press ▲▼ to select [BRIGHTNESS CONTROL STATUS].

4) Press the <ENTER> button.

- The [BRIGHTNESS CONTROL STATUS] screen is displayed.

**[BRIGHTNESS CONTROL STATUS] screen display example**

When [MODE] of [BRIGHTNESS CONTROL SETUP] is set to [OFF]

The screen shows the status that the brightness control is disabled.

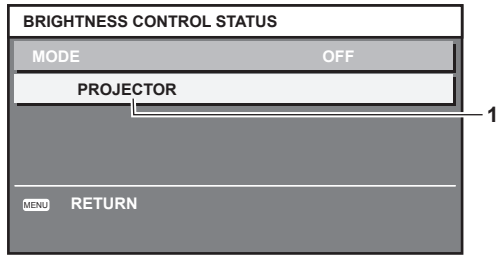

When [MODE] of [BRIGHTNESS CONTROL SETUP] is set to [AUTO] and [LINK] is set to [OFF]

The screen shows the status of the brightness control in one projector

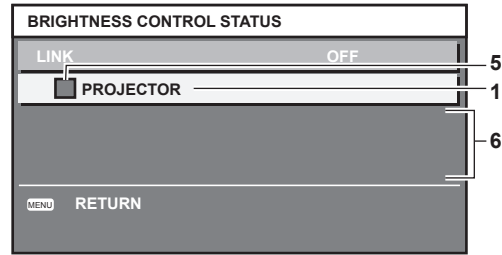

When [MODE] of [BRIGHTNESS CONTROL SETUP] is set to [AUTO] and [LINK] is set from [GROUP A] to [GROUP D]

The screen shows the status of the brightness control of synchronized projectors (up to eight units), including the projector being controlled through the on-screen menu.

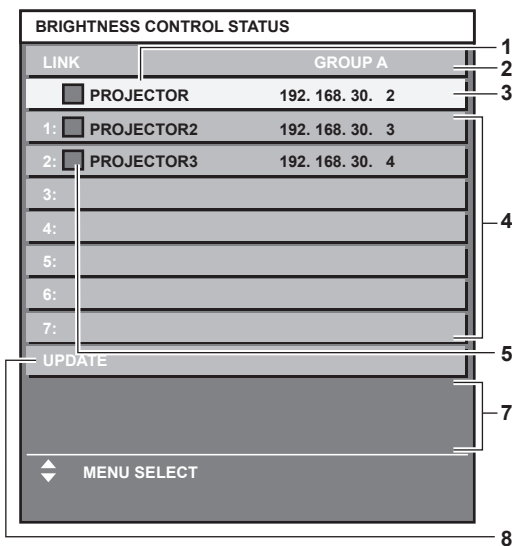

When [MODE] of [BRIGHTNESS CONTROL SETUP] is set to [PC]

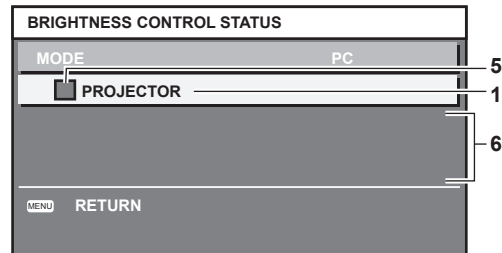

- 1 Display the name of the projector.
- 2 Display the synchronized group.
- 3 Display the IP address of the projector.
- 4 Display the names and IP addresses of projectors in same group detected over the network.
- 5 Display the status by color.  
Green: There is an allowance for brightness correction.  
Yellow: There is little allowance for brightness correction.  
Red: There is a brightness control error.

- 6 Display error detailed messages.
- 7 Display error messages.  
When the message [Failed to apply BRIGHTNESS CONTROL to some projectors.] appears, it means that synchronization with the projector displayed in red has failed.  
Press ▲▼ to select the projector displayed in red, and press the <ENTER> button to display the error details.
- 8 Update to the latest status information.

**■ Error details**

Error message	Measures to take
[Exceed maximum number of projectors.]	<ul style="list-style-type: none"> <li>• Limit the number of projectors in one group to eight.</li> <li>• When synchronizing nine or more projectors, use the dedicated software “Multi Projector Monitoring &amp; Control Software”<sup>*1</sup> through a computer.</li> </ul>
[Please check the COMMAND CONTROL setting.]	<ul style="list-style-type: none"> <li>• Set [COMMAND CONTROL] in [NETWORK CONTROL] of the projector displaying an error to [ON].</li> <li>• Assign the same value to [COMMAND PORT] of the [NETWORK CONTROL] of all projectors to be synchronized.</li> </ul>
[Please check the USER NAME and PASSWORD in the COMMAND CONTROL setting.]	<ul style="list-style-type: none"> <li>• Assign the same [User name] and [Password] strings of the web control administrator rights of all projectors to be synchronized.</li> </ul>
[Cannot apply BRIGHTNESS CONTROL. Please check projector status.]	<ul style="list-style-type: none"> <li>• The projector is in standby. Switch on the power.</li> </ul>

Error message	Measures to take
[Brightness Sensor Error]	<ul style="list-style-type: none"> <li>• There is a problem with the brightness sensor. If problems persist even after switching the power on, consult your dealer.</li> </ul>

\*1 "Multi Projector Monitoring & Control Software" is included in the supplied CD-ROM.

### Note

- If the synchronized projectors are not displayed in the list, check the following:
  - Are there devices with the same IP address on the network?
  - Are the LAN cables connected correctly? (➔ page 100)
  - Are the subnets of the projectors the same?
  - Are the same [LINK] settings applied to a group?
- Refer to "[NETWORK SETUP]" (➔ page 99) or "[Network config] page" (➔ page 107) on how to change the projector name.

### Brightness control adjustment procedure example

This is an example of an adjustment procedure for synchronizing the brightness of eight projectors connected to the network.

- 1) **Connect all projectors to the hub using LAN cables.** (➔ page 100)
- 2) **Switch on all projectors and start projection.**
- 3) **Set [MODE] of [BRIGHTNESS CONTROL SETUP] to [OFF], and select [APPLY], and then press the <ENTER> button.**
- 4) **Set [SUBNET MASK] and [IP ADDRESS] in each projector.**
  - To be able to communicate over the network, set the same value in [SUBNET MASK] for all projectors and set a different value in [IP ADDRESS] for each projector.
- 5) **Wait for at least 15 minutes after starting projection until the light source brightness stabilizes.**
- 6) **Set the same value in all items inside the [PICTURE] menu for all projectors.**
- 7) **Adjust [COLOR MATCHING] to match colors.**
- 8) **Display the internal test pattern "All white" in all projectors.**
- 9) **Set [BRIGHTNESS CONTROL GAIN] to 100 % in all projectors.**
- 10) **Set [BRIGHTNESS CONTROL GAIN] to 90 % in the projector with the least brightness.**
- 11) **Adjust [BRIGHTNESS CONTROL GAIN] in each projector.**
  - Adjust [BRIGHTNESS CONTROL GAIN] of all the other projectors so that the brightness is matched to the projector of which [BRIGHTNESS CONTROL GAIN] is set to 90 %.
- 12) **Set [MODE] of [BRIGHTNESS CONTROL SETUP] to [AUTO], and [LINK] to [GROUP A] in all projectors.**
- 13) **Select [APPLY] of [BRIGHTNESS CONTROL SETUP] and press the <ENTER> button in all projectors.**
  - Brightness control starts.

### Note

- Brightness is automatically corrected whenever the light source lights up by switching on/off the projector, etc.
- When the variation in brightness has increased, or when you replace the light source unit, readjust the brightness control.

### [SCHEDULE]

Set the command execution schedule for each day of the week.

### Enabling/disabling the schedule function

- 1) **Press ▲▼ to select [SCHEDULE].**
- 2) **Press ◀▶ to switch [SCHEDULE].**
  - The items will switch each time you press the button.

[OFF]	Disables the schedule function.
[ON]	Enables the schedule function. Refer to "How to assign a program" (➔ page 84) or "How to set a program" (➔ page 84) for how to set the schedule.

**Note**

- When [SCHEDULE] is set to [ON], the [STANDBY MODE] setting is forcibly switched to [NORMAL], and the setting cannot be changed. Even if [SCHEDULE] is then set to [OFF] when in this state, the setting of [STANDBY MODE] remains at [NORMAL].

**How to assign a program**

- 1) Press ▲▼ to select [SCHEDULE].
- 2) Press ◀▶ to select [ON], and press the <ENTER> button.
  - The [SCHEDULE] screen is displayed.
- 3) Select and assign program to each day of week.
  - Press ▲▼ to select the day of week, and press ◀▶ to select a program number.
  - You can set the program from No.1 to No.7. “- -” indicates that the program number has not been set.

**How to set a program**

Set up to 16 commands to each program.

- 1) Press ▲▼ to select [SCHEDULE].
- 2) Press ◀▶ to select [ON], and press the <ENTER> button.
  - The [SCHEDULE] screen is displayed.
- 3) Press ▲▼ to select [PROGRAM EDIT].
- 4) Press ◀▶ to select a program number, and press the <ENTER> button.
- 5) Press ▲▼ to select a command number, and press the <ENTER> button.
  - You can change the page using ◀▶.
- 6) Press ▲▼ to select [TIME], and press the <ENTER> button.
- 7) Press ◀▶ to select the hour and minute, press ▲▼ to set the time, and then press the <ENTER> button.
- 8) Press ▲▼ to select [COMMAND].
- 9) Press ◀▶ to switch [COMMAND].
  - The items will switch each time you press the button.
  - For the detailed settings of [COMMAND], the details set in Step 11) are displayed.

[COMMAND]	Detailed settings of [COMMAND]	Description
[POWER ON]	—	Switches on the projector.
[STANDBY]	—	Enters standby.
[AV MUTE]	[OFF]	Disables the AV mute function.
	[ON]	Turns off the audio and video.
[INPUT]	[COMPUTER]	Switches the input to COMPUTER.
	[VIDEO]	Switches the input to VIDEO.
	[DVI-I]	Switches the input to DVI-I.
	[HDMI]	Switches the input to HDMI.
[DIGITAL LINK INPUT]	[DIGITAL LINK]	Sets the input to DIGITAL LINK.
	[CURRENT]	Switches to DIGITAL LINK input with the currently selected connection. Can only be selected when [INPUT] is set to [DIGITAL LINK].
[LIGHT POWER]	[INPUT1] - [INPUT10] <sup>1</sup>	Switches to DIGITAL LINK input, and that input switches to the specified input when the Panasonic twisted-pair-cable transmitter is connected. Can only be selected when [INPUT] is set to [DIGITAL LINK].
	[NORMAL]	Prioritizes brightness.
	[ECO SAVE1]	Reduces the power by approximately 20 % in average compared to [NORMAL] without affecting the brightness.
	[ECO SAVE2]	Reduces the power by approximately 30 % in average compared to [NORMAL], minimizing reduction in brightness.
	[LOW]	Saves more power and reduces brightness.

[COMMAND]	Detailed settings of [COMMAND]	Description
[IN STANDBY MODE(AUDIO)]	[OFF]	Turns off audio output during standby.
	[ON]	Turns on audio output during standby.
[VOLUME]	[0] - [63]	Sets the volume.

\*1 When the Panasonic twisted-pair-cable transmitter (such as the optional digital interface box (Model No.: ET-YFB100G)) is connected to the projector, its input name is reflected from [INPUT1] to [INPUT10] automatically. If an item where the input name is not reflected is selected, it is disabled.

**10) Press the <ENTER> button.**

- The [COMMAND] detailed screen is displayed.

**11) Press ▲▼ to select a [COMMAND].**

- For [COMMAND] which requires detailed settings, the items of the detailed settings will switch each time you press ◀▶.

**12) Press the <ENTER> button.**

- The command is fixed and ● is displayed at the left of the selected command.
- After the command is fixed, press the <RETURN> button or the <MENU> button to close the detailed setting menu.

**13) Press ▲▼ to select [STORE], and press the <ENTER> button.**

**Note**

- When deleting commands that have already been set, press the <DEFAULT> button on the screen displayed in step 5).
- If multiple commands have been set for the same time, they are executed in chronological order starting from the smallest command number.
- The operating time will be the local time. (➔ page 90)
- If an operation is executed with the remote control or control panel of the projector or with a control command before the command set in [SCHEDULE] is executed, the command set with this function may not be executed.

**[INITIAL STARTUP]**

Set the startup method when the <MAIN POWER> switch is set to <ON>.

**1) Press ▲▼ to select [INITIAL STARTUP].**

**2) Press ◀▶ to switch [INITIAL STARTUP].**

- The items will switch each time you press the button.

[LAST MEMORY]	Starts the projector in the condition before the <MAIN POWER> switch is set to <OFF>.
[STANDBY]	Starts in standby.
[ON]	Starts projecting immediately.

**[STARTUP INPUT SELECT]**

Set the input when the projector is switched on to start projection.

**1) Press ▲▼ to select [STARTUP INPUT SELECT].**

**2) Press ◀▶ to switch [STARTUP INPUT SELECT].**

- The items will switch each time you press the button.

[LAST USED]	Keeps the input selected last.
[COMPUTER]	Sets the input to COMPUTER.
[VIDEO]	Sets the input to VIDEO.
[DVI-I]	Sets the input to DVI-I.
[HDMI]	Sets the input to HDMI.
[DIGITAL LINK]	Sets the input to DIGITAL LINK.

**[DIGITAL LINK INPUT]**

Can only be selected when [STARTUP INPUT SELECT] is set to [DIGITAL LINK].

**1) Press ▲▼ to select [DIGITAL LINK INPUT].**

**2) Press ◀▶ to switch [DIGITAL LINK INPUT].**

- The items will switch each time you press the button.

[CURRENT]	Switches the input to DIGITAL LINK.
[INPUT1]	Switches to DIGITAL LINK input, and that input switches to the specified input when the Panasonic twisted-pair-cable transmitter is connected.
[INPUT2]	
[INPUT3]	
[INPUT4]	
[INPUT5]	
[INPUT6]	
[INPUT7]	
[INPUT8]	
[INPUT9]	
[INPUT10]	

**Note**

- When the Panasonic twisted-pair-cable transmitter (such as the optional digital interface box (Model No.: ET-YFB100G)) is connected to the projector, its input name is reflected from [INPUT1] to [INPUT10] automatically. If an item where the input name is not reflected is selected, it is disabled.

**[RS-232C]**

Set the sending and receiving port of the serial command.

**Communicating using the <SERIAL IN> terminal**

- 1) Press ▲▼ to select [RS-232C].
- 2) Press the <ENTER> button.
  - The [RS-232C] screen is displayed.
- 3) Press ▲▼ to select [INPUT SELECT].
- 4) Press ◀▶ to switch [SERIAL].
- 5) Press ▲▼ to select [BAUDRATE].
- 6) Press ◀▶ to switch [BAUDRATE].
  - The items will switch each time you press the button.

[9600]	Select the proper speed.
[19200]	
[38400]	

- 7) Press ▲▼ to select [PARITY].
- 8) Press ◀▶ to switch [PARITY].
  - The items will switch each time you press the button.

[NONE]	Select the parity condition.
[EVEN]	
[ODD]	

**Communicating using the <DIGITAL LINK/LAN> terminal**

- 1) Press ▲▼ to select [RS-232C].
- 2) Press the <ENTER> button.
  - The [RS-232C] screen is displayed.
- 3) Press ▲▼ to select [INPUT SELECT].
- 4) Press ◀▶ to switch [DIGITAL LINK].
- 5) Press ▲▼ to select [PARITY].

6) Press ◀▶ to switch [PARITY].

- The items will switch each time you press the button.

[NONE]	Select the parity condition.
[EVEN]	
[ODD]	

### When using existing projector control commands

Set each item when controlling the projector from a computer using control commands of a previously purchased Panasonic projector. Existing Panasonic projector control software and other software can still be used.

1) Press ▲▼ to select [RS-232C].

2) Press the <ENTER> button.

- The [RS-232C] screen is displayed.

3) Press ▲▼ to select [EMULATE].

4) Press the <ENTER> button.

5) Press ▲▼ to select an item.

[DEFAULT]	RZ470 series, RW430 series, RZ370 series, RW330 series
[D3500]	D3500 series
[D4000]	D4000 series
[D/W5k SERIES]	D5700 series, DW5100 series, D5600 series, DW5000 series, D5500 series
[D/W/26k SERIES]	DZ770 series, DW740 series, DX810 series, DW730 series, DX800 series, DZ6710 series, DZ6700 series, DW6300 series, D6000 series, D5000 series, DZ570 series, DW530 series, DX500 series
[L730 SERIES]	L730 series, L720 series, L520 series
[L780 SERIES]	L780 series, L750 series
[L735 SERIES]	L735 series
[L785 SERIES]	L785 series
[F/W SERIES]	FW430 series, FX400 series, FW300 series, F300 series, F200 series, FW100 series, F100 series
[LZ370]	LZ370 series
[LB/W SERIES]	LB3 series, LB2 series, LB1 series, ST10 series, LB90 series, LW80NT series, LB80 series, LB78 series, LB75 series
[VX500 SERIES]	VW435N series, VW430 series, VX505N series, VX500 series, VW330 series, VX400NT series, VX400 series, VX41 series
[EZ570 SERIES]	EZ570 series, EW630 series, EW530 series, EX600 series, EX500 series
[VW431D]	VW431D series

6) Press the <ENTER> button.

7) When the confirmation is displayed, select [OK] or [CANCEL], and press the <ENTER> button.

#### Note

- Refer to “<SERIAL IN> terminal” (➔ page 127).
- When [DIGITAL LINK] is selected, communication using that serial terminal is only available when the corresponding device (such as the optional digital interface box (Model No.: ET-YFB100G)) is connected to the <DIGITAL LINK/LAN> terminal.
- When transferring logos via the optional digital interface box (Model No.: ET-YFB100G), “NO SIGNAL SLEEP” of ET-YFB100G must be set to “OFF” to avoid cutting off communication.
- When [DIGITAL LINK] is selected, communication speed is fixed to 9 600 bps.

### [FUNCTION BUTTON]

Display the functions that are currently assigned to the <FUNC1> - <FUNC3> buttons on the remote control. Also, cancel the assigned settings.

#### Canceling the assigned settings of the <FUNC1> - <FUNC3> buttons

1) Press ▲▼ to select [FUNCTION BUTTON].

2) Press the <ENTER> button.

- The [FUNCTION BUTTON] screen is displayed.

- 3) Press ▲▼ to select the function button (F1 - F3) in which assignment will be canceled.
- 4) Press the <DEFAULT> button on the remote control.
- 5) When the confirmation is displayed, select [OK] and press the <ENTER> button.

**Note**

- You can also cancel the assigned settings by displaying the on-screen menu, selecting the menu item to be canceled (main menu, sub-menu, or details menu), and then pressing any one of the corresponding <FUNC1> - <FUNC3> buttons for at least three seconds.

**[AUDIO SETTING]**

Set advanced audio functions.

**Adjusting the volume**

- 1) Press ▲▼ to select [AUDIO SETTING].
- 2) Press the <ENTER> button.
  - The [AUDIO SETTING] screen is displayed.
- 3) Press ▲▼ to select [VOLUME].
- 4) Press ◀▶ to adjust the level.

Operation	Adjustment	Range of adjustment
Press the ▶ button.	Increases the volume.	0 - 63
Press the ◀ button.	Decreases the volume.	

**Adjusting the left/right audio balance**

- 1) Press ▲▼ to select [AUDIO SETTING].
- 2) Press the <ENTER> button.
  - The [AUDIO SETTING] screen is displayed.
- 3) Press ▲▼ to select [BALANCE].
- 4) Press ◀▶ to adjust the level.

Operation	Adjustment	Range of adjustment
Press the ▶ button.	Increases the volume on the right.	L16 - R16
Press the ◀ button.	Increases the volume on the left.	

**Setting the audio output during standby**

- 1) Press ▲▼ to select [AUDIO SETTING].
- 2) Press the <ENTER> button.
  - The [AUDIO SETTING] screen is displayed.
- 3) Press ▲▼ to select [IN STANDBY MODE].
- 4) Press ◀▶ to switch [IN STANDBY MODE].
  - The items will switch each time you press the button.

[OFF]	Turns off audio output during standby.
[ON]	Turns on audio output during standby.

**Note**

- When [STANDBY MODE] (▶ page 79) of [ECO MANAGEMENT] is set to [ECO], audio cannot be output during standby.
- The projector has no built-in speakers.  
Audio can be output via external audio systems connected to the audio output terminal.



### Setting audio input when HDMI input is selected

- 1) Press ▲▼ to select [AUDIO SETTING].
- 2) Press the <ENTER> button.
  - The [AUDIO SETTING] screen is displayed.
- 3) Press ▲▼ to select [HDMI].
- 4) Press ◀▶ to switch [HDMI].
  - The items will switch each time you press the button.

[HDMI AUDIO]	Outputs HDMI audio.
[AUDIO IN]	Outputs audio connected via the <AUDIO IN> terminal.

#### Note

- If COMPUTER, DVI-I, or VIDEO input is selected, audio connected to the <AUDIO IN> terminal is output.

### Setting audio input when DIGITAL LINK input is selected

- 1) Press ▲▼ to select [AUDIO SETTING].
- 2) Press the <ENTER> button.
  - The [AUDIO SETTING] screen is displayed.
- 3) Press ▲▼ to select [DIGITAL LINK].
- 4) Press ◀▶ to switch [DIGITAL LINK].
  - The items will switch each time you press the button.

[DIGITAL LINK AUDIO]	Outputs DIGITAL LINK audio.
[AUDIO IN]	Outputs audio connected via the <AUDIO IN> terminal.

#### Note

- If COMPUTER, DVI-I, or VIDEO input is selected, audio connected to the <AUDIO IN> terminal is output.

### [STATUS]

Display the status of the projector.

- 1) Press ▲▼ to select [STATUS].
- 2) Press the <ENTER> button.
  - The [STATUS] screen is displayed.
- 3) Press ◀▶ to switch the pages.
  - The page will change each time you press the button.

[INPUT]	Displays the input terminal currently selected.
[SIGNAL NAME]	Displays the input signal name.
[SIGNAL FREQUENCY]	Displays the frequency of the input signal.
[PROJECTOR RUNTIME]	Displays the operation times of the projector.
[INTAKE AIR TEMP.]	Displays the status of the air intake temperature of the projector.
[OPTICS MODULE TEMP.]	Displays the status of the internal temperature of the projector.
[NUMBER OF ENTRY SIGNAL]	Displays the number of registered signals.
[EMULATE]	Displays the [EMULATE] settings.
[PROJECTOR TYPE]	Displays the type of the projector.
[SERIAL NUMBER]	Displays the serial number of the projector.
[MAIN VERSION]	Displays the main version of the firmware of the projector.
[SUB VERSION]	Displays the sub version of the firmware of the projector.
[NETWORK VERSION]	Displays the network version of the projector.

**Note**

- The content of status can be sent via E-mail by pressing the <ENTER> button while displaying the status.

**[DATE AND TIME]**

Set the time zone, date, and time of the built-in clock of the projector.

**Setting the time zone**

- 1) Press ▲▼ to select [DATE AND TIME].
- 2) Press the <ENTER> button.
  - The [DATE AND TIME] screen is displayed.
- 3) Press ▲▼ to select [TIME ZONE].
- 4) Press ◀▶ to switch [TIME ZONE].

**Setting the date and time manually**

- 1) Press ▲▼ to select [DATE AND TIME].
- 2) Press the <ENTER> button.
  - The [DATE AND TIME] screen is displayed.
- 3) Press ▲▼ to select [ADJUST CLOCK].
- 4) Press the <ENTER> button.
  - The [ADJUST CLOCK] screen is displayed.
- 5) Press ▲▼ to select an item, and press ◀▶ to set the local date and time.
- 6) Press ▲▼ to select [APPLY], and press the <ENTER> button.
  - The setting of the time will be completed.

**Setting the date and time automatically**

- 1) Press ▲▼ to select [DATE AND TIME].
- 2) Press the <ENTER> button.
  - The [DATE AND TIME] screen is displayed.
- 3) Press ▲▼ to select [ADJUST CLOCK].
- 4) Press the <ENTER> button.
  - The [ADJUST CLOCK] screen is displayed.
- 5) Press ▲▼ to select [NTP SYNCHRONIZATION], and press ◀▶ to change the setting to [ON].
  - The items will switch each time you press the button.

[OFF]	Disables [NTP SYNCHRONIZATION].
[ON]	Enables [NTP SYNCHRONIZATION].

- 6) Press ▲▼ to select [APPLY], and press the <ENTER> button.
  - The setting of the time will be completed.

**Note**

- To set the date and time automatically, the projector must be connected to the network.
- If synchronization with the NTP server fails just after [NTP SYNCHRONIZATION] is turned [ON], or if [NTP SYNCHRONIZATION] is turned [ON] while the NTP server is not set, [NTP SYNCHRONIZATION] will return to [OFF].
- Access the projector via a web browser to set the NTP server. Refer to “[Adjust clock] page” (➔ page 108) for details.

**[SAVE ALL USER DATA]**

Save the various setting values as a backup in the built-in memory of the projector.

- 1) Press ▲▼ to select [SAVE ALL USER DATA].

- 2) **Press the <ENTER> button.**
  - The [SECURITY PASSWORD] screen is displayed.
- 3) **Enter a security password and press the <ENTER> button.**
- 4) **When the confirmation is displayed, select [OK] or [CANCEL], and press the <ENTER> button.**
  - [PROGRESS] is displayed while saving data.

**Note**

- The image setting registered in [USER LOGO] is not saved.

**[LOAD ALL USER DATA]**

Load the various setting values saved as a backup in the built-in memory of the projector.

- 1) **Press ▲▼ to select [LOAD ALL USER DATA].**
- 2) **Press the <ENTER> button.**
  - The [SECURITY PASSWORD] screen is displayed.
- 3) **Enter a security password and press the <ENTER> button.**
- 4) **When the confirmation is displayed, select [OK] or [CANCEL], and press the <ENTER> button.**

**Note**

- The projector will go into the standby status to reflect the setting values when [LOAD ALL USER DATA] is executed.

**[INITIALIZE]**

Return various setting values to their factory default settings.

- 1) **Press ▲▼ to select [INITIALIZE].**
- 2) **Press the <ENTER> button.**
  - The [SECURITY PASSWORD] screen is displayed.
- 3) **Enter a security password and press the <ENTER> button.**
  - The [INITIALIZE] screen is displayed.
- 4) **Press ▲▼ to select an item to initialize.**

[ALL USER DATA]	Returns all setting items including [ENTRY SIGNAL], [NETWORK SETUP], [E-mail set up], and [USER LOGO] to factory default settings. The projector will go into the standby status to reflect the setting values.
[ENTRY SIGNAL]	Deletes all the setting values saved for each input signal. To delete only a part of a registered signal, perform the procedure described in “Deleting the registered signal” (▶ page 94).
[NETWORK/E-MAIL]	Returns [NETWORK SETUP] and [E-mail set up] to factory default settings.
[LOGO IMAGE]	Deletes the image registered in [USER LOGO].

- 5) **Press the <ENTER> button.**
- 6) **When the confirmation is displayed, select [OK] or [CANCEL], and press the <ENTER> button.**

**[SERVICE PASSWORD]**

This function is used by a service person.

## [TEST PATTERN] menu

On the menu screen, select [TEST PATTERN] from the main menu.  
Refer to “Navigating through the menu” (➔ page 44) for the operation of the menu screen.

- Press ◀▶ to switch.

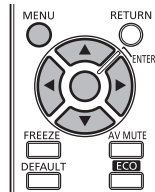

### [TEST PATTERN]

Display the test pattern built-in to the projector.

Settings of position, size, and other factors will not be reflected in test patterns. Make sure to display the input signal before performing various adjustments.

#### 1) Press ◀▶ to switch [TEST PATTERN].

- The items will switch each time you press the button.

Menu screen + All white	
Menu screen + All black	
Menu screen + Window	
Menu screen + Window (inversion)	
Menu screen + Color bar (vertical)	Displays test patterns with the menu screen. Select a test pattern so that it is easy to make various adjustments.
Menu screen + Color bar (horizontal)	
Menu screen + 16:9/4:3 aspect frame	
Menu screen + Focus	
Menu screen + Entry screen	Displays the menu screen and input signal. Built-in test patterns are not displayed.

#### Note

- Press the <MENU> button while the test pattern is displayed to hide the on-screen menu.
- If the on-screen display is hidden while displaying the test pattern, the test pattern is not switched even if ◀▶ are pressed. To switch the test pattern, operate with the on-screen displayed.

## [SIGNAL LIST] menu

On the menu screen, select [SIGNAL LIST] from the main menu.  
Refer to “Navigating through the menu” (➔ page 44) for the operation of the menu screen.

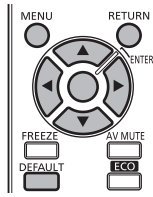

### ■ Registered signal details

- A name can be set for each sub memory (➔ page 74).
- Memory number:

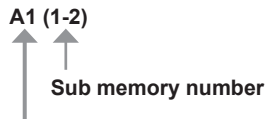

When the signal of the address number (A1, A2, ...L7, L8) is registered.

## Registering new signals

After a new signal is input and the <MENU> button on the remote control or the control panel is pressed, the registration is completed and the [MAIN MENU] screen is displayed.

### Note

- Up to 96 signals, including sub memories, can be registered to the projector.
- There are 12 pages (eight memories of A through L, with eight memories possible on each page) for memory numbers, and the signal is registered to the lowest number that is available. If there is no available memory number it will be overwritten from the oldest signal.
- The names to be registered are automatically determined by the input signals and memory numbers.
- If a menu is being displayed, the new signals will be registered at the instant they are input.

## Renaming the registered signal

Registered signals can be renamed.

- 1) Press ▲▼◀▶ to select the signal for which details are to be displayed.
- 2) Press the <ENTER> button.
  - The [REGISTERED SIGNAL STATUS] screen is displayed.
  - The input signal name, memory number, input terminal, frequency, synchronization signal, etc., are displayed.
  - Press the <RETURN> button or the <MENU> button to return to the [REGISTERED SIGNAL LIST] screen.
- 3) Press the <ENTER> button.
  - The [RENAME] screen is displayed.
- 4) Press ▲▼◀▶ to select the text, and press the <ENTER> button to enter the text.
- 5) After the name is changed, press ▲▼◀▶ to select [OK], and press the <ENTER> button.
  - The registration is completed and the [REGISTERED SIGNAL STATUS] screen returns.
  - When pressing ▲▼◀▶ to select [CANCEL] and pressing the <ENTER> button, the changed signal name will not be registered and an automatically registered signal name will be used.

## Deleting the registered signal

---

Registered signals can be deleted.

- 1) **Press ▲▼◀▶ to select the signal to delete.**
- 2) **Press the <DEFAULT> button.**
  - The [ENTRY SIGNAL DELETE] screen is displayed.
  - To cancel deletion, press the <RETURN> button or the <MENU> button to return to the [REGISTERED SIGNAL LIST] screen.
- 3) **Press the <ENTER> button.**
  - The selected signal will be deleted.

## [SECURITY] menu

On the menu screen, select [SECURITY] from the main menu, and select the item from the sub-menu.

Refer to “Navigating through the menu” (➔ page 44) for the operation of the menu screen.

- When the projector is used for the first time  
Initial password: Press ▲▶▼◀▶▶▼◀ in order, and press the <ENTER> button.
- After selecting the item, press ▲▼◀▶ to set.

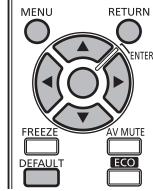

### Attention

- When you select the [SECURITY] menu and press the <ENTER> button, entering a password is required. Enter the preset password and then continue operations of the [SECURITY] menu.
- When the password has been changed previously, enter the changed password, and press the <ENTER> button.

### Note

- The entered password is displayed with \* mark on the screen.
- An error message is displayed on the screen when the entered password is incorrect. Re-enter the correct password.

## [SECURITY PASSWORD]

The [SECURITY PASSWORD] screen is displayed when the power is turned on. If an incorrect password has been entered, operations other than the power <⏻/|> button and the <AV MUTE> button are not available.

- 1) Press ▲▼ to select [SECURITY PASSWORD].
- 2) Press ◀▶ to switch [SECURITY PASSWORD].
  - The items will switch each time you press the button.

[OFF]	Disables the security password entry.
[ON]	Enables the security password entry.

### Note

- [SECURITY PASSWORD] is set to [OFF] at the time of purchase or when [ALL USER DATA] has been initialized.
- Change the password periodically that is hard to guess.
- The security password is enabled after setting [SECURITY PASSWORD] to [ON] and turning the <MAIN POWER> switch to <OFF>.

## [SECURITY PASSWORD CHANGE]

Change the security password.

- 1) Press ▲▼ to select [SECURITY PASSWORD CHANGE].
- 2) Press the <ENTER> button.
  - The [SECURITY PASSWORD CHANGE] screen is displayed.
- 3) Press ▲▼◀▶ and the number (<1> - <6>) buttons to set the password.
  - Up to eight button operations can be set.
- 4) Press the <ENTER> button.
- 5) Re-enter the password for the confirmation.
- 6) Press the <ENTER> button.

### Note

- The entered password is displayed with \* mark on the screen.
- If numbers have been used for the security password, the security password will need to be initialized again if the remote control is lost. Consult your dealer for the initialization method.

**[TEXT DISPLAY]**

Overlap the security message (text) over the projected image.

- 1) Press ▲▼ to select [TEXT DISPLAY].
- 2) Press ◀▶ to switch [TEXT DISPLAY].
  - The items will switch each time you press the button.

[OFF]	Hides the security message.
[ON]	Displays the security message.

**Note**

- If a closed caption signal of the selected mode is input, the security message is not displayed.

**[TEXT CHANGE]**

Change the text displayed when [TEXT DISPLAY] is set to [ON].

- 1) Press ▲▼ to select [TEXT CHANGE].
- 2) Press the <ENTER> button.
  - The [TEXT CHANGE] screen is displayed.
- 3) Press ▲▼◀▶ to select the text, and press the <ENTER> button to enter the text.
  - Up to 22 characters can be input.
- 4) Press ▲▼◀▶ to select [OK], and press the <ENTER> button.
  - The text is changed.

**[MENU LOCK]**

Display the menu with the <MENU> button, and set whether to enable menu operations.

- 1) Press ▲▼ to select [MENU LOCK].
- 2) Press ◀▶ to switch [MENU LOCK].
  - The items will switch each time you press the button.

[OFF]	Cancels the lock on menu operations.
[ON]	Locks menu operations.

**Note**

- After setting [MENU LOCK] to [ON], the <MENU> button cannot be operated if the incorrect password is input.
- [MENU LOCK] is set to [OFF] at the time of purchase or when [ALL USER DATA] has been initialized.
- The lock release is maintained until the projector enters standby.

**[MENU LOCK PASSWORD]**

Change the menu lock password.

- 1) Press ▲▼ to select [MENU LOCK PASSWORD].
- 2) Press the <ENTER> button.
  - The [MENU LOCK PASSWORD] screen is displayed.
- 3) Press ▲▼◀▶ to select the text, and press the <ENTER> button to enter the text.
  - Up to 16 characters can be input.
- 4) Press ▲▼◀▶ to select [OK], and press the <ENTER> button.
  - To cancel, select [CANCEL].

**Attention**

- The initial password is "AAAA" at the time of purchase or when [ALL USER DATA] has been initialized.
- Change the password periodically that is hard to guess.



**[CONTROL DEVICE SETUP]**

Enable/disable the button operations on the control panel and the remote control.

- 1) Press ▲▼ to select **[CONTROL DEVICE SETUP]**.
- 2) Press the <ENTER> button.
  - The **[CONTROL DEVICE SETUP]** screen is displayed.
- 3) Press ▲▼ to select **[CONTROL PANEL]** or **[REMOTE CONTROL]**.
- 4) Press the <ENTER> button.
  - The **[CONTROL PANEL]** screen or the **[REMOTE CONTROL]** screen is displayed.
- 5) Press ▲▼ to select **[ENABLE]** or **[DISABLE]**.
  - You can set the operation restriction from the control panel or the remote control.

<b>[ENABLE]</b>	Enables all button operations on the projector body or the remote control.
<b>[DISABLE]</b>	Disables all button operations on the projector body or the remote control.

- 6) Press the <ENTER> button.
- 7) When the confirmation is displayed, select **[OK]** or **[CANCEL]**, and press the <ENTER> button.

**Note**

- When a button operation is performed on the device set to **[DISABLE]**, the **[SECURITY PASSWORD]** screen is displayed. To continue operations, enter the security password.
- The **[SECURITY PASSWORD]** screen will disappear when the <MENU> button is pressed, or when there is no operation for approximately ten seconds.
- If the operations of both **[CONTROL PANEL]** and **[REMOTE CONTROL]** are set to **[DISABLE]**, the projector cannot be turned off (cannot enter standby).
- When the setting has completed, the menu screen will disappear. To operate continuously, press the <MENU> button to display the main menu.

## [NETWORK] menu

On the menu screen, select [NETWORK] from the main menu, and select the item from the sub-menu.

Refer to “Navigating through the menu” (→ page 44) for the operation of the menu screen.

- After selecting the item, press ▲▼◀▶ to set.

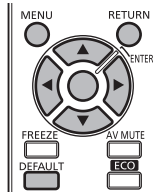

### [DIGITAL LINK MODE]

Switch the communication method of the <DIGITAL LINK/LAN> terminal of the projector.

- 1) Press ▲▼ to select [DIGITAL LINK MODE].
- 2) Press ◀▶ to switch [DIGITAL LINK MODE].
  - The items will switch each time you press the button.

[AUTO]	Switches the communication method automatically to DIGITAL LINK or Ethernet.
[DIGITAL LINK]	Fixes the communication method to DIGITAL LINK.
[ETHERNET]	Fixes the communication method to Ethernet.

### Possible communication modes

Setting		Communication possible		
		HDMI	Ethernet	RS-232C
[AUTO]	For DIGITAL LINK	✓	✓	✓
	For Ethernet	—	✓	—
[DIGITAL LINK]		✓	✓	✓
[ETHERNET]		—	✓	—

✓: Communication possible

—: Communication not possible

### [DIGITAL LINK SETUP]

Set the communication method of DIGITAL LINK.

#### When the projector is connected directly via Ethernet

- 1) Press ▲▼ to select [DIGITAL LINK SETUP].
- 2) Press the <ENTER> button.
  - The [DIGITAL LINK SETUP] screen is displayed.
- 3) Press ▲▼ to select [DUPLX(ETHERNET)].
- 4) Press ◀▶ to switch the communication method.
  - The items will switch each time you press the button.

[AUTONEGOTIATION]	The communication method is set automatically.
[100BaseTX-Full]	Full-duplex communication method is set.
[100BaseTX-Half]	Half-duplex communication method is set.

- 5) Press ▲▼ to select [STORE].
- 6) Press the <ENTER> button.
- 7) When the confirmation is displayed, select [OK] or [CANCEL], and press the <ENTER> button.

**Note**

- The projector does not support 10BaseT Full/Half.

**When the projector is connected to a twisted-pair-cable transmitter**

- 1) Press ▲▼ to select [DIGITAL LINK SETUP].
- 2) Press the <ENTER> button.
  - The [DIGITAL LINK SETUP] screen is displayed.
- 3) Press ▲▼ to select [DUPLEX(DIGITAL LINK)].
- 4) Press ◀▶ to switch the communication method.
  - The items will switch each time you press the button.

[100BaseTX-Full]	Full duplex communication method is set.
[100BaseTX-Half]	Half-duplex communication method is set.
[AUTONEGOTIATION]	The communication method is set automatically.

- 5) Press ▲▼ to select [STORE].
- 6) Press the <ENTER> button.
- 7) When the confirmation is displayed, select [OK] or [CANCEL], and press the <ENTER> button.

**[DIGITAL LINK STATUS]**

Display DIGITAL LINK connection environment.

- 1) Press ▲▼ to select [DIGITAL LINK STATUS].
- 2) Press the <ENTER> button.
  - The [DIGITAL LINK STATUS] screen is displayed.

[LINK STATUS]	Either [NO LINK], [DIGITAL LINK], or [ETHERNET] is displayed.
[HDMI STATUS]	Either [NO HDMI], [HDMI ON], or [HDCP ON] is displayed.
[SIGNAL QUALITY]	<p>[SIGNAL QUALITY] is a numerical value of the amount of error, and the display color changes to green, yellow, or red depending on that value. Check the signal quality level while receiving a signal from the twisted-pair-cable transmitter.</p> <ul style="list-style-type: none"> <li>• MAX/MIN: Maximum/minimum value of the amount of error.</li> <li>• Green (–12 dB or lower) → Normal signal quality level.</li> <li>• Yellow (–11 to –8 dB) → Warning level where there is the possibility of noise introduced on the screen.</li> <li>• Red (–7 dB or higher) → Abnormal level where synchronization may be interrupted, or a signal may not be received.</li> </ul>

**[NETWORK SETUP]**

Perform the initial setting of the network before using the network function.

- 1) Press ▲▼ to select [NETWORK SETUP].
- 2) Press the <ENTER> button.
  - The [NETWORK SETUP] screen is displayed.
- 3) Press ▲▼ to select an item, and change the settings according to the operation instructions of the menu.

[PROJECTOR NAME]	Change the setting when using a DHCP server.
[DHCP]	Set to [ON] when obtaining an IP address automatically using a DHCP server. Set to [OFF] when not using a DHCP server.
[IP ADDRESS]	Enter the IP address when not using a DHCP server.
[SUBNET MASK]	Enter the subnet mask when not using a DHCP server.
[DEFAULT GATEWAY]	Enter the default gateway address when not using a DHCP server.

- 4) Press ▲▼ to select [STORE], and press the <ENTER> button.

5) When the confirmation is displayed, select [OK] or [CANCEL], and press the <ENTER> button.

**Note**

- When using a DHCP server, confirm that the DHCP server is running.
- Consult your network administrator regarding the IP address, subnet mask, and default gateway.

**[NETWORK CONTROL]**

Set up the control method of the network.

- 1) Press ▲▼ to select [NETWORK CONTROL].
- 2) Press the <ENTER> button.
  - The [NETWORK CONTROL] screen is displayed.
- 3) Press ▲▼ to select an item, and press ◀▶ to change the setting.

[WEB CONTROL]	Set to [ON] to control with the web browser.
[PJLink CONTROL]	Set to [ON] to control with the PJLink protocol.
[COMMAND CONTROL]	Set to [ON] when controlling the projector with the control command format (➡ page 129) of the <SERIAL IN> terminal. Refer to “Control commands via LAN” (➡ page 125).
[COMMAND PORT]	Set the port number used for command control.
[CRESTRON RoomView]	Set to [ON] to control with RoomView of Crestron Electronics, Inc.
[AMX D.D.]	Set to [ON] to control with the controller of AMX Corporation. Setting this function to [ON] enables detection through “AMX Device Discovery”. For details, refer to the website of AMX Corporation. URL <a href="http://www.amx.com/">http://www.amx.com/</a>
[EXTRON XTP]	Set to [ON] when connecting the “XTP transmitter” of Extron Electronics to the <DIGITAL LINK/LAN> terminal. [EXTRON XTP] must be set to [OFF] when connecting the optional digital interface box (Model No.: ET-YFB100G). For details of the “XTP transmitter”, refer to the website of Extron Electronics. URL <a href="http://www.extron.com/">http://www.extron.com/</a>
[STORE]	Save the current network control settings.

- 4) Press ▲▼ to select [STORE], and press the <ENTER> button.
- 5) When the confirmation is displayed, select [OK] or [CANCEL], and press the <ENTER> button.

**[NETWORK STATUS]**

Display the status of the projector network.

- 1) Press ▲▼ to select [NETWORK STATUS].
- 2) Press the <ENTER> button.
  - The [NETWORK STATUS] screen is displayed.

**Network connections**

The projector has a network function, and the following operations are available from the computer using the web control.

- Setting and adjustment of the projector
- Display of the projector status
- Sending of E-mail messages when there is a problem with the projector

The projector supports “Crestron RoomView”, and the following application software of Crestron Electronics, Inc. can be used.

- RoomView Express
- Fusion RV
- RoomView Server Edition

**Attention**

- Connect the LAN to indoor devices.

**Note**

- “Crestron RoomView” is a system of Crestron Electronics, Inc. that collectively manages and controls devices on multiple systems connected to a network using a computer.
- For details of “Crestron RoomView”, refer to the website of Crestron Electronics, Inc. (English only)  
URL <http://www.crestron.com>  
To download “RoomView Express”, go to the website of Crestron Electronics, Inc. (English only)  
URL <http://www.crestron.com/getroomview>
- A LAN cable is required to use the network function.

■ **Example of a normal network connection**

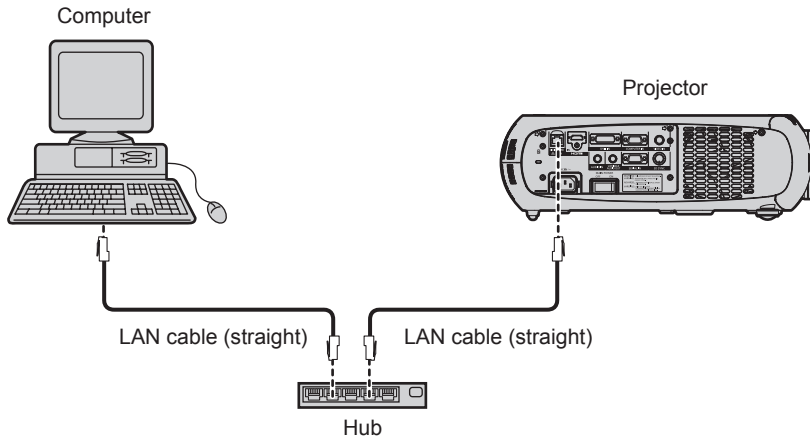

- A web browser is required to use this function. Confirm that the web browser can be used beforehand.  
Compatible OS: Windows XP/Windows Vista/Windows 7, Mac OS X v10.4/v10.5/v10.6/v10.7/v10.8  
Compatible browser: Internet Explorer 7.0/8.0/9.0, Safari 4.0/5.0/6.0 (Mac OS)
- Communication with an E-mail server is required to use the E-mail function. Confirm that the E-mail can be used beforehand.
- Use a LAN cable that is compatible with category 5 or higher.
- Use a LAN cable of 100 m (328'1") or shorter.

**Connecting to a twisted-pair-cable transmitter**

The projector has a function that can receive Ethernet signals from a twisted-pair-cable transmitter together with video and audio signals via a LAN cable.

Connect a LAN cable to the <DIGITAL LINK/LAN> terminal of the projector. (➔ pages 18, 23)

■ **Example of network connections via a twisted-pair-cable transmitter**

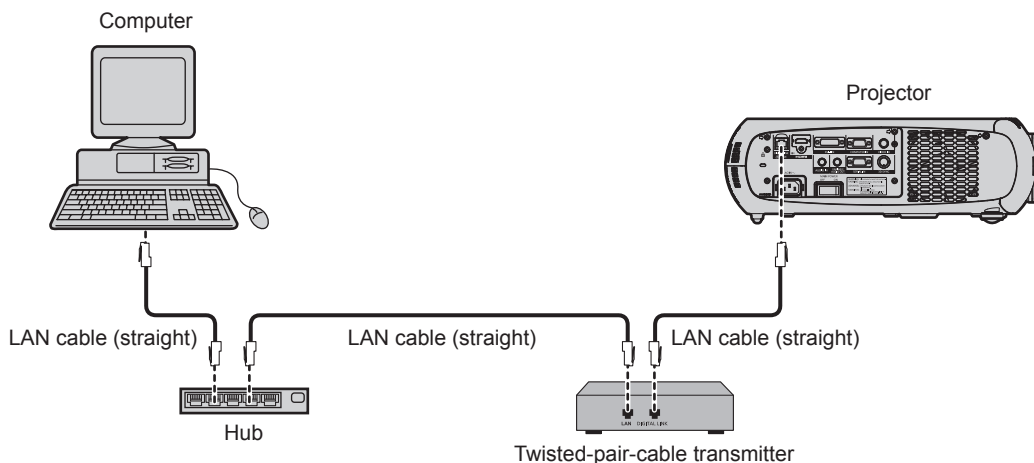

- For the LAN cable between a twisted-pair-cable transmitter and the projector, use a cable that meets the following criteria:
  - Compatible with CAT5e or higher
  - Shielded type (including connectors)
  - Straight-through
  - Single wire
- The maximum transmission distance between the twisted-pair-cable transmitter and the projector is 100 m (328'1"). If this distance is exceeded, image and sound may be disrupted and may cause a malfunction in LAN communication.
- When laying cables, check that cable characteristics are compatible with CAT5e or higher using tools such as a cable tester or cable analyzer.  
When using a relay connector midway, include it in the measurement.
- Do not use a hub between a twisted-pair-cable transmitter and the projector.
- Do not pull cables forcefully. Also, do not bend or fold cables unnecessarily.
- To reduce the effects of noise as much as possible, stretch out the cables between the twisted-pair-cable transmitter and the projector without any loops.
- Lay the cables between a twisted-pair-cable transmitter and the projector away from other cables, particularly power cables.
- When installing multiple cables, run them side by side along the shortest distance possible without bundling them together.
- After laying the cables, confirm that the value of [SIGNAL QUALITY] in the [NETWORK] menu → [DIGITAL LINK STATUS] is displayed in green (indicates normal quality). (➔ page 99)
- For twisted-pair-cable transmitter of other manufacturers of which the operation has been verified with the DIGITAL LINK compatible projector, refer to Panasonic website (<http://panasonic.net/avc/projector/>). Note that the verification for devices of other manufacturers has been made for the items set by Panasonic Corporation, and not all the operations have been verified. For operation or performance problems caused by the devices of other manufacturers, contact the respective manufacturers.

## Accessing from the web browser

- 1) Start up the web browser on the computer.
- 2) Enter the IP address set on the projector into the URL entry field of the web browser.
- 3) Enter the user name and the password.
  - The factory default setting of the user name is user1 (user rights)/admin1 (administrator rights) and the password is panasonic (lower case).



- 4) Click OK.
  - The [Projector status] page is displayed.

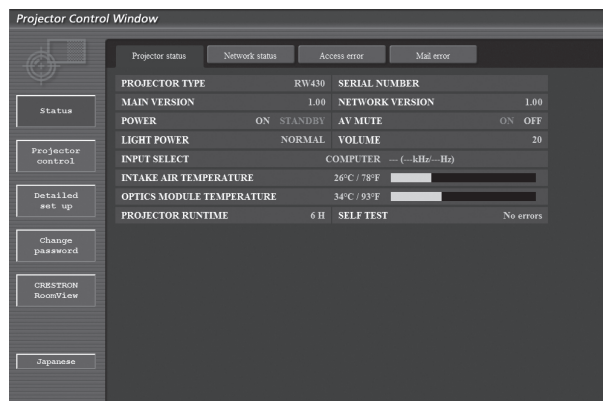

### Note

- If you use a web browser to control the projector, set [WEB CONTROL] to [ON] in [NETWORK CONTROL] (➔ page 100).

- Do not perform setting or control simultaneously by starting up multiple web browsers. Do not set or control the projector from multiple computers.
- Change the password first. (➔ page 113)
- The administrator rights allows to use all functions. The user rights only allows use of [Projector status] (➔ page 103), confirmation of the error information page (➔ page 104), [Network status] (➔ page 105), [Basic control] (➔ page 106), [Advanced control] (➔ page 106), [Change password] (➔ page 113).
- Access will be locked for few minutes when an incorrect password is entered three times consecutively.
- Some items on the projector setting page use the Javascript function of the web browser. The projector may not be able to be controlled properly if it is set with a browser that does not have this function enabled.
- While updating the screen for the web control, the screen may become white for a moment, but it is not a malfunction.

### Descriptions of items

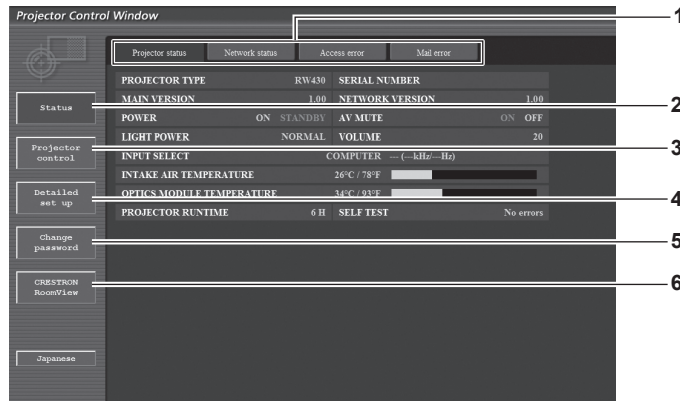

- |  |  |
|--|--|
| <p><b>1 Page tab</b><br/>Switches pages by clicking this item.</p> <p><b>2 [Status]</b><br/>The status of the projector is displayed by clicking this item.</p> <p><b>3 [Projector control]</b><br/>The [Projector control] page is displayed by clicking this item.</p> | <p><b>4 [Detailed set up]</b><br/>The [Detailed set up] page is displayed by clicking this item.</p> <p><b>5 [Change password]</b><br/>The [Change password] page is displayed by clicking this item.</p> <p><b>6 [CRESTRON RoomView]</b><br/>The control page of RoomView is displayed by clicking this item.</p> |
|--|--|

### [Projector status] page

Click [Status] → [Projector status].  
Display the status of the projector for the following items.

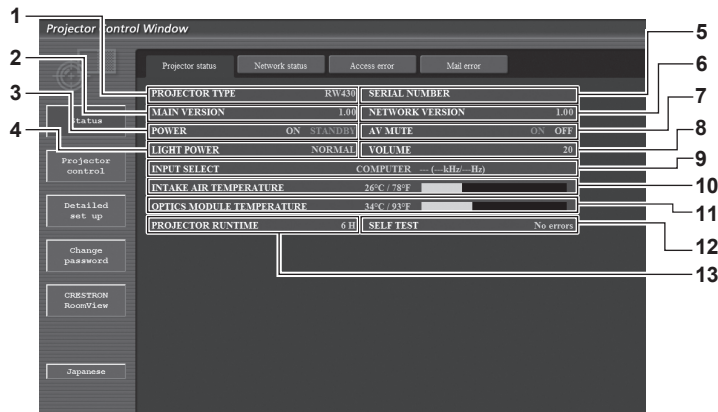

- |  |  |
|--|--|
| <p><b>1 [PROJECTOR TYPE]</b><br/>Displays the type of the projector.</p> <p><b>2 [MAIN VERSION]</b><br/>Displays the firmware version of the projector.</p> <p><b>3 [POWER]</b><br/>Displays the status of the power.</p> <p><b>4 [LIGHT POWER]</b><br/>Displays the setting status of [LIGHT POWER] (➔ page 77).</p> <p><b>5 [SERIAL NUMBER]</b><br/>Displays the serial number of the projector.</p> <p><b>6 [NETWORK VERSION]</b><br/>Displays the version of the firmware of the network.</p> <p><b>7 [AV MUTE]</b><br/>Displays the AV mute status.</p> | <p><b>8 [VOLUME]</b><br/>Displays the volume status.</p> <p><b>9 [INPUT SELECT]</b><br/>Displays the status of the input selection.</p> <p><b>10 [INTAKE AIR TEMPERATURE]</b><br/>Displays the status of the air intake temperature of the projector.</p> <p><b>11 [OPTICS MODULE TEMPERATURE]</b><br/>Displays the status of the internal temperature of the projector.</p> <p><b>12 [SELF TEST]</b><br/>Displays the self-diagnosis information.</p> <p><b>13 [PROJECTOR RUNTIME]</b><br/>Displays the runtime of the projector.</p> |
|--|--|

**Error information page**

When [Error (Detail)] appears in the self-diagnosis display of the [Projector status] screen, click it to display the error details.

- The projector may go into the standby status to protect the projector depending on the contents of the error.

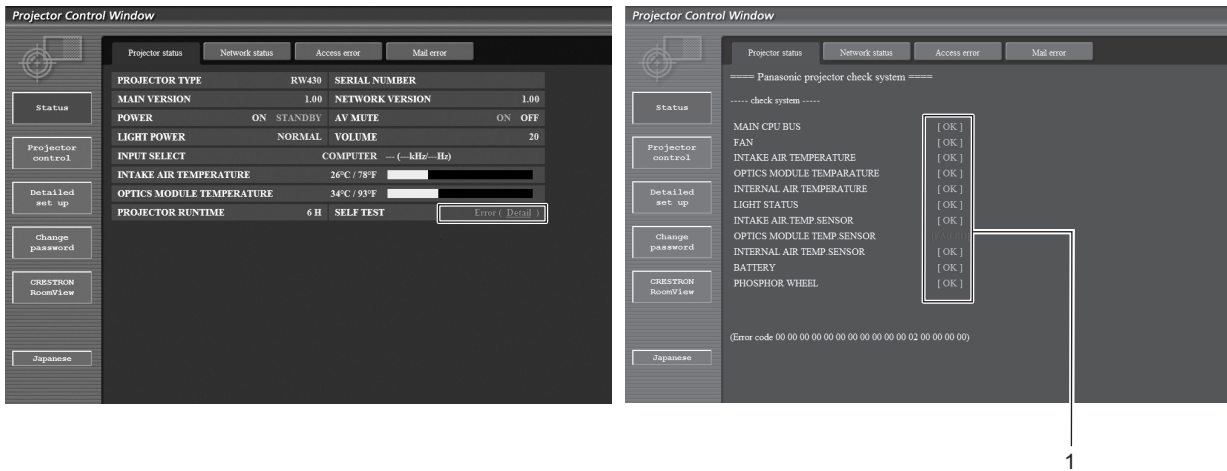

**1 Self-diagnosis result display**

Displays the item check results.

**[OK]:**

Indicates that operation is normal.

**[FAILED]:**

Indicates that there is a problem.

**[WARNING]:**

Indicates that there is a warning.

**■ Problem occurrence [FAILED] items**

Parameter	Description
[MAIN CPU BUS]	There is a problem with the microcomputer circuitry. Consult your dealer.
[FAN]	There is a problem with the fan or the fan drive circuit. Consult your dealer.
[INTAKE AIR TEMPERATURE]	The air intake temperature is too high. The projector may be used in an operating environment where the temperature is high, such as near a heating appliance.
[OPTICS MODULE TEMPERATURE]	The temperature around the optics module inside the projector is high. The projector may be used in an operating environment where the temperature is high, such as near a heating appliance.
[INTERNAL AIR TEMPERATURE]	The temperature inside the projector is high. The projector may be used in an operating environment where the temperature is high, such as near a heating appliance.
[LIGHT STATUS]	The light source failed to turn on or off. Wait a while until the light source cools off, and then turn on the power.
[INTAKE AIR TEMP.SENSOR]	There is a problem with the intake temperature detection sensor. Consult your dealer.
[OPTICS MODULE TEMP.SENSOR]	There is a problem with the temperature detection sensor around the optics module inside the projector. Consult your dealer.
[INTERNAL AIR TEMP.SENSOR]	There is a problem with the sensor used to detect temperature inside the projector. Consult your dealer.
[BATTERY]	Replacement of built-in battery is required. Consult your dealer.
[PHOSPHOR WHEEL]	There is a problem with the fluorescent wheel or fluorescent wheel drive circuit. Consult your dealer.



## [Network status] page

Click [Status] → [Network status].

The current network setting status is displayed.

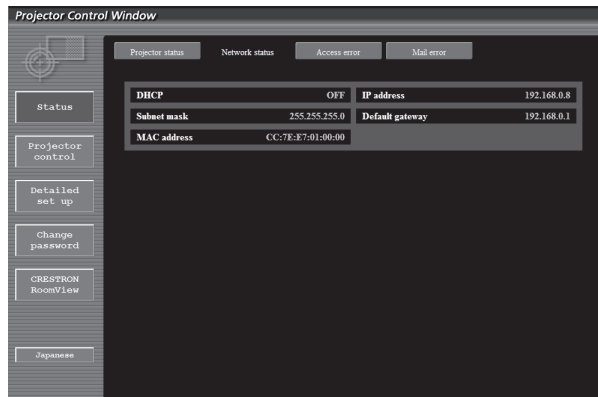

## [Access error] page

Click [Status] → [Access error].

The error log on the web server is displayed such as access to the pages that do not exist or access with unauthorized user names or passwords.

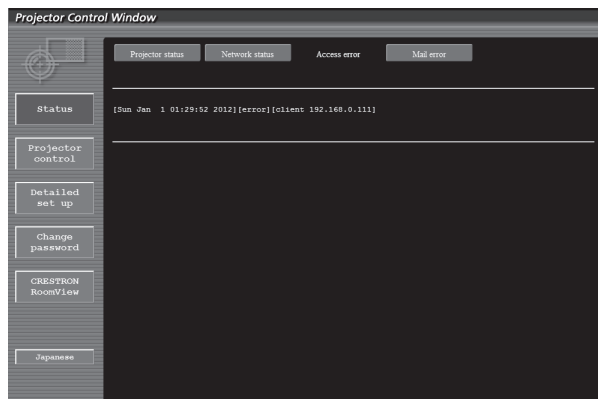

## [Mail error] page

Click [Status] → [Mail error].

Display E-mail error information if failed to send periodic E-mails.

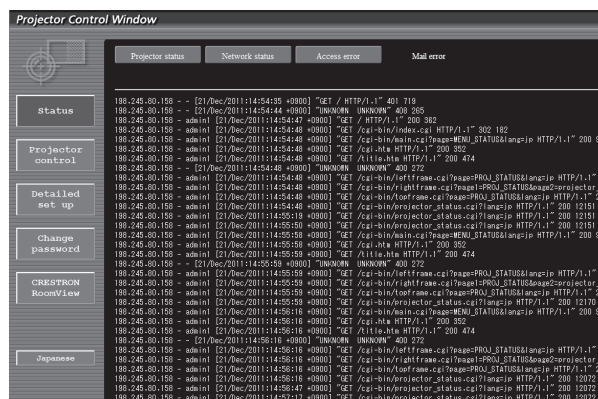

## Note

- [Access error]/[Mail error] displays the recent few hundred accesses/requests. All information may not be displayed when many accesses/requests are made at one time.
- When [Access error]/[Mail error] exceeds a certain amount, old information will be erased.
- Check [Access error]/[Mail error] periodically.

**[Basic control] page**

Click [Projector control] → [Basic control].

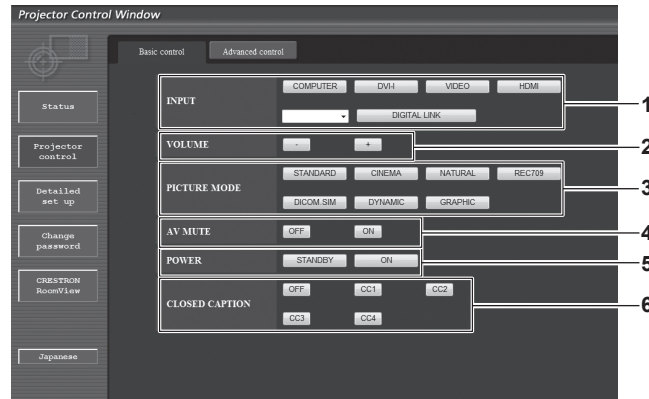

- |   |   |
|---|---|
| <p>1 <b>[INPUT]</b><br/>Switches the input signal.</p> <p>2 <b>[VOLUME]</b><br/>Adjusts the volume.</p> <p>3 <b>[PICTURE MODE]</b><br/>Switches the video mode.</p> | <p>4 <b>[AV MUTE]</b><br/>Switches between AV mute on/off.</p> <p>5 <b>[POWER]</b><br/>Switches on/off the power.</p> <p>6 <b>[CLOSED CAPTION]</b><br/>Switches the closed caption setting.</p> |
|---|---|

**[Advanced control] page**

Click [Projector control] → [Advanced control].

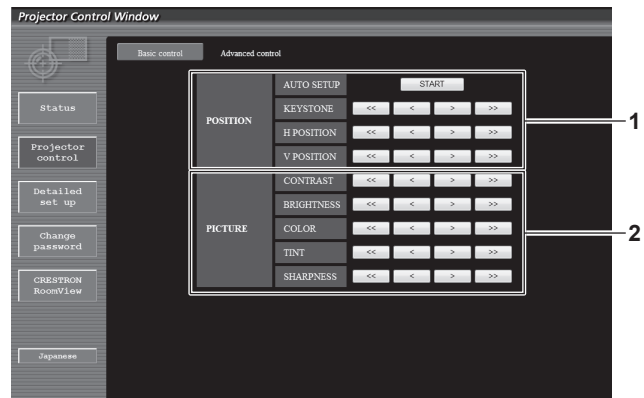

- |   |  |
|---|--|
| <p>1 <b>[POSITION]</b><br/>Operates items related to angle of view.</p> | <p>2 <b>[PICTURE]</b><br/>Operates items related to image quality.</p> |
|---|--|

**[Network config] page**

Click [Detailed set up] → [Network config].

- Click [Network config] to display the **[CAUTION!]** screen.
- The current settings are displayed by pressing the [Next] button.
- The following setting change screen is displayed by clicking the [Change] button.

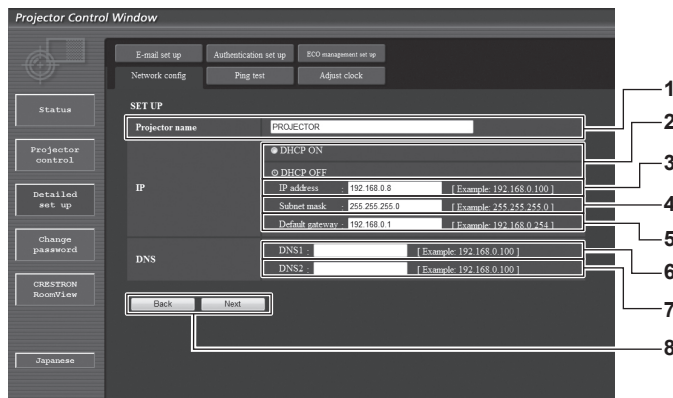

- [Projector name]**  
Enter the name of the projector. Enter the host name if it is required when using a DHCP server etc.
- [DHCP ON]/[DHCP OFF]**  
To enable the DHCP client function, set to [DHCP ON].
- [IP address]**  
Enter the IP address when not using a DHCP server.
- [Subnet mask]**  
Enter the subnet mask when not using a DHCP server.
- [Default gateway]**  
Enter the default gateway address when not using a DHCP server.
- [DNS1]**  
Enter the DNS1 server address.  
Permissible characters for the entry of DNS1 server address (primary):  
Numbers (0 - 9), period (.)  
(Example: 192.168.0.253)
- [DNS2]**  
Enter the DNS2 server address.  
Available characters for the entry of DNS2 server address (secondary):  
Numbers (0 - 9), period (.)  
(Example: 192.168.0.254)
- [Back]/[Next]**  
Click the [Back] button to return to the original screen. The current settings are displayed by pressing the [Next] button. Click the [Submit] button to update the settings.

**Note**

- When you use the “Forward” and “Back” functions of your browser, a warning message “Page has Expired” may appear. In that case, click [Network config] again since the following operation will not be guaranteed.
- Changing LAN settings while connected to the LAN may cause the connection to cut out.

**[Ping test] page**

Check whether the network is connected to the mail server, POP server, DNS server, etc.  
Click [Detailed set up] → [Ping test].

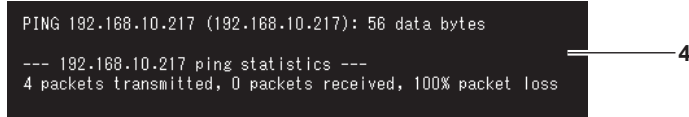
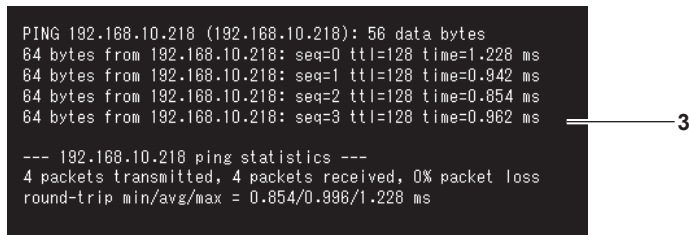
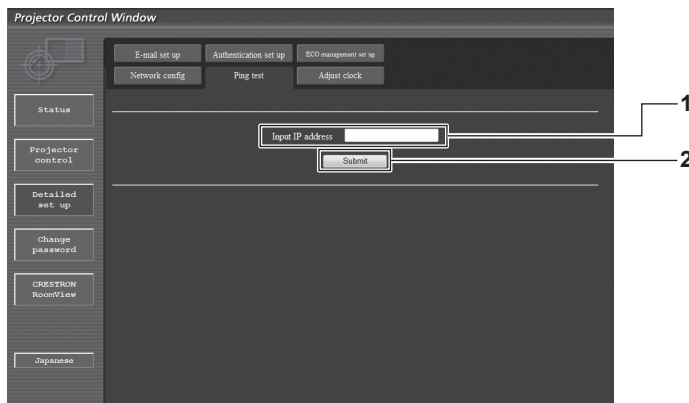

- |  |  |
|--|--|
| <p><b>1 [Input IP address]</b><br/>Enter the IP address of the server to be tested.</p> <p><b>2 [Submit]</b><br/>Executes the connection test.</p> | <p><b>3 Example of display when the connection has succeeded</b></p> <p><b>4 Example of display when the connection has failed</b></p> |
|--|--|

**[Adjust clock] page**

Click [Detailed set up] → [Adjust clock].

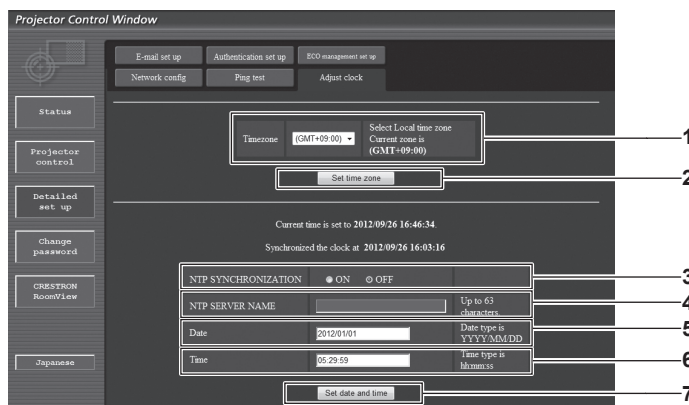

- |  |   |
|--|---|
| <p><b>1 [Timezone]</b><br/>Select the time zone.</p> <p><b>2 [Set time zone]</b><br/>Updates the time zone setting.</p> <p><b>3 [NTP SYNCHRONIZATION]</b><br/>Set to [ON] to adjust the date and time automatically.</p> <p><b>4 [NTP SERVER NAME]</b><br/>Enter the IP address or server name of the NTP server when you set to adjust the date and time manually.<br/>(To enter the server name, the DNS server needs to be set up.)</p> | <p><b>5 [Date]</b><br/>Enter the date to be changed.</p> <p><b>6 [Time]</b><br/>Enter the time to be changed.</p> <p><b>7 [Set date and time]</b><br/>Updates the date and time settings.</p> |
|--|---|

**Note**

- The replacement of the battery inside the projector is required when the time goes out of alignment right after correcting the time. Consult your dealer.

[E-mail set up] page

When there is a problem, an E-mail can be sent to preset E-mail addresses (up to two addresses).  
Click [Detailed set up] → [E-mail set up].

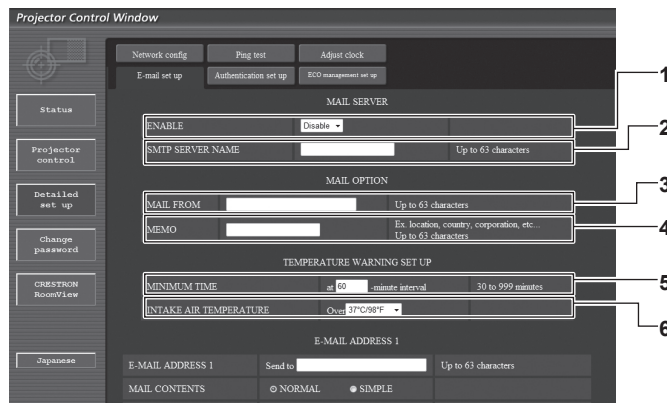

- 1 **[ENABLE]**  
Select [Enable] to use the E-mail function.
- 2 **[SMTP SERVER NAME]**  
Enter the IP address or the server name of the E-mail server (SMTP). To enter the server name, the DNS server needs to be set up.
- 3 **[MAIL FROM]**  
Enter the E-mail address of the projector. (Up to 63 characters in single byte)
- 4 **[MEMO]**  
Enter information such as the location of the projector that notifies the sender of the E-mail. (Up to 63 characters in single byte)

- 5 **[MINIMUM TIME]**  
Change the minimum interval for the temperature warning E-mail. The default value is 60 minutes. In this case, another E-mail will not be sent for 60 minutes after sending the temperature warning E-mail even if it reaches the warning temperature.
- 6 **[INTAKE AIR TEMPERATURE]**  
Change the temperature setting for the temperature warning mail. A temperature warning E-mail is sent when the temperature exceeds this value.

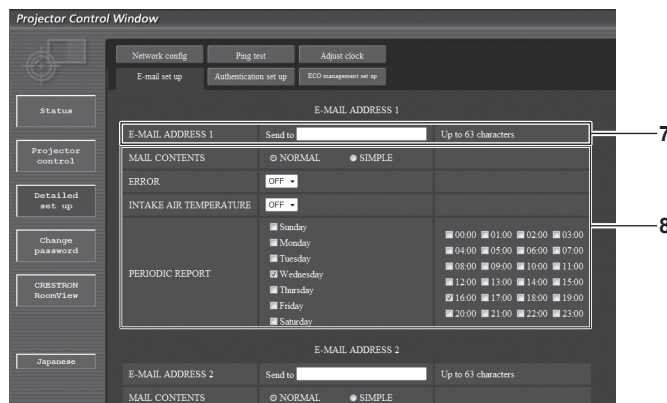

- 7 **[E-MAIL ADDRESS 1]**  
Enter the E-mail address to be sent.

- 8 **Settings of the conditions to send E-mail**  
Select the conditions to send E-mail.  
**[MAIL CONTENTS]:**  
Select either [NORMAL] or [SIMPLE].  
**[ERROR]:**  
Send an E-mail when an error occurred in the self-diagnosis.  
**[INTAKE AIR TEMPERATURE]:**  
Send an E-mail when the air intake temperature has reached the value set at the above field.  
**[PERIODIC REPORT]:**  
Place a check mark on this to send an E-mail periodically. It will be sent on the days and time with the check mark.

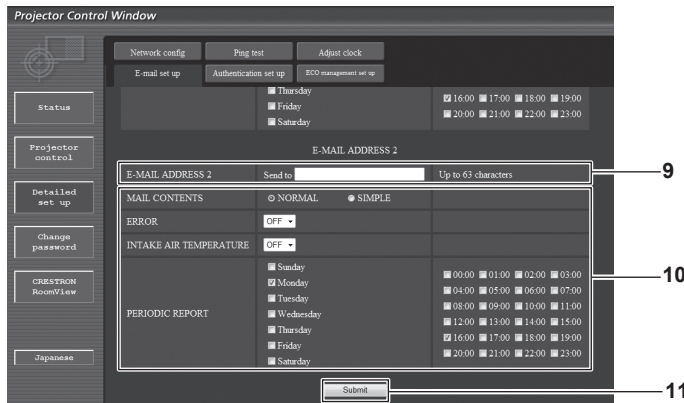

**9 [E-MAIL ADDRESS 2]**

Enter the E-mail address to be sent when two E-mail addresses are to be used.

Leave it blank when two E-mail addresses are not to be used.

**10 Settings of the conditions to send E-mail**

Select the conditions to send E-mail to the second E-mail address.

**[MAIL CONTENTS]:**  
Select either [NORMAL] or [SIMPLE].

**[ERROR]:**  
Send an E-mail when an error occurred in the self-diagnosis.

**[INTAKE AIR TEMPERATURE]:**  
Send an E-mail when the air intake temperature has reached the value set at the above field.

**[PERIODIC REPORT]:**  
Place a check mark on this to send E-mail to the second E-mail address periodically. It will be sent on the days and time with the check mark.

**11 [Submit]**  
Update the settings.

**[Authentication set up] page**

Set the authentication items when POP authentication or SMTP authentication is necessary to send an E-mail.

Click [Detailed set up] → [Authentication set up].

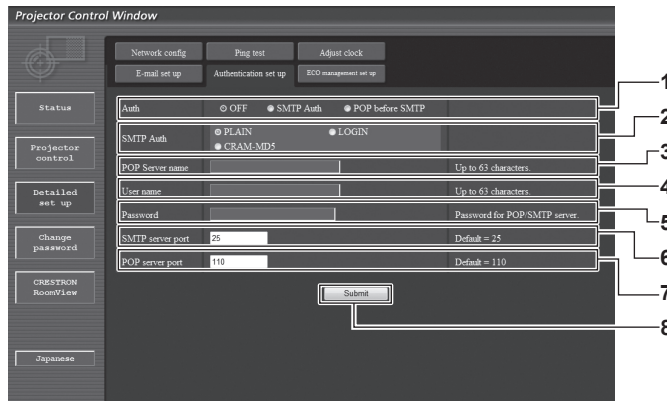

**1 [Auth]**  
Select the authentication method specified by your Internet service provider.

**2 [SMTP Auth]**  
Set when the SMTP authentication is selected.

**3 [POP server name]**  
Enter the POP server name.  
Allowed characters:  
Alphanumerics (A to Z, a to z, 0 to 9)  
Minus sign (-) and period (.)

**4 [User name]**  
Enter the user name for the POP server or the SMTP server.

**5 [Password]**  
Enter the password for the POP server or the SMTP server.

**6 [SMTP server port]**  
Enter the port number of the SMTP server.  
(Normally 25)

**7 [POP server port]**  
Enter the port number of the POP server.  
(Normally 110)

**8 [Submit]**  
Update the settings.

## Contents of E-mail sent

## Example of E-mail sent when E-mail is set

The following E-mail is sent when the E-mail settings have been established.

```

=== Panasonic projector report(CONFIGURE) ===
Projector Type      : RW430
Serial No          : SW1234567

---- E-mail setup data ----
TEMPERATURE WARNING SETUP
MINIMUM TIME      at [ 60] minutes interval
INTAKE AIR TEMPERATURE Over[ 46 degC / 114 degF]

ERROR             [ ON ]
INTAKE AIR TEMPERATURE [ OFF ]

PERIODIC REPORT
Sunday [ ON ] Monday [ ON ] Tuesday [ ON ] Wednesday [ ON ]
Thursday [ ON ] Friday [ ON ] Saturday [ ON ]
00:00 [ ON ] 01:00 [ ON ] 02:00 [ ON ] 03:00 [ ON ]
04:00 [ ON ] 05:00 [ ON ] 06:00 [ ON ] 07:00 [ ON ]
08:00 [ ON ] 09:00 [ ON ] 10:00 [ ON ] 11:00 [ ON ]
12:00 [ ON ] 13:00 [ ON ] 14:00 [ ON ] 15:00 [ ON ]
16:00 [ ON ] 17:00 [ ON ] 18:00 [ ON ] 19:00 [ ON ]
20:00 [ ON ] 21:00 [ ON ] 22:00 [ ON ] 23:00 [ ON ]

---- check system ----
MAIN CPU BUS [ OK ]
FAN [ OK ]
INTAKE AIR TEMPERATURE [ OK ]
OPTICS MODULE TEMPERATURE [ OK ]
INTERNAL AIR TEMPERATURE [ OK ]
LIGHT STATUS [ OK ]
INTAKE AIR TEMP.SENSOR [ OK ]
OPTICS MODULE TEMP.SENSOR [ OK ]
INTERNAL AIR TEMP.SENSOR [ OK ]
BATTERY [ OK ]
PHOSPHOR WHEEL [ OK ]
(Error code 00 00 00 00 00 00 00 00 00 00 00 00 00 00 00)

Intake air temperature      :[ 18 degC / 64 degF ]
Optics module temperature  :[ 30 degC / 86 degF ]
Internal air temperature    :[ 28 degC / 82 degF ]
PROJECTOR RUNTIME          9 H

----- Current status -----
MAIN VERSION      1.00
NETWORK VERSION  1.00
SUB VERSION      1.00
POWER STATUS     POWER=STANDBY
INPUT SIGNAL     DVI-I
SIGNAL NAME      XGA60
SIGNAL FREQUENCY 48.36kHz / 60.00H

---- Wired Network configuration ----
DHCP Client      OFF
IP address       192.168.0.8
MAC address      04:20:9A:00:00:00

Mon Jul 05 14:11:29 2012

---- Memo ----

```

**Example of the E-mail sent for an error**

The following E-mail is sent when an error has occurred.

```

=== Panasonic projector report(ERROR) ===
Projector Type   : RW430
Serial No       : SW1234567

---- check system ----
MAIN CPU BUS           [ OK ]
FAN                   [ OK ]
INTAKE AIR TEMPERATURE [ OK ]
OPTICS MODULE TEMPERATURE [ OK ]
INTERNAL AIR TEMPERATURE [ OK ]
LIGHT STATUS          [ OK ]
INTAKE AIR TEMP.SENSOR [ OK ]
OPTICS MODULE TEMP.SENSOR [ FAILED ]
INTERNAL AIR TEMP.SENSOR [ OK ]
BATTERY               [ OK ]
PHOSPHOR WHEEL        [ OK ]
(Error code 00 00 00 00 00 00 00 00 00 00 02 00 00 00 00)

Intake air temperature   : [ 18 degC / 64 degF ]
Optics module temperature : [ 30 degC / 86 degF ]
Internal air temperature  : [ 28 degC / 82 degF ]
PROJECTOR RUNTIME        9 H

----- Current status -----
MAIN VERSION             1.00
NETWORK VERSION         1.00
SUB VERSION              1.00
POWER STATUS             POWER=STANDBY
INPUT SIGNAL             DVI-I
SIGNAL NAME              XGA60
SIGNAL FREQUENCY         48.36kHz / 60.00H

---- Wired Network configuration ----
DHCP Client              OFF
IP address               192.168.0.8
MAC address              04:20:9A:00:00:00

Mon Jul 05 14:11:29 2012

---- Memo ----
    
```

**[ECO management set up] page**

You can perform settings for the ECO management function of the projector.

Click [Detailed set up] → [ECO management set up].



- 1 **[LIGHT POWER]**  
Select the light source power setting.
- 2 **[AUTO POWER SAVE]**  
Select [ON] to set [AMBIENT LIGHT DETECTION], [SIGNAL DETECTION], and [AV MUTE DETECTION].
- 3 **[AMBIENT LIGHT DETECTION]**  
Enables ([ON])/disables ([OFF]) the ambient light detection function.
- 4 **[SIGNAL DETECTION]**  
Enables ([ON])/disables ([OFF]) the signal detection function.
- 5 **[AV MUTE DETECTION]**  
Enables ([ON])/disables ([OFF]) the AV mute detection function.
- 6 **[NO SIGNAL SHUT-OFF]**  
Select the time until the projector enters the standby mode when the signal detection function is used.
- 7 **[Submit]**  
Update the settings.

**Note**

- For detailed description of each setting item, refer to the [PROJECTOR SETUP] menu of the projector → [ECO MANAGEMENT] (➡ page 77).



**[Change password] page**

Click [Change password].

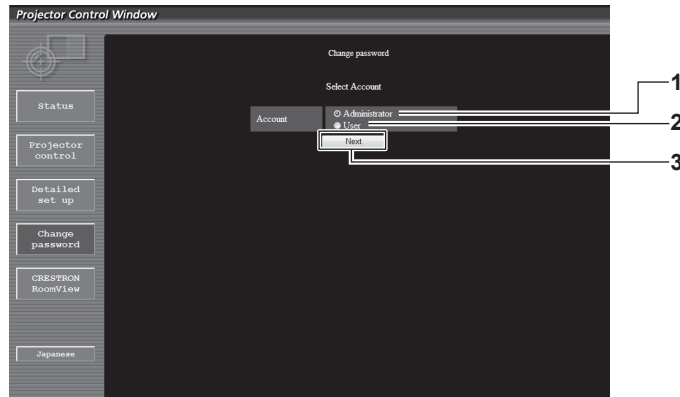

- |   |  |
|---|--|
| <p><b>1 [Administrator]</b><br/>Used to change the setting of the [Administrator].</p> <p><b>2 [User]</b><br/>Used to change the setting of the [User].</p> | <p><b>3 [Next]</b><br/>Used to change the setting of the password.</p> |
|---|--|

**[Administrator] account**

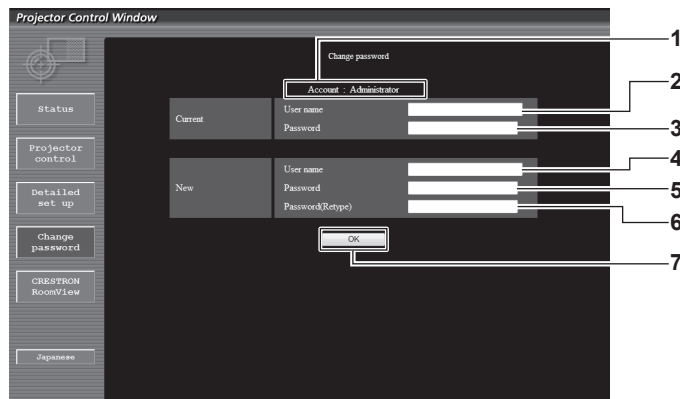

- |  |   |
|--|---|
| <p><b>1 [Account]</b><br/>Displays the account to change.</p> <p><b>2 [Current][User name]</b><br/>Enter the user name before the change.</p> <p><b>3 [Current][Password]</b><br/>Enter the current password.</p> <p><b>4 [New][User name]</b><br/>Enter the desired new user name. (Up to 16 characters in single byte)</p> | <p><b>5 [New][Password]</b><br/>Enter the desired new password. (Up to 16 characters in single byte)</p> <p><b>6 [New][Password(Retyp)]</b><br/>Enter the desired new password again.</p> <p><b>7 [OK]</b><br/>Determines the change of password.</p> |
|--|---|

[User] account

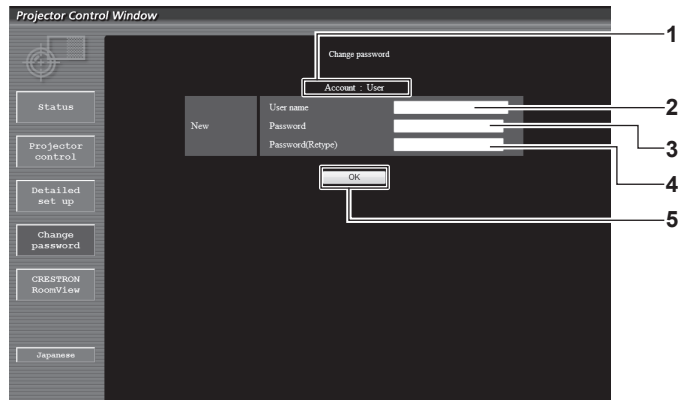

- |  |  |
|--|--|
| <p>1 <b>[Account]</b><br/>Displays the account to change.</p> <p>2 <b>[New][User name]</b><br/>Enter the desired new user name. (Up to 16 characters in single byte)</p> | <p>3 <b>[New][Password]</b><br/>Enter the desired new password. (Up to 16 characters in single byte)</p> <p>4 <b>[New][Password(Retype)]</b><br/>Enter the desired new password again.</p> <p>5 <b>[OK]</b><br/>Determines the change of password.</p> |
|--|--|

[Change password] (For user rights)

Only the change of password is enabled under the user rights.

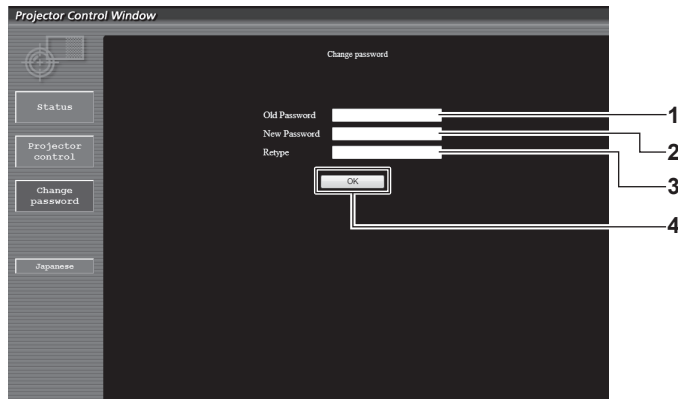

- |  |  |
|--|--|
| <p>1 <b>[Old Password]</b><br/>Enter the current password.</p> <p>2 <b>[New Password]</b><br/>Enter the desired new password. (Up to 16 characters in single byte)</p> | <p>3 <b>[Retype]</b><br/>Enter the desired new password again.</p> <p>4 <b>[OK]</b><br/>Determines the change of password.</p> |
|--|--|

**Note**

- To change the account of the administrator, you must enter the [User name] and [Password] in [Current].

**[CRESTRON RoomView] page**

The projector can be monitored/controlled with RoomView.

To start the RoomView control page from the web control screen, you need to access with the administrator rights. (For user rights, the [CRESTRON RoomView] button is not displayed on the web control screen.)

The control page of RoomView is displayed by clicking [CRESTRON RoomView].

It is not displayed if Adobe Flash Player is not installed on the computer used, or the browser used does not support Flash. In that case, click [Back] on the control page to go back to the previous page.

**Control page**

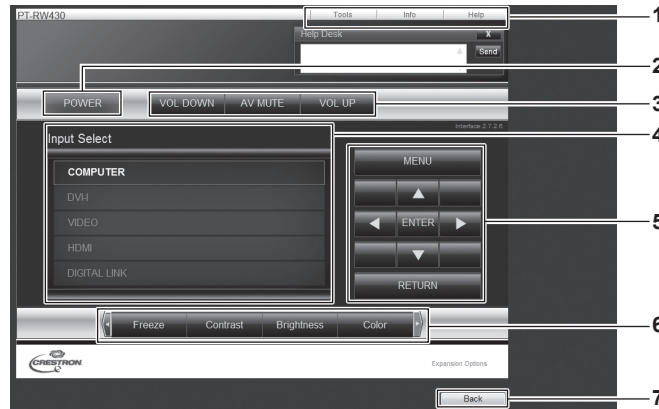

- 1 **[Tools][Info][Help]**  
Tabs for selecting the setting, information, or help page of the projector.
- 2 **[POWER]**  
Switches on/off the power.
- 3 **[VOL DOWN]/[AV MUTE]/[VOL UP]**  
Operate the volume/AV mute.  
These operations are not available when the power of the projector is turned off.
- 4 **[Input Select]**  
Controls input selection.  
Not available when the power of the projector is turned off.
- 5 **Menu screen control buttons**  
Navigates the menu screen.
- 6 **Freeze/image quality adjustment**  
Controls items related to freeze/image quality.
- 7 **[Back]**  
Performs return to the previous page.

**[Tools] page**

Click [Tools] on the control page.

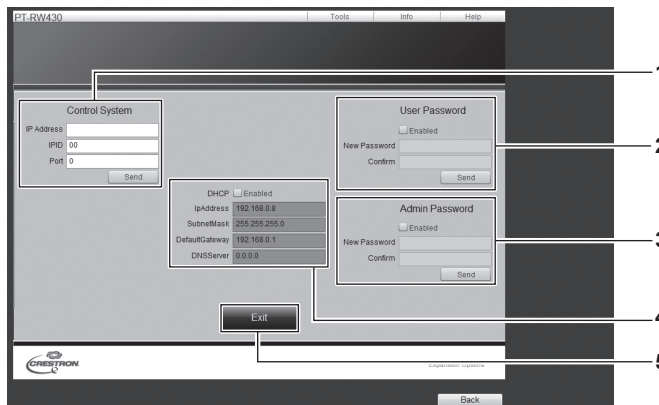

- 1 **[Control System]**  
Set the information required for communicating with the controller to be connected with the projector.
- 2 **[User Password]**  
Set the user rights password for the RoomView control page.
- 3 **[Admin Password]**  
Set the administrator rights password for the RoomView control page.
- 4 **Network status**  
Displays the settings of wired LAN.  
**[DHCP]**  
Displays the current setting.  
**[IP Address]**  
Displays the current setting.  
**[SubnetMask]**  
Displays the current setting.  
**[DefaultGateway]**  
Displays the current setting.  
**[DNSServer]**  
Displays the current setting.
- 5 **[Exit]**  
Returns to the control page.

**[Info] page**

Click [Info] on the control page.

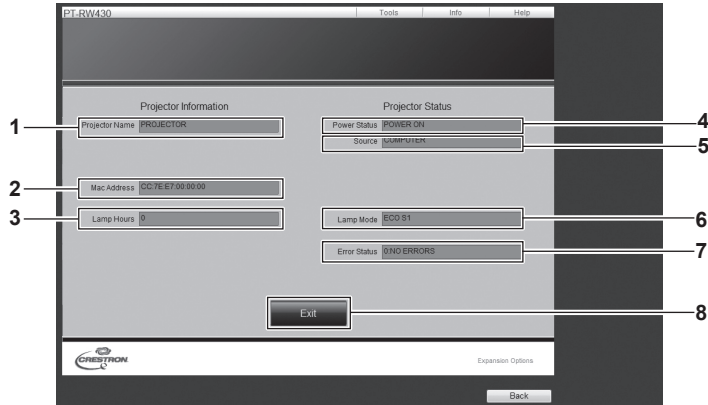

- |  |   |
|--|---|
| <p><b>1 [Projector Name]</b><br/>Displays the projector name.</p> <p><b>2 [Mac Address]</b><br/>Displays the MAC address.</p> <p><b>3 [Lamp Hours]</b><br/>Displays the runtime of the projector (converted value).</p> <p><b>4 [Power Status]</b><br/>Displays the status of the power.</p> | <p><b>5 [Source]</b><br/>Displays the selected image input.</p> <p><b>6 [Lamp Mode]</b><br/>Displays the light source mode.</p> <p><b>7 [Error Status]</b><br/>Displays the error status.</p> <p><b>8 [Exit]</b><br/>Returns to the control page.</p> |
|--|---|

**[Help] page**

Click [Help] on the control page.

The [Help Desk] window is displayed.



- 1 [Help Desk]**  
Send/receive messages to/from an administrator who uses Crestron RoomView.

## [DIGITAL LINK] menu

On the menu screen, select [DIGITAL LINK] from the main menu.  
Refer to “Navigating through the menu” (➔ page 44) for the operation of the menu screen.

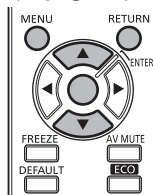

Switch the input to DIGITAL LINK.

### Note

- When the optional digital interface box (Model No.: ET-YFB100G) is connected to the <DIGITAL LINK/LAN> terminal, the main menu of ET-YFB100G is displayed. Refer to the user manual supplied with ET-YFB100G for details.
- When a twisted-pair-cable transmitter of other manufacturer is connected to the projector, the main menu of the projector is displayed.

# Chapter 5 Maintenance

---

This chapter describes inspection when there are problems, and maintenance methods.

# Light source/temperature indicator

## When an indicator lights up

If a problem should occur inside the projector, the light source indicator <LIGHT>/temperature indicator <TEMP> will inform you by lighting or flashing. Check the status of the indicators and manage the indicated problems as follows.

### Attention

- When switching off the projector to deal with problems, make sure to follow the procedure in “Switching off the projector” (➔ page 36).
- Check the status of the power supply with the power indicator <ON (G)/STANDBY (R)>. (➔ page 34)

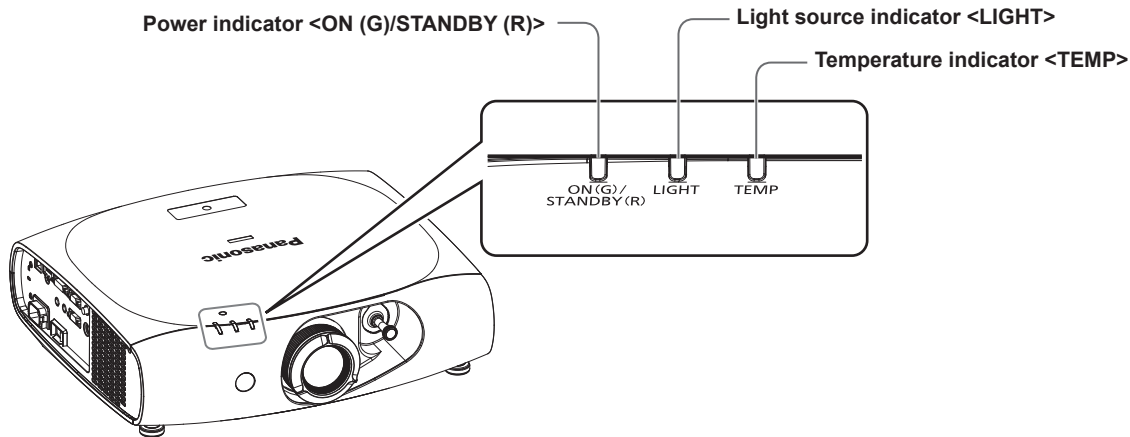

## Light source indicator <LIGHT>

Indicator status	Lighting in red (projecting)	Flashing in red (2 times)	Flashing in red (3 times)
<b>Status</b>	The light source may not light properly.	The light source does not light up or has suddenly turned off.	
<b>Cause</b>	—		
<b>Solution</b>	Turn the <MAIN POWER> switch to <OFF> (➔ page 36), and turn it on again.		

### Note

- If the light source indicator <LIGHT> still lights or is flashing even turning the <MAIN POWER> switch to <OFF> (➔ page 36), ask your dealer to repair the projector.

## Temperature indicator <TEMP>

Indicator status	Lighting in red		Flashing in red (1 time)	Flashing in red (2 times)	Flashing in red (3 times)
<b>Status</b>	Warm-up status	Internal temperature is high (warning).	Internal temperature is high (during projection).	Internal temperature is high (standby warning).	The cooling fan has stopped.
<b>Cause</b>	<ul style="list-style-type: none"> <li>• Did you turn on the power when the room temperature was low (0 °C (32 °F))?</li> </ul>	<ul style="list-style-type: none"> <li>• Is the air intake/exhaust port blocked?</li> <li>• Is the room temperature high?</li> <li>• Is [HIGH ALTITUDE MODE] set correctly?</li> </ul>			—
<b>Solution</b>	<ul style="list-style-type: none"> <li>• Wait at least five minutes in the current status.</li> <li>• Install the projector in a location with an ambient temperature of 0 °C (32 °F) to 45 °C (113 °F)*1.</li> </ul>	<ul style="list-style-type: none"> <li>• Remove any objects that are blocking the air intake/exhaust port.</li> <li>• Install the projector in a location with an ambient temperature of 0 °C (32 °F) to 45 °C (113 °F)*1.</li> <li>• When using the projector at high altitudes between 1 400 m (4 593') and 2 700 m (8 858') above sea level, set [HIGH ALTITUDE MODE] (➔ page 77) to [ON].</li> <li>• Do not install the projector at high altitudes of 2 700 m (8 858') or higher above sea level.</li> </ul>			<ul style="list-style-type: none"> <li>• Turn the &lt;MAIN POWER&gt; switch to &lt;OFF&gt; (➔ page 36), and consult your dealer.</li> </ul>

\*1 When using the projector at high altitudes (1 400 m (4 593') – 2 700 m (8 858') above sea level), the operating environment temperature will be 0 °C (32 °F) – 40 °C (104 °F).

### Note

- If the temperature indicator <TEMP> is still lit or flashing after taking the preceding measures, ask your dealer to repair the projector.

# Maintenance

---

## Before maintaining the projector

---

- Make sure to turn off the power before maintaining the projector. (➔ pages 34, 36)
- When switching off the projector, make sure to follow the procedures in “Switching off the projector” (➔ page 36).

## Maintenance

---

### Outer case

---

Wipe off dirt and dust with a soft, dry cloth.

- If the dirt is persistent, soak the cloth with water and wring it thoroughly before wiping. Dry off the projector with a dry cloth.
- Do not use benzene, thinner, or rubbing alcohol, other solvents, or household cleaners. Doing so may deteriorate the outer case.
- When using chemically treated dust cloths, follow the instructions written on its packaging.

### Lens front surface

---

Wipe off dirt and dust from the front surface of the lens with a soft clean cloth.

- Do not use a cloth that is fluffy, dusty, or soaked with oil/water.
- Since the lens is fragile, do not use excessive force when wiping the lens.

### Attention

---

- The lens is made of glass. Impacts or excessive force when wiping may scratch its surface. Please handle with care.

### Cleaning inside the projector

---

Ask your dealer about cleaning inside the projector every 20 000 hours of usage as an estimated duration.

- If the projector is used in a dusty place, cleaning may be required before the usage time has reached 20 000 hours.
- If the light source goes off or the brightness reduces noticeably, ask your dealer about replacement of the light source unit.



# Troubleshooting

Review the following points. For details, see the corresponding pages.

Problems	Points to be checked	Page
<b>Power does not turn on.</b>	• Is the power plug firmly inserted into the outlet?	—
	• Is the <MAIN POWER> switch set to <OFF>?	36
	• Is the wall outlet supplying electricity?	—
	• Have the circuit breakers tripped?	—
	• Is the temperature indicator <TEMP> or the light source indicator <LIGHT> lit or flashing?	119
<b>No image appears.</b>	• Are connections to external devices correctly performed?	29
	• Is the input selection setting correct?	41, 85
	• Is the [BRIGHTNESS] adjustment setting at a minimum?	50
	• Is the external device that is connected to the projector working properly?	—
	• Is the AV mute function in use?	40
<b>Image is fuzzy.</b>	• Is the lens focus set correctly?	37
	• Is the projection distance appropriate?	27
	• Is the lens dirty?	18
	• Is the projector installed perpendicular to the screen?	—
<b>Color is pale or grayish.</b>	• Is [COLOR] or [TINT] adjusted correctly?	50
	• Is the external device connected to the projector adjusted correctly?	29
	• Is the RGB cable damaged?	—
<b>Remote control does not respond.</b>	• Are the batteries depleted?	—
	• Is the polarity of the batteries set correctly?	24
	• Are there any obstructions between the remote control and the remote control signal receiver of the projector?	22
	• Is the remote control being used beyond its effective operation range?	22
	• Are other forms of light, such as fluorescent light, affecting the projection?	22
	• Is the [REMOTE CONTROL] setting in [CONTROL DEVICE SETUP] set to [DISABLE]?	97
	• Is the ID number setting operation correct?	24
<b>Buttons on the control panel do not operate.</b>	• Is the [CONTROL PANEL] setting in [CONTROL DEVICE SETUP] set to [DISABLE]?	97
<b>Image does not display correctly.</b>	• Is the [SYSTEM SELECTOR] selection set correctly?	53
	• Is there a problem with the video tape or other image sources?	—
	• Is a signal which is not compatible with the projector being input?	130
<b>Image from a computer does not appear.</b>	• Is the cable too long? (Use D-Sub cables that are 10 m (32'10") or shorter.)	—
	• Is the external video output of the laptop computer set correctly? (Ex.: The external output settings may be switched by pressing the "Fn" + "F3" or "Fn" + "F10" simultaneously. Since the method varies depending on the computer type, refer to the user manual provided with your computer.)	—
<b>Image output from DVI-I of the computer does not appear.</b>	• Is the [DVI-I IN] setting set to [EDID3]/[EDID2]?	70
	• The graphics accelerator driver of the computer may need to be updated to the latest version.	—
	• The computer may need to be restarted after performing [DVI-I IN] settings.	70
	• Is the [DIGITAL/ANALOG] setting in [DVI-I IN] correct?	70
<b>Video from HDMI compatible device does not appear or it appears jumbled.</b>	• Is the HDMI cable connected securely?	29
	• Turn the power of the projector and the external device on and off.	—
	• Is a signal which is not compatible with the projector being input?	130
<b>No audio is coming from the HDMI compatible device.</b>	• Set audio of the external device to linear PCM.	—
	• Check [AUDIO IN SELECT] of [AUDIO SETTING].	89
	• If there is no audio through the HDMI cable connection, use the <AUDIO IN> terminal.	89
<b>There is no DIGITAL LINK input audio or video.</b>	• Are the connections between the twisted-pair-cable transmitter and the projector or an external device correctly done?	—
	• Is [DIGITAL LINK MODE] set to [AUTO] or [DIGITAL LINK]? Is it set to [ETHERNET]?	98
<b>3D function is not working.</b>	• Is the [3D INPUT FORMAT] or [3D MODE] setting of [3D SETTINGS] correct?	64
	• Check the 3D eyewear settings.	—
	• Is a signal which is supported by the projector being input?	132

## Chapter 5 Maintenance — Troubleshooting

Problems	Points to be checked	Page
<b>Left and right images are reversed (not showing properly).</b>	• Are the devices synchronized? Check the 3D eyewear settings.	—
	• Change the [LEFT/RIGHT SWAP] setting of [3D SETTINGS].	64
<b>Image in the 3D eyewear flickers.</b>	• Are you within the reception range? Are there any obstructions between the 3D eyewear and the IR transmitter? (when using VESA standard 3D eyewear)	—
<b>3D eyewear is not functioning.</b>	• Are batteries of the 3D eyewear drained? If you use the rechargeable 3D eyewear, charge it. If you use the battery-powered 3D eyewear, replace the battery.	—
	• Is the IR transmitter connected properly? (when using VESA standard 3D eyewear)	—
	• Turn off the projector and turn it on again. (when using VESA standard 3D eyewear)	—
	• Is the [3D MODE] setting of [3D SETTINGS] correct?	64

### Attention

- If problems persist even after checking the preceding points, consult your dealer.

# Chapter 6 **Appendix**

---

This chapter describes specifications and after-sales service for the projector.

# Technical information

## PJLink protocol

The network function of this projector supports the PJLink class 1, and the PJLink protocol can be used to perform projector setting and projector status query operations from a computer.

### Control commands

The following table lists the PJLink protocol commands that can be used to control the projector.

- x characters in tables are non-specific characters.

Command	Control details	Parameter / return string	Remark		
POWR	Power supply control	0	Standby		
		1	Power on		
POWR?	Power supply status query	0	Standby		
		1	Power on		
		2	Preparing for switching off the projector		
		3	Warm-up		
INPT	Input selection	11	COMPUTER		
		12	DVI-I (When [DVI-I IN] is set to [ANALOG])		
		21	VIDEO		
INPT?	Input selection query	31	DVI-I (When [DVI-I IN] is set to [DIGITAL])		
		32	HDMI		
		33	DIGITAL LINK		
AVMT	AV mute control	30	AV mute function off		
AVMT?	AV mute function query	31	AV mute function on		
ERST?	Error status query	xxxxxx	1st byte	Indicates fan errors, and returns 0 - 2.	<ul style="list-style-type: none"> <li>• 0 = No error is detected</li> <li>• 1 = Warning</li> <li>• 2 = Error</li> </ul>
			2nd byte	Indicates light source errors, and returns 0 - 2.	
			3rd byte	Indicates temperature errors, and returns 0 - 2.	
			4th byte	Indicates cover open errors, and returns 0 or 2.	
			5th byte	Returns 0.	
			6th byte	Indicates other errors, and returns 0 - 2.	
LAMP?	Light source status query	ERR1	Undefined command		
INST?	Input selection list query	11 12 21 32 33	When [DVI-I IN] is set to [ANALOG]		
		11 21 31 32 33	When [DVI-I IN] is set to [DIGITAL]		
NAME?	Projector name query	xxxxx	Returns the name set in [PROJECTOR NAME] of [NETWORK SETUP].		
INF1?	Manufacturer name query	Panasonic	Returns manufacturer name.		
INF2?	Model name query	RZ470 RW430	Returns model name.		
INF0?	Other information queries	xxxxx	Returns information such as version number.		
CLSS?	Class information query	1	Returns class for PJLink.		

### PJLink security authentication

The password used for PJLink is the same as that of the password set for web control.

When using the projector without security authentication, do not set a password for web control.

- For specifications related to PJLink, refer to the website of Japan Business Machine and Information System Industries Association.  
URL <http://pjlink.jbmia.or.jp/english/>

## Control commands via LAN

### When web control administrator rights password is set (Protect mode)

#### Connecting

1) Obtain the IP address and port number (Initial set value = 1024) of the projector and request for a connection to the projector.

- You can obtain both the IP address and the port number from the menu screen of the projector.

<b>IP address</b>	Obtain from the main menu → [NETWORK] → [NETWORK STATUS]
<b>Port number</b>	Obtain from the main menu → [NETWORK] → [NETWORK CONTROL] → [COMMAND PORT]

2) Check the response from the projector.

	Data section	Blank	Mode	Blank	Random number section	Termination symbol
<b>Command example</b>	"NTCONTROL" (ASCII string)	' '	'1'	' '	"zzzzzzzz" (ASCII code hex number)	(CR) 0x0d
<b>Data length</b>	9 bytes	1 byte	1 byte	1 byte	8 bytes	1 byte

- Mode: 1 = Protect mode

3) Generate a 32-byte hash value from the following data using MD5 algorithm.

- "xxxxxx:yyyy:zzzzzzzz"

<b>xxxxxx</b>	Administrator rights user name for the web control (default user name is "admin1")
<b>yyyyy</b>	Password of above administrator rights user (default password is "panasonic")
<b>zzzzzzzz</b>	8-byte random number obtained in Step 2)

#### Command transmission method

Transmit using the following command formats.

##### ■ Transmitted data

	Header			Data section	Termination symbol
<b>Command example</b>	Hash value (Refer to "Connecting" above)	'0' 0x30	'0' 0x30	Control command (ASCII string)	(CR) 0x0d
<b>Data length</b>	32 bytes	1 byte	1 byte	Undefined length	1 byte

##### ■ Received data

	Header		Data section	Termination symbol
<b>Command example</b>	'0' 0x30	'0' 0x30	Control command (ASCII string)	(CR) 0x0d
<b>Data length</b>	1 byte	1 byte	Undefined length	1 byte

##### ■ Error response

	String	Details	Termination symbol
<b>Message</b>	"ERR1"	Undefined control command	(CR) 0x0d
	"ERR2"	Out of parameter range	
	"ERR3"	Busy state or no-acceptable period	
	"ERR4"	Timeout or no-acceptable period	
	"ERR5"	Wrong data length	
	"ERRA"	Password mismatch	
<b>Data length</b>	4 bytes	—	1 byte

**When web control administrator rights password is not set (Non-protect mode)**

**Connecting**

**1) Obtain the IP address and port number (Initial set value = 1024) of the projector and request for a connection to the projector.**

- You can obtain both the IP address and the port number from the menu screen of the projector.

<b>IP address</b>	Obtain from the main menu → [NETWORK] → [NETWORK STATUS]
<b>Port number</b>	Obtain from the main menu → [NETWORK] → [NETWORK CONTROL] → [COMMAND PORT]

**2) Check the response from the projector**

	Data section	Blank	Mode	Termination symbol
<b>Command example</b>	“NTCONTROL” (ASCII string)	‘ ’ 0x20	‘0’ 0x30	(CR) 0x0d
<b>Data length</b>	9 bytes	1 byte	1 byte	1 byte

- Mode: 0 = Non-protect mode

**Command transmission method**

Transmit using the following command formats.

**■ Transmitted data**

	Header		Data section	Termination symbol
<b>Command example</b>	‘0’ 0x30	‘0’ 0x30	Control command (ASCII string)	(CR) 0x0d
<b>Data length</b>	1 byte	1 byte	Undefined length	1 byte

**■ Received data**

	Header		Data section	Termination symbol
<b>Command example</b>	‘0’ 0x30	‘0’ 0x30	Control command (ASCII string)	(CR) 0x0d
<b>Data length</b>	1 byte	1 byte	Undefined length	1 byte

**■ Error response**

	String	Details	Termination symbol
<b>Message</b>	“ERR1”	Undefined control command	(CR) 0x0d
	“ERR2”	Out of parameter range	
	“ERR3”	Busy state or no-acceptable period	
	“ERR4”	Timeout or no-acceptable period	
	“ERR5”	Wrong data length	
	“ERRA”	Password mismatch	
<b>Data length</b>	4 bytes	—	1 byte

## <SERIAL IN> terminal

The <SERIAL IN> terminal of the connecting terminal of the projector conforms with RS-232C so that the projector can be connected to and controlled from a computer.

### Connection

#### ● To connect directly

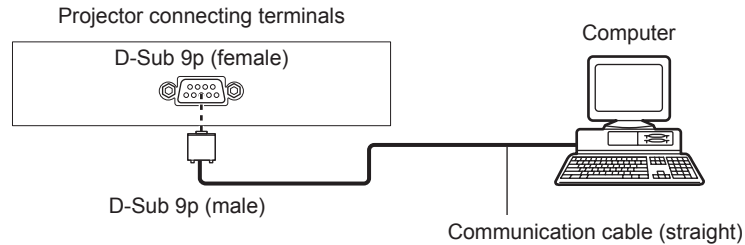

#### ● To connect a DIGITAL LINK compatible device

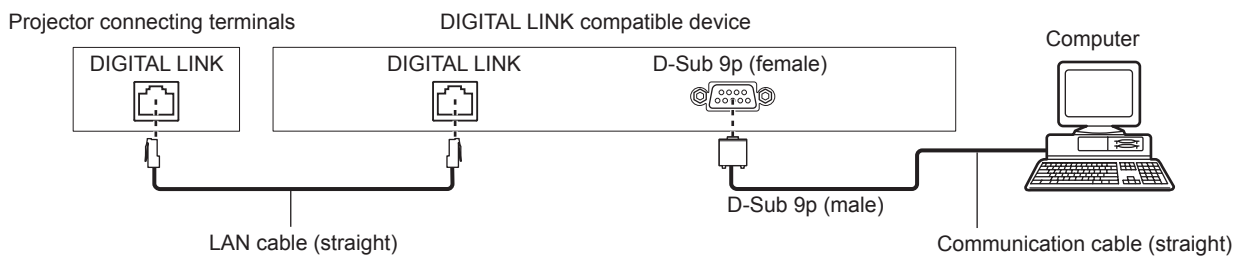

### Note

- The destination of [RS-232C] (➔ page 86) must be set according to the connection method.

### Pin assignments and signal names

D-Sub 9-pin (female) Outside view	Pin No.	Signal name	Details
	(1)	—	NC
	(2)	TXD	Transmitted data
	(3)	RXD	Received data
	(4)	—	NC
	(5)	GND	Earth
	(6)	—	Connected internally
	(7)	CTS	
	(8)	RTS	
	(9)	—	NC

### Communication conditions (Factory default)

Signal level	RS-232C-compliant
Sync. method	Asynchronous
Baud rate	9 600 bps
Parity	None
Character length	8 bits
Stop bit	1 bit
X parameter	None
S parameter	None

**Basic format**

Transmission from the computer starts with STX, then the ID, command, parameter, and ETX are sent in this order. Add parameters according to the details of control.

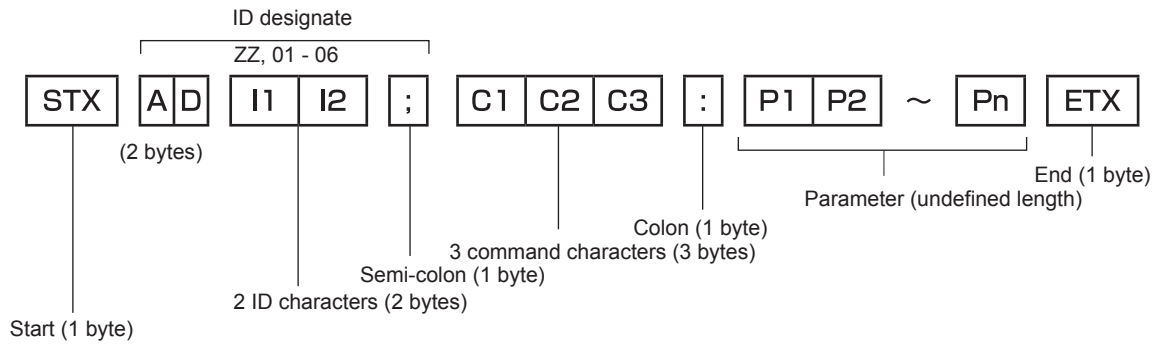

**Basic format (has subcommands)**

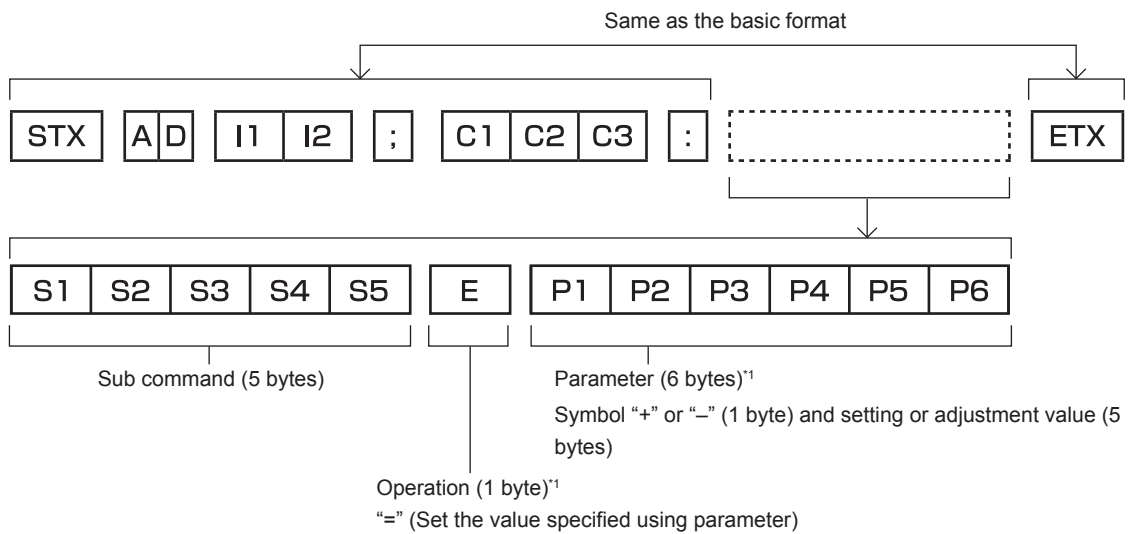

\*1 When transmitting a command which does not need a parameter, an operation (E) and parameter are not necessary.

**Attention**

- If a command is transmitted after the light source starts illuminating, there may be a delay in response or the command may not be executed. Try sending or receiving any command after 60 seconds.
- When transmitting multiple commands, be sure to wait until 0.5 seconds has elapsed after receiving the response from the projector before sending the next command. When transmitting a command which does not need a parameter, a colon (:) is not necessary.

**Note**

- If a command cannot be executed, the "ER401" response is sent from the projector to the computer.
- If an invalid parameter is sent, the "ER402" response is sent from the projector to the computer.
- ID transmission with RS-232C supports ZZ (ALL) and 01 to 06.
- If a command is sent with a specified ID, a response will be sent to the computer only in the following cases.
  - It matches the projector ID
  - The projector's [PROJECTOR ID] (➔ page 76) is [ALL]
- STX and ETX are character codes. STX shown in hexadecimal is 02, and ETX shown in hexadecimal is 03.



## Cable specification

When connected to a computer

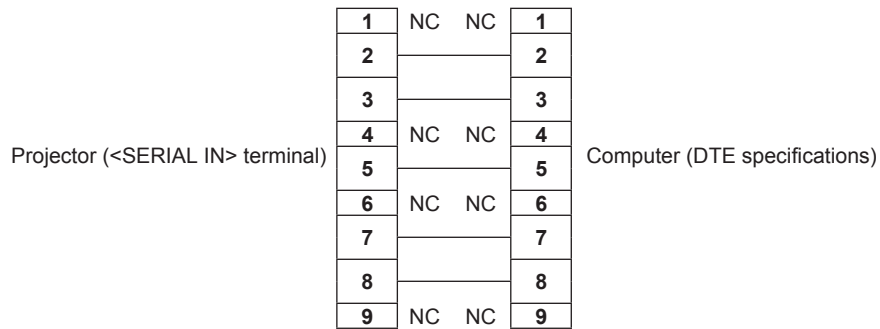

## Control command

The following table lists the commands that can be used to control the projector using a computer.

### ■ Projector control command

Command	Details	Parameter/response string	Remark (parameter)
PON	Power on	—	To check if the power is on, use the “Power query” command.
POF	Power standby		
QPW	Power query	000 001	STANDBY Power on
IIS	Switching the input signal	VID RG1 DVI HD1 DL1	VIDEO COMPUTER DVI-I HDMI DIGITAL LINK
OLP	Light source power settings	0 1	NORMAL LOW
QLP	Light source power settings query	6 7	ECO SAVE1 ECO SAVE2
QST	Projector runtime query	00000 - 99999	In hours
OSH	AV mute	0	EXIT
QSH	AV mute function query	1	OK
VSE	Aspect ratio switch	0 1 2 5	NORMAL 4:3 WIDE NATIVE
QSE	Aspect ratio settings query	6 9 10	FULL H FIT V FIT
OCS	Sub memory switch	01 - 96	Sub memory number
QSB	Sub memory status query		

## Menu lock password

To initialize your password, consult your distributor.

## List of compatible signals

The following table specifies the types of signals compatible with the projector.  
Items that are applicable to 1 to 3 in the table are as follows.

**1 COMPUTER/DVI-I (analog EDID)**

**2 DVI-I digital**

**3 HDMI/DIGITAL LINK**

• Symbols that indicate formats are as follows.

- V: Video
- R: RGB
- Y: YC<sub>B</sub>C<sub>R</sub>/YP<sub>B</sub>P<sub>R</sub>
- D: DVI-I
- H: HDMI

Mode	Resolution (Dots)	Scanning freq.		Dot clock freq. (MHz)	Format	Plug and play*1				
		Horizontal (kHz)	Vertical (Hz)			1	2			3
							EDID1	EDID2	EDID3	
NTSC/NTSC4.43/ PAL-M/PAL60	720 x 480i	15.7	59.9	—	V	—	—	—	—	—
PAL/PAL-N/SECAM	720 x 576i	15.6	50.0	—	V	—	—	—	—	—
525i (480i)	720 x 480i	15.7	59.9	13.5	R/Y	—	—	—	—	—
625i (576i)	720 x 576i	15.6	50.0	13.5	R/Y	—	—	—	—	—
525p (480p)	720 x 483	31.5	59.9	27.0	R/Y/D/H	—	✓	—	✓	✓
625p (576p)	720 x 576	31.3	50.0	27.0	R/Y/D/H	—	✓	—	✓	✓
750 (720)/60p	1 280 x 720	45.0	60.0	74.3	R/Y/D/H	—	✓	—	✓	✓
750 (720)/50p	1 280 x 720	37.5	50.0	74.3	R/Y/D/H	—	✓	—	✓	✓
1125 (1080)/60i <sup>2</sup>	1 920 x 1 080i	33.8	60.0	74.3	R/Y/D/H	—	✓	—	✓	✓
1125 (1080)/50i	1 920 x 1 080i	28.1	50.0	74.3	R/Y/D/H	—	✓	—	✓	✓
1125 (1080)/24p	1 920 x 1 080	27.0	24.0	74.3	R/Y/D/H	—	✓	—	✓	✓
1125 (1080)/24sF	1 920 x 1 080i	27.0	24.0	74.3	R/Y/D/H	—	—	—	—	—
1125 (1080)/25p	1 920 x 1 080	28.1	25.0	74.3	R/Y/D/H	—	✓	—	✓	—
1125 (1080)/30p	1 920 x 1 080	33.8	30.0	74.3	R/Y/D/H	—	—	—	—	—
1125 (1080)/60p	1 920 x 1 080	67.5	60.0	148.5	R/Y/D/H	—	✓	—	✓	✓
1125 (1080)/50p	1 920 x 1 080	56.3	50.0	148.5	R/Y/D/H	—	✓	—	✓	✓
VESA400	640 x 400	37.9	85.1	31.5	R/D/H	—	—	—	—	—
VGA	640 x 400	31.5	70.1	25.2	R/D/H	—	—	—	—	—
	640 x 480	31.5	59.9	25.2	R/D/H	✓	✓	✓	✓	✓
	640 x 480	35.0	66.7	30.2	R/D/H	—	—	—	—	—
	640 x 480	37.9	72.8	31.5	R/D/H	✓	—	✓	✓	✓
	640 x 480	37.5	75.0	31.5	R/D/H	✓	—	✓	✓	✓
	640 x 480	43.3	85.0	36.0	R/D/H	—	—	—	—	—
SVGA	800 x 600	35.2	56.3	36.0	R/D/H	✓	—	✓	✓	✓
	800 x 600	37.9	60.3	40.0	R/D/H	✓	—	✓	✓	✓
	800 x 600	48.1	72.2	50.0	R/D/H	✓	—	✓	✓	✓
	800 x 600	46.9	75.0	49.5	R/D/H	✓	—	✓	✓	✓
	800 x 600	53.7	85.1	56.3	R/D/H	—	—	—	—	—
MAC16	832 x 624	49.7	74.6	57.3	R/D/H	✓	—	✓	✓	✓
XGA	1 024 x 768	39.6	50.0	51.9	R/D/H	—	—	—	—	—
	1 024 x 768	48.4	60.0	65.0	R/D/H	✓	—	✓	✓	✓
	1 024 x 768	56.5	70.1	75.0	R/D/H	✓	—	✓	✓	✓
	1 024 x 768	60.0	75.0	78.8	R/D/H	✓	—	✓	✓	✓
	1 024 x 768	65.5	81.6	86.0	R/D/H	—	—	—	—	—
	1 024 x 768	68.7	85.0	94.5	R/D/H	—	—	—	—	—
	1 024 x 768	80.0	100.0	105.0	R/D/H	—	—	—	—	—
	1 024 x 768	99.0	119.8	137.8	R/D/H	—	—	—	—	—
MXGA	1 152 x 864	64.0	70.0	94.2	R/D/H	—	—	—	—	—
	1 152 x 864	67.5	74.9	108.0	R/D/H	—	—	—	—	—
	1 152 x 864	77.1	85.0	119.7	R/D/H	—	—	—	—	—
MAC21	1 152 x 870	68.7	75.1	100.0	R/D/H	✓	—	✓	✓	✓
MSXGA	1 280 x 960	60.0	60.0	108.0	R/D/H	—	—	—	—	—

Mode	Resolution (Dots)	Scanning freq.		Dot clock freq. (MHz)	Format	Plug and play*1				
		Horizontal (kHz)	Vertical (Hz)			1	2			3
							EDID1	EDID2	EDID3	
SXGA	1 280 x 1 024	64.0	60.0	108.0	R/D/H	✓	—	✓	✓	✓
	1 280 x 1 024	80.0	75.0	135.0	R/D/H	✓	—	✓	✓	✓
	1 280 x 1 024	91.1	85.0	157.5	R/D/H	—	—	—	—	—
SXGA+	1 400 x 1 050	65.2	60.0	122.6	R/D/H	✓	—	✓	✓	✓
	1 400 x 1 050	65.3	60.0	121.8	R/D/H	—	—	—	—	—
	1 400 x 1 050	82.2	75.0	155.9	R/D/H	—	—	—	—	—
UXGA	1 600 x 1 200	75.0	60.0	162.0	R/D/H	✓	—	✓	✓	✓
1280 x 720	1 280 x 720	37.1	49.8	60.5	R/D/H	—	—	—	—	—
	1 280 x 720	44.8	59.9	74.5	R/D/H	—	—	—	—	—
	1 280 x 720	92.6	120.0	161.0	R/D/H	—	—	—	—	—
1280 x 768	1 280 x 768	39.6	49.9	65.3	R/D/H	—	—	—	—	—
	1 280 x 768	47.8	59.9	79.5	R/D/H	—	—	—	—	—
1280 x 800	1 280 x 800	41.3	50.0	68.0	R/D/H	—	—	—	—	—
	1 280 x 800	49.7	59.8	83.5	R/D/H	—	—	—	—	—
WXGA+	1 440 x 900	55.9	59.9	106.5	R/D/H	—	—	—	—	—
WSXGA+	1 680 x 1 050	65.3	60.0	146.3	R/D/H	—	—	—	—	—
1920 x 1080	1 920 x 1 080*3	66.6	59.9	138.5	R/D/H	—	—	—	—	—
WUXGA	1 920 x 1 200*3	74.0	60.0	154.0	R/D/H	✓	—	✓	✓	✓

\*1 Signals with ✓ in the Plug and play columns are signals described in EDID (extended display identification data) of the projector. A signal, which has no ✓ in the Plug and play columns but has an entry in the Format column, can be input. For signals without ✓ in the Plug and play columns, resolution may not be selected in the computer even though the projector supports them.

\*2 When a 1125 (1035)/60i signal was input, it is displayed as a 1125 (1080)/60i signal.

\*3 VESA CVT-RB (Reduced Blanking)-compliant

**Note**

- The number of display dots is 1 920 x 1 080 for the PT-RZ470E series, and 1 280 x 800 for the PT-RW430E series. A signal with a different resolution is converted to the number of display dots.
- The “i” at the end of the resolution indicates an interlaced signal.
- When interlaced signals are connected, flickering may occur on the projected image.
- DIGITAL LINK input compatible signal is the same as HDMI input compatible signal.

## List of 3D compatible signals

The following table specifies the types of 3D video signals compatible with the projector.  
Items that are applicable to 1 to 4 in the table are as follows.

- 1 **Frame packing system**
- 2 **Side by side system**
- 3 **Top and bottom system**
- 4 **Frame sequential system**

3D compatible signal	Resolution (Dots)	Scanning freq.		Dot clock freq. (MHz)	HDMI			DVI-I			COMPUTER
		Horizontal (kHz)	Vertical (Hz)		1	2	3	2 <sup>*1</sup>	3 <sup>*1</sup>	4 <sup>*2</sup>	4
750 (720)/60p	1 280 x 720	45.0	60.0	74.3	✓ <sup>*3</sup>	✓	✓ <sup>*3</sup>	✓ <sup>*4</sup>	✓ <sup>*5</sup>	—	—
750 (720)/50p	1 280 x 720	37.5	50.0	74.3	✓ <sup>*3</sup>	✓ <sup>*4</sup>	✓ <sup>*3</sup>	✓ <sup>*4</sup>	✓ <sup>*5</sup>	—	—
1125 (1080)/60i	1 920 x 1 080i	33.8	60.0	74.3	—	✓ <sup>*3</sup>	—	✓ <sup>*4</sup>	—	—	—
1125 (1080)/50i	1 920 x 1 080i	28.1	50.0	74.3	—	✓ <sup>*3</sup>	—	✓ <sup>*4</sup>	—	—	—
1125 (1080)/24p	1 920 x 1 080	27.0	24.0	74.3	✓ <sup>*3</sup>	✓	✓ <sup>*3</sup>	✓ <sup>*4</sup>	✓ <sup>*5</sup>	—	—
1125 (1080)/60p	1 920 x 1 080	67.5	60.0	148.5	—	✓	—	✓ <sup>*4</sup>	—	—	—
1125 (1080)/50p	1 920 x 1 080	56.3	50.0	148.5	—	✓ <sup>*4</sup>	—	✓ <sup>*4</sup>	—	—	—
XGA	1 024 x 768	80.0	100.0	105.0	—	—	—	—	—	✓ <sup>*6</sup>	✓ <sup>*6</sup>
	1 024 x 768	99.0	119.8	137.8	—	—	—	—	—	✓ <sup>*6</sup>	✓ <sup>*6</sup>
1280 x 720	1 280 x 720	92.6	120.0	161.6	—	—	—	—	—	✓ <sup>*6</sup>	✓ <sup>*6</sup>

\*1 Supports only DVI digital signals.

\*2 Supports DVI digital signals/DVI analog signals.

\*3 HDMI-standard 3D Mandatory format signals

\*4 3D images can be displayed by setting [3D INPUT FORMAT] to [SIDE BY SIDE].

\*5 3D images can be displayed by setting [3D INPUT FORMAT] to [TOP AND BOTTOM].

\*6 3D images can be displayed by setting [3D INPUT FORMAT] to [FRAME SEQUENTIAL].

### Note

- 3D compatible signals for DIGITAL LINK input are the same as compatible signals for HDMI input.

# Specifications

The following table describes the specifications of the projector.

Model No.		PT-RZ470EK/PT-RZ470EW	PT-RW430EK/PT-RW430EW
<b>Power supply</b>		AC 100 V - 240 V 50 Hz/60 Hz	
<b>Power consumption</b>		460 W (5.2 A - 2.0 A)	
		0.5 W when [STANDBY MODE] is set to [ECO] 8 W when [STANDBY MODE] is set to [NORMAL] (when fan is stopped)	
<b>DLP chip</b>	<b>Panel size</b>	16.5 mm (0.65") (aspect ratio 16:9)	16.5 mm (0.65") (aspect ratio 16:10)
	<b>Display system</b>	1-unit DLP chip, DLP type	
	<b>Number of pixels</b>	2 073 600 pixels (1 920 x 1 080 dots)	1 024 000 pixels (1 280 x 800 dots)
<b>Lens</b>	<b>Zoom</b>	1.5 to 2.9:1	1.5 to 3.1:1
	<b>Focus</b>	F = 2.0 to 3.4 f = 21.5 mm to 43.0 mm	
<b>Light source</b>		Hybrid light source (LED/laser diode)	
<b>Light output*1</b>		3 500 lm (ANSI)	
<b>Contrast ratio*1</b>		20 000:1	
<b>Applicable scanning frequency*2</b>	<b>For video signal</b>	Horizontal: 15.75 kHz/15.63 kHz, Vertical: 50 Hz/60 Hz	
	<b>For RGB signal</b>	Horizontal: 15 kHz to 100 kHz, Vertical: 24 Hz to 120 Hz PIAS (Panasonic Intelligent Auto Scanning) system	
		Dot clock frequency 162 MHz or lower	
	<b>For YC<sub>B</sub>C<sub>R</sub>/YP<sub>B</sub>P<sub>R</sub> signal</b>	<ul style="list-style-type: none"> <li>• 525i (480i) Horizontal: 15.75 kHz, Vertical: 60 Hz</li> <li>• 525p (480p) Horizontal: 31.5 kHz, Vertical: 60 Hz</li> <li>• 750 (720)/60p Horizontal: 45 kHz, Vertical: 60 Hz</li> <li>• 1125 (1035)/60i Horizontal: 33.75 kHz, Vertical: 60 Hz</li> <li>• 1125 (1080)/50i Horizontal: 28.13 kHz, Vertical: 50 Hz</li> <li>• 1125 (1080)/24sF Horizontal: 27 kHz, Vertical: 48 Hz</li> <li>• 1125 (1080)/30p Horizontal: 33.75 kHz, Vertical: 30 Hz</li> <li>• 1125 (1080)/50p Horizontal: 56.25 kHz, Vertical: 50 Hz</li> </ul>	<ul style="list-style-type: none"> <li>• 625i (576i) Horizontal: 15.63 kHz, Vertical: 50 Hz</li> <li>• 625p (576p) Horizontal: 31.25 kHz, Vertical: 50 Hz</li> <li>• 750 (720)/50p Horizontal: 37.5 kHz, Vertical: 50 Hz</li> <li>• 1125 (1080)/60i Horizontal: 33.75 kHz, Vertical: 60 Hz</li> <li>• 1125 (1080)/24p Horizontal: 27 kHz, Vertical: 24 Hz</li> <li>• 1125 (1080)/25p Horizontal: 28.13 kHz, Vertical: 25 Hz</li> <li>• 1125 (1080)/60p Horizontal: 67.5 kHz, Vertical: 60 Hz</li> </ul>
		<b>For DVI-D signal</b>	525p (480p), 625p (576p), 750 (720)/60p, 750 (720)/50p, 1125 (1080)/60i, 1125 (1080)/50i, 1125 (1080)/24p, 1125 (1080)/24sF, 1125 (1080)/25p, 1125 (1080)/30p, 1125 (1080)/60p, 1125 (1080)/50p
	<b>For HDMI signal</b>	<ul style="list-style-type: none"> <li>• Displayable resolution: VGA to WUXGA (non-interlaced) WUXGA signal supports only VESA CVT-RB (Reduced Blanking) signal.</li> <li>• Dot clock frequency: 25 MHz to 162 MHz</li> </ul>	
525p (480p), 625p (576p), 750 (720)/60p, 750 (720)/50p, 1125 (1080)/60i, 1125 (1080)/50i, 1125 (1080)/24p, 1125 (1080)/24sF, 1125 (1080)/25p, 1125 (1080)/30p, 1125 (1080)/60p, 1125 (1080)/50p			
		<ul style="list-style-type: none"> <li>• Displayable resolution: VGA to WUXGA (non-interlaced) WUXGA signal supports only VESA CVT-RB (Reduced Blanking) signal.</li> <li>• Dot clock frequency: 25 MHz to 162 MHz</li> </ul>	

\*1 Measurement, measuring conditions and method of notation all comply with ISO21118 international standards.

\*2 Refer to "List of compatible signals" (► page 130) for the types of video signals that can be used with the projector.

## Chapter 6 Appendix — Specifications

Model No.	PT-RZ470EK/PT-RZ470EW	PT-RW430EK/PT-RW430EW
<b>Color system</b>	7 standards (NTSC/NTSC4.43/PAL/PAL-N/PAL-M/SECAM/PAL60)	
<b>Projection screen size</b>	1.02 m (40") to 7.62 m (300")	
<b>Screen aspect ratio</b>	16:9	16:10
<b>Projection method</b>	[FRONT/CEILING], [FRONT/FLOOR], [REAR/CEILING], [REAR/FLOOR]	
<b>Terminal</b>	<b>&lt;COMPUTER IN&gt; terminal</b>	1 set, high-density D-Sub 15 p (female) <b>RGB signal</b> 0.7 V [p-p] 75 Ω (SYNC ON GREEN: 1.0 V [p-p] 75 Ω) SYNC/HD TTL high impedance, automatic positive/negative polarity compatible VD TTL high impedance, automatic positive/negative polarity compatible (SYNC/HD and VD do not support 3 value SYNC.) <b>Y<sub>B</sub>P<sub>R</sub> signal</b> Y: 1.0 V [p-p] including synchronization signal, P <sub>B</sub> P <sub>R</sub> : 0.7 V [p-p] 75 Ω
	<b>&lt;DVI-I IN&gt; terminal</b>	1 set, DVI-I 29 p <b>Digital signal</b> Single link, DVI 1.0 compliant, HDCP compatible <b>RGB signal</b> 0.7 V [p-p] 75 Ω (SYNC ON GREEN: 1.0 V [p-p] 75 Ω) SYNC/HD TTL high impedance, automatic positive/negative polarity compatible VD TTL high impedance, automatic positive/negative polarity compatible <b>Y<sub>B</sub>P<sub>R</sub> signal</b> Y: 1.0 V [p-p] including synchronization signal, P <sub>B</sub> P <sub>R</sub> : 0.7 V [p-p] 75 Ω
	<b>&lt;HDMI IN&gt; terminal</b>	1 set, HDMI 19 pin, HDCP compatible, Deep Color compatible <b>Audio signal</b> Linear PCM (Sampling frequency: 48 kHz/44.1 kHz/32 kHz)
	<b>&lt;VIDEO IN&gt; terminal</b>	1 set, Pin jack 1.0 V [p-p] 75 Ω
	<b>&lt;SERIAL IN&gt; terminal</b>	D-Sub 9 p, 1 set, RS-232C compliant, for computer control
	<b>&lt;VARIABLE AUDIO OUT&gt; terminal</b>	1 set, M3 stereo mini jack (monitor output, with stereo support) 0 V [rms] to 1.8 V [rms] (variable), output impedance 2.2 kΩ or lower
	<b>&lt;AUDIO IN&gt; terminal</b>	1 set, M3 stereo mini jack 0.5 V [rms], input impedance 22 kΩ or higher
	<b>&lt;DIGITAL LINK/LAN&gt; terminal</b>	1 set, for RJ-45 network, DIGITAL LINK connection, PLink compatible, 100Base-TX
	<b>&lt;3D SYNC&gt; terminal</b>	1 set, Mini DIN 3 p, for 3D IR transmitter connection
<b>Power cable length</b>	3.0 m (118-1/8")	
<b>Outer case</b>	Molded plastic	
<b>Dimensions</b>	Width: 455 mm (17-29/32") Height: 137 mm (5-13/32") (with minimum feet length) Depth: 415 mm (16-11/32") (including lens)	
<b>Weight</b>	Approx. 11 kg (24.3 lbs.)*1	
<b>Noise level*2</b>	When [LIGHT POWER] is set to [NORMAL]: 35 dB When [LIGHT POWER] is set to [LOW]: 29 dB	
<b>Operating environment</b>	Operating environment temperature*3: 0 °C (32 °F) to 45 °C (113 °F) Operating environment humidity: 20 % to 80 % (no condensation)	
<b>Remote control</b>	<b>Power supply</b>	DC 3 V (AA/R6/LR6 battery x 2)
	<b>Operating range</b>	Within 15 m (49'2") (when operated directly in front of signal receiver)
	<b>Weight</b>	117 g (4.1 ozs.) (including batteries)
	<b>Dimensions</b>	Width: 48 mm (1-7/8"), Height: 163 mm (6-13/32"), Depth: 24.5 mm (31/32")

\*1 Average value. Weight varies for each product.

\*2 Measurement, measuring conditions and method of notation all comply with ISO21118 international standards.

\*3 When using the projector at high altitudes (1 400 m (4 593') – 2 700 m (8 858') above sea level), the operating environment temperature will be 0 °C (32 °F) – 40 °C (104 °F). When the ambient temperature becomes 35 °C (95 °F) or higher, the output light may be reduced to protect the projector.

### Note

- The model numbers of accessories and optional components are subject to change without notice.

# Dimensions

Unit: mm

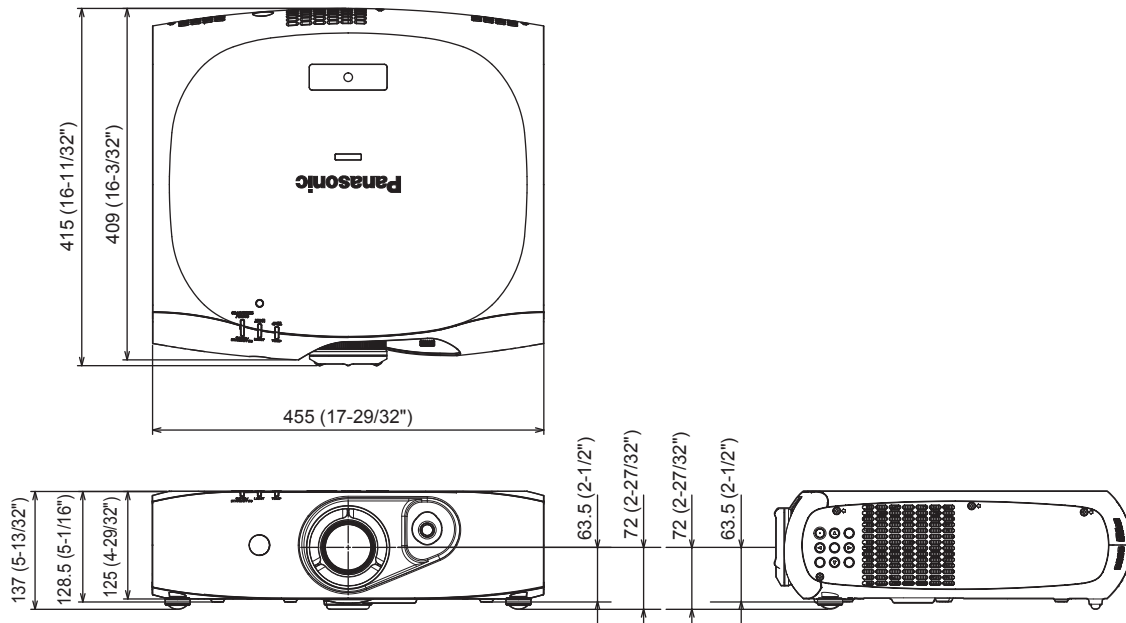

\* Actual dimensions may differ depending on the product.

## Ceiling mount bracket safeguards

- When installing the projector to a ceiling, be sure to use the specified ceiling mount bracket (Model No.: ET-PKR100H (for high ceilings), ET-PKR100S (for low ceilings), ET-PKR100P (for portrait)).
- When installing the projector, attach the drop-prevention kit included with the ceiling mount bracket.
- Ask a qualified technician to do the installation work such as mounting the projector on the ceiling.
- Panasonic takes no responsibility for any damage to the projector resulting from use of a ceiling mount bracket not manufactured by Panasonic or the inappropriate choice of location for installation, even if the warranty period of the projector has not expired.
- Unused products must be removed promptly by a qualified technician.
- Use a torque screwdriver or Allen torque wrench to tighten bolts to their specified tightening torques. Do not use electric screwdrivers or impact screwdrivers.
- For details, read the installation manual that comes with the ceiling mount bracket.
- The model numbers of accessories and optional components are subject to change without notice.

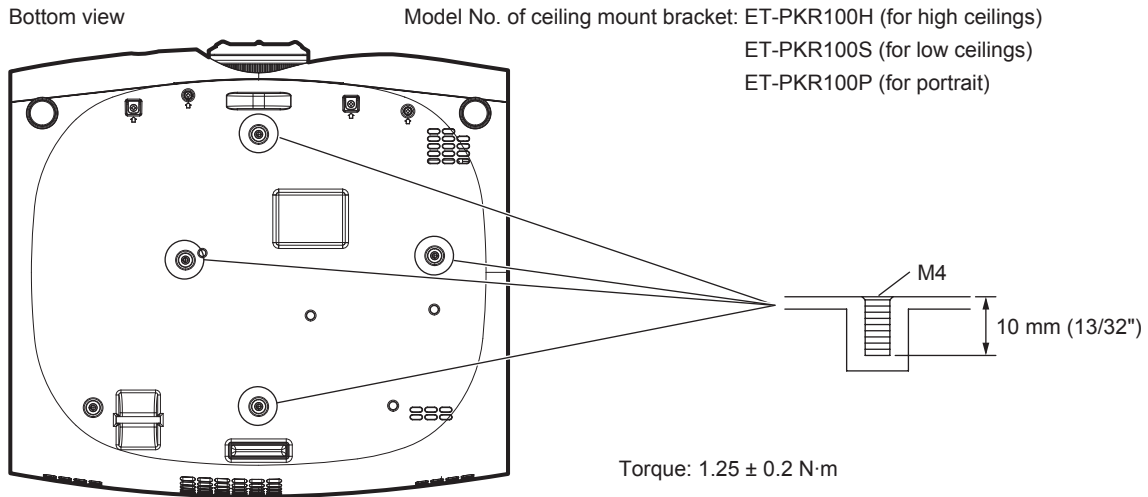



# Index

## 0 – 9

[3D INPUT FORMAT] .....	65
[3D MODE] .....	64
[3D SAFETY PRECAUTIONS] .....	66
[3D SETTINGS] .....	47, 64

## A

Accessories .....	19
<AC IN> terminal .....	22
Adjusting adjustable feet .....	28
Adjusting the volume .....	42
[ADVANCED MENU] .....	46, 58
[ASPECT] .....	55
[AUDIO SETTING] .....	88
[AUTO SETUP] .....	69
<AUTO SETUP> button	
Remote control .....	21, 41
Auto setup function .....	41
[AUTO SIGNAL] .....	69
[AV MUTE] .....	75
<AV MUTE> button	
Remote control .....	21, 40
AV mute function .....	40

## B

[BACK COLOR] .....	74
[BLANKING] .....	58
[BRIGHTNESS] .....	50
[BRIGHTNESS CONTROL] .....	79

## C

Cautions on use .....	18
Cautions when installing .....	15
Cautions when transporting .....	15
Ceiling mount bracket .....	136
Ceiling mount bracket safeguards .....	136
[CLAMP POSITION] .....	59
[CLOCK PHASE] .....	56
[CLOSED CAPTION SETTING] .....	73
[COLOR] .....	50
[COLOR MATCHING] .....	67
[COLOR TEMPERATURE] .....	50
<COMPUTER> button	
Remote control .....	21, 41
[COMPUTER IN] .....	69
Connecting the power cord .....	34
Connecting to a twisted-pair-cable transmitter ...	101
Connection .....	29
[CONTRAST] .....	49
[CONTROL DEVICE SETUP] .....	97
[COOLING CONDITION] .....	77
Crestron RoomView .....	100, 115

## D

[DATE AND TIME] .....	90
[DAYLIGHT VIEW] .....	52
<DEFAULT> button	
Remote control .....	21, 45
Deleting the registered signal .....	94
[DIGITAL CINEMA REALITY] .....	58
DIGITAL LINK .....	18, 117
<DIGITAL LINK> button	
Remote control .....	21, 41
[DIGITAL LINK IN] .....	71
[DIGITAL LINK INPUT] .....	85
[DIGITAL LINK MODE] .....	98
[DIGITAL LINK SETUP] .....	98
[DIGITAL LINK STATUS] .....	99
Dimensions .....	135
Display language .....	47, 63
[DISPLAY OPTION] .....	47, 67
Disposal .....	18
<DVI-I> button	
Remote control .....	21, 41
[DVI-I IN] .....	70

## E

<ECO> button	
Remote control .....	21, 42
[ECO MANAGEMENT] .....	77
[EDGE BLENDING] .....	59
<ENTER> button	
Projector body .....	23
Remote control .....	21

## F

[FRAME RESPONSE] .....	61
[FREEZE] .....	75

<FREEZE> button	
Remote control .....	21, 40
Freeze function .....	40
<FUNC1> - <FUNC3> buttons	
Remote control .....	21, 42
Function button .....	42
[FUNCTION BUTTON] .....	87

## H

<HDMI> button	
Remote control .....	21, 41
[HDMI IN] .....	71
[HIGH ALTITUDE MODE] .....	77

## I

<ID ALL> button	
Remote control .....	21, 24
<ID SET> button	
Remote control .....	21, 24
[INITIALIZE] .....	91
Initial setting .....	20
[INITIAL STARTUP] .....	85
[INPUT RESOLUTION] .....	59
<INPUT SELECT> button	
Projector body .....	23, 41

## K

[KEYSTONE] .....	57
------------------	----

## L

[LEFT/RIGHT SWAP] .....	64
Light source indicator .....	119
List of compatible signals .....	130
[LOAD ALL USER DATA] .....	91

## M

Main menu .....	45
Main power switch .....	22, 35
Maintenance .....	120
<MENU> button	
Projector body .....	23
Remote control .....	21
Menu item .....	46
[MENU LOCK] .....	96
[MENU LOCK PASSWORD] .....	96

## N

Navigating through the menu .....	44
[NETWORK] .....	48, 98
Network connections .....	100
[NETWORK CONTROL] .....	100
[NETWORK SETUP] .....	99
[NETWORK STATUS] .....	100
[NOISE REDUCTION] .....	52

## O

[ON-SCREEN DISPLAY] .....	71
On-screen menu .....	44
Optional accessories .....	19

## P

[PICTURE] .....	46, 49
[PICTURE MODE] .....	49
[POSITION] .....	46, 54
Power button	
Projector body .....	23
Remote control .....	21
Power cord .....	34
Power indicator .....	34
Precautions for use .....	15
Projecting .....	37
[PROJECTION METHOD] .....	26, 76
[PROJECTOR ID] .....	76
[PROJECTOR SETUP] .....	47, 76

## R

[RASTER POSITION] .....	62
Read this first! .....	2
Registering new signals .....	93
Remote control .....	21
Remote control operations .....	40
Renaming the registered signal .....	93
Resetting to the factory default .....	45
<RETURN> button	
Projector body .....	23
Remote control .....	21
RoomView .....	115
[RS-232C] .....	86, 127

## S

[SAFETY PRECAUTIONS MESSAGE] .....	65
[SAVE ALL USER DATA] .....	90
[SCHEDULE] .....	83
[SCREEN SETTING] .....	68
Security .....	17
[SECURITY] .....	48, 95
[SECURITY PASSWORD] .....	95
[SECURITY PASSWORD CHANGE] .....	95
Selecting the input signal .....	37
<SERIAL IN> terminal .....	127
[SERVICE PASSWORD] .....	91
Setting remote control ID numbers .....	24
Setting up .....	26
[SHARPNESS] .....	52
[SHIFT] .....	54
[SIGNAL LIST] .....	48, 93
Specifications .....	133
sRGB-compliant video .....	53
[STARTUP INPUT SELECT] .....	85
[STARTUP LOGO] .....	74
[STATUS] .....	89
[SUB MEMORY LIST] .....	74
Switching off the projector .....	36
Switching on the projector .....	35
Switching the input signal .....	41
[SYSTEM SELECTOR] .....	53

## T

Temperature indicator .....	119
[TEST PATTERN] .....	48, 92
[TEXT CHANGE] .....	96
[TEXT DISPLAY] .....	96
[TINT] .....	50
Troubleshooting .....	121

## V

<VIDEO> button	
Remote control .....	21, 41
<VOLUME+>/<VOLUME-> button	
Remote control .....	21, 42

## Z

[ZOOM] .....	55
--------------	----

## Information for Users on Collection and Disposal of Old Equipment and used Batteries



These symbols on the products, packaging, and/or accompanying documents mean that used electrical and electronic products and batteries should not be mixed with general household waste. For proper treatment, recovery and recycling of old products and used batteries, please take them to applicable collection points, in accordance with your national legislation and the Directives 2002/96/EC and 2006/66/EC.

By disposing of these products and batteries correctly, you will help to save valuable resources and prevent any potential negative effects on human health and the environment which could otherwise arise from inappropriate waste handling.



For more information about collection and recycling of old products and batteries, please contact your local municipality, your waste disposal service or the point of sale where you purchased the items.

Penalties may be applicable for incorrect disposal of this waste, in accordance with national legislation.



### **For business users in the European Union**

If you wish to discard electrical and electronic equipment, please contact your dealer or supplier for further information.

### **Information on Disposal in other Countries outside the European Union**

These symbols are only valid in the European Union. If you wish to discard these items, please contact your local authorities or dealer and ask for the correct method of disposal.

### **Note for the battery symbol (bottom two symbol examples):**

This symbol might be used in combination with a chemical symbol. In this case it complies with the requirement set by the Directive for the chemical involved.