

Operating Instructions Functional Manual

DLP™ Projector Commercial Use

Model No. **PT-RZ370EA**
PT-RW330EA

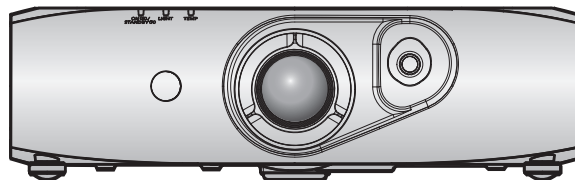

Thank you for purchasing this Panasonic product.

- The Operating Instructions correspond to the firmware's main version 3.02 and higher.
- Before operating this product, please read the instructions carefully and save this manual for future use.
- Before using your projector, be sure to read "Read this first!" (➔ pages 2 to 8).



Read this first!

WARNING: THIS APPARATUS MUST BE EARTHED.

WARNING: To prevent damage which may result in fire or shock hazard, do not expose this appliance to rain or moisture.
This device is not intended for use in the direct field of view at visual display workplaces. To avoid incommoding reflexions at visual display workplaces this device must not be placed in the direct field of view.
The equipment is not intended for used at a video workstation in compliance BildscharbV.

The sound pressure level at the operator position is equal or less than 70 dB (A) according to ISO 7779.

WARNING:

1. Remove the plug from the mains socket when this unit is not in use for a prolonged period of time.
2. To prevent electric shock, do not remove cover. No user serviceable parts inside. Refer servicing to qualified service personnel.
3. Do not remove the earthing pin on the mains plug. This apparatus is equipped with a three prong earthingtype mains plug. This plug will only fit an earthing-type mains socket. This is a safety feature. If you are unable to insert the plug into the mains socket, contact an electrician. Do not defeat the purpose of the earthing plug.

WARNING:

This is a class A product. In a domestic environment this product may cause radio interference in which case the user may be required to take adequate measures.

CAUTION: To assure continued compliance, follow the attached installation instructions, which include using the provided power cord and shielded interface cables when connecting to computer or peripheral device. If you use serial port to connect PC for external control of projector, you must use a commercial RS-232C serial interface cable with ferrite core. Any unauthorized changes or modifications to this equipment will void the user's authority to operate.

This is a device to project images onto a screen, etc., and is not intended for use as indoor lighting in a domestic environment.

Directive 2009/125/EC

Notice on laser

This projector is the Class 1 laser product that complies with IEC 60825-1.

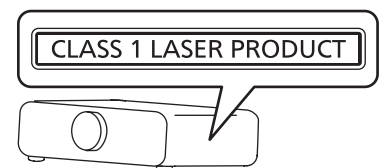

Importer's name and address within the European Union

Panasonic Marketing Europe GmbH
Panasonic Testing Center
Winsbergring 15, 22525 Hamburg, Germany

IMPORTANT: THE MOULDED PLUG (U.K. only)

FOR YOUR SAFETY, PLEASE READ THE FOLLOWING TEXT CAREFULLY.

This appliance is supplied with a moulded three pin mains plug for your safety and convenience. A 13 amp fuse is fitted in this plug. Should the fuse need to be replaced, please ensure that the replacement fuse has a rating of 13 amps and that it is approved by ASTA or BSI to BS1362.

Check for the ASTA mark  or the BSI mark  on the body of the fuse.

If the plug contains a removable fuse cover, you must ensure that it is refitted when the fuse is replaced. If you lose the fuse cover, the plug must not be used until a replacement cover is obtained. A replacement fuse cover can be purchased from an Authorised Service Center.

If the fitted moulded plug is unsuitable for the mains socket in your home, then the fuse should be removed and the plug cut off and disposed of safely. There is a danger of severe electrical shock if the cut off plug is inserted into any 13 amp socket.

If a new plug is to be fitted, please observe the wiring code as shown below.
If in any doubt, please consult a qualified electrician.

WARNING: THIS APPLIANCE MUST BE EARTHED.

IMPORTANT: The wires in this mains lead are coloured in accordance with the following code:

Green - and - Yellow:	Earth
Blue:	Neutral
Brown:	Live

As the colours of the wire in the mains lead of this appliance may not correspond with the coloured markings identifying the terminals in your plug, proceed as follows.

The wire which is coloured GREEN - AND - YELLOW must be connected to the terminal in the plug which is marked with the letter E or by the Earth symbol  or coloured GREEN - AND - YELLOW.

The wire which is coloured BLUE must be connected to the terminal in the plug which is marked with the letter N or coloured BLACK.

The wire which is coloured BROWN must be connected to the terminal in the plug which is marked with the letter L or coloured RED.

How to replace the fuse: Open the fuse compartment with a screwdriver and replace the fuse.

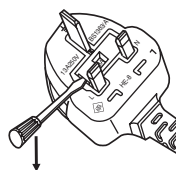

WARNING:

■ POWER

The wall outlet or the circuit breaker shall be installed near the equipment and shall be easily accessible when problems occur. If the following problems occur, cut off the power supply immediately.

Continued use of the projector in these conditions will result in fire or electric shock.

- If foreign objects or water get inside the projector, cut off the power supply.
- If the projector is dropped or the cabinet is broken, cut off the power supply.
- If you notice smoke, strange smells or noise coming from the projector, cut off the power supply.

Please contact an Authorized Service Center for repairs, and do not attempt to repair the projector yourself.

During a thunderstorm, do not touch the projector or the cable.

Electric shocks can result.

Do not do anything that might damage the power cord or the power plug.

If the power cord is used while damaged, electric shocks, short-circuits or fire will result.

- Do not damage the power cord, make any modifications to it, place it near any hot objects, bend it excessively, twist it, pull it, place heavy objects on top of it or wrap it into a bundle.

Ask an Authorized Service Center to carry out any repairs to the power cord that might be necessary.

Completely insert the power plug into the wall outlet and the power connector into the projector terminal.

If the plug is not inserted correctly, electric shocks or overheating will result.

- Do not use plugs which are damaged or wall outlets which are coming loose from the wall.

Do not use anything other than the provided power cord.

Failure to observe this will result in fire or electric shocks. Please note that if you do not use the provided power cord to ground the device on the side of the outlet, this may result in electric shocks.

Clean the power plug regularly to prevent it from becoming covered in dust.

Failure to observe this will cause a fire.

- If dust builds up on the power plug, the resulting humidity can damage the insulation.
- If not using the projector for an extended period of time, pull the power plug out from the wall outlet.

Pull the power plug out from the wall outlet and wipe it with a dry cloth regularly.

Do not handle the power plug and power connector with wet hands.

Failure to observe this will result in electric shocks.

Do not overload the wall outlet.

If the power supply is overloaded (ex., by using too many adapters), overheating may occur and fire will result.

■ ON USE/INSTALLATION

Do not place the projector on soft materials such as carpets or sponge mats.

Doing so will cause the projector to overheat, which can cause burns, fire or damage to the projector.

Do not set up the projector in humid or dusty places or in places where the projector may come into contact with oily smoke or steam, ex. a bathroom.

Using the projector under such conditions will result in fire, electric shocks or deterioration of components.

Deterioration of components (such as ceiling mount brackets) may cause the projector which is mounted on the ceiling to fall down.

Do not install this projector in a place which is not strong enough to take the full weight of the projector or on top of a surface which is sloped or unstable.

Failure to observe this will cause projector to fall down or tip over the projector, and severe injury or damage could result.

WARNING:

Do not cover the air intake/exhaust ports or place anything within 500 mm (20") of them.

Doing so will cause the projector to overheat, which can cause fire or damage to the projector.

- Do not place the projector in narrow, badly ventilated places.
- Do not place the projector on cloth or papers, as these materials could be drawn into the air intake port.

Do not look at the light emitted from the lens while the projector is being used.

Doing so can cause loss of sight.

- Strong light is emitted from the projector's lens. Do not directly look at this light.

Do not expose your eyes and skin to the projection light while the projector is being used.

Possibly hazardous optical radiation is emitted from this product, causing damage to your eyes and skin.

- Be especially careful not to let young children look into the lens. In addition, turn off the power and disconnect the power plug when you are away from the projector.

Never attempt to remodel or disassemble the projector.

High voltages can cause fire or electric shocks.

- For any inspection, adjustment and repair work, please contact an Authorized Service Center.

Doing so may cause exposure to dangerous laser radiation.

- The laser module is built in this projector. Follow procedures specified in the Operating Instructions to make operations and adjustments.

Do not allow metal objects, flammable objects, or liquids to enter inside of the projector. Do not allow the projector to get wet.

Doing so may cause short circuits or overheating, and result in fire, electric shock, or malfunction of the projector.

- Do not place containers of liquid or metal objects near the projector.
- If liquid enters inside of the projector, consult your dealer.
- Particular attention must be paid to children.

Use the ceiling mount bracket specified by Panasonic.

Using the ceiling mount bracket other than the specified one will result in falling accidents.

- Attach the supplied safety cable to the ceiling mount bracket to prevent the projector from falling down.

Installation work (such as ceiling mount bracket) should only be carried out by a qualified technician.

If installation is not carried out and secured correctly, it can cause injury or accidents, such as electric shocks.

- Be sure to use the wire provided with the ceiling mount bracket as an extra safety measure to prevent the projector from falling down. (Install in a different location to the ceiling mount bracket.)

WARNING:

■ **ACCESSORIES**

Do not use or handle the batteries improperly, and refer to the following.

Failure to observe this will cause burns, batteries to leak, overheat, explode or catch fire.

- Use AA/R6/LR6 batteries.
- Do not use unspecified batteries.
- Do not use chargeable batteries.
- Do not disassemble dry cell batteries.
- Do not heat the batteries or place them into water or fire.
- Do not allow the + and – terminals of the batteries to come into contact with metallic objects such as necklaces or hairpins.
- Do not store or carry batteries together with metallic objects.
- Store the batteries in a plastic bag and keep them away from metallic objects.
- Make sure the polarities (+ and –) are correct when inserting the batteries.
- Do not use a new battery together with an old battery or mix different types of batteries.
- Do not use batteries with the outer cover peeling away or removed.

If the battery fluid leaks, do not touch it with bare hands, and take the following measures if necessary.

- Battery fluid on your skin or clothing could result in skin inflammation or injury.
Rinse with clean water and seek medical advice immediately.
- Battery fluid coming in contact with your eyes could result in loss of sight.
In this case, do not rub your eyes. Rinse with clean water and seek medical advice immediately.

Do not use the supplied power cord with devices other than this projector.

- Using the supplied power cord with devices other than this projector may cause short circuits or overheating, and result in electric shock or fire.

Remove the depleted batteries from the remote control promptly.

- Leaving them in the unit may result in fluid leakage, overheating, or explosion of the batteries.

CAUTION:

■ POWER

When disconnecting the power cord, be sure to hold the power plug and power connector.

If the power cord itself is pulled, the lead will become damaged, and fire, short-circuits or serious electric shocks will result.

When not using the projector for an extended period of time, disconnect the power plug from the wall outlet.

Failure to do so may result in fire or electric shock.

Disconnect the power plug from the wall outlet before carrying out any cleaning.

Failure to do so may result in electric shock.

■ ON USE/INSTALLATION

Do not place heavy objects on top of the projector.

Failure to observe this will cause the projector to become unbalanced and fall, which could result in damage or injury. The projector will be damaged or deformed.

Do not put your weight on this projector.

You could fall or the projector could break, and injury will result.

- Be especially careful not to let young children stand or sit on the projector.

Do not place the projector in extremely hot locations.

Doing so will cause the outer casing or internal components to deteriorate, or result in fire.

- Take particular care in locations exposed to direct sunlight or near stoves.

Do not place your hands or other objects close to the air exhaust port.

Doing so will cause burns or damage your hands or other objects.

- Heated air comes out of the air exhaust port. Do not place your hands or face, or objects which cannot withstand heat close to this port.

Always disconnect all cables before moving the projector.

Moving the projector with cables still attached can damage the cables, which will cause fire or electric shocks to occur.

When mounting the projector on the ceiling, keep mounting screws and power cord from contact with metal parts inside the ceiling.

Contact with metal parts inside the ceiling can cause electric shocks.

■ ACCESSORIES

Ask your dealer about cleaning inside the projector every 20 000 hours of usage as an estimated duration.

Continuous use while dust is accumulated inside the projector may result in fire.

- For cleaning fee, ask your dealer.

When not using the projector for an extended period of time, remove the batteries from the remote control.

Failure to observe this will cause the batteries to leak, overheat, catch fire or explode, which may result in fire or contamination of surrounding area.



To remove the battery

Remote Control Battery

1. Press the guide and lift the cover.

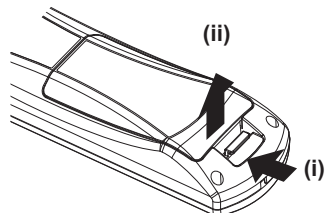

2. Remove the batteries.

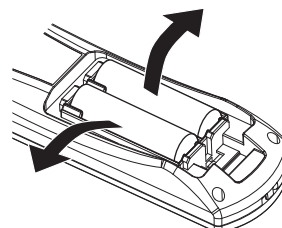

■ Trademarks

- SOLID SHINE is a trademark of Panasonic Corporation.
- Windows®, Windows Vista®, and Internet Explorer® are registered trademarks or trademarks of Microsoft Corporation in the United States and other countries.
- Mac, Mac OS, OS X, and Safari are registered trademarks of Apple Inc. in the United States and other countries.
- PJLink™ is a registered trademark or pending trademark in Japan, the United States, and other countries and regions.
- HDMI, the HDMI Logo, and High-Definition Multimedia Interface are trademarks or registered trademarks of HDMI Licensing LLC in the United States and other countries.
- VGA and XGA are trademarks of International Business Machines Corporation in the United States.
- SVGA is a trademark or registered trademark of Video Electronics Standards Association.
- RoomView and Crestron RoomView are registered trademarks of Crestron Electronics, Inc.
Crestron Connected and Fusion RV are trademarks of Crestron Electronics, Inc.
- Adobe Flash Player is a trademark or registered trademark of Adobe Systems Inc. in the United States and/or in other countries.
- All other names, company names, and product names mentioned in this manual are trademarks or registered trademarks of their respective owners.

Please note that the ® and TM symbols are not specified in this manual.

■ Illustrations in this manual

- Illustrations of the projector, screen, and other parts may vary from the actual product.

■ Reference pages

- Reference pages in this manual are indicated as (➡ page 00).

■ Term

- In this manual, the “Wireless remote control unit” accessory is referred to as “Remote control”.

Features of the Projector

Easy setup and improved serviceability

- ▶ A highly flexible setup is achieved with a 2x zoom lens, wide range of the lens shift, and DIGITAL LINK (➔ page 16) compatibility.

Long-life reliability achieved

- ▶ The reliability is enhanced through the power-driving and unique cooling control system that maximizes the life of the light source and complete hermeticity of the light source unit, achieving the long-time maintenance-free projector.

Energy conservation achieved through the ECO function

- ▶ The function to reduce power consumption is installed, which is optimizing the light source power according to the brightness of the surroundings, input signal, and video mute status.

Quick Steps

For details, refer to the corresponding pages.

1. **Set up the projector.**
(➔ page 25)



2. **Connect with external devices.**
(➔ page 28)



3. **Connect the power cord.**
(➔ page 33)



4. **Switch on the projector.**
(➔ page 34)



5. **Make initial settings.**
(➔ page 19)
 - Take this step when you switch on the power for the first time after purchasing the projector.



6. **Select the input signal.**
(➔ page 36)



7. **Adjust the image.**
(➔ page 36)

Contents

Be sure to read “Read this first!” from page 2.

Read this first!	2	Operating with the remote control	38
Chapter 1 Preparation		Using the AV mute function	38
Precautions for use	14	Using the Freeze function	38
Cautions when transporting.....	14	Switching the input	39
Cautions when installing.....	14	Using the Automatic setup function	39
Security	15	Using the Function button	40
DIGITAL LINK.....	16	Using the ECO management function.....	40
Disposal.....	16	Adjusting the volume	40
Cautions on use	16	Chapter 4 Settings	
Accessories	17	Menu navigation	42
Optional accessories	18	Navigating through the menu	42
Start-up display	19	Main menu.....	43
Initial setting (display language)	19	Sub-menu.....	44
Initial setting (projector setup)	19	[PICTURE] menu	47
About your projector	20	[PICTURE MODE].....	47
Remote control	20	[CONTRAST].....	47
Projector body	21	[BRIGHTNESS].....	48
Using the remote control	23	[COLOR].....	48
Inserting and removing the batteries	23	[TINT]	48
Setting the remote control ID numbers.....	23	[COLOR TEMPERATURE].....	48
Chapter 2 Getting Started		[DAYLIGHT VIEW].....	50
Setting up	25	[SHARPNESS]	50
Projection method	25	[NOISE REDUCTION].....	50
Parts for ceiling mount (optional).....	25	[SYSTEM SELECTOR]	51
Screen size and throw distance	26	sRGB-compliant video.....	51
Adjusting adjustable feet	27	[POSITION] menu	52
Connecting	28	[SHIFT]	52
Before connecting	28	[ASPECT].....	53
Connecting example: AV equipment	29	[ZOOM].....	53
Connecting example: Computers	30	[CLOCK PHASE].....	54
Connecting example: Twisted-pair-cable transmitter	30	[KEystone].....	55
Chapter 3 Basic Operations		[ADVANCED MENU] menu	56
Switching on/off the projector	33	[DIGITAL CINEMA REALITY]	56
Connecting the power cord	33	[BLANKING]	56
Power indicator.....	33	[INPUT RESOLUTION]	57
Switching on the projector	34	[CLAMP POSITION].....	57
Making adjustments and selections	35	[FRAME RESPONSE].....	58
Switching off the projector	35	[RASTER POSITION].....	58
Projecting	36	[DISPLAY LANGUAGE] menu	59
Selecting the input signal	36	Changing the display language	59
Adjusting the image.....	36		
Adjustment range by the lens position shift (optical shift).....	37		

[DISPLAY OPTION] menu.....	60	[NETWORK] menu	89
[COLOR MATCHING].....	60	[DIGITAL LINK MODE]	89
[SCREEN SETTING] (only for PT-RW330EA)	61	[DIGITAL LINK SETUP].....	89
[AUTO SIGNAL]	62	[DIGITAL LINK STATUS]	90
[AUTO SETUP].....	62	[NETWORK SETUP]	91
[COMPUTER IN]	62	[NETWORK CONTROL]	91
[DVI-I IN].....	63	[NETWORK STATUS]	92
[HDMI IN].....	64	Network connections	92
[DIGITAL LINK IN]	64	Connecting to a twisted-pair-cable transmitter	93
[ON-SCREEN DISPLAY].....	64	Accessing from the web browser	94
[CLOSED CAPTION SETTING] (NTSC input only).....	66	[DIGITAL LINK] menu	108
[BACK COLOR].....	67	Chapter 5 Maintenance	
[STARTUP LOGO].....	67	Light source/temperature indicator	110
[SUB MEMORY LIST]	68	Managing the indicated problems	110
[FREEZE]	68	Maintenance.....	112
[AV MUTE].....	69	Before maintaining the projector	112
[PROJECTOR SETUP] menu	70	Maintenance.....	112
[PROJECTOR ID].....	70	Troubleshooting	113
[PROJECTION METHOD].....	70	Chapter 6 Appendix	
[COOLING CONDITION].....	71	Technical information	116
[HIGH ALTITUDE MODE].....	71	PJLink protocol.....	116
[ECO MANAGEMENT].....	71	Control commands via LAN.....	117
[SCHEDULE].....	73	<SERIAL IN> terminal	119
[INITIAL STARTUP].....	75	Menu lock password.....	121
[STARTUP INPUT SELECT]	75	List of compatible signals	122
[DIGITAL LINK INPUT].....	76	Specifications	124
[RS-232C].....	76	Dimensions	126
[FUNCTION BUTTON].....	78	Ceiling mount bracket safeguards.....	127
[AUDIO SETTING]	78	Index	128
[STATUS].....	80		
[DATE AND TIME]	80		
[SAVE ALL USER DATA]	81		
[LOAD ALL USER DATA]	81		
[INITIALIZE].....	82		
[SERVICE PASSWORD].....	82		
[TEST PATTERN] menu	83		
[TEST PATTERN]	83		
[SIGNAL LIST] menu	84		
Registering a signal to the list	84		
Renaming the registered signal.....	84		
Deleting the registered data	85		
[SECURITY] menu	86		
[SECURITY PASSWORD].....	86		
[SECURITY PASSWORD CHANGE]	86		
[TEXT DISPLAY]	87		
[TEXT CHANGE].....	87		
[MENU LOCK].....	87		
[MENU LOCK PASSWORD]	87		
[CONTROL DEVICE SETUP].....	88		

Chapter 1 Preparation

This chapter describes things you need to know or check before using the projector.

Precautions for use

Cautions when transporting

- When transporting the projector, hold it securely by its bottom and avoid excessive vibration and impacts. Doing so may damage the internal components and result in malfunctions.
- Do not transport the projector with the adjustable feet extended. Doing so may damage the adjustable feet.

Cautions when installing

■ Do not set up the projector outdoors.

The projector is designed for indoor use only.

■ Do not set up the projector in the following locations.

- Places where vibration and impacts occur such as in a car or vehicle: Doing so may cause damage to internal components or malfunction.
- Near the exhaust of an air conditioner: Depending on the conditions of use, the screen may fluctuate in rare cases due to the hot air from the air exhaust port or the heated or cooled air. Make sure that the exhaust from the projector or other equipment, or the air from the air conditioner does not blow toward the front of the projector.
- Near lights (studio lamps, etc.) and other locations with severe temperature fluctuations (“Operating environment” (→ page 125)): Placing the projector in these locations may result in malfunctions and the deformation of the outer case.
- Near high-voltage power lines or near motors: Doing so may interfere with the operation of the projector.
- Place where there is high-power laser equipment: Directing a laser beam onto the lens surface causes damage to the DLP chips.

■ Be sure to ask a specialized technician or your dealer when installing the product to a ceiling.

The optional ceiling mount bracket is required.

Model No.: ET-PKR100H (for high ceilings), ET-PKR100S (for low ceilings)

■ Ask a qualified technician or your dealer to install the cable wiring for DIGITAL LINK connection.

Image and sound may be disrupted if cable transmission characteristics can not be obtained due to inadequate installation.

■ The projector may not work properly due to strong radiowave from the broadcast station or the radio.

If there is any facility or equipment, which outputs strong radiowave, near the installation location, install the projector at a location sufficiently far from the source of the radiowave. Or, wrap the LAN cable connected to the <DIGITAL LINK/LAN> terminal by using a piece of metal foil or a metal pipe, of which is grounded at both ends.

■ Lens focus

The high clarity projection lens is thermally affected by the light from the light source, making the focus unstable in the period just after switching on the power. Wait at least 30 minutes with the image projected before adjusting the lens focus.

■ Make sure to set [HIGH ALTITUDE MODE] to [ON] when using the projector at elevations between 1 400 m (4 593') and 2 700 m (8 858') above sea level.

Failure to do so may shorten the life of the components and result in malfunctions.

■ Make sure to set [HIGH ALTITUDE MODE] to [OFF] when using the projector at elevations lower than 1 400 m (4 593') above sea level.

Failure to do so may shorten the life of the components and result in malfunctions.

■ Do not install the projector at elevations of 2 700 m (8 858') or higher above sea level.

Doing so may shorten the life of the internal components and result in malfunctions.

■ Do not use the projector tilted to the right or left.

Using the projector at a vertical angle that exceeds 15° may reduce product life or result in malfunction.

■ **When installing and using the projector at an angle that exceeds 30° vertically, set [COOLING CONDITION] (➔ page 71).**

Failure to observe this will result in malfunctions or shorten the life of the internal components.

■ **Cautions when setting up the projector**

- To install and use the projector via a method that does not use the adjustable feet in a floor standing installation, fix the projector using the four screw holes for ceiling mounting (as shown in the figure).
(Screw diameter: M4, tapping depth inside the set: 10 mm (13/32"), torque: 1.25 ± 0.2 N·m)
Make a clearance of at least 12 mm (15/32") between the projector bottom and setting surface by inserting spacers (metallic) etc. between them.
- Use the adjustable feet only for the floor standing installation and for adjusting the angle. Using it for other purposes may damage the set.

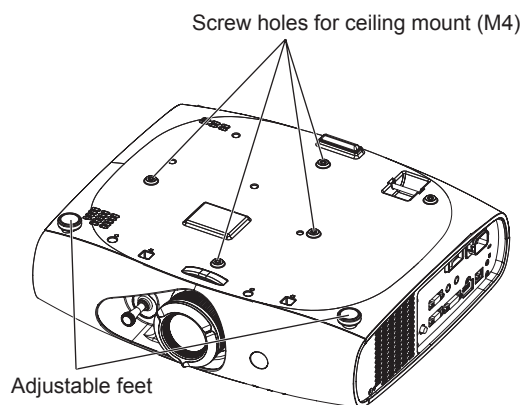

The positions of screw holes for ceiling mount and adjustable feet

- Do not stack projectors on top of each other.
- Do not block the ventilation ports (intake and exhaust) of the projector.
- Prevent hot and cool air from the air conditioning system to blow directly to the ventilation ports (intake and exhaust) of the projector.

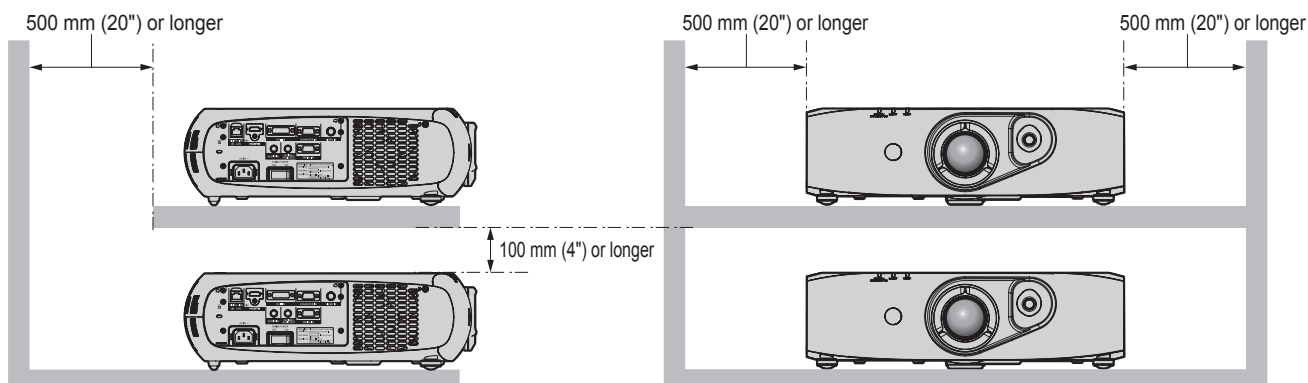
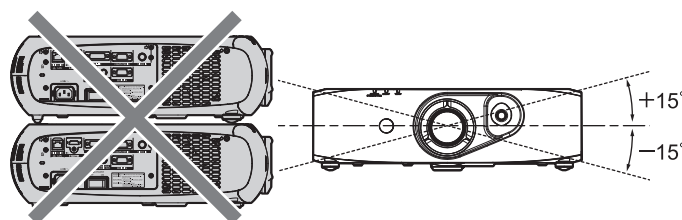

- Do not install the projector in a confined space.
When it is necessary to install the projector in a confined space, install the air conditioning or ventilation separately. Exhaust heat may accumulate when the ventilation is not enough, triggering the protection circuit of the projector.

Security

When using this product, take safety measures against the following incidents.

- Personal information being leaked via this product
- Unauthorized operation of this product by a malicious third party

- Interfering or stopping of this product by a malicious third party

Take sufficient security measures. (➔ pages 86, 104)

- Make your password difficult to guess as much as possible.
- Change your password periodically.
- Panasonic Corporation or its affiliate companies will never ask for your password directly. Do not divulge your password in case you receive such inquiries.
- The connecting network must be secured by a firewall, etc.
- Set a password for the web control and restrict the users who can log in.

DIGITAL LINK

“DIGITAL LINK” is a technology that uses a twisted-pair-cable to transmit video, audio, Ethernet, and serial control signals. The projector supports the optional digital interface box (Model No.: ET-YFB100G), and the “XTP transmitter” of Extron Electronics. For twisted-pair-cable transmitter of other manufacturers of which the operation has been verified with the DIGITAL LINK compatible projector, refer to Panasonic website (<http://panasonic.net/avc/projector/>). Note that the verification for devices of other manufacturers has been made for the items set by Panasonic Corporation, and not all the operations have been verified. For operation or performance problems caused by the devices of other manufacturers, contact the respective manufacturers.

Disposal

To dispose of the product, ask your local authorities or dealer for correct methods of disposal.

Cautions on use

■ To get a good picture quality

- In order to view a beautiful image in higher contrast, prepare an appropriate environment. Draw curtains or blinds over windows and turn off any lights near the screen to prevent outside light or light from indoor lamps from shining onto the screen.
- The high clarity projection lens is thermally affected by the light from the light source, making the focus unstable in the period just after switching on the power. The focus stabilizes when an image is projected continuously for 30 minutes or more.

■ Do not touch the surface of the projection lens with your bare hands.

If the surface of the projection lens becomes dirty from fingerprints or anything else, this will be magnified and projected onto the screen.

■ DLP chips

- The DLP chips are precision-made. Note that in rare cases, pixels of high precision could be missing or always lit. Note that such phenomena does not indicate malfunction.
- Directing a high-power laser beam onto the lens surface can damage the DLP chips.

■ Light source

The light source of the projector uses LED and lasers, and has the following characteristics.

- The luminance of the light source will decrease by duration of usage.
The usage time until when the luminance of the light source decreases by half is approximately 20 000 hours. 20 000 hours is the estimated duration, and it varies depending on individual differences and usage conditions.
If the light source goes off or the brightness reduces noticeably, ask your dealer about replacement of the light source unit.

■ Computer and external device connections

- When connecting a computer or an external device, use power cords and shielded cables following instructions in this manual.
- Use a commercial DVI-D cable with a ferrite core.

Accessories

Make sure that the following accessories are provided with your projector. Numbers enclosed in < > show the number of accessories.

Wireless remote control unit <1>
(N2QAYB000812)

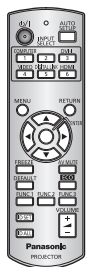

Power cord <1>
(TXFSX01RXRZ)

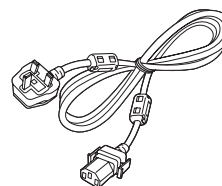

Power cord <1>
(TXFSX01RXQZ)

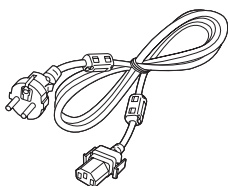

CD-ROM <1>
(TXFQB02VLF1)



AA/R6 or AA/LR6 battery <2>

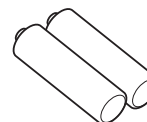

(For remote control unit)

Attention

- After unpacking the projector, discard the power cord cap and packaging material properly.
- Use the supplied power cord only with the projector.
- For missing accessories, consult your dealer.
- Store small parts in an appropriate manner, and keep them away from small children.

Note

- The model numbers of accessories are subject to change without prior notice.

Contents of the supplied CD-ROM

The contents of the supplied CD-ROM are as follows.

Instruction/list (PDF)	Operating Instructions – Functional Manual	
	Multi Projector Monitoring & Control Software Operation Manual	
	Logo Transfer Software Operating Instructions	
	List of Compatible Projector Models	This is a list of projectors that are compatible with the software contained in the CD-ROM and their restrictions.
Software	Multi Projector Monitoring & Control Software (Windows)	This software allows you to monitor and control multiple projectors connected to the LAN.
	Logo Transfer Software (Windows)	This software allows you to create original images, such as company logos to be displayed when projection starts, and transfer them to the projector.

Optional accessories

Optional accessories (product name)	Model No.
Ceiling mount bracket	ET-PKR100H (for high ceilings), ET-PKR100S (for low ceilings)
Digital interface box	ET-YFB100G

Note

- The model numbers of optional accessories are subject to change without prior notice.

Start-up display

The initial setting screen is displayed when the projector is switched on for the first time after purchase as well as when [ALL USER DATA] (➔ page 82) in [INITIALIZE] is executed. Set them in accordance with circumstances.

In other occasions, you can change the settings by menu operations.

Note

- When the projector is used for the first time, you may be required to adjust the lens zoom ring and focus ring of the projector (➔ page 21) to display the menu screen clearly.
Refer to “Adjusting the image” (➔ page 36) for details.

Initial setting (display language)

Select the language to show on the screen. (➔ page 59)

1) Press ▲▼ to select the display language.

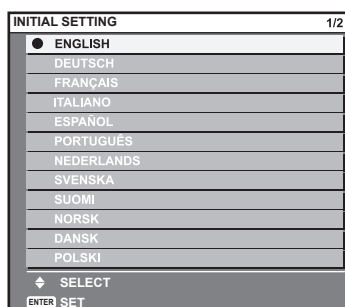

2) Press the <ENTER> button to proceed to the initial setting.

Initial setting (projector setup)

Set each item.

1) Press ▲▼ to select an item.

2) Press ◀▶ to switch the setting.

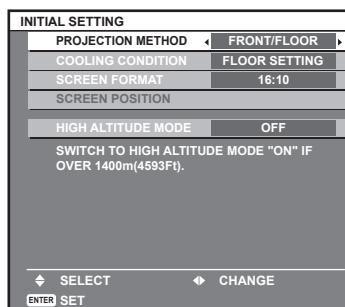

- Refer to the following page for details of each item.
[PROJECTION METHOD] (➔ page 70)
[COOLING CONDITION] (➔ page 71)
[SCREEN FORMAT] (➔ page 61)
[SCREEN POSITION] (➔ page 61)
[HIGH ALTITUDE MODE] (➔ page 71)

3) Press the <ENTER> button.

- Fix the setting value to complete the initial setting.

Note

- If you press the <RETURN> button in the initial setting (display language) screen, you can go back to the initial setting (display language) screen.
- [SCREEN FORMAT] and [SCREEN POSITION] can only be set on PT-RW330EA.
- To continue operations after completed the initial setting (projector setup), refer to “Selecting the input signal” (➔ page 36).
- By default, the time zone of the projector is set to +09:00 (Japan and Korean Standard Time). Change the setting in the [PROJECTOR SETUP] menu → [DATE AND TIME] → [TIME ZONE] to the time zone of the region where you use the projector.

About your projector

Remote control

■ Front

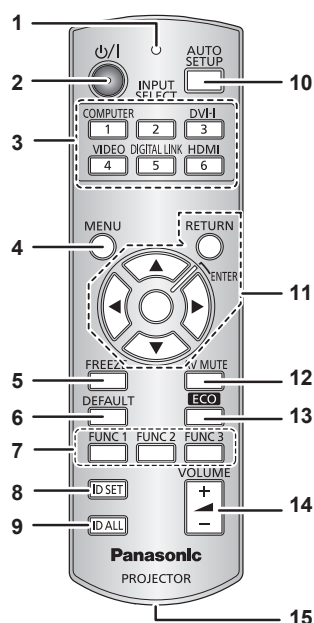

■ Top

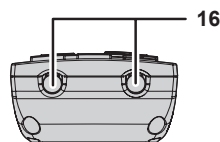

Attach a strap according to usage condition.

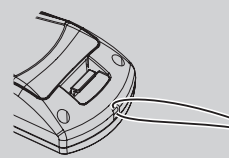

1 Remote control indicator

Flashes if any button in the remote control is pressed.

2 Power <ON/OFF> button

Sets the projector to the standby mode when the <MAIN POWER> switch on the projector is set to <ON>. Also sets the projector in projection mode when the power is switched off (standby mode).

3 Input selection (<COMPUTER>, <DVI-I>, <VIDEO>, <DIGITAL LINK>, <HDMI>) buttons

Switches the input signal to project. (➔ page 39)
Also used to set the ID number of the remote control and security password. (➔ page 23)

4 <MENU> button

Displays the main menu. (➔ page 42)

5 <FREEZE> button

Used to pause a video and mute the audio. (➔ page 38)

6 <DEFAULT> button

Resets the content of the sub-menu to the factory default. (➔ page 43)

7 <FUNC1> to <FUNC3> buttons

You can assign a frequently used operation as a shortcut button. (➔ page 40)

8 <ID SET> button

Sets the ID number of the remote control to use for a system using multiple projectors. (➔ page 23)

9 <ID ALL> button

Use to simultaneously control all the projectors with one remote control for a system using multiple projectors. (➔ page 23)

10 <AUTO SETUP> button

Automatically adjusts the image display position while projecting the image.
[PROGRESS] is displayed on the screen while the image is adjusted automatically. (➔ page 39)

11 ▲▼◀▶ buttons/<RETURN> button/<ENTER> button

Used to navigate through the menu screen.
Also used to enter a [SECURITY] password or character input.

12 <AV MUTE> button

Use to temporarily turn off the audio and video. (➔ page 38)

13 <ECO> button

Displays the setting screen related to ECO management. (➔ page 40)

14 <VOLUME+>/<VOLUME-> button

Adjusts the audio output volume. (➔ page 40)

15 Strap hole

16 Remote control signal transmitter

Attention

- Do not drop the remote control.
- Avoid contact with liquids or moisture.
- Do not attempt to modify or disassemble the remote control.
- When attaching the strap to the remote control, hold the strap to prevent it from swinging.

Note

- The remote control can be used within a distance of about 15 m (49'2") if pointed directly at the remote control receiver. The remote control can control at angles of up to $\pm 15^\circ$ vertically and $\pm 30^\circ$ horizontally, but the effective control range may be reduced.
- If there are any obstacles between the remote control and the remote control signal receiver, the remote control may not operate properly.
- The signal will be reflected off the screen. However, the operating range may be limited from light reflection loss due to the screen material.
- If the remote control signal receiver directly receives strong light, such as fluorescent light, the remote control may not operate properly. Use it in a place distant from the light source.
- The power indicator <ON (G)/STANDBY (R)> will flash if the projector receives a remote control signal.

Projector body

■ Front

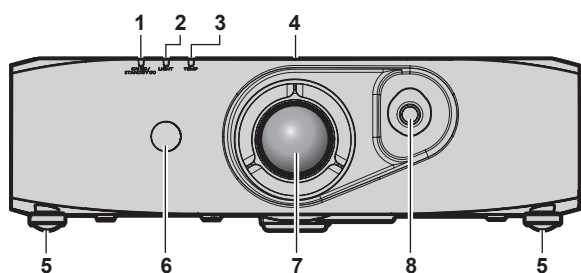

■ Rear

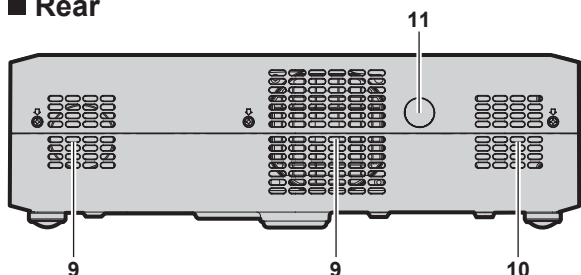

■ Bottom

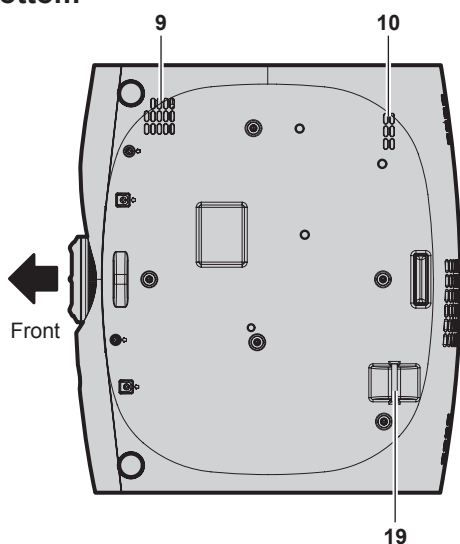

- 1 **Power indicator <ON (G)/STANDBY (R)>**
Displays the status of the power.
- 2 **Light source indicator <LIGHT>**
Displays the status of the light source.
- 3 **Temperature indicator <TEMP>**
Displays the internal temperature status.
- 4 **RISK GROUP 3 label**
The following label is attached to the top surface of the projector.

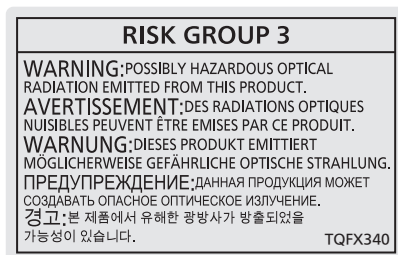

- 5 **Adjustable feet**
Adjusts the projection angle.
- 6 **Remote control signal receiver (front)**
- 7 **Projection lens**

■ Side

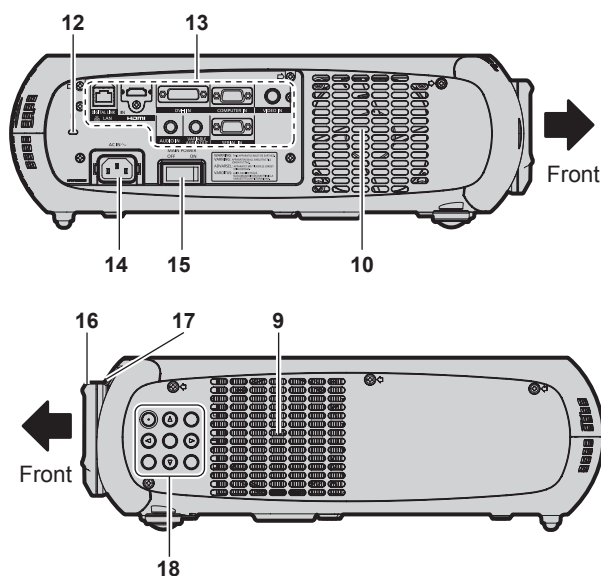

- 8 **Lens shift lever**
Adjusts the projection position.
- 9 **Air intake port**
- 10 **Air exhaust port**
- 11 **Remote control signal receiver (rear)**
- 12 **Security slot**
This security slot is compatible with the Kensington security cables.
- 13 **Connecting terminals (⇒ page 22)**
- 14 **<AC IN> terminal**
Connect the supplied power cord.
- 15 **<MAIN POWER> switch**
Turns on/off the main power.
- 16 **Focus ring**
Adjusts the focus.
- 17 **Zoom ring**
Adjusts the zoom.
- 18 **Control panel (⇒ page 22)**
- 19 **Burglar hook port**
You can attach a commercial burglar prevention cable.

■ Control panel

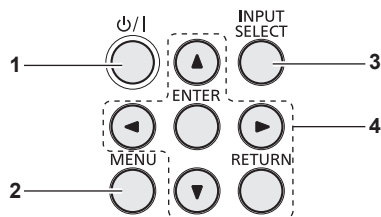

1 Power <⏻/⏻> button

Sets the projector to the state where the projector is switched off (standby mode) when the <MAIN POWER> switch on the projector is set to <ON> and in projection mode. Also sets the projector in projection mode when the power is switched off (standby mode).

2 <MENU> button

Displays the main menu.

3 <INPUT SELECT> button

Switches the input signal to project. (➔ page 39)

4 ▲▼◀▶ buttons/<RETURN> button/<ENTER> button

Used to navigate through the menu screen.

Also used to enter a [SECURITY] password or character input.

■ Connecting terminals

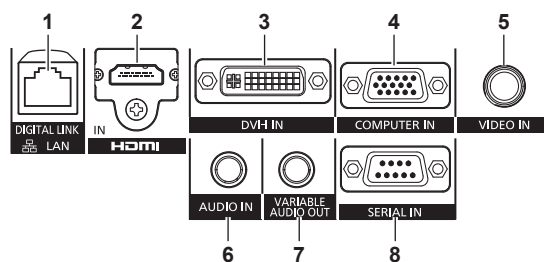

1 <DIGITAL LINK/LAN> terminal

This is the LAN terminal to connect to the network. This is also used when connecting an audio and video signal sending device via the LAN terminal.

2 <HDMI IN> terminal

This is the terminal to input HDMI signals.

3 <DVI-I IN> terminal

This is the terminal to input DVI-D and DVI-A signals (RGB signals or YC_BC_R/YP_BP_R).

4 <COMPUTER IN> terminal

This is the terminal to input RGB or YC_BC_R/YP_BP_R signals from a computer.

5 <VIDEO IN> terminal

This is the terminal to input video signals.

6 <AUDIO IN> terminal

This is the terminal to input audio signals.

7 <VARIABLE AUDIO OUT> terminal

This is the terminal to output audio signals input to the projector.

8 <SERIAL IN> terminal

This is the RS-232C compatible terminal to externally control the projector by connecting a computer.

Attention

- When a LAN cable is directly connected to the projector, the network connection must be made indoors.

Using the remote control

Inserting and removing the batteries

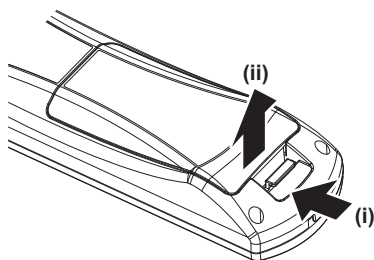

Fig. 1

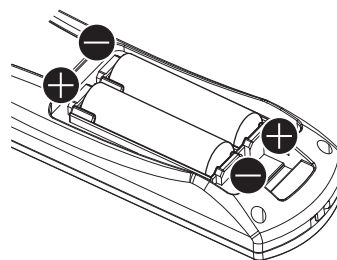

Fig. 2

- 1) Open the cover. (Fig. 1)
- 2) Insert the batteries and close the cover (insert the **−** side first). (Fig. 2)
 - When removing the batteries, perform the steps in reverse order.

Setting the remote control ID numbers

When you use the system with multiple projectors, you can operate all the projectors simultaneously or each projector individually using single remote control, if a unique ID number is assigned to each projector.

After setting the ID number of the projector, set same ID number on the remote control.

The factory default ID number of the projector is set to [ALL]. When using a single projector, press the <ID ALL> button on the remote control. Also, you can control a projector if you press the <ID ALL> button on the remote control even if you do not know the projector ID.

How to set

- 1) Press the <ID SET> button on the remote control.
- 2) Within five seconds, press the one-digit ID number set on the projector using the number (<1> - <6>) buttons.
 - If you press the <ID ALL> button, you can control the projectors regardless of the ID number setting of the projector.

Attention

- Since the ID number of the remote control can be set without the projector, do not press the <ID SET> button carelessly. If the <ID SET> button is pressed and no number (<1> - <6>) buttons are pressed within five seconds, the ID number returns to its original value before the <ID SET> button was pressed.
- The ID number set on the remote control will be stored unless it is set again. However, it will be erased if the remote control is left with dead batteries. Set the same ID number again when the batteries are replaced.

Note

- Set the ID number of the projector from the [PROJECTOR SETUP] menu → [PROJECTOR ID] (➔ page 70).

Chapter 2 **Getting Started**

This chapter describes things you need to do before using the projector such as the setup and connections.

Setting up

Projection method

You can use the projector with any of the following four projection methods. Select the appropriate method depending on the environment.

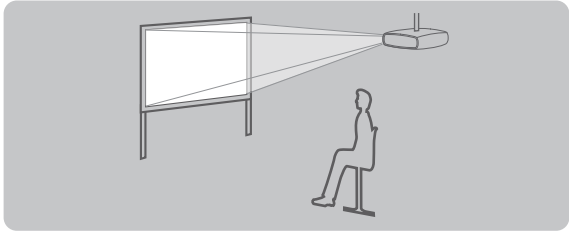
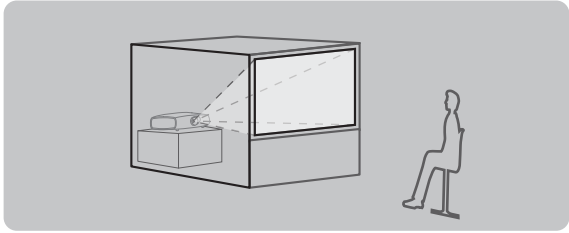
Mounting on the ceiling and projecting forward		Setting on a desk/floor and projecting from rear (Using the translucent screen)	
			
Menu item* ¹	Method	Menu item* ¹	Method
[PROJECTION METHOD]	[FRONT/CEILING]	[PROJECTION METHOD]	[REAR/FLOOR]
[COOLING CONDITION]	[CEILING SETTING]	[COOLING CONDITION]	[FLOOR SETTING]

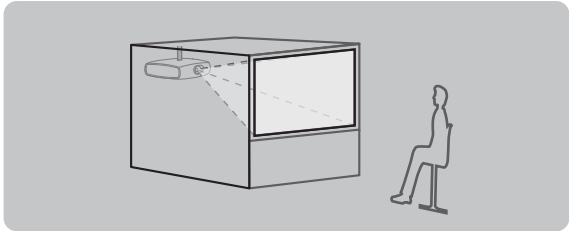
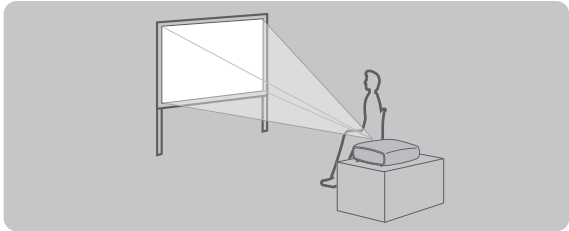
Mounting on the ceiling and projecting from rear (Using the translucent screen)		Setting on a desk/floor and projecting forward	
			
Menu item* ¹	Method	Menu item* ¹	Method
[PROJECTION METHOD]	[REAR/CEILING]	[PROJECTION METHOD]	[FRONT/FLOOR]
[COOLING CONDITION]	[CEILING SETTING]	[COOLING CONDITION]	[FLOOR SETTING]

*1 For menu item details, refer to the [PROJECTOR SETUP] menu → [PROJECTION METHOD] (➔ page 70) and [COOLING CONDITION] (➔ page 71).

Parts for ceiling mount (optional)

You can install the projector on the ceiling using the optional ceiling mount bracket (Model No.: ET-PKR100H (for high ceilings), or ET-PKR100S (for low ceilings).

- Use only the ceiling mount brackets specified for this projector.
- Refer to the installation manual for the ceiling mount bracket when installing and setting up the bracket and the projector.

Attention

- To ensure projector performance and security, installation of the ceiling mount bracket must be carried out by your dealer or a qualified technician.

Screen size and throw distance

Refer to the following figures and table describing projection distances to install the projector. Image size and image position can be adjusted in accordance with the screen size and screen position.

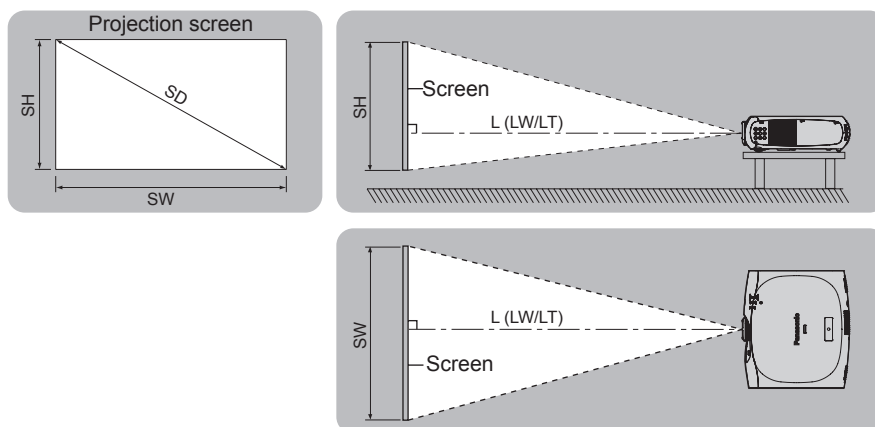

L (LW/LT)*1	Projection distance (m)
SH	Image height (m)
SW	Image width (m)
SD	Image diagonal size (m)

*1 LW: Minimum projection distance
LT: Maximum projection distance

Attention

- Before setting up, read "Precautions for use" (➔ page 14).
- Do not use the projector and the high-powered laser equipment in the same room.
- Hitting of a laser beam on to the lens can damage the DLP chips.

Projection distance

For PT-RZ370EA

(The dimensions of the following table contain a slight error.)

(Unit: m)

Projection screen size	4:3 aspect ratio		16:9 aspect ratio		16:10 aspect ratio	
	Min. projection distance (LW)	Max. projection distance (LT)	Min. projection distance (LW)	Max. projection distance (LT)	Min. projection distance (LW)	Max. projection distance (LT)
1.02 (40")	1.55 (5.10')	3.16 (10.39')	1.26 (4.13')	2.58 (8.47')	1.36 (4.48')	2.79 (9.16')
1.27 (50")	1.95 (6.42')	3.97 (13.02')	1.59 (5.21')	3.23 (10.62')	1.72 (5.65')	3.50 (11.49')
1.52 (60")	2.36 (7.74')	4.77 (15.66')	1.91 (6.29')	3.89 (12.77')	2.07 (6.82')	4.21 (13.81')
1.78 (70")	2.76 (9.06')	5.57 (18.29')	2.24 (7.37')	4.54 (14.92')	2.43 (7.99')	4.92 (16.14')
2.03 (80")	3.16 (10.39')	6.37 (20.92')	2.57 (8.45')	5.20 (17.07')	2.79 (9.15')	5.62 (18.46')
2.29 (90")	3.56 (11.71')	7.18 (23.55')	2.90 (9.53')	5.85 (19.22')	3.14 (10.32')	6.33 (20.79')
2.54 (100")	3.97 (13.03')	7.98 (26.19')	3.23 (10.61')	6.51 (21.37')	3.50 (11.49')	7.04 (23.11')
3.05 (120")	4.77 (15.67')	9.58 (31.45')	3.89 (12.77')	7.82 (25.67')	4.21 (13.82')	8.46 (27.76')
3.81 (150")	5.98 (19.63')	11.99 (39.35')	4.88 (16.01')	9.79 (32.13')	5.28 (17.32')	10.59 (34.74')
5.08 (200")	7.99 (26.24')	16.00 (52.51')	6.52 (21.41')	13.07 (42.88')	7.05 (23.16')	14.13 (46.37')
6.35 (250")	10.01 (32.85')	20.01 (65.67')	8.17 (26.80')	16.34 (53.63')	8.83 (28.99')	17.67 (57.99')
7.62 (300")	12.02 (39.45')	24.03 (78.83')	9.81 (32.20')	19.62 (64.39')	10.61 (34.83')	21.22 (69.62')

For PT-RW330EA

(The dimensions of the following table contain a slight error.)

(Unit: m)

Projection screen size	4:3 aspect ratio		16:9 aspect ratio		16:10 aspect ratio	
	Min. projection distance (LW)	Max. projection distance (LT)	Min. projection distance (LW)	Max. projection distance (LT)	Min. projection distance (LW)	Max. projection distance (LT)
1.02 (40")	1.46 (4.81')	2.99 (9.81')	1.32 (4.53')	2.71 (8.90')	1.29 (4.23')	2.63 (8.65')
1.27 (50")	1.84 (6.06')	3.75 (12.30')	1.67 (5.49')	3.40 (11.15')	1.62 (5.33')	3.30 (10.85')
1.52 (60")	2.22 (7.31')	4.50 (14.79')	2.01 (6.62')	4.08 (13.41')	1.96 (6.43')	3.97 (13.05')
1.78 (70")	2.60 (8.56')	5.26 (17.27')	2.36 (7.75')	4.77 (15.67')	2.29 (7.54')	4.64 (15.24')
2.03 (80")	2.99 (9.81')	6.02 (19.76')	2.71 (8.89')	5.46 (17.93')	2.63 (8.64')	5.31 (17.44')
2.29 (90")	3.37 (11.06')	6.78 (22.25')	3.05 (10.02')	6.15 (20.19')	2.97 (9.74')	5.98 (19.64')
2.54 (100")	3.75 (12.30')	7.54 (24.74')	3.40 (11.15')	6.84 (22.45')	3.30 (10.85')	6.65 (21.83')
3.05 (120")	4.51 (14.80')	9.05 (29.71')	4.09 (13.42')	8.21 (26.96')	3.98 (13.05')	7.99 (26.23')
3.81 (150")	5.65 (18.55')	11.33 (37.18')	5.12 (16.82')	10.28 (33.74')	4.98 (16.36')	10.00 (32.82')
5.08 (200")	7.55 (24.79')	15.12 (49.61')	6.85 (22.49')	13.72 (45.03')	6.66 (21.88')	13.35 (43.81')
6.35 (250")	9.46 (31.03')	18.91 (62.05')	8.58 (28.16')	17.16 (56.32')	8.35 (27.39')	16.70 (54.80')
7.62 (300")	11.36 (37.28')	22.70 (74.49')	10.31 (33.83')	20.61 (67.61')	10.03 (32.91')	20.05 (65.78')

Projection distance formulas

To use a screen size not listed in this manual, check the screen size SD (m) and use the following formula to calculate projection distance. The unit of the formula is m. (The values of the following calculation results contain slight error.)

For PT-RZ370EA

	4:3 aspect ratio	16:9 aspect ratio	16:10 aspect ratio
Screen size Height (SH)	= SD x 0.6	= SD x 0.490	= SD x 0.530
Screen size Width (SW)	= SD x 0.8	= SD x 0.872	= SD x 0.848
Min. projection distance (LW)	= 1.5854 x SD - 0.0544	= 1.2955 x SD - 0.0544	= 1.4004 x SD - 0.0544
Max. projection distance (LT)	= 3.1589 x SD - 0.0408	= 2.5812 x SD - 0.0408	= 2.7904 x SD - 0.0408

For PT-RW330EA

	4:3 aspect ratio	16:9 aspect ratio	16:10 aspect ratio
Screen size Height (SH)	= SD x 0.6	= SD x 0.490	= SD x 0.530
Screen size Width (SW)	= SD x 0.8	= SD x 0.872	= SD x 0.848
Min. projection distance (LW)	= 1.4984 x SD - 0.0542	= 1.3604 x SD - 0.0542	= 1.3236 x SD - 0.0542
Max. projection distance (LT)	= 2.9851 x SD - 0.0407	= 2.7102 x SD - 0.0407	= 2.6369 x SD - 0.0407

Adjusting adjustable feet

Install the projector on a flat surface so that the front of the projector is parallel to the screen surface and the projection screen is rectangular. If the screen is tilted downward, the projection screen can be adjusted to be rectangular by adjusting the adjustable feet. The adjustable feet can also be used to adjust the projector to be level when it is tilted in a horizontal direction.

Extend the adjustable feet by rotating in the direction shown in the figure and retract by rotating in the opposite direction.

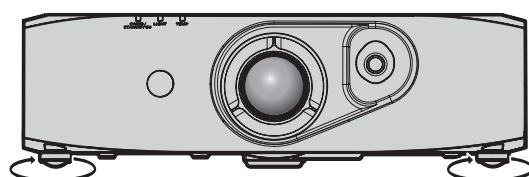

Adjustable amount

Front adjustable feet: Approx. 12 mm (15/32")

Attention

- When adjusting the adjustable feet when the light source is on, make sure that your hands do not block the intake and exhaust. (➔ page 21)
- When there is trapezoidal distortion, execute the [POSITION] menu → [KEYSTONE] (➔ page 55).

Connecting

Before connecting

- Before connecting, carefully read the operating instructions for the external device to be connected.
- Turn off the power of all devices before connecting cables.
- Take note of the following points before connecting the cables. Failure to do so may result in malfunctions.
 - When connecting a cable to a device connected to the projector or the projector itself, touch any nearby metallic objects to eliminate static electricity from your body before performing work.
 - Do not use unnecessarily long cables to connect to a device connected to the projector or to the projector body. The longer the cable, the more it is susceptible to noise. Since using a cable while it is wound makes it act like an antenna, it is more susceptible to noise.
 - When connecting cables, connect GND first, then insert the connecting terminal of the connecting device in a straight manner.
- Acquire any connection cable necessary to connect the external device to the system that is either not supplied with the device or not available as an option.
- Video signals containing too much jitter may cause the images on the screen to randomly wobble or wafture. In this case, a time base corrector (TBC) must be connected.
- The projector accepts video signals, analog RGB signals (synchronous signals are TTL level), and digital signals.
- Some computer models are not compatible with the projector.
- Use a cable compensator when you connect devices to the projector using long cables. Otherwise the image may not display properly.
- Refer to “List of compatible signals” (➔ page 122) for the types of video signals that can be used with the projector.

<COMPUTER IN> terminal pin assignments and signal names

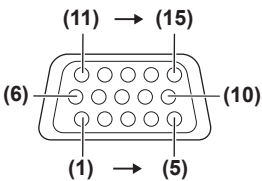
Outside view	Pin No.	Signal name	Pin No.	Signal name
	(1)	R/P _R	(9)	—
	(2)	G/Y	(10)	GND
	(3)	B/P _B	(11)	GND
	(4)	—	(12)	DDC data
	(5)	GND	(13)	SYNC/HD
	(6)	GND	(14)	VD
	(7)	GND	(15)	DDC clock
	(8)	GND		

<DVI-I IN> terminal pin assignments and signal names

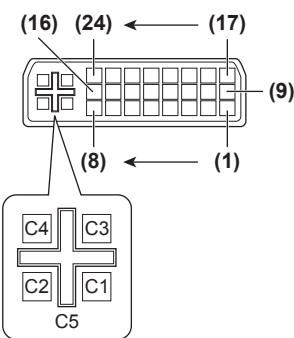
Outside view	Pin No.	Signal name	Pin No.	Signal name
	(1)	T.M.D.S data 2-	(16)	Hot plug detection
	(2)	T.M.D.S data 2+	(17)	T.M.D.S data 0-
	(3)	T.M.D.S data 2/4 shield	(18)	T.M.D.S data 0+
	(4)	—	(19)	T.M.D.S data 0/5 shield
	(5)	—	(20)	—
	(6)	DDC clock	(21)	—
	(7)	DDC data	(22)	T.M.D.S clock shield
	(8)	Analog VD	(23)	T.M.D.S clock+
	(9)	T.M.D.S data 1-	(24)	T.M.D.S clock-
	(10)	T.M.D.S data 1+	C1	Analog R/P _R
	(11)	T.M.D.S data 1/3 shield	C2	Analog G/G SYNC/Y
	(12)	—	C3	Analog B/P _B
	(13)	—	C4	Analog HD/SYNC
	(14)	+5 V	C5	Analog GND
	(15)	GND		

<HDMI IN> terminal pin assignments and signal names

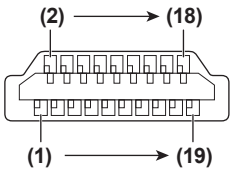
Outside view	Pin No.	Signal name	Pin No.	Signal name
Even-numbered pins (2) to (18)  Odd-numbered pins (1) to (19)	(1)	T.M.D.S data 2+	(11)	T.M.D.S clock shield
	(2)	T.M.D.S data 2 shield	(12)	T.M.D.S clock-
	(3)	T.M.D.S data 2-	(13)	CEC
	(4)	T.M.D.S data 1+	(14)	—
	(5)	T.M.D.S data 1 shield	(15)	SCL
	(6)	T.M.D.S data 1-	(16)	SDA
	(7)	T.M.D.S data 0+	(17)	DDC/CEC GND
	(8)	T.M.D.S data 0 shield	(18)	+5 V
	(9)	T.M.D.S data 0-	(19)	Hot plug detection
	(10)	T.M.D.S clock+		

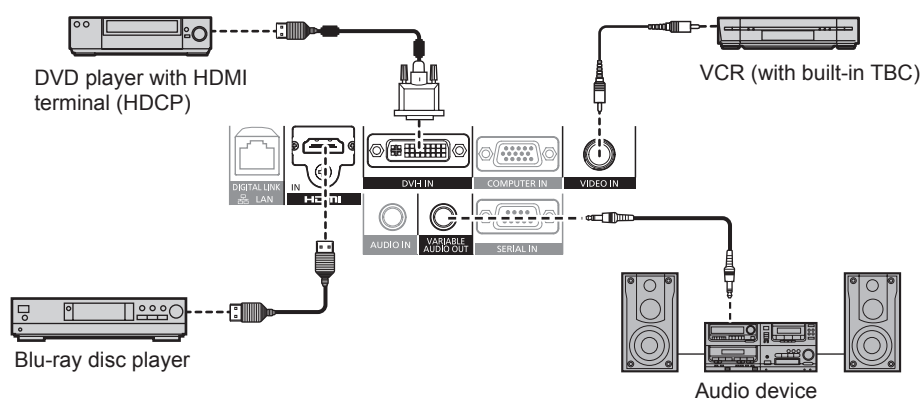
Connecting example: AV equipment

Attention

- Always use one of the following when connecting a VCR.
 - A VCR with built-in time base corrector (TBC)
 - A time base corrector (TBC) between the projector and the VCR
- If nonstandard burst signals are connected, the image may be distorted. In such case, connect the time base corrector (TBC) between the projector.
- Use a commercial HDMI/DVI conversion cable with a ferrite core.

Note

- The <DVI-I IN> terminal can be connected to HDMI- or DVI-I-compliant devices. However, images may not appear or may not be displayed properly on some devices. (➔ page 63)
- For an HDMI cable, use an HDMI High Speed cable that conforms to HDMI standards. If a cable that does not conform to HDMI standards is used, images may be interrupted or not displayed, or the projector may not function properly.
- The <HDMI IN> terminal of the projector can be connected to an external device with an DVI terminal by using an HDMI/DVI conversion cable, but some devices may not project the image properly or function properly. (➔ page 64)
- When DVI-I is input, some external devices to be connected may require EDID to be set. (➔ page 63)
- The projector does not support VIERA Link (HDMI).
- If the [AUDIO IN SELECT] settings are incorrect, the projector may not output audio or otherwise function properly. (➔ page 79)

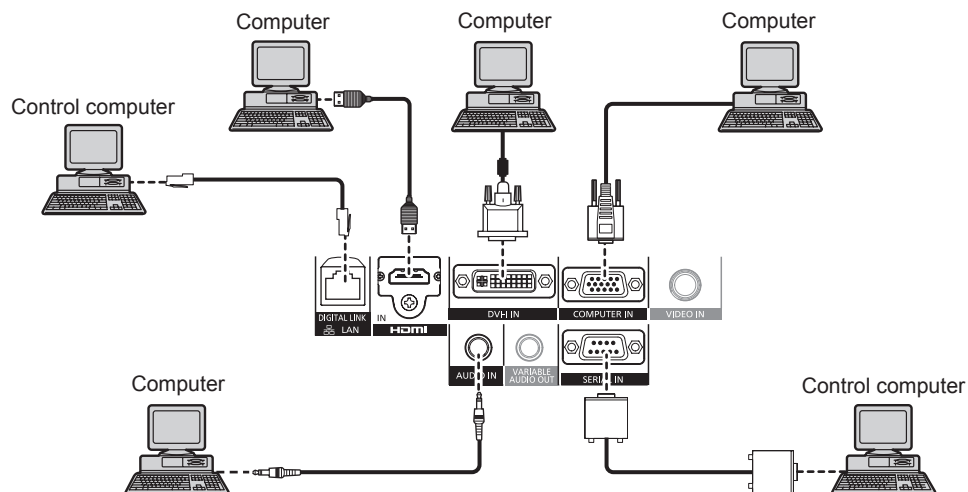
Connecting example: Computers



Attention

- When connecting the projector to a computer or an external device, use the power cord supplied with each device and commercially available shielded cables.
- Use a commercial DVI-D cable with a ferrite core.

Note

- For an HDMI cable, use an HDMI High Speed cable that conforms to HDMI standards. If a cable that does not conform to HDMI standards is used, images may be interrupted or not displayed, or the projector may not function properly.
- The <HDMI IN> terminal of the projector can be connected to an external device with a DVI terminal by using an HDMI/DVI conversion cable, but some devices may not project the image properly or otherwise function properly. (➔ page 64)
- The <DVI-I IN> terminal (for digital input) supports single link only.
- For signals that the projector can project, refer to “List of compatible signals” (➔ page 122).
- If you operate the projector using the computer with the resume feature (last memory), you may have to reset the resume feature to operate the projector.
- During DVI digital signal input, EDID settings may be necessary depending on the external devices to be connected. (➔ page 63)
- If the [AUDIO IN SELECT] settings are incorrect, the projector may not output audio or otherwise function properly. (➔ page 79)

Connecting example: Twisted-pair-cable transmitter

Twisted-pair-cable transmitters such as the optional digital interface box (Model No.: ET-YFB100G) use twisted-pair-cables to transmit input video, audio, Ethernet, and serial signals, and the projector can input those digital signals to the <DIGITAL LINK/LAN> terminal.

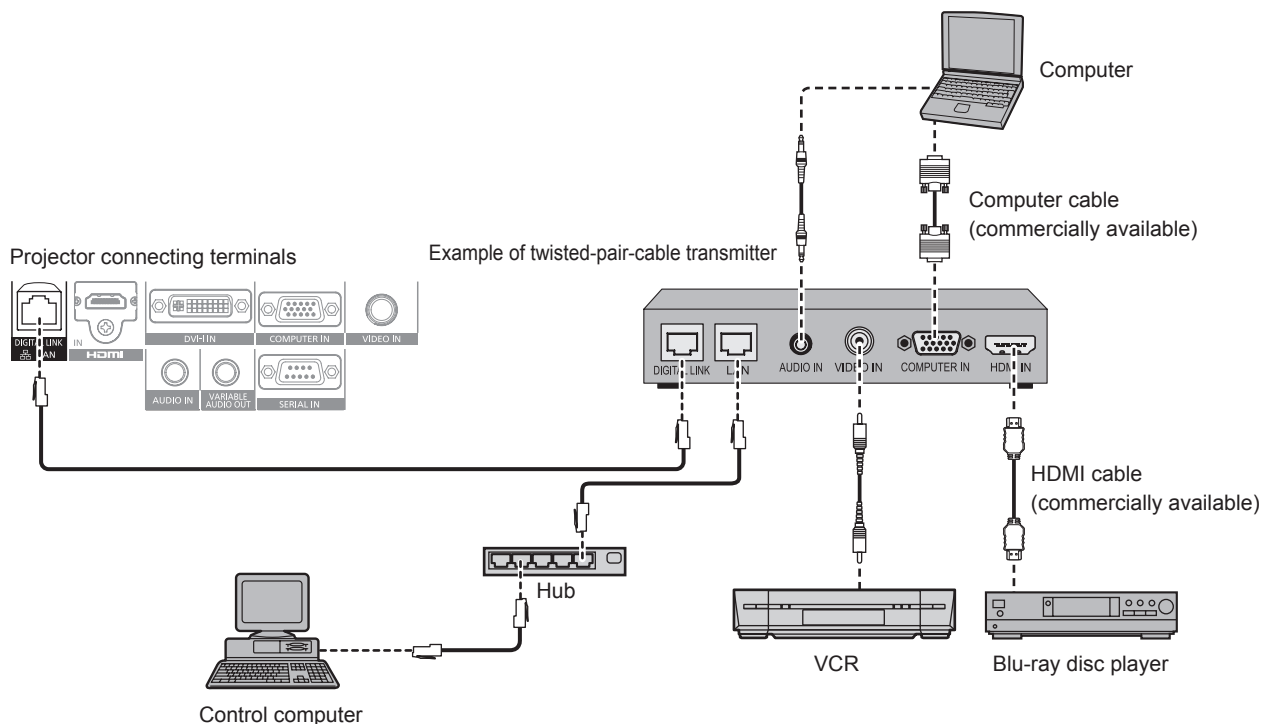

Attention

- Always use one of the following when connecting a VCR.
 - A VCR with built-in time base corrector (TBC)
 - A time base corrector (TBC) between the projector and the VCR
- If nonstandard burst signals are connected, the image may be distorted. In such case, connect the time base corrector (TBC) between the projector.
- Use a commercial HDMI/DVI conversion cable with a ferrite core.
- Ask a qualified technician or your dealer to install the cable wiring for a twisted-pair-cable transmitter and the projector connection. Image and sound may be disrupted if cable transmission characteristics can not be obtained due to inadequate installation.
- For the LAN cable between a twisted-pair-cable transmitter and the projector, use a cable that meets the following criteria:
 - Compatible with CAT5e or higher
 - Shielded type (including connectors)
 - Straight-through
 - Single wire
- When laying cables between a twisted-pair-cable transmitter and the projector, check that cable characteristics are compatible with CAT5e or higher using tools such as a cable tester or cable analyzer.
When using a relay connector midway, include it in the measurement.
- Do not use a hub between a twisted-pair-cable transmitter and the projector.
- When connecting to the projector using a twisted-pair-cable transmitter (receiver) of other company, do not place another twisted-pair-cable transmitter in between the twisted-pair-cable transmitter of other company and the projector. This may cause sound and image to be disrupted.
- Do not pull cables forcefully. Also, do not bend or fold cables unnecessarily.
- To reduce noise, stretch out the cables between the twisted-pair-cable transmitter and the projector without any loops as much as possible before setting them up and using them.
- Lay the cables between a twisted-pair cable transmitter and the projector away from other cables, particularly power cables.
- When installing multiple cables, run them side by side along the shortest distance possible without bundling them together.
- After laying the cables, confirm that the [SIGNAL QUALITY] value is displayed in green to indicate normal quality using the [NETWORK] menu → [DIGITAL LINK STATUS]. (➡ page 90)

Note

- For an HDMI cable, use an HDMI High Speed cable that conforms to HDMI standards. If a cable that does not conform to HDMI standards is used, images may be interrupted or may not be displayed.
- The projector does not support VIERA Link (HDMI).
- The maximum transmission distance between the twisted-pair-cable transmitter and the projector is 100 m (328'1"). If this distance is exceeded, image and sound may be disrupted and may cause a malfunction in LAN communication. Please note that we do not support the use of the projector outside the maximum transmission distance.
- For twisted-pair-cable transmitter of other manufacturers of which the operation has been verified with the DIGITAL LINK compatible projector, refer to Panasonic website (<http://panasonic.net/avc/projector/>). Note that the verification for devices of other manufacturers has been made for the items set by Panasonic Corporation, and not all the operations have been verified. For operation or performance problems caused by the devices of other manufacturers, contact the respective manufacturers.

Chapter 3 Basic Operations

This chapter describes basic operations to start with.

Switching on/off the projector

Connecting the power cord

Make sure that the supplied power cord is securely fixed to the projector body to prevent it from being removed easily.

Confirm that the <MAIN POWER> switch is on the <OFF> side before connecting the power cord.

For details of power cord handling, refer to “Read this first!” (➔ page 2).

Attaching the power cord

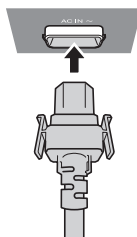

- 1) Check the shapes of the <AC IN> terminal on the side of the projector body and the power cord connector and insert the plug completely in the correct direction until you hear the hooks click in place.

Removing the power cord

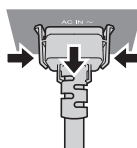

- 1) Confirm that the <MAIN POWER> switch of the main side is on the <OFF> side, and remove the power plug from the outlet.
- 2) Remove the power cord connector from the <AC IN> terminal of the projector body while pressing the side tabs.

Power indicator

Displays the status of the power. Check the <ON (G)/STANDBY (R)> status of the power indicator before operating the projector.

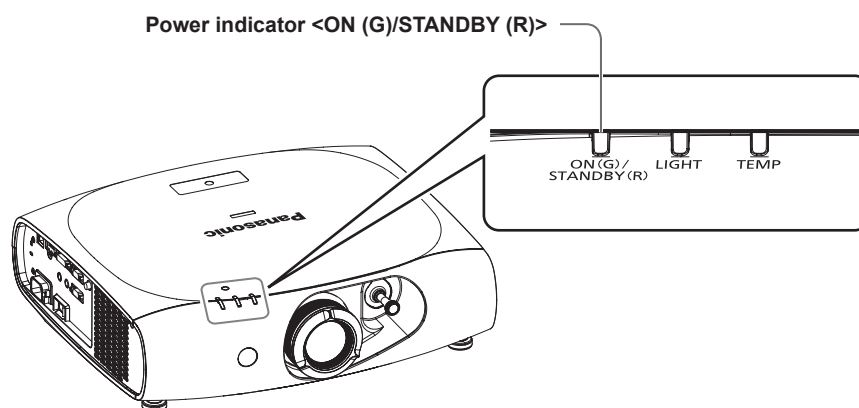

Indicator status		Status
Off		The main power is switched off.
Red	Flashing	The power is switched off (in standby mode). [STANDBY MODE] is set to [NORMAL]. Projection will start when the power <ϕ/ > button is pressed. • The projector may not operate when the temperature indicator <TEMP> is flashing. (➔ page 110)
	Lit	The power is switched off (in standby mode). [STANDBY MODE] is set to [ECO]. Projection will start when the power <ϕ/ > button is pressed. • The projector may not operate when the temperature indicator <TEMP> is flashing. (➔ page 110)
Green	Lit	Projecting.

Note

- The projector consumes power even in standby mode (the power indicator <ON (G)/STANDBY (R)> lights/flashs in red). Refer to “Power consumption” (➔ page 124) for the power consumption.
- The power indicator <ON (G)/STANDBY (R)> flashes in green if a remote control signal is received.
- The power indicator <ON (G)/STANDBY (R)> flashes in green slowly when the projector is in AV mute mode.

Switching on the projector

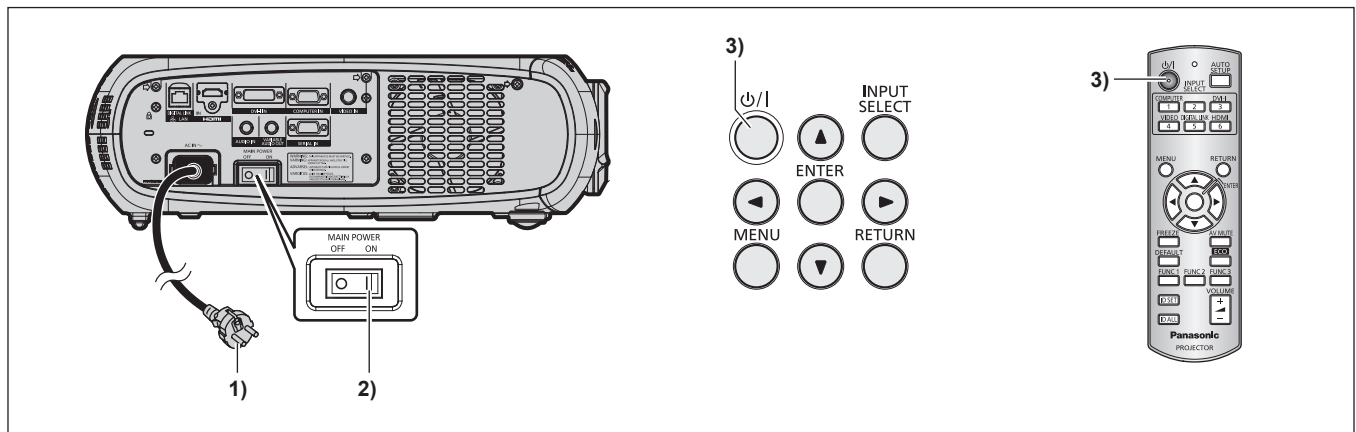

1) Connect the power plug to an outlet.

- (AC 100 V - 240 V 50 Hz/60 Hz)

2) Press the <ON> side of the <MAIN POWER> switch to turn on the power.

- The power indicator <ON (G)/STANDBY (R)> lights/flashs in red, and the projector enters the standby mode.

3) Press the power <ϕ/|> button.

- The power indicator <ON (G)/STANDBY (R)> lights in green and the image is soon projected on the screen.

Note

- If the projector is switched on at around 0 °C (32 °F), a warm-up period of approximately five minutes may be necessary until an image is displayed. The temperature indicator <TEMP> lights during the warm-up period. When the warm-up is completed, the temperature indicator <TEMP> turns off and the projection starts. Refer to “Managing the indicated problems” (➔ page 110) for the indicator status.
- If the operating environment temperature is low and warm-up takes more than five minutes, the projector will judge that a problem has occurred and the power will automatically be set to standby mode. If this happens, increase the operating environment temperature to 0 °C (32 °F) or higher, turn off the main power, and then turn on the power again.
- If the [PROJECTOR SETUP] menu → [ECO MANAGEMENT] → [STANDBY MODE] (➔ page 73) is set to [ECO], there may be a delay in displaying when the power is turned on compared to when the setting is [NORMAL].
- When the power is turned on or an input signal is switched, you may here a high-frequency driving sound. This is not a malfunction.
- If the [PROJECTOR SETUP] menu → [INITIAL STARTUP] (➔ page 75) is set to [LAST MEMORY] and the power is turned off by pressing the <OFF> side of the <MAIN POWER> switch or by using the breaker directly while projecting at the last time of use, the power indicator <ON (G)/STANDBY (R)> lights in green and projection starts after a while when the power is turned on by pressing the <ON> side of the <MAIN POWER> switch with the power plug connected to the outlet, or when the breaker is turned on.

Making adjustments and selections

It is recommended that images are projected continuously for at least 30 minutes before the focus is adjusted.

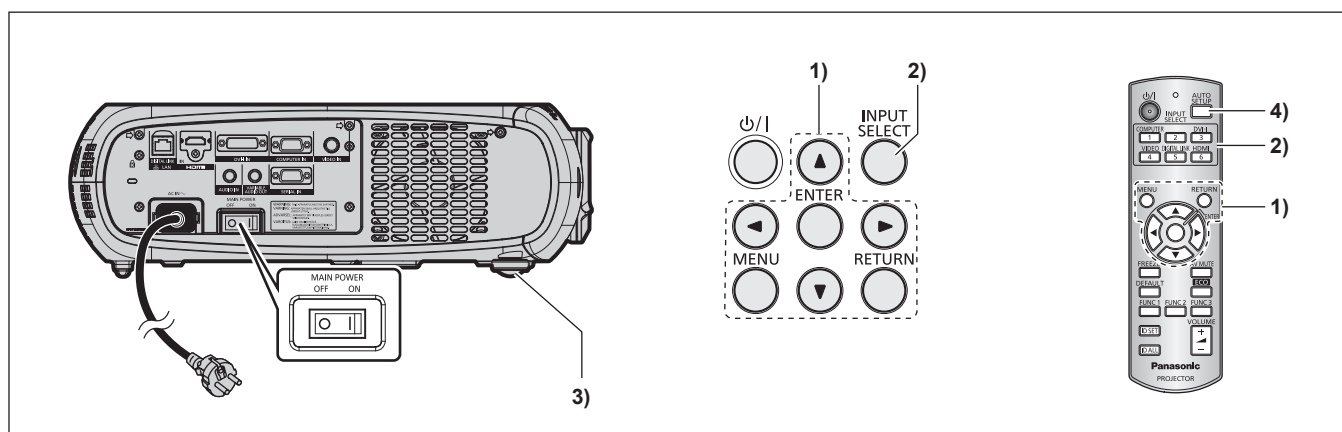

1) Set the initial settings. (➔ page 19)

- The initial setting screen is displayed when the projector is switched on for the first time after purchase as well as when [ALL USER DATA] (➔ page 82) in [INITIALIZE] is executed.

2) Press the input selection (<COMPUTER>, <DVI-I>, <VIDEO>, <DIGITAL LINK>, <HDMI>) buttons to select the input signal. (➔ page 39)

3) Adjust the front, back and sideways tilt of the projector with the adjustable feet. (➔ page 27)

4) If the input signal is an RGB input signal, press the <AUTO SETUP> button. (➔ page 39)

Switching off the projector

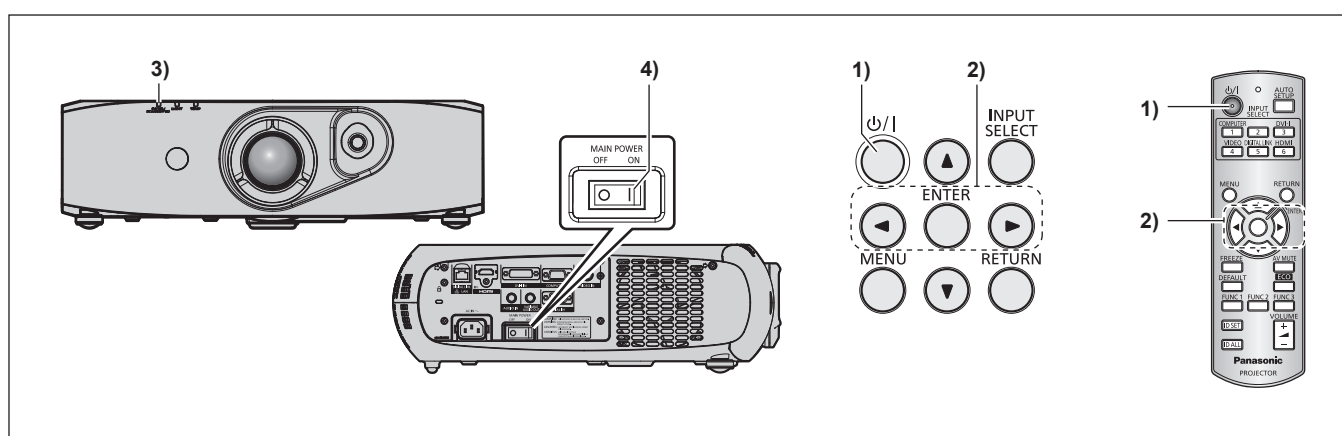

1) Press the power <⏻/|> button.

- The [POWER OFF(STANDBY)] confirmation screen is displayed.

2) Press ◀▶ to select [OK], and press the <ENTER> button. (Or press the power <⏻/|> button again.)

- Projection of the image stops.

3) Wait for a few seconds until the power indicator <ON (G)/STANDBY (R)> of the projector body lights/ flashes in red.

4) Press the <OFF> side of the <MAIN POWER> switch to turn off the power.

Note

- The projector consumes power if the main power of the projector is on, even when the power <⏻/|> button is pressed and the power is switched off.
When the [STANDBY MODE] menu (➔ page 73) is set to [ECO], the power consumption during standby can be conserved.
- The power can be turned off by pressing the <OFF> side of the <MAIN POWER> switch while projecting or by directly using the breaker under conditions where the <MAIN POWER> switch of the projector cannot be switched off/on easily such as while mounting on the ceiling. However, the settings or adjustments performed right before the power is turned off may not be reflected.

Projecting

Check the external device connections (➔ page 28) and the power cord connection (➔ page 33), and turn on the projector (➔ page 34) to start projecting. Select the video for projection, and adjust appearance of the projected image.

Selecting the input signal

Select an input signal.

1) Press the input selection (<COMPUTER>, <DVI-I>, <VIDEO>, <DIGITAL LINK>, <HDMI>) buttons on the remote control or the <INPUT SELECT> button on the control panel.

- The image of the signal being input in the selected terminal is projected.

Attention

- Images may not be projected properly depending on the external device, or the blu-ray disc or DVD disc, to be played back. Set the [PICTURE] menu → [SYSTEM SELECTOR] (➔ page 51).
- Confirm the aspect ratio of the projection screen and the image, and switch to an optimum aspect ratio from the [POSITION] menu → [ASPECT] (➔ page 53).

Adjusting the image

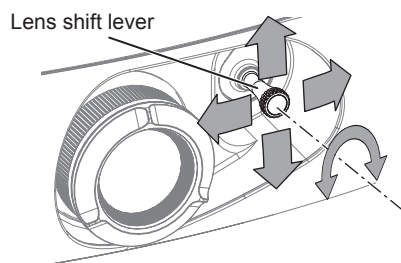

Fig. 1

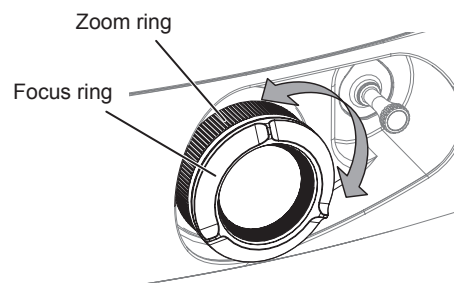

Fig. 2

1) Adjust the projection angle.

- Place the projector parallel to the screen and install on a flat surface so that the projection screen is rectangular.
- If the projector is tilted further downward than the screen, adjust the projection screen to be rectangular by extending the adjustable feet.
- Refer to “Adjusting adjustable feet” (➔ page 27) for details.

2) Release the lens shift lever lock by turning it counter-clockwise.

3) Adjust the lens shift. (Fig. 1)

- Adjust the projection position using the lens shift lever.
- Refer to “Adjustment range by the lens position shift (optical shift)” (➔ page 37) for details.

4) Lock the lens shift lever by turning it clockwise.

5) Adjust the zoom and focus. (Fig. 2)

- Adjust by turning the zoom ring and focus ring.

Attention

- Note that your fingers may get caught between the lens and surrounding area when adjusting the zoom, depending on the position of the hand holding the zoom ring.

Note

- It is recommended that images are projected continuously for at least 30 minutes before the focus is adjusted.
- Turning the focus ring changes the projection screen size. Make fine adjustments again to the projection screen size by turning the zoom ring.
- When there is trapezoidal distortion, execute the [POSITION] menu → [KEYSTONE] (➔ page 55).

Adjustment range by the lens position shift (optical shift)

Perform the lens position shift within the adjustment range.

The focus may change when the lens position is shifted out of the adjustment range. This is because the movement of the lens is restricted to protect the optical parts. Projection position can be adjusted with the optical axis shift based on the standard projection position in the range shown in the following figures.

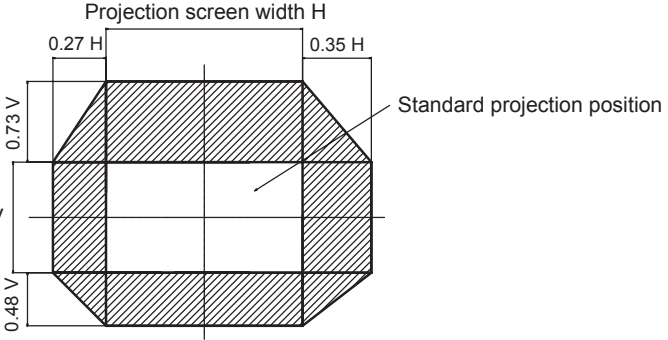
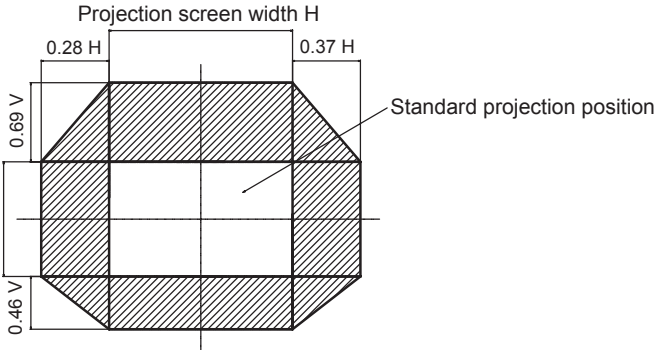
PT-RZ370EA	 <p>The diagram for PT-RZ370EA shows a projection screen with width H and height V. A central area is labeled 'Standard projection position'. The adjustment range is indicated by a shaded area. The horizontal dimensions are 0.27 H on the left and 0.35 H on the right. The vertical dimensions are 0.73 V on the top and 0.48 V on the bottom.</p>
PT-RW330EA	 <p>The diagram for PT-RW330EA shows a projection screen with width H and height V. A central area is labeled 'Standard projection position'. The adjustment range is indicated by a shaded area. The horizontal dimensions are 0.28 H on the left and 0.37 H on the right. The vertical dimensions are 0.69 V on the top and 0.46 V on the bottom.</p>

* The numerical values in the preceding diagrams represent a case in which the projector is set on a desk/floor.

Note

- Set up the projector in front of the screen and adjust the lens shift lever to the center to obtain the optimal screen.

Operating with the remote control

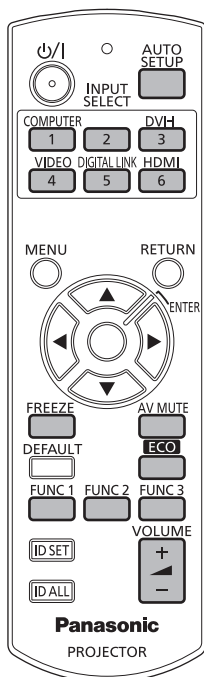

Using the AV mute function

If the projector is not used for a certain period of time during the meeting intermission, for example, it is possible to turn off the audio and video temporarily.

AV MUTE



button

1) Press the <AV MUTE> button.

- The audio and video disappears.

2) Press the <AV MUTE> button again.

- There is audio and video.

Note

- The power indicator <ON (G)/STANDBY (R)> flashes slowly when the projector is in AV mute mode.
- The projector has no built-in speakers. There is audio output from the external sound system connected to the <VARIABLE AUDIO OUT> terminal.

Using the Freeze function

The projected image can be paused temporarily and the audio muted, regardless of the playback of the external equipment.

FREEZE



button

1) Press the <FREEZE> button.

- The video pauses and the audio is muted.

2) Press the <FREEZE> button again.

- Video playback resumes and audio is unmuted.

Note

- [FREEZE] is displayed on the screen when video is paused.

Switching the input

The input for projection can be switched.

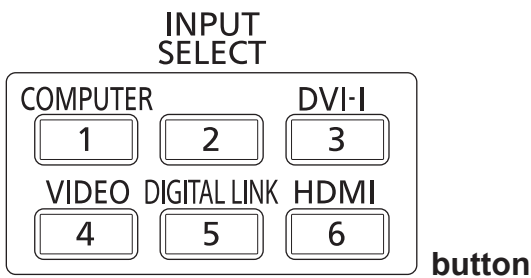

1) Press the input selection (<COMPUTER>, <DVI-I>, <VIDEO>, <DIGITAL LINK>, <HDMI>) buttons.

- This operation can be also performed using the <INPUT SELECT> button on the control panel.

<COMPUTER>	Switches to COMPUTER input.
<DVI-I>	Switches to DVI-I input.
<VIDEO>	Switches to VIDEO input.
<DIGITAL LINK>	Switches to DIGITAL LINK input.
<HDMI>	Switches to HDMI input.

Note

- When the optional digital interface box (Model No.: ET-YFB100G) is connected to the <DIGITAL LINK/LAN> terminal, the ET-YFB100G input changes with each press of the <DIGITAL LINK> button.
For twisted-pair-cable transmitters of other companies, switch the input on the twisted-pair-cable transmitter after switching to DIGITAL LINK input.

Using the Automatic setup function

The automatic setup function can be used to automatically adjust the resolution, clock phase, and image position when analog RGB signals consisting of bitmap images such as computer signals are being input, or to automatically adjust the image position when DVI-D/HDMI signals are input. Supplying images with bright white borders at the edges and high-contrast black and white characters is recommended when the system is in automatic adjustment mode.

Avoid supplying images that include halftones or gradation, such as photographs and computer graphics.



1) Press the <AUTO SETUP> button.

- [COMPLETE] is displayed when it has completed without any problem.

Note

- The clock phase may shift even if it has completed without any incident. In this case, adjust with the [POSITION] menu → [CLOCK PHASE] (➡ page 54).
- If an image with blurred edges or a dark image is input, [INCOMPLETE] may appear or adjustment may not be performed properly even when [COMPLETE] appears. In this case, adjust the settings in the [ADVANCED MENU] menu → [INPUT RESOLUTION] (➡ page 57), [POSITION] → [CLOCK PHASE] (➡ page 54), [SHIFT] (➡ page 52).
- Adjust special signals according to the [DISPLAY OPTION] menu → [AUTO SETUP] (➡ page 62).
- Automatic adjustment may not work depending on the model of the computer.
- Automatic adjustment may not work for a synchronization signal of C-SY or SYNC ON GREEN.
- Images may be disrupted for a few seconds during automatic adjustment, but it is not a malfunction.
- Adjustment is required for each input signal.
- Automatic adjustment can be canceled by pressing the <RETURN> button or the <MENU> button during the automatic adjustment operation.
- If the automatic setup function is performed while moving images are being input, the adjustment may not be performed properly even for an RGB signal for which automatic setup can be used. [INCOMPLETE] may appear, or adjustment may not be finished properly even if [COMPLETE] appears.

Using the Function button

Frequently used operations can be assigned to the buttons from <FUNC1> to <FUNC3> on the remote control to be used as simple shortcut buttons.



- 1) Press the <FUNC1> to <FUNC3> buttons.

When assigning operations to the buttons from <FUNC1> to <FUNC3>

- 1) Press the <MENU> on the control panel or the remote control to display the menu items (main menu, sub-menu, or details menu) you want to assign.
 - Refer to “Navigating through the menu” (➔ page 42) for the operation of the on-screen menu.
- 2) Press and hold any buttons from <FUNC1> to <FUNC3> for three seconds or more.

Note

- When settings are completed, F1, F2, or F3 is displayed on the left of the menu item (main menu, sub-menu, or details menu) assigned when <FUNC1>, <FUNC2>, or <FUNC3> is set, respectively.
- To clear the assigned functions, perform the [PROJECTOR SETUP] menu → [FUNCTION BUTTON] (➔ page 78).

Using the ECO management function

The setting screen related to the ECO management can be displayed.



- 1) Press the <ECO> button on the remote control.

Note

- Refer to the [PROJECTOR SETUP] menu → [ECO MANAGEMENT] (➔ page 71) for details.

Adjusting the volume

The audio output volume can be adjusted.

VOLUME

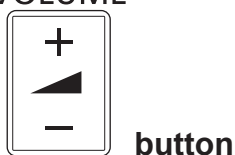

- 1) Press the <VOLUME+>/<VOLUME-> button on the remote control.

<VOLUME+>	Increases the volume.
<VOLUME->	Decreases the volume.

Chapter 4 Settings

This chapter describes the settings and adjustments you can make using the on-screen menu.

Menu navigation

The on-screen menu (Menu) is used to perform various settings and adjustments of the projector.

Navigating through the menu

Operating procedure

MENU



1) Press the <MENU> button on the remote control or control panel.

- The [MAIN MENU] screen is displayed.

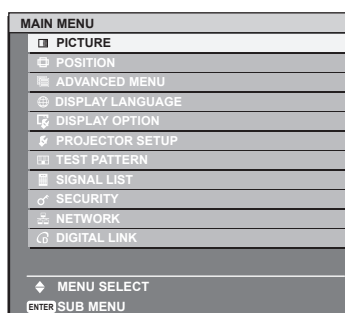

2) Press ▲▼ to select an item from the main menu.

- The selected item is highlighted in yellow.

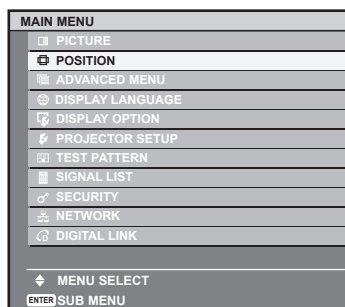

3) Press the <ENTER> button.

- The sub-menu items of the selected main menu are displayed.

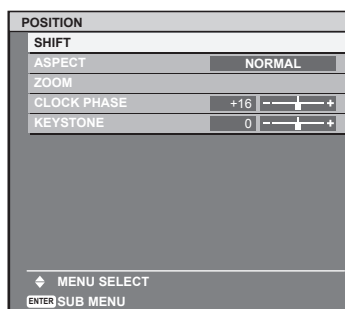

4) Press ▲▼ to select a sub-menu, and press ◀▶ or the <ENTER> button to change or adjust settings.

- Menu items switch in order as follows each time you press ◀▶.

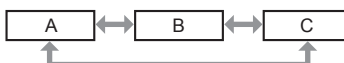

- For some items, press ◀▶ to display an individual adjustment screen with a bar scale as shown below.



Note

- Pressing the <RETURN> button or the <MENU> button when the menu screen is displayed returns to the previous menu.
- Some items may not be adjusted or used for certain signal formats to be input to the projector. The menu items that cannot be adjusted or used are shown in gray characters, and they cannot be selected.
- Some items can be adjusted even if signals are not input.
- Individual adjustment screen is cleared automatically if no operation is performed for approximately five seconds.
- For menu items, refer to “Main menu” (➔ page 43) and “Sub-menu” (➔ page 44).
- The cursor color depends on the settings of the [OSD DESIGN] menu (➔ page 65). The selected item is displayed with the yellow cursor by default.

Resetting adjustment values to the factory default

If the <DEFAULT> button on the remote control is pressed, the values adjusted in the menu items are restored to the factory default settings.

DEFAULT



button

1) Press the <DEFAULT> button on the remote control.



Note

- You cannot reset all the settings to the factory default at a time.
- To reset all the settings adjusted in the sub-menu item to the factory default at a time, execute the [PROJECTOR SETUP] menu → [INITIALIZE] (➔ page 82).
- Some items cannot be reset by pressing the <DEFAULT> button. Adjust each item manually.
- The square mark under the bar scale in the individual adjustment screen indicates the factory default setting. The position of the square mark varies by the selected input signals.

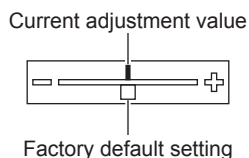

Setting the on-screen display to show/hide

If you press the <MENU> button on the control panel or the remote control for at least three seconds, the on-screen display setup screen is displayed and the on-screen display can be set to show/hide.

Note





- If the [SECURITY] menu → [TEXT DISPLAY] is [ON], the on-screen setting screen cannot be displayed.

Main menu

The main menu consists of the following 11 items.

When a main menu item is selected, the screen changes to a sub-menu selection screen.

Main menu item		Page
	[PICTURE]	47
	[POSITION]	52
	[ADVANCED MENU]	56
	[DISPLAY LANGUAGE]	59
	[DISPLAY OPTION]	60
	[PROJECTOR SETUP]	70

Main menu item		Page
	[TEST PATTERN]	83
	[SIGNAL LIST]	84
	[SECURITY]	86
	[NETWORK]	89
	[DIGITAL LINK]	108

Sub-menu

The sub-menu of the selected main menu item is displayed, and you can set and adjust items in the sub-menu.

[PICTURE]

Sub-menu item	Factory default	Page
[PICTURE MODE]	[GRAPHIC] ^{*1}	47
[CONTRAST]	[0]	47
[BRIGHTNESS]	[0]	48
[COLOR]	[0]	48
[TINT]	[0]	48
[COLOR TEMPERATURE]	[DEFAULT]	48
[DAYLIGHT VIEW]	[AUTO]	50
[SHARPNESS]	[6] ^{*1}	50
[NOISE REDUCTION]	[OFF] ^{*1}	50
[SYSTEM SELECTOR]	[YPbPr] ^{*1}	51

*1 Depends on the signal input.

Note

- The factory default settings may vary depending on the picture mode.

[POSITION]

Sub-menu item	Factory default	Page
[SHIFT]	—	52
[ASPECT]	[NORMAL]	53
[ZOOM]	—	53
[CLOCK PHASE]	[16] ^{*1}	54
[KEystone]	[0]	55

*1 Depends on the signal input.

[ADVANCED MENU]

Sub-menu item	Factory default	Page
[DIGITAL CINEMA REALITY]	[AUTO] ^{*1}	56
[BLANKING]	—	56
[INPUT RESOLUTION]	—	57
[CLAMP POSITION]	[24] ^{*1}	57
[FRAME RESPONSE]	[NORMAL]	58
[RASTER POSITION]	—	58

*1 Depends on the signal input.

Note

- Sub-menu items and factory default settings differ depending on the input terminal that is selected.

[DISPLAY LANGUAGE] 

Details (→ page 59)

[DISPLAY OPTION] 

Sub-menu item	Factory default	Page
[COLOR MATCHING]	[OFF]	60
[SCREEN SETTING] ^{*1}	—	61
[AUTO SIGNAL]	[OFF]	62
[AUTO SETUP]	—	62
[COMPUTER IN]	—	62
[DVI-I IN]	—	63
[HDMI IN]	—	64
[DIGITAL LINK IN]	—	64
[ON-SCREEN DISPLAY]	—	64
[CLOSED CAPTION SETTING]	—	66
[BACK COLOR]	[BLUE]	67
[STARTUP LOGO]	[DEFAULT LOGO]	67
[SUB MEMORY LIST]	—	68
[FREEZE]	—	68
[AV MUTE]	—	69

*1 Only for PT-RW330EA.

[PROJECTOR SETUP] 

Sub-menu item	Factory default	Page
[PROJECTOR ID]	[ALL]	70
[PROJECTION METHOD]	[FRONT/FLOOR]	70
[COOLING CONDITION]	[FLOOR SETTING]	71
[HIGH ALTITUDE MODE]	[OFF]	71
[ECO MANAGEMENT]	—	71
[SCHEDULE]	[OFF]	73
[INITIAL STARTUP]	[LAST MEMORY]	75
[STARTUP INPUT SELECT]	[LAST USED]	75
[DIGITAL LINK INPUT]	—	76
[RS-232C]	—	76
[FUNCTION BUTTON]	—	78
[AUDIO SETTING]	—	78
[STATUS]	—	80
[DATE AND TIME]	—	80
[SAVE ALL USER DATA]	—	81
[LOAD ALL USER DATA]	—	81
[INITIALIZE]	—	82
[SERVICE PASSWORD]	—	82

[TEST PATTERN] 

Details (➔ page 83)

[SIGNAL LIST] 

Details (➔ page 84)

[SECURITY] 

Sub-menu item	Factory default	Page
[SECURITY PASSWORD]	[OFF]	86
[SECURITY PASSWORD CHANGE]	—	86
[TEXT DISPLAY]	[OFF]	87
[TEXT CHANGE]	—	87
[MENU LOCK]	[OFF]	87
[MENU LOCK PASSWORD]	—	87
[CONTROL DEVICE SETUP]	—	88

[NETWORK] 

Sub-menu item	Factory default	Page
[DIGITAL LINK MODE]	[AUTO]	89
[DIGITAL LINK SETUP]	—	89
[DIGITAL LINK STATUS]	—	90
[NETWORK SETUP]	—	91
[NETWORK CONTROL]	—	91
[NETWORK STATUS]	—	92

[DIGITAL LINK] 

Details (➔ page 108)

Note

- Some items may not be adjusted or used for certain signal formats to be input to the projector.
- The menu items that cannot be adjusted or used are shown in gray characters, and they cannot be selected.
- Sub-menu items and factory default settings differ depending on the selected input terminal.

[PICTURE] menu

On the menu screen, select [PICTURE] from the main menu, and select the item from the sub-menu.

Refer to “Navigating through the menu” (⇒ page 42) for the operation of the menu screen.

- After selecting the item, press ▲▼◀▶ to set.

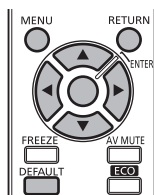

[PICTURE MODE]

You can switch to the desired picture mode suitable for the image source and the environment in which the projector is used.

1) Press ▲▼ to select [PICTURE MODE].

2) Press ◀▶ to switch [PICTURE MODE].

- The items will switch each time you press the button.

[GRAPHIC]	The image becomes suitable for input from the personal computer.
[STANDARD]	The image becomes suitable for moving images in general.
[CINEMA]	The image becomes suitable for movie sources.
[NATURAL]	The image is sRGB compliant.
[REC709]*1	The image is REC709 compliant.
[DICOM SIM.]*1	The image becomes similar to that of DICOM Part 14 Grayscale Standard.
[DYNAMIC]	Color and brightness are optimized and image becomes suitable for video content.

*1 Use the factory default for the settings other than [PICTURE MODE].

Note

- The factory default picture mode is [GRAPHIC] for still image input signals and [STANDARD] for movie based input signals.
- DICOM is an abbreviation of “Digital Imaging and COmmunication in Medicine” and is a standard for medical imaging devices. Although the DICOM name is used, the projector is not a medical device, and should not be used for purposes such as diagnosis of displayed images.

[CONTRAST]

You can adjust the contrast of the colors.

1) Press ▲▼ to select [CONTRAST].

2) Press ◀▶ or the <ENTER> button.

- The [CONTRAST] individual adjustment screen is displayed.

3) Press ◀▶ to adjust the level.

Operation	Adjustment	Range
Press the ▶ button.	Brightens the screen and makes the color deeper.	-31 - 31
Press the ◀ button.	Darkens the screen and makes the color lighter.	

Attention

- Adjust [BRIGHTNESS] first when you need to adjust the black level.

[BRIGHTNESS]

You can adjust the dark (black) part of the projected image.

- 1) Press ▲▼ to select [BRIGHTNESS].
- 2) Press ◀▶ or the <ENTER> button.
 - The [BRIGHTNESS] individual adjustment screen is displayed.
- 3) Press ◀▶ to adjust the level.

Operation	Adjustment	Range
Press the ▶ button.	Increases the brightness of the dark (black) parts of the screen.	-31 - 31
Press the ◀ button.	Reduces the brightness of the dark (black) parts of the screen.	

[COLOR]

You can adjust the color saturation of the projected image.

- 1) Press ▲▼ to select [COLOR].
- 2) Press ◀▶ or the <ENTER> button.
 - The [COLOR] individual adjustment screen is displayed.
- 3) Press ◀▶ to adjust the level.

Operation	Adjustment	Range
Press the ▶ button.	Deepens colors.	-31 - 31
Press the ◀ button.	Weakens colors.	

[TINT]

You can adjust the skin tone in the projected image.

- 1) Press ▲▼ to select [TINT].
- 2) Press ◀▶ or the <ENTER> button.
 - The [TINT] individual adjustment screen is displayed.
- 3) Press ◀▶ to adjust the level.

Operation	Adjustment	Range
Press the ▶ button.	Adjusts skin tone toward greenish color.	-31 - 31
Press the ◀ button.	Adjusts skin tone toward reddish purple.	

[COLOR TEMPERATURE]

You can switch the color temperature if the white areas of the projected image are bluish or reddish.

Adjusting with color temperature

- 1) Press ▲▼ to select [COLOR TEMPERATURE].
- 2) Press ◀▶ or the <ENTER> button.
 - The [COLOR TEMPERATURE] individual adjustment screen is displayed.
- 3) Press ◀▶ to switch [COLOR TEMPERATURE].
 - The items will switch each time you press the button.

[DEFAULT]	Factory default setting.
[USER]	Adjusts white balance as desired. Refer to “Adjusting desired white balance” to be described later for details.
[MIDDLE]	Select so that images become natural.
[HIGH]	

Note

- When [PICTURE MODE] (➔ page 47) is set to [DYNAMIC], [COLOR TEMPERATURE] is fixed to [USER]. (However, [WHITE BALANCE HIGH] cannot be adjusted.)
- When [COLOR MATCHING] (➔ page 60) adjustment is set to other than [OFF], [COLOR TEMPERATURE] is fixed to [USER].

Adjusting desired white balance

- 1) Press ▲▼ to select [COLOR TEMPERATURE].
- 2) Press ◀▶ or the <ENTER> button.
 - The [COLOR TEMPERATURE] individual adjustment screen is displayed.
- 3) Press ◀▶ to select [USER].
- 4) Press the <ENTER> button.
 - The [COLOR TEMPERATURE] screen is displayed.
- 5) Press ▲▼ to select [WHITE BALANCE].
- 6) Press the <ENTER> button.
 - The [WHITE BALANCE] screen is displayed.
- 7) Press ▲▼ to select [WHITE BALANCE HIGH] or [WHITE BALANCE LOW].
- 8) Press the <ENTER> button.
 - The [WHITE BALANCE HIGH] screen or the [WHITE BALANCE LOW] screen is displayed.
- 9) Press ▲▼ to select [RED], [GREEN], or [BLUE].
- 10) Press ◀▶ to adjust the level.

Item	Operation	Adjustment	Range
[RED]	Press the ▶ button.	Deepens red.	[WHITE BALANCE HIGH]: 0 - 255 (factory default is 255) [WHITE BALANCE LOW]: -127 - 127 (factory default is 0)
	Press the ◀ button.	Weakens red.	
[GREEN]	Press the ▶ button.	Deepens green.	
	Press the ◀ button.	Weakens green.	
[BLUE]	Press the ▶ button.	Deepens blue.	
	Press the ◀ button.	Weakens blue.	

Note

- Adjust [COLOR TEMPERATURE] correctly. All colors will not be displayed properly unless adequate adjustment is made. If the adjustment does not look suitable, you can press the <DEFAULT> button on the remote control to return the setting for the selected item only to the factory default setting.
- The setting of [COLOR TEMPERATURE] is not reflected in internal test patterns (➔ page 83). Make sure to set [COLOR TEMPERATURE] while projecting input signal.

Changing the [USER] name

- 1) Press ▲▼ to select [COLOR TEMPERATURE].
- 2) Press ◀▶ or the <ENTER> button.
 - The [COLOR TEMPERATURE] individual adjustment screen is displayed.
- 3) Press ◀▶ to select [USER].
- 4) Press the <ENTER> button.
 - The [COLOR TEMPERATURE] screen is displayed.
- 5) Press ▲▼ to select [COLOR TEMPERATURE NAME CHANGE].
- 6) Press the <ENTER> button.
 - The [COLOR TEMPERATURE NAME CHANGE] screen is displayed.
- 7) Press ▲▼◀▶ to select the text, and press the <ENTER> button to enter the text.

8) Press ▲▼◀▶ to select [OK], and press the <ENTER> button.

- The name set to color temperature is changed.

Note

- When a name is changed, display of the [USER] menu is also changed.

[DAYLIGHT VIEW]

You can correct the image to the optimal vividness even if it is projected under a bright light.

1) Press ▲▼ to select [DAYLIGHT VIEW].

2) Press ◀▶ or the <ENTER> button.

- The [DAYLIGHT VIEW] individual adjustment screen is displayed.

3) Press ◀▶ to switch [DAYLIGHT VIEW].

- The items will switch each time you press the button.

[AUTO]	Corrects the image vividness automatically.
[OFF]	No correction.
[1]	Corrects the image to weaken vividness.
[2]	Corrects the image to medium vividness.
[3]	Corrects the image to high vividness.

Note

- If [REAR/FLOOR] or [REAR/CEILING] is selected with the [PROJECTOR SETUP] menu → [PROJECTION METHOD], [AUTO] cannot be set.
- [AUTO] mode may not operate properly if objects are placed on top of the projector.
- If [PICTURE MODE] is [NATURAL], [REC709], or [DICOM SIM.], the factory default setting is [OFF].

[SHARPNESS]

You can adjust the sharpness of the projected image.

1) Press ▲▼ to select [SHARPNESS].

2) Press ◀▶ or the <ENTER> button.

- The [SHARPNESS] individual adjustment screen is displayed.

3) Press ◀▶ to adjust the level.

Operation	Adjustment	Range
Press the ▶ button.	Contours become sharper.	0 - 15
Press the ◀ button.	Contours become softer.	

Note

- If you press ▶ while the adjustment value is [15], the value will become [0]. If you press ◀ while the adjustment value is [0], the value will become [15].

[NOISE REDUCTION]

You can reduce noises when the input image is degraded and noise is occurring in the image signal.

1) Press ▲▼ to select [NOISE REDUCTION].

2) Press ◀▶ or the <ENTER> button.

- The [NOISE REDUCTION] individual adjustment screen is displayed.

3) Press ◀▶ to switch [NOISE REDUCTION].

- The items will switch each time you press the button.

[OFF]	No correction.
[ON]	Corrects the noise.

Attention

- Setting the projector may result in an image that appears different from the actual image. In such a case, set it to [OFF].

[SYSTEM SELECTOR]

The projector will automatically detect the input signal, but you can set the system method manually when an unstable signal is input. Set the system method matching the input signal.

1) Press **▲▼** to select [SYSTEM SELECTOR].

2) Press the **<ENTER>** button.

3) Press **▲▼** to select a system format.

- Available system formats vary depending on the input signal.

Terminal	System format	
<VIDEO IN> terminal	Select [AUTO], [NTSC], [NTSC4.43], [PAL], [PAL-M], [PAL-N], [SECAM], or [PAL60]. Set it to [AUTO] normally. (The [AUTO] setting will automatically select [NTSC], [NTSC4.43], [PAL], [PAL-M], [PAL-N], [SECAM], or [PAL60].) Switch the setting to the signal method for the TV used.	
<COMPUTER IN> terminal, <DVI-I IN> terminal ^{*1}	480i, 576i, or 576p signal	Select [RGB] or [YCbCr].
	VGA60 or 480p signal	Select [VGA60], [480p], or [480pRGB].
	Other movie based signals	Select [RGB] or [YPbPr].
<DVI-I IN> terminal ^{*2}	480p or 576p signal	Select [RGB], [YCbCr444], or [YCbCr422].
	Other movie based signals	Select [RGB], [YPbPr444], or [YPbPr422].
<HDMI IN> terminal	480p or 576p signal	Select [AUTO], [RGB], [YCbCr444], or [YCbCr422].
	Other movie based signals	Select [AUTO], [RGB], [YPbPr444], or [YPbPr422].

*1 When [DVI-I IN] is set to [ANALOG].

*2 When [DVI-I IN] is set to [DIGITAL].

4) Press the **<ENTER>** button.

Note

- Refer to “List of compatible signals” (➔ page 122) for compatible signals.
- This may not function properly for some external devices that are connected.

sRGB-compliant video

sRGB is an international standard (IEC61966-2-1) for color reproduction defined by IEC (International Electrotechnical Commission). Set the projector using the following procedures for more accurate color reproduction that complies with sRGB.

1) Set [COLOR MATCHING] adjustments to [OFF].

- Refer to [COLOR MATCHING] (➔ page 60).

2) Display the [PICTURE] menu.

- Refer to “[PICTURE] menu” (➔ page 47).

3) Press **▲▼** to select [PICTURE MODE].

4) Press **◀▶** to set [NATURAL].

5) Press **▲▼** to select [COLOR].

6) Press the **<DEFAULT>** button on the remote control to set factory default settings.

7) Follow Steps 5) to 6) to set factory default settings for [TINT] and [COLOR TEMPERATURE].

Note

- sRGB is available for RGB signal input only.

[POSITION] menu

On the menu screen, select [POSITION] from the main menu, and select the item from the sub-menu.

Refer to “Navigating through the menu” (⇒ page 42) for the operation of the menu screen.

- After selecting the item, press ▲▼◀▶ to set.

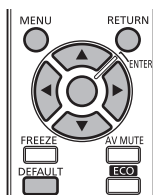

Note

- When the input is set to DIGITAL LINK, only [KEYSTONE] can be set. When the optional digital interface box (ET-YFB100G) is connected to the projector, adjust the shift, aspect, and clock phase from the menu of ET-YFB100G.

[SHIFT]

You can move the image position vertically or horizontally if the image position projected on the screen is shifted even when the relative position of the projector and the screen is installed correctly.

- 1) Press ▲▼ to select [SHIFT].
- 2) Press the <ENTER> button.
 - The [SHIFT] screen is displayed.
- 3) Press ▲▼◀▶ to adjust the position.

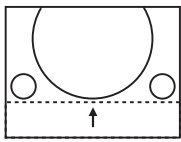
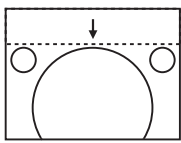
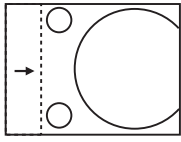
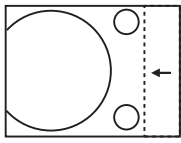
Orientation	Operation	Adjustment
Vertical (up and down) adjustment	Press the ▲ button.	The image position moves up. 
	Press the ▼ button.	The image position moves down. 
Horizontal (right and left) adjustment	Press the ▶ button.	The image position moves to the right. 
	Press the ◀ button.	The image position moves to the left. 

[ASPECT]

You can switch the aspect ratio of the image.

The aspect ratio is switched within the screen range selected in [SCREEN SETTING]. Set [SCREEN SETTING] first. (➔ page 61)
[SCREEN SETTING] is available only on PT-RW330EA.

- 1) Press ▲▼ to select [ASPECT].
- 2) Press ◀▶ or the <ENTER> button.
 - The [ASPECT] individual adjustment screen is displayed.
- 3) Press ◀▶ to switch [ASPECT].
 - The items will switch each time you press the button.

[NORMAL]	Display images without changing the aspect ratio of the input signals.
[NATIVE]	Display images without changing the resolution of the input signals.
[WIDE]	Display images with the aspect ratio converted to 16:9 when standard signals are input ^{*1} . Display images without changing the aspect ratio when wide-screen signals are input ^{*2} .
[4:3]	Display images without changing the aspect ratio when standard signals are input ^{*1} . Display images without changing the aspect ratio so that the images will fit in the 4:3 screen when wide-screen signals are input ^{*2} .
[H FIT]	Display images using the entire width of the screen. When signals have the aspect ratio vertically longer than the aspect ratio of the screen selected in [SCREEN FORMAT] ^{*3} , the images are displayed with the top and bottom parts cut off.
[V FIT]	Display images using the entire height of the screen range selected in [SCREEN FORMAT] ^{*3} . When signals have the aspect ratio horizontally longer than the aspect ratio of the screen selected in [SCREEN FORMAT] ^{*3} , the images are displayed with the right and left parts cut off.
[FULL]	Display images in the entire screen range selected in [SCREEN FORMAT] ^{*3} . When the aspect ratio of the input signals differs from that of the screen range, the images are displayed with the aspect ratio converted to that of the screen selected in [SCREEN FORMAT] ^{*3} .

*1 Standard signals are input signals with an aspect ratio of 4:3 or 5:4.

*2 Wide-screen signals are input signals with an aspect ratio of 16:10, 16:9, 15:9 or 15:10.

*3 For PT-RZ370EA, the [SCREEN FORMAT] setting is not available. The screen aspect ratio of PT-RZ370EA is 16:9.

Note

- If an aspect ratio different from the aspect ratio for the input signals is selected, the images will appear to be different from the originals. Be careful of this when selecting the aspect ratio.
- If using the projector in places such as cafes or hotels to display programs for a commercial purpose or for public presentation, note that adjusting the aspect ratio or using the zoom function to change the screen images may be an infringement of the rights of the original copyright owner for that program under copyright protection laws. Take care when using a function of the projector such as the aspect ratio adjustment and zoom function.
- If conventional (normal) 4:3 images which are not wide-screen images are displayed on a wide screen, the edges of the images may not be visible or they may become distorted. Such images should be viewed as with an aspect ratio of 4:3 in the original format intended by the creator of the images.

[ZOOM]

You can adjust the size of the screen size.

When [ASPECT] is set to other than [NORMAL] and [NATIVE]

- 1) Press ▲▼ to select [ZOOM].
- 2) Press the <ENTER> button.
 - The [ZOOM] screen is displayed.
- 3) Press ▲▼ to select [INTERLOCKED].
- 4) Press ◀▶ to switch [INTERLOCKED].

[OFF]	Set the [VERTICAL] and [HORIZONTAL] zoom ratio.
[ON]	Use [BOTH] to set zoom ratio. Horizontal and vertical can be expanded by units of 1.0 time.

- 5) Press ▲▼ to select [VERTICAL] or [HORIZONTAL].
 - If [ON] is selected, select [BOTH].
- 6) Press ◀▶ to adjust.

Note

- When [ASPECT] is set to [NATIVE], [ZOOM] cannot be adjusted.

When [ASPECT] is set to [NORMAL]

- 1) Press ▲▼ to select [ZOOM].
- 2) Press the <ENTER> button.
 - The [ZOOM] screen is displayed.
- 3) Press ▲▼ to select [MODE].
- 4) Press ◀▶ to switch [MODE].

[INTERNAL]	Enlarges the size within the aspect range set with [SCREEN FORMAT].
[FULL]	Enlarges the size to the entire display area set with [SCREEN FORMAT].

- 5) Press ▲▼ to select [INTERLOCKED].
- 6) Press ◀▶ to switch [INTERLOCKED].

[OFF]	Set the [VERTICAL] and [HORIZONTAL] zoom ratio.
[ON]	Use [BOTH] to set zoom ratio. Horizontal and vertical can be expanded by units of 1.0 time.

- 7) Press ▲▼ to select [VERTICAL] or [HORIZONTAL].
 - If [ON] is selected, select [BOTH].
- 8) Press ◀▶ to adjust.

Note

- When [ASPECT] is set to other than [NORMAL], [MODE] is not displayed.

[CLOCK PHASE]

You can adjust to achieve an optimal image when there is a flickering image or smeared outlines.

- 1) Press ▲▼ to select [CLOCK PHASE].
- 2) Press ◀▶ or the <ENTER> button.
 - The [CLOCK PHASE] individual adjustment screen is displayed.
- 3) Press ◀▶ to adjust.
 - Adjustment value will change between [0] and [31]. Adjust so that the amount of interference is at a minimum.

Note

- Optimal value may not be achieved if the output from the input computer is unstable.
- Optimal value may not be achieved when there is a shift in the total dot numbers.
- [CLOCK PHASE] can be adjusted only when an analog signal is input to the <COMPUTER IN> terminal or the <DVI-I IN> terminal.
- [CLOCK PHASE] cannot be adjusted when a digital signal is input.
- If you press ▶ while the adjustment value is [31], the value will become [0]. If you press ◀ while the adjustment value is [0], the value will become [31].

[KEYSTONE]

You can correct the trapezoidal distortion that occurs when the projector is installed tilted or when the screen is tilted.

- 1) Press ▲▼ to select [KEYSTONE].
- 2) Press ◀▶ or the <ENTER> button.
 - The [KEYSTONE] individual adjustment screen is displayed.
- 3) Press ◀▶ to adjust.

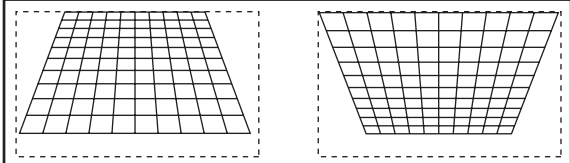
Item	Details
[KEYSTONE]	

Note

- [KEYSTONE] can be corrected up to $\pm 40^\circ$ for tilt in the vertical direction. However, the image quality will degrade and it will get harder to focus with more correction. Install the projector so the correction will be as small as possible.
- [KEYSTONE] will also change the image size.
- Trapezoidal distortion may occur depending on the lens shift position.
- Aspect ratio of the image size may shift depending on the correction or lens zoom value.

[ADVANCED MENU] menu

On the menu screen, select [ADVANCED MENU] from the main menu, and select the item from the sub-menu.

Refer to “Navigating through the menu” (⇒ page 42) for the operation of the menu screen.

- After selecting the item, press ▲▼◀▶ to set.

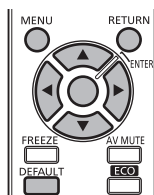

[DIGITAL CINEMA REALITY]

You can increase the vertical resolution and enhance the image quality by performing the cinema processing when the PAL (or the SECAM) 576i signal, the NTSC 480i, 1080/50i, and 1080/60i signals are input.

1) Press ▲▼ to select [DIGITAL CINEMA REALITY].

2) Press ◀▶ to switch [DIGITAL CINEMA REALITY].

- The items will switch each time you press the button.

[AUTO]	Performs automatic detection and cinema processing. (Factory default)
[OFF]	Unforced cinema processing.

Note

- When [FRAME RESPONSE] is set to [FAST], [DIGITAL CINEMA REALITY] cannot be set.

[BLANKING]

The blanking width is adjusted when there are noises at the edge of the screen or the image is slightly running out from the screen when an image from the VCR or other devices are projected.

1) Press ▲▼ to select [BLANKING].

2) Press the <ENTER> button.

- The [BLANKING] adjustment screen is displayed.

3) Press ▲▼ to select [UPPER], [LOWER], [LEFT], or [RIGHT].

4) Press ◀▶ to adjust the blanking.

- The adjustment range is within 10 % of the resolution in each direction, and changes depending on the input signal.

Blanking correction	Item	Operation	Adjustment	Range	
Top of the screen	[UPPER]	Press the ◀ button.	The blanking zone moves upward.		Top and bottom: 0 (lower limit)
		Press the ▶ button.	The blanking zone moves downward.		
Bottom of the screen	[LOWER]	Press the ▶ button.	The blanking zone moves upward.		
		Press the ◀ button.	The blanking zone moves downward.		

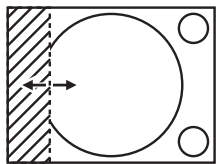
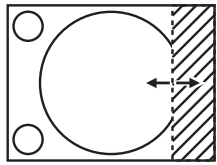
Blanking correction	Item	Operation	Adjustment	Range	
Left side of the screen	[LEFT]	Press the ► button.	The blanking zone moves to the right.		Left and right: 0 (lower limit)
		Press the ◀ button.	The blanking zone moves to the left.		
Right side of the screen	[RIGHT]	Press the ◀ button.	The blanking zone moves to the right.		
		Press the ► button.	The blanking zone moves to the left.		

[INPUT RESOLUTION]

You can adjust to achieve an optimal image when there is a flickering image or smeared outlines.

1) Press ▲▼ to select [INPUT RESOLUTION].

2) Press the <ENTER> button.

- The [INPUT RESOLUTION] screen is displayed.

3) Press ▲▼ to select [TOTAL DOTS], [DISPLAY DOTS], [TOTAL LINES], or [DISPLAY LINES], and press ◀▶ to adjust it.

- Values corresponding to the signal being input are displayed automatically for each item. Increase or decrease the displayed values and adjust to the optimal point viewing the screen when there are vertical stripes or sections are missing from the screen.

Note

- Previously mentioned vertical banding will not occur with all white signal input.
- The image may be disrupted while performing the adjustment, but it is not a malfunction.
- [INPUT RESOLUTION] can be adjusted only when an analog RGB signal is input to the <COMPUTER IN> terminal or the <DVI-I IN> terminal.
- Certain signals may not be adjustable.

[CLAMP POSITION]

You can adjust the optimal point when the black part of the image is blunt or it has turned green.

1) Press ▲▼ to select [CLAMP POSITION].

2) Press ◀▶ to adjust.

Status	Rough guide for optimal value	Range
The black part is blunt.	The point where bluntness of the black part improves the most is the optimal value.	1 - 255
The black part is green.	The point where the green part becomes black, and the bluntness has improved is the optimal value.	

Note

- [CLAMP POSITION] can be adjusted only when an analog signal is input to the <COMPUTER IN> terminal or the <DVI-I IN> terminal.
- Certain signals may not be adjustable.

[FRAME RESPONSE]

If 1 080/60i, 1 080/50i, or 1 080/24sF signals are input, the video frame delay can be shortened by simplifying video processing.

1) Press ▲▼ to select [FRAME RESPONSE].

2) Press ◀▶ to switch [FRAME RESPONSE].

- The items will switch each time you press the button.

[NORMAL]	Sets a priority on image quality.
[FAST]	Sets a limit to the time delay.

Note

- Selecting [NORMAL] allows images to be viewed in higher quality.
- If the [NOISE REDUCTION] setting is [ON], the [FRAME RESPONSE] cannot be set.

[RASTER POSITION]

This will allow the position of the image to move within the display area arbitrarily when the input image is not using the whole display area.

1) Press ▲▼ to select [RASTER POSITION].

2) Press the <ENTER> button.

- The [RASTER POSITION] screen is displayed.

3) Press ▲▼◀▶ to adjust the position.

[DISPLAY LANGUAGE] menu

On the menu screen, select [DISPLAY LANGUAGE] from the main menu, and display the sub-menu.

Refer to “Navigating through the menu” (➔ page 42) for the operation of the menu screen.

- Press ▲▼ to select a language, and press the <ENTER> button to set.

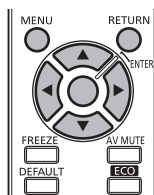

Changing the display language

You can select the language of the on-screen display.

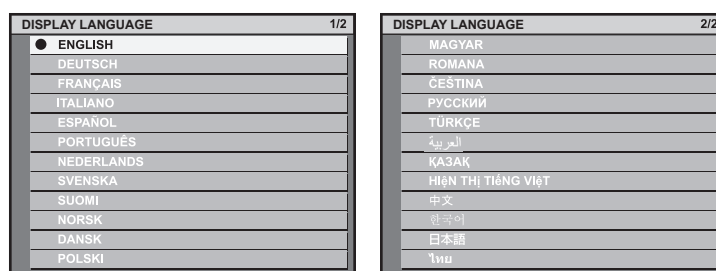

- Various menus, settings, adjustment screens, control button names, etc., are displayed in the selected language.
- The language can be changed to English, German, French, Italian, Spanish, Portuguese, Dutch, Swedish, Finnish, Norwegian, Danish, Polish, Hungarian, Romanian, Czech, Russian, Turkish, Arabic, Kazakh, Vietnamese, Chinese, Korean, Japanese, and Thai.

Note

- The on-screen display language of the projector is set to English by default, and also when [INITIALIZE] [ALL USER DATA] (➔ page 82) is executed.

[DISPLAY OPTION] menu

On the menu screen, select [DISPLAY OPTION] from the main menu, and select the item from the sub-menu.

Refer to “Navigating through the menu” (➔ page 42) for the operation of the menu screen.

- After selecting the item, press ▲▼◀▶ to set.

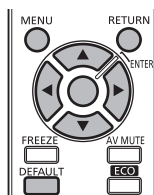

[COLOR MATCHING]

You can correct the color difference between the sets when multiple sets are to be used simultaneously.

Adjusting the color matching as desired

1) Press ▲▼ to select [COLOR MATCHING].

2) Press ◀▶ to switch [COLOR MATCHING].

- The items will switch each time you press the button.

[OFF]	Color matching adjustment is not carried out.
[3COLORS]	The three colors [RED], [GREEN], or [BLUE] can be adjusted.
[7COLORS]	The seven colors [RED], [GREEN], [BLUE], [CYAN], [MAGENTA], [YELLOW], or [WHITE] can be adjusted.
[MEASURED]	Refer to “Adjusting the color matching using a colorimeter” (➔ page 61) for details about this mode.

3) Select [3COLORS] or [7COLORS], and press the <ENTER> button.

- The [3COLORS] or [7COLORS] screen is displayed.

4) Press ▲▼ to select [RED], [GREEN], [BLUE], or [WHITE] ([RED], [GREEN], [BLUE], [CYAN], [MAGENTA], [YELLOW], or [WHITE] for [7COLORS]).

5) Press the <ENTER> button.

- The [3COLORS:RED], [3COLORS:GREEN], [3COLORS:BLUE], or [3COLORS:WHITE] screen is displayed.
For [7COLORS], the [7COLORS:RED], [7COLORS:GREEN], [7COLORS:BLUE], [7COLORS:CYAN], [7COLORS:MAGENTA], [7COLORS:YELLOW], or [7COLORS:WHITE] screen is displayed.

6) Press ▲▼ to select [RED], [GREEN], or [BLUE].

- If [WHITE] is selected from [3COLORS], only [GAIN] can be adjusted.

7) Press ◀▶ to adjust.

- Adjustment value will change between 0 and 2 048*1.

*1 Depends on the signal input.

Note

- Operation when correcting the adjustment color
When the correction color same as the adjustment color is changed: The luminance of the adjustment color changes.
When correction color red is changed: Red is added to or subtracted from the adjustment color.
When correction color green is changed: Green is added to or subtracted from the adjustment color.
When correction color blue is changed: Blue is added to or subtracted from the adjustment color.
- This adjustment should be carried out by a person who is familiar with the projector or by a service person because a high level of skill is required to make a successful adjustment.
- Pressing the <DEFAULT> button will restore the factory default settings for all items.
- If [COLOR MATCHING] is set to other than [OFF], [COLOR TEMPERATURE] is fixed to [USER]. (However, [WHITE BALANCE HIGH] cannot be adjusted.)
- When [PICTURE MODE] (➔ page 47) is set to [DYNAMIC], [COLOR MATCHING] cannot be adjusted.

Adjusting the color matching using a colorimeter

Use a colorimeter that can measure chromaticity coordinates and luminance to change the colors [RED], [GREEN], [BLUE], [CYAN], [MAGENTA], [YELLOW], or [WHITE] to desired colors.

- 1) Press ▲▼ to select [COLOR MATCHING].
- 2) Press ◀▶ to select [MEASURED].
- 3) Press the <ENTER> button.
 - The [MEASURED MODE] screen is displayed.
- 4) Press ▲▼ to select [MEASURED DATA].
- 5) Press the <ENTER> button.
 - The [MEASURED DATA] screen is displayed.
- 6) Measure the current luminance (Y) and the chromaticity coordinates (x, y) using the colorimeter.
- 7) Press ▲▼ to select a color, and press ◀▶ to adjust the setting.
- 8) Once all the input is completed, press the <MENU> button.
 - The [MEASURED MODE] screen is displayed.
- 9) Press ▲▼ to select [TARGET DATA].
- 10) Press the <ENTER> button.
 - The [TARGET DATA] screen is displayed.
- 11) Press ▲▼ to select a color and press ◀▶ to input coordinates for desired colors.
- 12) Once all the input is completed, press the <MENU> button.

Note

- Colors are not displayed properly when target data is a color outside the region of this projector.
- Set the [AUTO TESTPATTERN] to [ON] to automatically display a test pattern for use in adjusting the selected adjustment colors.
- When using a colorimeter or similar instrument to measure measurement data, measure the colors displayed with [AUTO TESTPATTERN].
- A difference in the color coordinates of target data and measurement values obtained from an instrument may occur for certain instruments and measurement environments used.

[SCREEN SETTING] (only for PT-RW330EA)

Set the screen size.

When changing the aspect of a projected image, correct to the optimum image position for the set screen. Set as necessary for the screen in use.

- 1) Press ▲▼ to select [SCREEN SETTING].
- 2) Press the <ENTER> button.
 - The [SCREEN SETTING] screen is displayed.
- 3) Press ◀▶ to switch [SCREEN FORMAT].
 - The items will switch each time you press the button.

[SCREEN FORMAT]	Range when [SCREEN POSITION] is selected
[16:10]	Cannot be adjusted.
[16:9]	Vertical position can be adjusted between -40 and 40.

- 4) Press ▲▼ to select [SCREEN POSITION].
 - When [SCREEN FORMAT] is set to [16:10], [SCREEN POSITION] cannot be selected or adjusted.
- 5) Press ◀▶ to adjust [SCREEN POSITION].

[AUTO SIGNAL]

Set automatic execution of auto setup.

The screen display position or signal level can be adjusted automatically without pressing the <AUTO SETUP> button on the remote control on each occasion if you input unregistered signals frequently at meetings, etc.

1) Press ▲▼ to select [AUTO SIGNAL].

2) Press ◀▶ to switch [AUTO SIGNAL].

- The items will switch each time you press the button.

[OFF]	Set input auto setup to off.
[ON]	Auto setup is automatically executed when images are changed to unregistered signals during projection.

[AUTO SETUP]

You can set when adjusting a special signal or horizontally long (such as 16:9) signal.

1) Press ▲▼ to select [AUTO SETUP].

2) Press the <ENTER> button.

- The [AUTO SETUP] screen is displayed.

3) Press ◀▶ to switch [MODE].

- The items will switch each time you press the button.

[DEFAULT]	Select when receiving a signal whose image aspect is 4:3 or 5:4. (Supported resolutions are 640 x 400, 640 x 480, 800 x 600, 832 x 624, 960 x 720, 1 024 x 768, 1 152 x 864, 1 152 x 870, 1 280 x 960, 1 280 x 1 024, 1 600 x 1 200, and 1 400 x 1 050)
[WIDE]	Select when receiving a signal whose image aspect is wide-screen. (Supported resolutions are 720 x 400, 848 x 480, 1 280 x 720, 1 024 x 600, 1 120 x 750, 1 440 x 900, and 1 680 x 1 050)
[USER]	Select when receiving a signal with a special horizontal resolution (number of display dots).

- When [DEFAULT] or [WIDE] is selected, proceed to Step 6).
- When [USER] is selected, proceed to Step 4).

4) Press ▲▼ to select [DISPLAY DOTS], and press ◀▶ to adjust [DISPLAY DOTS] to the horizontal resolution of the signal source.

5) Press ▲▼ to select [MODE].

6) Press the <ENTER> button.

- Automatic adjustment is executed. [PROGRESS] is displayed while automatically adjusting. When complete, the system returns to the [AUTO SETUP] screen.

[COMPUTER IN]

Set to match the signal to input to the <COMPUTER IN> terminal.

1) Press ▲▼ to select [COMPUTER IN].

2) Press the <ENTER> button.

- The [COMPUTER IN] screen is displayed.

3) Press ◀▶ to switch [SYNC SLICE LEVEL].

- The items will switch each time you press the button.

[LOW]	Set the slice level to [LOW].
[HIGH]	Set the slice level to [HIGH].

[DVI-I IN]

Switch the setting when the external equipment is connected to the <DVI-I IN> terminal of the projector and the image is not projected correctly.

When digital signals are input

- 1) Press ▲▼ to select [DVI-I IN].
- 2) Press the <ENTER> button.
 - The [DVI-I IN] screen is displayed.
- 3) Press ▲▼ to select [DIGITAL/ANALOG].
- 4) Press ◀▶ to switch [DIGITAL].
- 5) Press ▲▼ to select [EDID].
- 6) Press ◀▶ to switch [EDID].
 - The items will switch each time you press the button.

[EDID3]	Recognize movie-type image signals and still image-type signals automatically.
[EDID1]	Select mainly when an external device that outputs movie-type image signals (such as a blu-ray disk player) is connected to the <DVI-I IN> terminal.
[EDID2]	Select mainly when an external device that outputs still image-type signals (such as a computer) is connected to the <DVI-I IN> terminal.

- 7) Press ▲▼ to select [SIGNAL LEVEL].
- 8) Press ◀▶ to switch [SIGNAL LEVEL].
 - The items will switch each time you press the button.

[0-255:PC]	Select when an external device (such as a computer) is connected via DVI terminal output.
[16-235]	Select when an external device (such as a blu-ray disc player) is connected via HDMI terminal output by use of a conversion cable or similar cable.

When analog signals are input

- 1) Press ▲▼ to select [DVI-I IN].
- 2) Press the <ENTER> button.
 - The [DVI-I IN] screen is displayed.
- 3) Press ▲▼ to select [DIGITAL/ANALOG].
- 4) Press ◀▶ to switch to [ANALOG].
- 5) Press ▲▼ to select [SYNC SLICE LEVEL].
- 6) Press ◀▶ to switch [SYNC SLICE LEVEL].
 - The items will switch each time you press the button.

[LOW]	Set the slice level to [LOW].
[HIGH]	Set the slice level to [HIGH].

Note

- The optimal setting is different depending on the output setting of the connected external equipment. Refer to the instruction manual of the external equipment regarding the output of the external equipment.
- The data for Plug and play will change when the setting is changed. Refer to "List of compatible signals" (➡ page 122) for a resolution that supports plug and play.

[HDMI IN]

Switch the setting when an external device is connected using the <HDMI IN> terminal of the projector and the image is not projected correctly.

- 1) Press **▲▼** to select **[HDMI IN]**.
- 2) Press the **<ENTER>** button.
 - The **[HDMI IN]** screen is displayed.
- 3) Press **◀▶** to switch **[SIGNAL LEVEL]**.
 - The items will switch each time you press the button.

[AUTO]	Automatically sets the signal level.
[64-940]	Select when the HDMI terminal of an external device (such as a blu-ray disc player) is connected to the <HDMI IN> terminal.
[0-1023]	Select when the DVI terminal output of an external device (such as a computer) is connected to the <HDMI IN> terminal via a conversion cable or similar cable. Select also when the HDMI terminal output of a computer or other device is connected to the <HDMI IN> terminal.

Note

- The optimal setting is different depending on the output setting of the connected external equipment. Refer to the instruction manual of the external equipment regarding the output of the external equipment.
- The HDMI signal level is displayed per each 30 bits of input.

[DIGITAL LINK IN]

Set the signal level when DIGITAL LINK input is selected.

- 1) Press **▲▼** to select **[DIGITAL LINK IN]**.
- 2) Press the **<ENTER>** button.
 - The **[DIGITAL LINK IN]** screen is displayed.
- 3) Press **◀▶** to switch **[SIGNAL LEVEL]**.
 - The items will switch each time you press the button.

[AUTO]	Automatically sets the signal level.
[64-940]	Select when the HDMI terminal output of an external device (such as a Blu-ray Disc player) is connected to the <DIGITAL LINK/LAN> terminal via a twisted-pair-cable transmitter.
[0-1023]	Select when the DVI terminal output or HDMI terminal output of an external device (such as a computer) is connected to the <DIGITAL LINK/LAN> terminal via a twisted-pair-cable transmitter.

Note

- The optimal setting is different depending on the output setting of the connected external equipment. Refer to the instruction manual of the external equipment regarding the output of the external equipment.

[ON-SCREEN DISPLAY]

Set the on-screen display.

Setting [OSD POSITION]

Set the position of the menu screen (OSD).

- 1) Press **▲▼** to select **[ON-SCREEN DISPLAY]**.
- 2) Press the **<ENTER>** button.
 - The **[ON-SCREEN DISPLAY]** screen is displayed.
- 3) Press **▲▼** to select **[OSD POSITION]**.

4) Press ◀▶ to switch [OSD POSITION].

- The items will switch each time you press the button.

[5]	Sets to the center of the screen.
[6]	Sets to the bottom center of the screen.
[7]	Sets to the upper right of the screen.
[8]	Sets to the right center of the screen.
[9]	Sets to the right bottom of the screen.
[1]	Sets to the upper left of the screen.
[2]	Sets to the center left of the screen.
[3]	Sets to the bottom left of the screen.
[4]	Sets to the top center of the screen.

Setting [OSD DESIGN]

Set the color of the menu screen (OSD).

1) Press ▲▼ to select [ON-SCREEN DISPLAY].**2) Press the <ENTER> button.**

- The [ON-SCREEN DISPLAY] screen is displayed.

3) Press ▲▼ to select [OSD DESIGN].**4) Press ◀▶ to switch [OSD DESIGN].**

- The items will switch each time you press the button.

[1]	Sets to yellow.
[2]	Sets to blue.
[3]	Sets to white.
[4]	Sets to green.
[5]	Sets to peach.
[6]	Sets to brown.

Setting [OSD MEMORY]

Set hold for the position of the menu screen (OSD) cursor.

1) Press ▲▼ to select [ON-SCREEN DISPLAY].**2) Press the <ENTER> button.**

- The [ON-SCREEN DISPLAY] screen is displayed.

3) Press ▲▼ to select [OSD MEMORY].**4) Press ◀▶ to switch [OSD MEMORY].**

- The items will switch each time you press the button.

[ON]	Holds the cursor position.
[OFF]	Does not hold the cursor position.

Note

- Even if [OSD MEMORY] is set to [ON], the cursor position will not be held when the power is turned off and the projector is in standby mode.

Setting [INPUT GUIDE]

Set display of the input guide (display of the currently selected input terminal name, signal name, and memory number) in the position set by the [OSD POSITION].

- 1) Press ▲▼ to select [ON-SCREEN DISPLAY].
- 2) Press the <ENTER> button.
 - The [ON-SCREEN DISPLAY] screen is displayed.
- 3) Press ▲▼ to select [INPUT GUIDE].
- 4) Press ◀▶ to switch [INPUT GUIDE].
 - The items will switch each time you press the button.

[ON]	Displays the input guide.
[OFF]	Does not display the input guide.

Setting [WARNING MESSAGE]

Set the display/hide of the warning message.

- 1) Press ▲▼ to select [ON-SCREEN DISPLAY].
- 2) Press the <ENTER> button.
 - The [ON-SCREEN DISPLAY] screen is displayed.
- 3) Press ▲▼ to select [WARNING MESSAGE].
- 4) Press ◀▶ to switch [WARNING MESSAGE].
 - The items will switch each time you press the button.

[ON]	Displays the warning message.
[OFF]	Does not display the warning message.

[CLOSED CAPTION SETTING] (NTSC input only)

Set closed captions.

Selecting the closed caption display

- 1) Press ▲▼ to select [CLOSED CAPTION SETTING].
- 2) Press the <ENTER> button.
 - The [CLOSED CAPTION SETTING] screen is displayed.
- 3) Press ▲▼ to select [CLOSED CAPTION].
- 4) Press ◀▶ to switch [CLOSED CAPTION].
 - Switch to [OFF] or [ON].

[OFF]	Closed captions are not displayed.
[ON]	Closed captions are displayed.

- When [ON] is selected, proceed to Step 5).

- 5) When the confirmation is displayed, select [OK] or [CANCEL], and press the <ENTER> button.

Setting the closed caption display

- 1) Press ▲▼ to select [CLOSED CAPTION SETTING].
- 2) Press the <ENTER> button.
 - The [CLOSED CAPTION SETTING] screen is displayed.
- 3) Press ▲▼ to select [MODE].

4) Press ◀▶ to switch [MODE].

- The items will switch each time you press the button.

[CC1]	Displays CC1 data.
[CC2]	Displays CC2 data.
[CC3]	Displays CC3 data.
[CC4]	Displays CC4 data.

Note

- Closed captions are a function that is mainly used in North America to display text information with video signals. Captions may not be displayed depending on the connected devices or software being played back.
- [CLOSED CAPTION SETTING] can only be selected if an NTSC signal is input.
- If a closed caption signal of the selected mode is input, the security message and the ECO level (▶ page 73) are not displayed even when the [SECURITY] menu → [TEXT DISPLAY] (▶ page 87) is set to [ON].
- Closed captions are not displayed when the menu screen is displayed.

[BACK COLOR]

Set the display of the projection screen when there is no signal input.

1) Press ▲▼ to select [BACK COLOR].

2) Press ◀▶ to switch [BACK COLOR].

- The items will switch each time you press the button.

[BLUE]	The entire projection area appears blue.
[BLACK]	The entire projection area appears black.
[DEFAULT LOGO]	The Panasonic logo is projected.
[USER LOGO]	The image registered by the user is projected.

Note

- To create and register the image for [USER LOGO], "Logo Transfer Software" included in the supplied CD-ROM is required.

[STARTUP LOGO]

Set the logo display when the power is turned on.

1) Press ▲▼ to select [STARTUP LOGO].

2) Press ◀▶ to switch [STARTUP LOGO].

- The items will switch each time you press the button.

[DEFAULT LOGO]	The Panasonic logo is projected.
[USER LOGO]	The image registered by the user is projected.
[NONE]	No startup logo is projected.

Note

- The startup logo will disappear in approximately 15 seconds.
- To create and register the image for [USER LOGO], "Logo Transfer Software" included in the supplied CD-ROM is required.

[SUB MEMORY LIST]

The projector has a sub memory function that can register the multiple image adjustment data, even if it is recognized as the same signal by the frequency or format of the synchronization signal source.

Use this function when you need to adjust the image quality such as switching of the aspect ratio or white balance by the same synchronization signal source. The sub memory includes all the data that can be adjusted for each signal, such as the screen aspect ratio and data adjusted in the [PICTURE] menu ([CONTRAST], [BRIGHTNESS], etc.).

Registering the current settings to the list

- 1) Press **▲▼** to select [SUB MEMORY LIST], and press the **<ENTER>** button.
 - The sub memory registration screen is displayed if the sub memory is not registered. Proceed to Step 3).
 - A list of sub memories registered to the signal currently input is displayed.
 - [SUB MEMORY LIST] can be displayed by pressing **◀▶** on the normal screen (where the menu is not displayed).
- 2) Press **▲▼◀▶** to select the sub memory number to register in [SUB MEMORY LIST].
- 3) Press the **<ENTER>** button.
 - The [RENAME] screen is displayed.
- 4) Press the **<ENTER>** button.
 - To rename the registered signal, follow the procedure in Steps 4) and 5) in “Renaming the registered signal” (➔ page 84).

Switching to the sub memory list

- 1) Press **▲▼** to select [SUB MEMORY LIST], and press the **<ENTER>** button.
 - A list of sub memories registered to the signal currently input is displayed.
 - [SUB MEMORY LIST] can be displayed by pressing **◀▶** on the normal screen (where the menu is not displayed).
- 2) Press **▲▼◀▶** to select the signal to switch in [SUB MEMORY LIST].
- 3) Press the **<ENTER>** button.
 - This switches to the signal selected in Step 2).

Deleting the sub memory data

- 1) Press **▲▼** to select [SUB MEMORY LIST], and press the **<ENTER>** button.
 - The [SUB MEMORY LIST] screen is displayed.
 - [SUB MEMORY LIST] can be displayed by pressing **◀▶** on the normal screen (where the menu is not displayed).
- 2) Press **▲▼◀▶** to select the item to delete, and press the **<DEFAULT>** button.
 - The [ENTRY SIGNAL DELETE] screen is displayed.
 - To cancel the deletion, press the **<RETURN>** button or the **<MENU>** button to return to the [SUB MEMORY LIST] screen.
- 3) Press the **<ENTER>** button.
 - The selected sub memory will be deleted.

[FREEZE]

The projected image is paused temporarily and the sound stopped regardless of the playback of the external equipment.

- 1) Press **▲▼** to select [FREEZE].
- 2) Press the **<ENTER>** button.
 - Press the **<RETURN>** button to release.

Note

- [FREEZE] is displayed on the screen when video is paused.

[AV MUTE]

Image and audio are muted when the projector is not used for a certain period of time.

- 1) Press ▲▼ to select [AV MUTE].
- 2) Press the <ENTER> button.
 - Press the <RETURN> button to release.

Note

- The power indicator <ON (G)/STANDBY (R)> flashes slowly when the projector is in AV mute mode.

[PROJECTOR SETUP] menu

On the menu screen, select [PROJECTOR SETUP] from the main menu, and select the item from the sub-menu.

Refer to “Navigating through the menu” (➔ page 42) for the operation of the menu screen.

- After selecting the item, press ▲▼◀▶ to set.

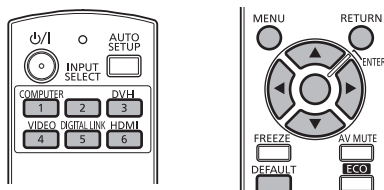

[PROJECTOR ID]

The projector has an ID number setting function that can be used when multiple projectors are used side by side to enable simultaneous control or individual control via one remote control.

1) Press ▲▼ to select [PROJECTOR ID].

2) Press ◀▶ to switch [PROJECTOR ID].

- The items will switch each time you press the button.

[ALL]	Set when controlling without specifying an ID number.
[1] - [6]	Set when specifying and controlling an individual ID number.

Note

- The ID number can be set to [ALL], or from [1] to [6].
- To specify an ID number for individual control, the ID number of a remote control must match the ID number of the projector.
- When the ID number is set to [ALL], the projector will operate regardless of the ID number specified during remote control or computer control.
If multiple projectors are set up side by side with IDs set to [ALL], they cannot be controlled separately from the projectors with other ID numbers.
- Refer to “Setting the remote control ID numbers” (➔ page 23) regarding the method to set the ID number on the remote control.

[PROJECTION METHOD]

Set the projection method in accordance with the installation status of the projector.

Change the projection method if the screen display is upside down or inverted.

1) Press ▲▼ to select [PROJECTION METHOD].

2) Press the <ENTER> button.

- The [PROJECTION METHOD] screen is displayed.

3) Press ▲▼ to select the projection method.

[FRONT/FLOOR]	When installing on the desk, etc., in front of the screen
[FRONT/CEILING]	When installing using the ceiling mount bracket (optional accessories) in front of the screen
[REAR/FLOOR]	When installing on the desk, etc., behind the screen (using a translucent screen)
[REAR/CEILING]	When installing using the ceiling mount bracket (optional accessories) behind the screen (using a translucent screen)

4) Press the <ENTER> button.

5) When the confirmation is displayed, select [OK] or [CANCEL], and press the <ENTER> button.

Attention

- When [PROJECTION METHOD] is changed, confirm that [COOLING CONDITION] (➔ page 71) is set correctly.

[COOLING CONDITION]

Change the fan control depending on the direction of projection.

Set [COOLING CONDITION] correctly in accordance with the direction of projection referencing the following figure. Using the light source with incorrect settings may shorten its life.

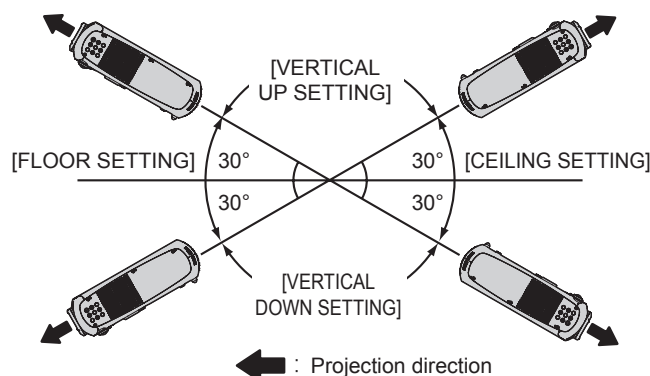

- 1) Press **▲▼** to select [COOLING CONDITION].
- 2) Press the **<ENTER>** button.
 - The [COOLING CONDITION] screen is displayed.
- 3) Press **▲▼** to select a cooling condition.
- 4) Press the **<ENTER>** button.
- 5) When the confirmation is displayed, select [OK] or [CANCEL], and press the **<ENTER>** button.

[HIGH ALTITUDE MODE]

Set to [ON] when using the projector at high altitudes between 1 400 m (4 593') and 2 700 m (8 858') above sea level.

- 1) Press **▲▼** to select [HIGH ALTITUDE MODE].
- 2) Press **◀▶** to switch the item.

[OFF]	When using at a location lower than 1 400 m (4 593') above sea level
[ON]	When using at high altitudes (between 1 400 m (4 593') and 2 700 m (8 858') above sea level)

- 3) When the confirmation screen is displayed, press **◀▶** to select [OK] or [CANCEL], and press the **<ENTER>** button.

Note

- The speed of the fan increases and the operation sound becomes louder when set to [ON].

[ECO MANAGEMENT]

A function that optimizes the light source power to suit usage conditions to reduce power consumption.

Setting [LIGHT POWER]

- 1) Press **▲▼** to select [ECO MANAGEMENT].
- 2) Press the **<ENTER>** button.
 - The [ECO MANAGEMENT] screen is displayed.
- 3) Press **▲▼** to select [LIGHT POWER].
- 4) Press **◀▶** to switch [LIGHT POWER].
 - The items will switch each time you press the button.

[NORMAL]	Set when high luminance is required.
[ECO SAVE1]	Reduces average power by approximately 20 % compared to [NORMAL] without affecting the brightness.

[ECO SAVE2]	Reduces average power by approximately 30 % compared to [NORMAL] without affecting the brightness.
[LOW]	Set when high luminance is not required and you want to save more power.

Note

- The rate of reduction of power consumption when the eco save mode is set refers to the ratio of average power consumption when projecting a "Broadcast" video signal that complies with IEC62087.
- When [ECO SAVE1] and [ECO SAVE2] is set, the image may appear differently to [NORMAL].
- If you feel that the brightness has decreased with [ECO SAVE2], switching to [ECO SAVE1] may improve the image.
- When [LOW] is set, the operating noise can be reduced.
- When the VIDEO input is selected, [ECO SAVE1] and [ECO SAVE2] cannot be selected. When [ECO SAVE1] or [ECO SAVE2] is set while selecting other than VIDEO input, and when the VIDEO input is selected, [LOW] is set.
- When [PICTURE MODE] is [NATURAL] and [ECO SAVE1] or [ECO SAVE2] is selected, the projected image may not conform to sRGB standards.
- When [PICTURE MODE] is [REC709] and [ECO SAVE1] or [ECO SAVE2] is selected, the projected image may not conform to REC709 standards.
- When [PICTURE MODE] is [DICOM SIM.] and [ECO SAVE1] or [ECO SAVE2] is selected, the projected image may be displayed different from DICOM standards.

Setting [AUTO POWER SAVE]

Set whether to enable the three functions [AMBIENT LIGHT DETECTION], [SIGNAL DETECTION], and [AV MUTE DETECTION].

1) Press ▲▼ to select [ECO MANAGEMENT].

2) Press the <ENTER> button.

- The [ECO MANAGEMENT] screen is displayed.

3) Press ▲▼ to select [AUTO POWER SAVE].

4) Press ◀▶ to switch [AUTO POWER SAVE].

- The items will switch each time you press the button.

[ON]	Enables power-saving mode.
[OFF]	Disables power-saving mode.

5) Press ▲▼ to select [AMBIENT LIGHT DETECTION], [SIGNAL DETECTION], or [AV MUTE DETECTION].

[AMBIENT LIGHT DETECTION]	Adjust the light source power depending on the brightness of the location of the projector.
[SIGNAL DETECTION]	Reduce the power of the light source when there is no signal.
[AV MUTE DETECTION]	Reduce the power of the light source in AV mute mode.

6) Press ◀▶ to switch the setting of [AMBIENT LIGHT DETECTION], [SIGNAL DETECTION], or [AV MUTE DETECTION].

- The items will switch each time you press the button.

[ON]	Enables the setting.
[OFF]	Disables the setting.

Note

- When [AUTO POWER SAVE] is [OFF], [AMBIENT LIGHT DETECTION], [SIGNAL DETECTION], and [AV MUTE DETECTION] cannot be set.

Setting [NO SIGNAL SHUT-OFF]

A function that automatically switches the power source of the projector to standby if there is no input signal for a certain period of time. The time before switching to standby can be set.

1) Press ▲▼ to select [ECO MANAGEMENT].

2) Press the <ENTER> button.

- The [ECO MANAGEMENT] screen is displayed.

3) Press ▲▼ to select [NO SIGNAL SHUT-OFF].

4) Press ◀▶ to switch [NO SIGNAL SHUT-OFF].

- The items will switch each time you press the button.

[DISABLE]	Disables the no signal shut-off function.
[10MIN.] - [90MIN.]	Sets the time in 10-minute intervals.

Setting [STANDBY MODE]

Set the power consumption during the standby.

1) Press ▲▼ to select [ECO MANAGEMENT].

2) Press the <ENTER> button.

- The [ECO MANAGEMENT] screen is displayed.

3) Press ▲▼ to select [STANDBY MODE].

4) Press ◀▶ to switch [STANDBY MODE].

- The items will switch each time you press the button.

[ECO]	Use this setting to reduce power consumption during standby.
[NORMAL]	Use this setting to use the network function during standby.

Note

- When set to [ECO], network functions are not available during standby. Also, some RS-232C commands are not available. When set to [NORMAL], network functions are available during standby.
- If set to [ECO], there may be a delay in displaying when the power is turned on compared to when set to [NORMAL].

Setting [ECO LEVEL DISPLAY]

Display the power save level by the settings of [LIGHT POWER] and [AUTO POWER SAVE] as an illustration at the left bottom of the projection screen.

The more the number of green Leaf mark (🍃), the more the power of the projector is saved.

Screen display example:



1) Press ▲▼ to select [ECO MANAGEMENT].

2) Press the <ENTER> button.

- The [ECO MANAGEMENT] screen is displayed.

3) Press ▲▼ to select [ECO LEVEL DISPLAY].

4) Press ◀▶ to switch [ECO LEVEL DISPLAY].

- The items will switch each time you press the button.

[OFF]	Disables the ECO level display.
[ON]	Enables the ECO level display.

Note

- If a closed caption signal of the selected mode is input, the ECO level is not displayed.
- The ECO level is not displayed when the menu screen is displayed.

[SCHEDULE]

Set the command execution schedule for each day of the week.

Enabling/disabling the schedule function

1) Press ▲▼ to select [SCHEDULE].

2) Press ◀▶ to switch [SCHEDULE].

- The items will switch each time you press the button.

[OFF]	Disables the schedule function.
-------	---------------------------------

[ON]	Enables the schedule function. Refer to “How to assign a program” (➡ page 74) or “How to set a program” (➡ page 74) for how to set the schedule.
------	--

Note

- When [SCHEDULE] is set to [ON], the [STANDBY MODE] setting is forcibly switched to [NORMAL], and the setting cannot be changed. Even if [SCHEDULE] is then set to [OFF] when in this state, the setting of [STANDBY MODE] remains at [NORMAL].

How to assign a program

- 1) Press ▲▼ to select [SCHEDULE].
- 2) Press ◀▶ to select [ON], and press the <ENTER> button.
 - The [SCHEDULE] screen is displayed.
- 3) Select and assign program to each day of week.
 - Press ▲▼ to select the day of week, and press ◀▶ to select a program number.
 - You can set the program from No.1 to No.7. “- -” indicates that the program number has not been set yet.

How to set a program

You can set up to 16 commands to each program.

- 1) Press ▲▼ to select [SCHEDULE].
- 2) Press ◀▶ to select [ON], and press the <ENTER> button.
 - The [SCHEDULE] screen is displayed.
- 3) Press ▲▼ to select [PROGRAM EDIT].
- 4) Press ◀▶ to select a program number and then press the <ENTER> button.
- 5) Press ▲▼ to select a command number and press the <ENTER> button.
 - You can change the page using ◀▶.
- 6) Press ▲▼ to select [TIME], and press the <ENTER> button.
- 7) Press ◀▶ to select the hour and minute, press ▲▼ to set the time, and press the <ENTER> button.
- 8) Press ▲▼ to select [COMMAND].
- 9) Press ◀▶ to switch [COMMAND].
 - The items will switch each time you press the button.
 - For [COMMAND] where detailed settings are available, the settings configured in Step 11) are displayed.

[COMMAND]	[COMMAND] setting	Description
[POWER ON]	—	Switch on the projector.
[STANDBY]	—	Enters standby.
[AV MUTE]	[OFF]	Cancels the AV mute.
	[ON]	Turns off the video and audio.
[INPUT]	[COMPUTER]	Switches to COMPUTER input.
	[VIDEO]	Switches to VIDEO input.
	[DVI-I]	Switches to DVI-I input.
	[HDMI]	Switches to HDMI input.
	[DIGITAL LINK]	Sets the input to DIGITAL LINK.
[DIGITAL LINK INPUT]	[CURRENT]	Switches to DIGITAL LINK input with the currently selected connection. Can only be selected when [INPUT] is set to [DIGITAL LINK].
	[INPUT1] - [INPUT10]*1	Switches to DIGITAL LINK input, and that input switches to specified input when the Panasonic twisted-pair-cable transmitter is connected. Can only be selected when [INPUT] is set to [DIGITAL LINK].

[COMMAND]	[COMMAND] setting	Description
[LIGHT POWER]	[NORMAL]	Prioritizes luminance.
	[ECO SAVE1]	Reduces average power by approximately 20 % compared to [NORMAL] without affecting the brightness.
	[ECO SAVE2]	Reduces average power by approximately 30 % compared to [NORMAL] without affecting the brightness.
	[LOW]	Saves more power and reduces luminance.
[IN STANDBY MODE(AUDIO)]	[OFF]	Turns off audio output during standby.
	[ON]	Turns on audio output during standby.
[VOLUME]	[0] - [63]	Sets the volume.

*1 When the Panasonic twisted-pair-cable transmitter (such as optional digital interface box (Model No.: ET-YFB100G)) is connected to the projector, its input name is reflected to [INPUT1] to [INPUT10] automatically. If an item where the input name is not reflected is selected, it is disabled.

10) Press the <ENTER> button.

- The [COMMAND] detailed screen is displayed.

11) Press ▲▼ to select a [COMMAND] setting.

- For [COMMAND] which requires detailed settings, the items of the detailed settings will switch each time you press ◀▶.

12) Press the <ENTER> button.

- The command is fixed and ● is displayed at the left of the selected command.
- After the command is fixed, press the <RETURN> button or the <MENU> button to close the detailed setting menu.

13) Press ▲▼ to select [STORE], and press the <ENTER> button.

Note

- When deleting commands that have already been set, press the <DEFAULT> button on the screen displayed in step 5).
- If multiple commands have been set for the same time, they are executed in chronological order starting from the smallest command number.
- The operating time will be the local time. (➡ page 80)
- If an operation is executed with the remote control or control panel of the projector or with a control command before the command set in [SCHEDULE] is executed, the command set with this function may not be executed.

[INITIAL STARTUP]

Set the start up method when the <MAIN POWER> switch is set to <ON>.

1) Press ▲▼ to select [INITIAL STARTUP].

2) Press ◀▶ to switch [INITIAL STARTUP].

- The items will switch each time you press the button.

[LAST MEMORY]	Starts the projector in the condition before the <MAIN POWER> switch was turned <OFF>.
[STANDBY]	Starts in standby.
[ON]	Starts projecting immediately.

[STARTUP INPUT SELECT]

Set the input when the projector is switched on to start projection.

1) Press ▲▼ to select [STARTUP INPUT SELECT].

2) Press ◀▶ to switch [STARTUP INPUT SELECT].

- The items will switch each time you press the button.

[LAST USED]	Keeps the input selected last.
[COMPUTER]	Sets the input to COMPUTER.
[VIDEO]	Sets the input to VIDEO.
[DVI-I]	Sets the input to DVI-I.
[HDMI]	Sets the input to HDMI.
[DIGITAL LINK]	Sets the input to DIGITAL LINK.

[DIGITAL LINK INPUT]

Can only be selected when [STARTUP INPUT SELECT] is set to [DIGITAL LINK].

1) Press ▲▼ to select [DIGITAL LINK INPUT].

2) Press ◀▶ to switch [DIGITAL LINK INPUT].

- The items will switch each time you press the button.

[CURRENT]	Switches to DIGITAL LINK input.
[INPUT1]	Switches to DIGITAL LINK input, and that input switches to specified input when the Panasonic twisted-pair-cable transmitter is connected.
[INPUT2]	
[INPUT3]	
[INPUT4]	
[INPUT5]	
[INPUT6]	
[INPUT7]	
[INPUT8]	
[INPUT9]	
[INPUT10]	

Note

- When the Panasonic twisted-pair-cable transmitter (such as optional digital interface box (Model No.: ET-YFB100G)) is connected to the projector, its input name is reflected to [INPUT1] to [INPUT10] automatically. If an item where the input name is not reflected is selected, it is disabled.

[RS-232C]

Set the sending and receiving port of the serial command.

Communicating using the <SERIAL IN> terminal

1) Press ▲▼ to select [RS-232C].

2) Press the <ENTER> button.

- The [RS-232C] screen is displayed.

3) Press ▲▼ to select [INPUT SELECT].

4) Press ◀▶ to switch [SERIAL].

5) Press ▲▼ to select [BAUDRATE].

6) Press ◀▶ to switch [BAUDRATE].

- The items will switch each time you press the button.

[9600]	Select the proper speed.
[19200]	
[38400]	

7) Press ▲▼ to select [PARITY].

8) Press ◀▶ to switch [PARITY].

- The items will switch each time you press the button.

[NONE]	Select the parity condition.
[EVEN]	
[ODD]	

Communicating using the <DIGITAL LINK/LAN> terminal

- 1) Press ▲▼ to select [RS-232C].
- 2) Press the <ENTER> button.
 - The [RS-232C] screen is displayed.
- 3) Press ▲▼ to select [INPUT SELECT].
- 4) Press ◀▶ to switch [DIGITAL LINK].
- 5) Press ▲▼ to select [PARITY].
- 6) Press ◀▶ to switch [PARITY].
 - The items will switch each time you press the button.

[NONE]	Select the parity condition.
[EVEN]	
[ODD]	

Using existing projector control commands

Set each item when controlling the projector from a computer with control commands of the previously purchased Panasonic projector. Existing Panasonic projector control software and other software can still be used.

- 1) Press ▲▼ to select [RS-232C].
- 2) Press the <ENTER> button.
 - The [RS-232C] screen is displayed.
- 3) Press ▲▼ to select [EMULATE].
- 4) Press the <ENTER> button.
- 5) Press ▲▼ to select an item.

[DEFAULT]	RZ370 series, RW330 series
[D3500]	D3500 series
[D4000]	D4000 series
[D/W5k SERIES]	D5700 series, DW5100 series, D5600 series, DW5000 series, D5500 series
[D/W/Z6k SERIES]	DZ770 series, DW740 series, DX810 series, DW730 series, DX800 series, DZ6710 series, DZ6700 series, DW6300 series, D6000 series, D5000 series, DZ570 series, DW530 series, DX500 series
[L730 SERIES]	L730 series, L720 series, L520 series
[L780 SERIES]	L780 series, L750 series
[L735 SERIES]	L735 series
[L785 SERIES]	L785 series
[F/W SERIES]	FW430 series, FX400 series, FW300 series, F300 series, F200 series, FW100 series, F100 series
[LZ370]	LZ370 series
[LB/W SERIES]	LB3 series, LB2 series, LB1 series, ST10 series, LB90 series, LW80NT series, LB80 series, LB78 series, LB75 series
[VX500 SERIES]	VW435N series, VW430 series, VX505N series, VX500 series, VW330 series, VX400NT series, VX400 series, VX41 series
[EZ570 SERIES]	EZ570 series, EW630 series, EW530 series, EX600 series, EX500 series
[VW431D]	VW431D series

- 6) Press the <ENTER> button.
- 7) When the confirmation is displayed, select [OK] or [CANCEL], and press the <ENTER> button.

Note

- Refer to “<SERIAL IN> terminal” (➔ page 119).
- When [DIGITAL LINK] is selected, communication is only available using the serial terminal when the relevant device (such as an optional digital interface box (Model No.: ET-YFB100G)) is connected to the <DIGITAL LINK/LAN> terminal.
- When transferring logos via the optional digital interface box (Model No.: ET-YFB100G), “NO SIGNAL SLEEP” of ET-YFB100G must be set to “OFF” to avoid cutting off communication.
- When [DIGITAL LINK] is selected, communication speed is fixed to 9 600 bps.

[FUNCTION BUTTON]

Displays the functions that are currently assigned to the <FUNC1> - <FUNC3> buttons on the remote control. Also, cancel the assigned settings.

Canceling the assigned settings of the <FUNC1> - <FUNC3> buttons

- 1) Press ▲▼ to select [FUNCTION BUTTON].
- 2) Press the <ENTER> button.
 - The [FUNCTION BUTTON] screen is displayed.
- 3) Press ▲▼ to select the function button (F1 - F3) where to cancel the assignment.
- 4) Press the <DEFAULT> button on the remote control.
- 5) When the confirmation is displayed, select [OK] and press the <ENTER> button.

Note

- You can also cancel the assigned settings by displaying the on-screen menu, selecting the menu item to be canceled (main menu, sub-menu, or details menu), and then pressing any one of the corresponding <FUNC1> - <FUNC3> buttons for at least three seconds.

[AUDIO SETTING]

Sets advanced audio functions.

Adjusting the volume

- 1) Press ▲▼ to select [AUDIO SETTING].
- 2) Press the <ENTER> button.
 - The [AUDIO SETTING] screen is displayed.
- 3) Press ▲▼ to select [VOLUME].
- 4) Press ◀▶ to adjust the level.

Operation	Adjustment	Range
Press the ▶ button.	The volume increases.	Maximum value 63
Press the ◀ button.	The volume decreases.	Minimum value 0

Adjusting the left/right audio balance

- 1) Press ▲▼ to select [AUDIO SETTING].
- 2) Press the <ENTER> button.
 - The [AUDIO SETTING] screen is displayed.
- 3) Press ▲▼ to select [BALANCE].
- 4) Press ◀▶ to adjust the level.

Operation	Adjustment	Range
Press the ▶ button.	The right volume increases.	L16 - R16
Press the ◀ button.	The left volume increases.	

Setting the audio output during standby

- 1) Press ▲▼ to select [AUDIO SETTING].
- 2) Press the <ENTER> button.
 - The [AUDIO SETTING] screen is displayed.
- 3) Press ▲▼ to select [IN STANDBY MODE].
- 4) Press ◀▶ to switch [IN STANDBY MODE].
 - The items will switch each time you press the button.

[OFF]	Turns off audio output during standby.
[ON]	Turns on audio output during standby.

Note

- When [STANDBY MODE] (▶ page 73) of [ECO MANAGEMENT] is set to [ECO], audio cannot be output during standby.
- The projector has no built-in speakers.
Audio can be output via external audio systems connected to the audio output terminal.

Setting audio input when HDMI input is selected

- 1) Press ▲▼ to select [AUDIO SETTING].
- 2) Press the <ENTER> button.
 - The [AUDIO SETTING] screen is displayed.
- 3) Press ▲▼ to select [HDMI].
- 4) Press ◀▶ to switch [HDMI].
 - The items will switch each time you press the button.

[HDMI AUDIO]	Outputs HDMI audio.
[AUDIO IN]	Outputs audio connected via the <AUDIO IN> terminal.

Note

- If COMPUTER, DVI-I, or VIDEO input is selected, audio connected to the <AUDIO IN> terminal is output.

Setting audio input when DIGITAL LINK input is selected

- 1) Press ▲▼ to select [AUDIO SETTING].
- 2) Press the <ENTER> button.
 - The [AUDIO SETTING] screen is displayed.
- 3) Press ▲▼ to select [DIGITAL LINK].
- 4) Press ◀▶ to switch [DIGITAL LINK].
 - The items will switch each time you press the button.

[DIGITAL LINK AUDIO]	Outputs DIGITAL LINK audio.
[AUDIO IN]	Outputs audio connected via the <AUDIO IN> terminal.

Note

- If COMPUTER, DVI-I, or VIDEO input is selected, audio connected to the <AUDIO IN> terminal is output.

[STATUS]

Displays the status of the projector.

- 1) Press ▲▼ to select [STATUS].
- 2) Press the <ENTER> button.
 - The [STATUS] screen is displayed.
- 3) Press ◀▶ to switch the pages.
 - The page will change each time you press the button.

[INPUT]	Displays the input terminal currently selected.
[SIGNAL NAME]	Displays the input signal name.
[SIGNAL FREQUENCY]	Displays the frequency of the input signal.
[PROJECTOR RUNTIME]	Displays the operation times of the projector.
[INTAKE AIR TEMP.]	Displays the status of the air intake temperature of the projector.
[OPTICS MODULE TEMP.]	Displays the status of the internal temperature of the projector.
[NUMBER OF ENTRY SIGNAL]	Displays the number of registered signals.
[EMULATE]	Displays the [EMULATE] settings.
[PROJECTOR TYPE]	Displays the type of the projector.
[SERIAL NUMBER]	Displays the serial number of the projector.
[MAIN VERSION]	Displays the main version of the firmware of the projector.
[SUB VERSION]	Displays the sub version of the firmware of the projector.
[NETWORK VERSION]	Displays the network version of the projector.

Note

- The content of status can be sent via E-mail by pressing the <ENTER> button while displaying the status.

[DATE AND TIME]

Set the time zone, date, and time of the built-in clock of the projector.

Setting time zone

- 1) Press ▲▼ to select [DATE AND TIME].
- 2) Press the <ENTER> button.
 - The [DATE AND TIME] screen is displayed.
- 3) Press ▲▼ to select [TIME ZONE].
- 4) Press ◀▶ to switch [TIME ZONE].

Setting the date and time manually

- 1) Press ▲▼ to select [DATE AND TIME].
- 2) Press the <ENTER> button.
 - The [DATE AND TIME] screen is displayed.
- 3) Press ▲▼ to select [ADJUST CLOCK].
- 4) Press the <ENTER> button.
 - The [ADJUST CLOCK] screen is displayed.
- 5) Press ▲▼ to select an item, and press ◀▶ to set the local date and time.
- 6) Press ▲▼ to select [APPLY], and press the <ENTER> button.
 - The setting of the time will be completed.

Setting the date and time automatically

- 1) Press ▲▼ to select [DATE AND TIME].
- 2) Press the <ENTER> button.
 - The [DATE AND TIME] screen is displayed.
- 3) Press ▲▼ to select [ADJUST CLOCK].
- 4) Press the <ENTER> button.
 - The [ADJUST CLOCK] screen is displayed.
- 5) Press ▲▼ to select [NTP SYNCHRONIZATION], and press ◀▶ to change the setting to [ON].
 - The items will switch each time you press the button.

[OFF]	Disables [NTP SYNCHRONIZATION].
[ON]	Enables [NTP SYNCHRONIZATION].

- 6) Press ▲▼ to select [APPLY], and press the <ENTER> button.
 - The setting of the time will be completed.

Note

- To set the date and time automatically, the projector must be connected to the network.
- If synchronization with the NTP server fails just after [NTP SYNCHRONIZATION] is turned [ON], or if [NTP SYNCHRONIZATION] is turned [ON] while the NTP server is not set, [NTP SYNCHRONIZATION] will return to [OFF].
- Access the projector via the web browser to set the NTP server. Refer to “[Adjust clock] page” (▶ page 99) for details.

[SAVE ALL USER DATA]

Save the various setting values as a backup in the built-in memory of the projector.

- 1) Press ▲▼ to select [SAVE ALL USER DATA].
- 2) Press the <ENTER> button.
 - The [SECURITY PASSWORD] screen is displayed.
- 3) Enter a security password and press the <ENTER> button.
- 4) When the confirmation is displayed, select [OK] or [CANCEL], and press the <ENTER> button.
 - [PROGRESS] is displayed while saving data.

Note

- The image setting registered in [USER LOGO] is not saved.

[LOAD ALL USER DATA]

Load the various setting values saved as a backup in the built-in memory of the projector.

- 1) Press ▲▼ to select [LOAD ALL USER DATA].
- 2) Press the <ENTER> button.
 - The [SECURITY PASSWORD] screen is displayed.
- 3) Enter a security password and press the <ENTER> button.
- 4) When the confirmation is displayed, select [OK] or [CANCEL], and press the <ENTER> button.

Note

- The projector will go into the standby status to reflect the setting values when [LOAD ALL USER DATA] is executed.

[INITIALIZE]

Return various setting values to their factory default settings.

- 1) Press ▲▼ to select [INITIALIZE].
- 2) Press the <ENTER> button.
 - The [SECURITY PASSWORD] screen is displayed.
- 3) Enter a security password and press the <ENTER> button.
 - The [INITIALIZE] screen is displayed.
- 4) Press ▲▼ to select an item to initialize.

[ALL USER DATA]	Returns all setting items including [ENTRY SIGNAL], [NETWORK SETUP], [E-mail set up], and [USER LOGO] to factory default values. The projector will go into the standby status to reflect the setting values.
[ENTRY SIGNAL]	Deletes all the setting values saved for each input signal. To delete only a part of a registered signal, perform the procedure described in “Deleting the registered data” (➔ page 85).
[NETWORK/E-MAIL]	Returns [NETWORK SETUP] and [E-mail set up] to factory default settings.
[LOGO IMAGE]	Deletes the image registered in [USER LOGO].

- 5) Press the <ENTER> button.
- 6) When the confirmation is displayed, select [OK] or [CANCEL], and press the <ENTER> button.

[SERVICE PASSWORD]

Used by a service person.

[TEST PATTERN] menu

- On the menu screen, select [TEST PATTERN] from the main menu.
Refer to “Navigating through the menu” (▶ page 42) for the operation of the menu screen.
- Press ◀▶ to switch.

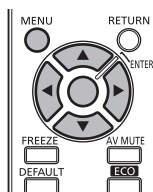

[TEST PATTERN]

Display the test pattern built-in to the projector.

Settings of position, size, and other factors will not be reflected in test patterns. Make sure to display the input signal before performing various adjustments.

1) Press ◀▶ to switch [TEST PATTERN].

- The items will switch each time you press the button.

Menu screen + All white	
Menu screen + All black	
Menu screen + Window	
Menu screen + Window (inversion)	
Menu screen + Color bar (vertical)	Displays test patterns with the menu screen. Select a test pattern so that it is easy to make various adjustments.
Menu screen + Color bar (horizontal)	
Menu screen + 16:9/4:3 aspect frame	
Menu screen + Focus	
Menu screen + Entry screen	Displays the menu screen and input signal. Displays internal test patterns.

Note

- Press the <MENU> button on the remote control while the test pattern is displayed to hide the on-screen menu.
- If the on-screen display is hidden while displaying the test pattern, the test pattern is not switched even if ◀▶ are pressed. To switch the test pattern, operate with the on-screen displayed.

[SIGNAL LIST] menu

On the menu screen, select [SIGNAL LIST] from the main menu.
Refer to “Navigating through the menu” (➔ page 42) for the operation of the menu screen.

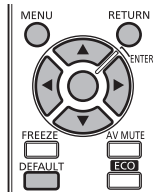

■ Registered signal details

- A name can be set for each sub memory (➔ page 68).
- Memory number:

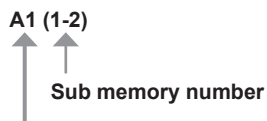

When the signal of the address number (A1, A2, ... L7, L8) is registered

Registering a signal to the list

After a new signal is input and the <MENU> button on the remote control or the control panel is pressed, the registration is completed and the [MAIN MENU] screen is displayed.

Note

- Up to 96 signals, including sub memories, can be registered to the projector.
- There are 12 pages (eight memories of A through L, with eight memories possible on each page) for memory numbers, and it is registered to the lowest number that is available. If there is no available memory number it will be overwritten from the oldest signal.
- The names to be registered are automatically determined by the input signals and memory numbers.
- If a menu is being displayed, the new signals will be registered at the instant they are input.

Renaming the registered signal

Registered signals can be renamed.

- 1) Press ▲▼◀▶ to select the signal for which details are to be displayed.
- 2) Press the <ENTER> button.
 - The [REGISTERED SIGNAL STATUS] screen is displayed.
 - The input signal name, memory number, input terminal, frequency, synchronization signal, etc., are displayed.
 - Press the <RETURN> button or the <MENU> button to return to the [REGISTERED SIGNAL LIST] screen.
- 3) Press the <ENTER> button.
 - The [RENAME] screen is displayed.
- 4) Press ▲▼◀▶ to select the text, and press the <ENTER> button to enter the text.
- 5) After the name is changed, press ▲▼◀▶ to select [OK], and press the <ENTER> button.
 - The registration is completed and the [REGISTERED SIGNAL STATUS] screen returns.
 - When pressing ▲▼◀▶ to select [CANCEL] and pressing the <ENTER> button, the changed signal name will not be registered and an automatically registered signal name will be used.

Deleting the registered data

Registered signals can be deleted.

1) Press ▲▼◀▶ to select the signal to delete.

2) Press the <DEFAULT> button.

- The [ENTRY SIGNAL DELETE] screen is displayed.
- To cancel the deletion, press the <RETURN> button or the <MENU> button to return to the [REGISTERED SIGNAL LIST] screen.

3) Press the <ENTER> button.

- The selected signal will be deleted.

[SECURITY] menu

On the menu screen, select [SECURITY] from the main menu, and select the item from the sub-menu.

Refer to “Navigating through the menu” (➔ page 42) for the operation of the menu screen.

- When the projector is used for the first time
Initial password: Press ▲▶▼◀▲▶▼◀ in order, and press the <ENTER> button.
- After selecting the item, press ▲▶▼◀ to set.

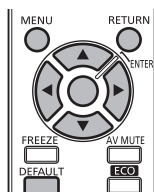

Attention

- When you select the [SECURITY] from the main menu and press the <ENTER> button, entering a password is required. Enter the set password and then continue operations of the [SECURITY] menu.
- When the password has been changed previously, enter the changed password, and press the <ENTER> button.

Note

- The entered password is displayed with * mark on the screen.
- An error message is displayed on the screen when the entered password is incorrect. Re-enter the correct password.

[SECURITY PASSWORD]

The [SECURITY PASSWORD] screen is displayed when the power is turned on. If an incorrect password has been entered, operations other than the power <⏻/> button or the <AV MUTE> button are not available.

- 1) Press ▲▼ to select [SECURITY PASSWORD].
- 2) Press ◀▶ to switch [SECURITY PASSWORD].

- The items will switch each time you press the button.

[OFF]	Disables the security password entry.
[ON]	Enables the security password entry.

Note

- The [SECURITY PASSWORD] setting is set to [OFF] at the time of purchase or when all the user data has been initialized.
- Change the password periodically that is hard to guess.
- The security password is enabled after setting [SECURITY PASSWORD] to [ON] and turning the <MAIN POWER> switch to <OFF>.

[SECURITY PASSWORD CHANGE]

Change the security password.

- 1) Press ▲▼ to select [SECURITY PASSWORD CHANGE].
- 2) Press the <ENTER> button.
 - The [SECURITY PASSWORD CHANGE] screen is displayed.
- 3) Press ▲▶▼◀ and the number (<1> - <6>) buttons to set the password.
 - Up to eight button operations can be set.
- 4) Press the <ENTER> button.
- 5) Re-enter the password for the confirmation.
- 6) Press the <ENTER> button.

Note

- The entered password is displayed with * mark on the screen.
- If numbers have been used for the security password, the security password will need to be initialized again if the remote control is lost. Consult your dealer for the initialization method.

[TEXT DISPLAY]

Overlap the security message (text) over the projecting image.

1) Press ▲▼ to select [TEXT DISPLAY].

2) Press ◀▶ to switch [TEXT DISPLAY].

- The items will switch each time you press the button.

[OFF]	Hides the security message.
[ON]	Displays the security message.

Note

- If a closed caption signal of the selected mode is input, the security message is not displayed.

[TEXT CHANGE]

Change the text displayed when [TEXT DISPLAY] is set to [ON].

1) Press ▲▼ to select [TEXT CHANGE].

2) Press the <ENTER> button.

- The [TEXT CHANGE] screen is displayed.

3) Press ▲▼◀▶ to select the text, and press the <ENTER> button to enter the text.

- Maximum 22 characters can be input.

4) Press ▲▼◀▶ to select [OK], and press the <ENTER> button.

- The text is changed.

[MENU LOCK]

Display the menu with the <MENU> button, and set whether to enable menu operations.

1) Press ▲▼ to select [MENU LOCK].

2) Press ◀▶ to switch [MENU LOCK].

- The items will switch each time you press the button.

[OFF]	Cancels the lock on menu operations.
[ON]	Locks menu operations.

Note

- After setting [MENU LOCK] to [ON], if the wrong password is input, the <MENU> button cannot be operated.
- At the time of purchase or after [ALL USER DATA] initialization, [MENU LOCK] is set to [OFF].
- The lock release is maintained until the projector enters standby.

[MENU LOCK PASSWORD]

Change the menu lock password.

1) Press ▲▼ to select [MENU LOCK PASSWORD].

2) Press the <ENTER> button.

- The [MENU LOCK PASSWORD] screen is displayed.

3) Press ▲▼◀▶ to select the text, and press the <ENTER> button to enter the text.

- Maximum 16 characters can be input.

4) Press ▲▼◀▶ to select [OK], and press the <ENTER> button.

- To cancel, select [CANCEL].

Attention

- The initial password when used for the first time or after initializing all the user data is "AAAA".
- Change the password periodically that is hard to guess.

[CONTROL DEVICE SETUP]

Enable/disable the button operations on the control panel and the remote control.

- 1) Press ▲▼ to select [CONTROL DEVICE SETUP].
- 2) Press the <ENTER> button.
 - The [CONTROL DEVICE SETUP] screen is displayed.
- 3) Press ▲▼ to select [CONTROL PANEL] or [REMOTE CONTROL].
- 4) Press the <ENTER> button.
 - The [CONTROL PANEL] screen or the [REMOTE CONTROL] screen is displayed.
- 5) Press ▲▼ to select [ENABLE] or [DISABLE].
 - You can set the limitation on the control from the control panel and remote control.

[ENABLE]	Enables all button operations on the projector body and remote control.
[DISABLE]	Disables all button operations on the projector body and remote control.

- 6) Press the <ENTER> button.
- 7) When the confirmation is displayed, select [OK] or [CANCEL], and press the <ENTER> button.

Note

- When a button operation is performed on the device set to [DISABLE], the [SECURITY PASSWORD] screen is displayed. To continue operations, enter the security password.
- The [SECURITY PASSWORD] screen will disappear when the <MENU> button is pressed, or when there is no operation for approximately ten seconds.
- If the operations of both [CONTROL PANEL] and [REMOTE CONTROL] are set to [DISABLE], the projector cannot be turned off (cannot enter standby).
- When the setting has completed, the menu screen will disappear. To operate continuously, press the <MENU> button to display the main menu.

[NETWORK] menu

On the menu screen, select [NETWORK] from the main menu, and select the item from the sub-menu.

Refer to “Navigating through the menu” (→ page 42) for the operation of the menu screen.

- After selecting the item, press ▲▼◀▶ to set.

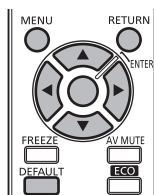

[DIGITAL LINK MODE]

Switch the communication method of the <DIGITAL LINK/LAN> terminal of the projector.

1) Press ▲▼ to select [DIGITAL LINK MODE].

2) Press ◀▶ to switch [DIGITAL LINK MODE].

- The items will switch each time you press the button.

[AUTO]	Switches the communication method automatically between either the DIGITAL LINK or Ethernet.
[DIGITAL LINK]	Fixes the communication method to DIGITAL LINK.
[ETHERNET]	Fixes the communication method to Ethernet.

Possible communication modes

Setting		Communication possible		
		HDMI	Ethernet	RS-232C
[AUTO]	For DIGITAL LINK	✓	✓	✓
	With Ethernet	—	✓	—
[DIGITAL LINK]		✓	✓	✓
[ETHERNET]		—	✓	—

✓: Communication possible

—: Communication not possible

[DIGITAL LINK SETUP]

Set the communication method to DIGITAL LINK.

When the projector is connected directly via Ethernet

1) Press ▲▼ to select [DIGITAL LINK SETUP].

2) Press the <ENTER> button.

- The [DIGITAL LINK SETUP] screen is displayed.

3) Press ▲▼ to select [DUPLEX(ETHERNET)].

4) Press ◀▶ to switch the communication method.

- The items will switch each time you press the button.

[AUTONEGOTIATION]	The communication method is set automatically.
[100BaseTX-Full]	Full duplex communication method is set.
[100BaseTX-Half]	Half-duplex communication method is set.

5) Press ▲▼ to select [STORE].

6) Press the <ENTER> button.

7) When the confirmation is displayed, select [OK] or [CANCEL], and press the <ENTER> button.

Note

- Not compatible with 10BaseT Full/Half.

When the projector is connected directly via a twisted-pair-cable transmitter

- 1) Press ▲▼ to select [DIGITAL LINK SETUP].
- 2) Press the <ENTER> button.
 - The [DIGITAL LINK SETUP] screen is displayed.
- 3) Press ▲▼ to select [DUPLX(DIGITAL LINK)].
- 4) Press ◀▶ to switch the communication method.
 - The items will switch each time you press the button.

[100BaseTX-Full]	Full duplex communication method is set.
[100BaseTX-Half]	Half-duplex communication method is set.
[AUTONEGOTIATION]	The communication method is set automatically.

- 5) Press ▲▼ to select [STORE].
- 6) Press the <ENTER> button.
- 7) When the confirmation is displayed, select [OK] or [CANCEL], and press the <ENTER> button.

[DIGITAL LINK STATUS]

Display DIGITAL LINK connection environment.

- 1) Press ▲▼ to select [DIGITAL LINK STATUS].
- 2) Press the <ENTER> button.
 - The [DIGITAL LINK STATUS] screen is displayed.

[LINK STATUS]	Display [NO LINK], [DIGITAL LINK], or [ETHERNET].
[HDMI STATUS]	Display any one of [NO HDMI], [HDMI ON], or [HDCP ON].
[SIGNAL QUALITY]	<p>[SIGNAL QUALITY] is a numerical value of the amount of error, and the display color changes to green, yellow, or red depending on the value. Check the signal quality level while receiving a signal from the twisted-pair-cable transmitter.</p> <ul style="list-style-type: none"> • MAX/MIN: Maximum/minimum value of the amount of error. • Green (-12 dB or lower) → Normal signal quality level. • Yellow (-11 to -8 dB) → Warning level where there is the possibility of noise introduced on the screen. • Red (-7 dB or higher) → Abnormal level where synchronization may interrupted, or a signal may not be received.

[NETWORK SETUP]

Perform the initial setting of the network before using the network function.

- 1) Press ▲▼ to select [NETWORK SETUP].
- 2) Press the <ENTER> button.
 - The [NETWORK SETUP] screen is displayed.
- 3) Press ▲▼ to select an item, and change the settings according to the operation instructions of the menu.

[PROJECTOR NAME]	Change the setting when using a DHCP server.
[DHCP]	Set to [ON] when obtaining an IP address automatically using a DHCP server. Set to [OFF] when not using a DHCP server.
[IP ADDRESS]	Enter the IP address when not using a DHCP server.
[SUBNET MASK]	Enter the subnet mask when not using a DHCP server.
[DEFAULT GATEWAY]	Enter the default gateway address when not using a DHCP server.

- 4) Press ▲▼ to select [STORE], and press the <ENTER> button.
- 5) When the confirmation is displayed, select [OK] or [CANCEL], and press the <ENTER> button.

Note

- When using a DHCP server, confirm that the DHCP server is running.
- Consult your network administrator regarding the IP address, subnet mask, and default gateway.

[NETWORK CONTROL]

Set up the control method of the network.

- 1) Press ▲▼ to select [NETWORK CONTROL].
- 2) Press the <ENTER> button.
 - The [NETWORK CONTROL] screen is displayed.
- 3) Press ▲▼ to select an item, and press ◀▶ to change the setting.

[WEB CONTROL]	Set to [ON] to control with the web browser.
[PJLink CONTROL]	Set to [ON] to control with the PJLink protocol.
[COMMAND CONTROL]	Set to [ON] when controlling the projector with a <SERIAL IN> terminal control command format (➡ page 121). Refer to "Control commands via LAN" (➡ page 117).
[COMMAND PORT]	Set the port number used for command control.
[CRESTRON RoomView]	Set to [ON] to control with RoomView of Crestron.
[AMX D.D.]	Set to [ON] to control with the controller of AMX. Setting this function to on enables detection with AMX device discovery. For details, refer to the website of AMX. URL http://www.amx.com/
[EXTRON XTP]	Set to [ON] when connecting the "XTP transmitter" of Extron Electronics to the <DIGITAL LINK/LAN> terminal. [EXTRON XTP] must be set to [OFF] when connecting an optional digital interface box (Model No.: ET-YFB100G). For details of "XTP transmitter", refer to the website of Extron Electronics. URL http://www.extron.com/
[STORE]	Save the current network control settings.

- 4) Press ▲▼ to select [STORE], and press the <ENTER> button.
- 5) When the confirmation is displayed, select [OK] or [CANCEL], and press the <ENTER> button.

[NETWORK STATUS]

Display the status of the projector network.

1) Press ▲▼ to select [NETWORK STATUS].

2) Press the <ENTER> button.

- The [NETWORK STATUS] screen is displayed.

Network connections

The projector has a network function, and the following operations are available from the computer using the web control.

- Setting and adjustment of the projector
- Display of the projector status
- Sending of E-mail messages when there is a problem with the projector

The projector supports “Crestron RoomView” and the following application software of Crestron Electronics, Inc. can also be used.

- RoomView Express
- Fusion RV
- RoomView Server Edition

Attention

- Connect the LAN to indoor devices.

Note

- “Crestron RoomView” is system of Crestron Electronics, Inc. that manages and controls devices on multiple systems connected to a network collectively with a computer.
- For details of “Crestron RoomView”, refer to the website of Crestron Electronics, Inc. (English only)
URL <http://www.crestron.com>
For the download of “RoomView Express”, refer to the website of Crestron Electronics, Inc. (English only)
URL <http://www.crestron.com/getroomview>
- A LAN cable is required to use the network function.

■ Example of a normal network connection

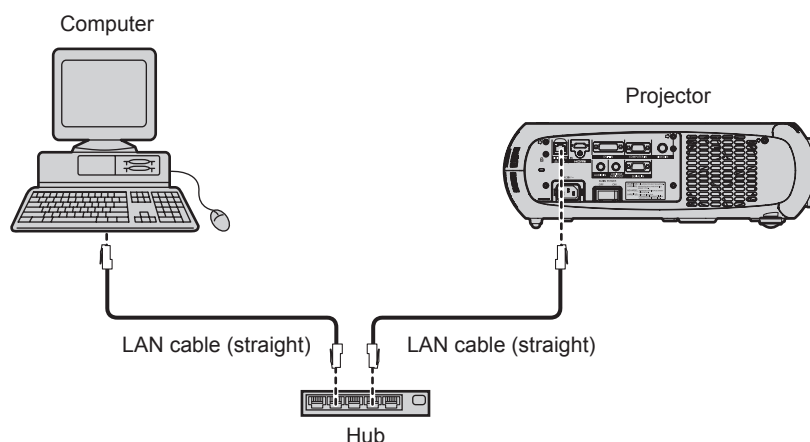

- The web browser is required to use this function. Confirm that the web browser can be used beforehand.
Compatible OS: Windows XP/Windows Vista/Windows 7, Mac OS X v10.4/v10.5/v10.6/v10.7/v10.8
Compatible browser: Internet Explorer 7.0/8.0/9.0, Safari 4.0/5.0/6.0 (Mac OS)
- Communication with an E-mail server is required to use the E-mail function. Confirm that the E-mail can be used beforehand.
- Use a LAN cable compatible with category 5 or higher.
- Use a LAN cable of 100 m (328'1") or shorter length.

Connecting to a twisted-pair-cable transmitter

The projector has a function that can receive Ethernet signals from a twisted-pair-cable transmitter together with video and audio signals via a LAN cable.

Connect a LAN cable to the <DIGITAL LINK/LAN> terminal of the projector. (➔ pages 16, 22)

■ Example of network connections via a twisted-pair-cable transmitter

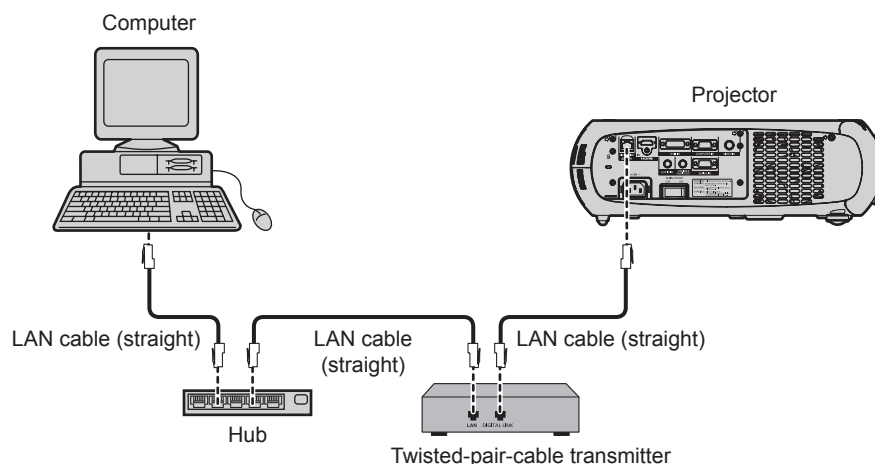

- For the LAN cable between a twisted-pair-cable transmitter and the projector, use a cable that meets the following criteria:
 - Compatible with CAT5e or higher
 - Shielded type (including connectors)
 - Straight-through
 - Single wire
- The maximum transmission distance between the twisted-pair-cable transmitter and the projector is 100 m (328'1"). If this distance is exceeded, image and sound may be disrupted and may cause a malfunction in LAN communication.
- When laying cables, check that cable characteristics are compatible with CAT5e or higher using tools such as a cable tester or cable analyzer.
 - When using a relay connector midway, include it in the measurement.
- Do not use a hub between a twisted-pair-cable transmitter and the projector.
- Do not pull cables forcefully. Also, do not bend or fold cables unnecessarily.
- To reduce noise, stretch out the cables between the twisted-pair-cable transmitter and the projector without any loops as much as possible before setting them up and using them.
- Lay the cables between a twisted-pair-cable transmitter and the projector away from other cables, particularly power cables.
- When installing multiple cables, run them side by side along the shortest distance possible without bundling them together.
- After laying the cables, confirm that the [SIGNAL QUALITY] value in the [NETWORK] menu → [DIGITAL LINK STATUS] is displayed in green to indicate normal quality. (➔ page 90)
- For twisted-pair-cable transmitter of other manufacturers of which the operation has been verified with the DIGITAL LINK compatible projector, refer to Panasonic website (<http://panasonic.net/avc/projector/>). Note that the verification for devices of other manufacturers has been made for the items set by Panasonic Corporation, and not all the operations have been verified. For operation or performance problems caused by the devices of other manufacturers, contact the respective manufacturers.

Accessing from the web browser

- 1) Start up the web browser on the computer.
- 2) Enter the IP address set on the projector into the URL entry field of the web browser.
- 3) Enter the user name and the password.
 - The factory default setting of the user name is user1 (user rights)/admin1 (administrator rights) and the password is panasonic (lower case).



- 4) Click OK.
 - The [Projector status] page is displayed.



Note

- If you use a web browser to control the projector, set [WEB CONTROL] to [ON] in [NETWORK CONTROL] (➔ page 91).
- Do not perform setting or control simultaneously by starting up multiple web browsers. Do not set or control the projector from multiple computers.
- Change the password first. (➔ page 104)
- The administrator rights allows to use all functions. The user rights allow use of [Projector status] (➔ page 95), confirmation of the error information page (➔ page 96), [Network status] (➔ page 96), [Basic control] (➔ page 97), [Advanced control] (➔ page 98), and [Change password] (➔ page 104), only.
- Access will be locked for a few minutes when an incorrect password is entered three times consecutively.
- Some items on the projector setting page use the Javascript function of the web browser. The projector may not be able to be controlled properly if it is set with a browser that does not have this function enabled.
- While updating the screen for the web control, the screen may become white for a moment, but it is not a malfunction.

Descriptions of items

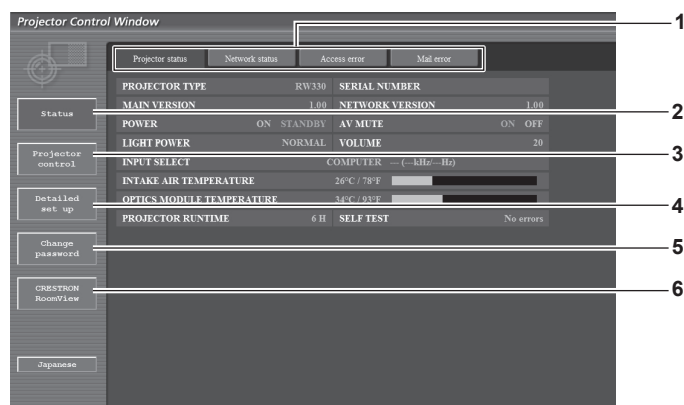

- | | |
|---|--|
| <p>1 [Page tab]
Switches pages by clicking it.</p> <p>2 [Status]
The status of the projector is displayed by clicking this item.</p> <p>3 [Projector control]
The [Projector control] page is displayed by clicking this item.</p> | <p>4 [Detailed set up]
The [Detailed set up] page is displayed by clicking this item.</p> <p>5 [Change password]
The [Change password] page is displayed by clicking this item.</p> <p>6 [CRESTRON RoomView]
The control page of RoomView is displayed by clicking this item.</p> |
|---|--|

[Projector status] page

Click [Status] → [Projector status].

Displays the status of the projector for the following items.

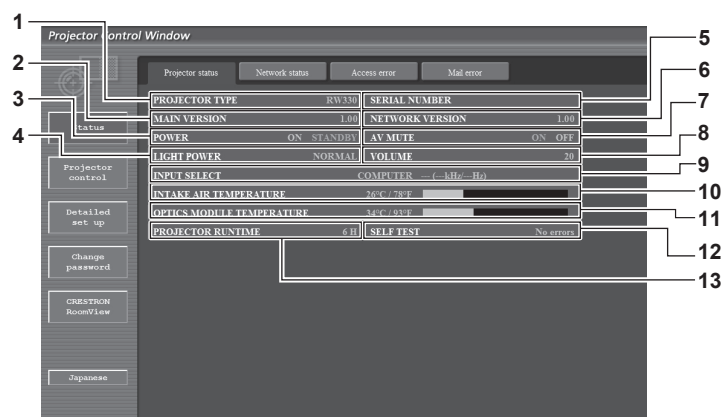

- | | |
|---|---|
| <p>1 [PROJECTOR TYPE]
Displays the type of the projector.</p> <p>2 [MAIN VERSION]
Displays the firmware version of the projector.</p> <p>3 [POWER]
Displays the status of the power.</p> <p>4 [LIGHT POWER]
Displays the setting status of [LIGHT POWER] (➡ page 71).</p> <p>5 [SERIAL NUMBER]
Displays the serial number of the projector.</p> <p>6 [NETWORK VERSION]
Displays the version of the firmware of the network.</p> <p>7 [AV MUTE]
Displays the AV mute status.</p> <p>8 [VOLUME]
Displays the volume status.</p> <p>9 [INPUT SELECT]
Displays the status of the input selection.</p> <p>10 [INTAKE AIR TEMPERATURE]
Displays the status of the air intake temperature of the projector.</p> <p>11 [OPTICS MODULE TEMPERATURE]
Displays the temperature status inside the projector.</p> <p>12 [SELF TEST]
Displays the self-diagnosis information.</p> | <p>13 [PROJECTOR RUNTIME]
Displays the operation times of the projector.</p> |
|---|---|

Error information page

When [Error (Detail)] is displayed in the self-diagnosis display of the [Projector status] screen, click it to display the error details.

- The projector may go into the standby status to protect the projector depending on the contents of the error.

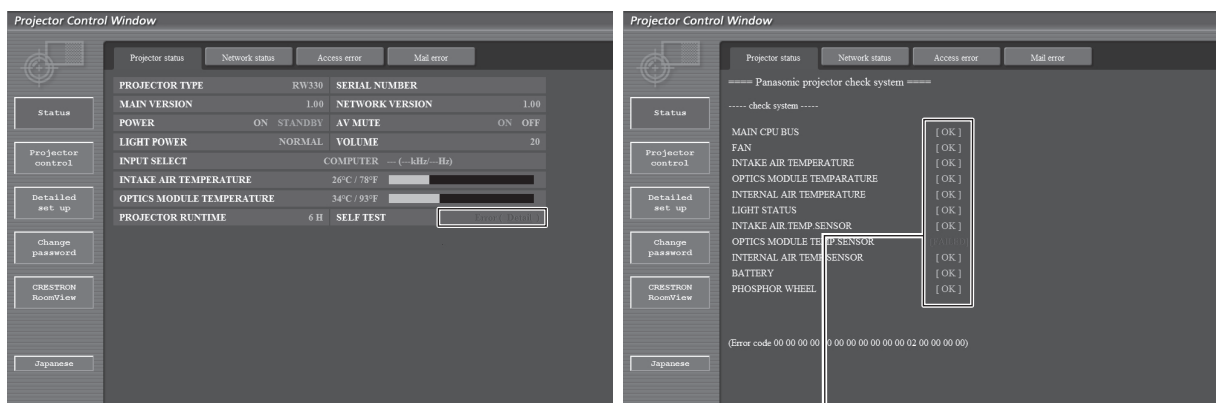

[OK]: Operating properly
 [FAILED]: A problem occurred
 [WARNING]: Warning

■ Problem occurrence [FAILED] items

Parameter	Description
[MAIN CPU BUS]	There is a problem with the microcomputer circuitry. Consult your dealer.
[FAN]	There is a problem with the fan or the fan drive circuit. Consult your dealer.
[INTAKE AIR TEMPERATURE]	The air intake temperature is too high. It may be used in an operating environment where the temperature is high, such as near a heating appliance.
[OPTICS MODULE TEMPERATURE]	The temperature around the optics module inside the projector is high. The projector may be used in an operating environment where the temperature is high, such as near a heating appliance.
[INTERNAL AIR TEMPERATURE]	The temperature inside the projector is high. It may be used in an operating environment where the temperature is high, such as near a heating appliance.
[LIGHT STATUS]	The light source failed to turn on or off. Wait a while until the light source cools off, and then turn on the power.
[INTAKE AIR TEMP.SENSOR]	There is a problem with the intake temperature detection sensor. Consult your dealer.
[OPTICS MODULE TEMP.SENSOR]	There is a problem with the temperature detection sensor around the optics module inside the projector. Consult your dealer.
[INTERNAL AIR TEMP.SENSOR]	There is a problem with the temperature detection sensor inside the projector. Consult your dealer.
[BATTERY]	Battery replacement is required. Consult your dealer.
[PHOSPHOR WHEEL]	There is a problem with the fluorescent wheel or fluorescent wheel drive circuit. Consult your dealer.

[Network status] page

Click [Status] → [Network status].

The current network setting status is displayed.

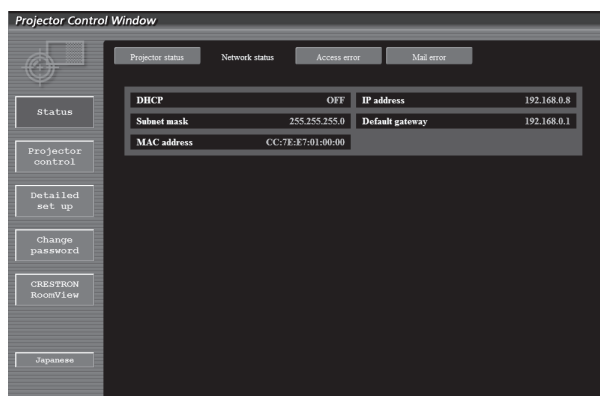

[Access error] page

Click [Status] → [Access error].

The error log on the WEB server is displayed such as access to the pages that do not exist or access with unauthorized user names or passwords.

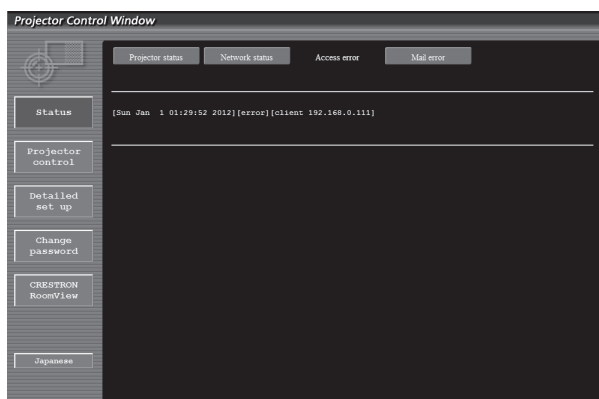

[Mail error] page

Click [Status] → [Mail error].

Displays email error information if the system fails to send periodic emails.

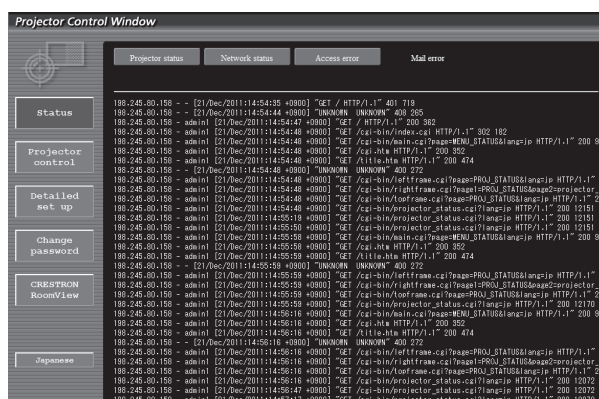

Note

- [Access error]/[Mail error] will display the recent few hundred accesses/requests. May be unable to display all information when many accesses/requests are made at one time.
- When [Access error]/[Mail error] exceeds a certain amount, old information will be erased.
- Check [Access error]/[Mail error] periodically.

[Basic control] page

Click [Projector control] → [Basic control].

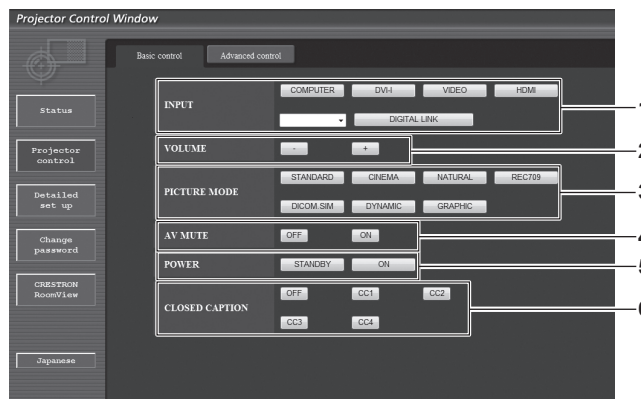

- 1 **[INPUT]**
Switches the input signal.
- 2 **[VOLUME]**
Adjusts the volume.
- 3 **[PICTURE MODE]**
Switches the video mode.
- 4 **[AV MUTE]**
Switches between AV mute On/Off.
- 5 **[POWER]**
Switches on/off the power.
- 6 **[CLOSED CAPTION]**
Switches the closed caption setting.

[Advanced control] page

Click [Projector control] → [Advanced control].

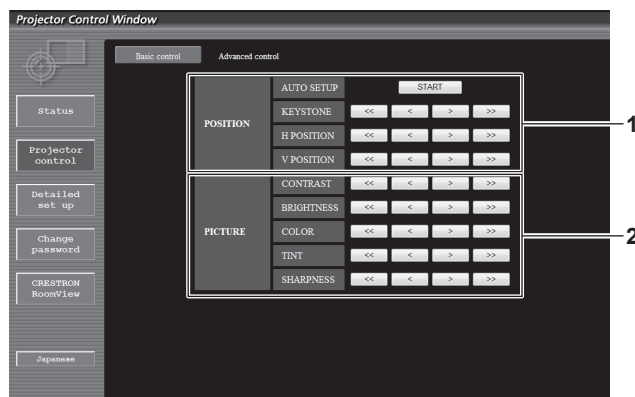

1 [POSITION]

Operates items related to angle of view.

2 [PICTURE]

Operates items related to image quality.

[Network config] page

Click [Detailed set up] → [Network config].

- Click [Network config] to display the **[CAUTION!]** screen.
- Click the [Next] button to display the current settings.
- The following setting change screen is displayed by clicking the [Change] button.

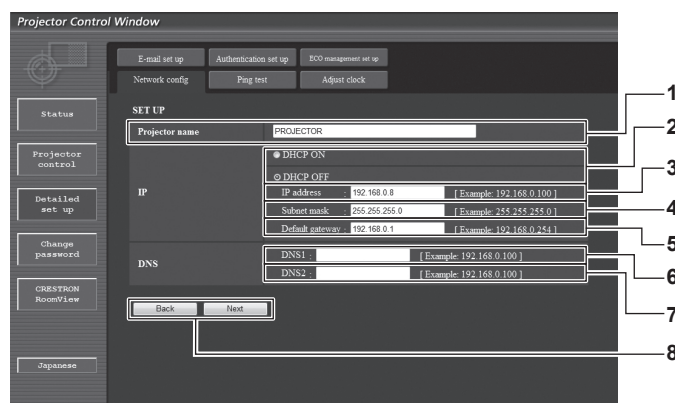

1 [Projector name]

Enter the name of the projector. Enter the host name if it is required when using a DHCP server etc.

2 [DHCP ON]/[DHCP OFF]

To enable the DHCP client function, set to [DHCP ON].

3 [IP address]

Enter the IP address when not using a DHCP server.

4 [Subnet mask]

Enter the subnet mask when not using a DHCP server.

5 [Default gateway]

Enter the default gateway address when not using a DHCP server.

6 [DNS1]

Enter the DNS1 server address.

Permissible characters for the entry of DNS1 server address (primary):
Numbers (0 to 9), period (.)
(Example: 192.168.0.253)

7 [DNS2]

Enter the DNS2 server address.

Permissible characters for the entry of DNS2 server address (secondary):
Numbers (0 to 9), period (.)
(Example: 192.168.0.254)

8 [Back]/[Next]

Click the [Back] button to return to the original screen. The current settings are displayed by pressing the [Next] button. Click the [Submit] button to update the settings.

Note

- When you use the “Forward” and “Back” functions of your browser, a warning message “Page has Expired” may appear. In that case, click [Network config] again since the following operation will not be guaranteed.
- Changing LAN settings while connected to the LAN may cause the connection to cut out.

[Ping test] page

You can check whether the network is connected to the E-mail server, POP server, DNS server, etc.
Click [Detailed set up] → [Ping test].

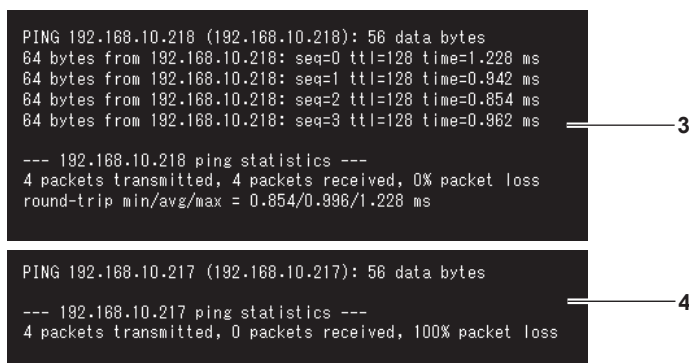
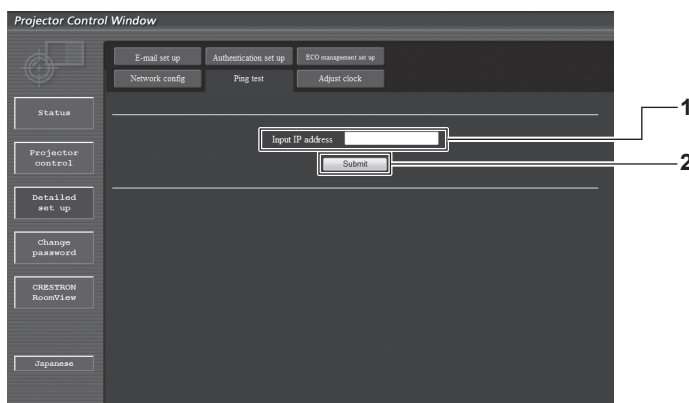

- | | |
|--|--|
| <p>1 [Input IP address]
Enter the IP address of the server to be tested.</p> <p>2 [Submit]
Executes the connection test.</p> | <p>3 Example of display when the connection has succeeded</p> <p>4 Example of display when the connection has failed</p> |
|--|--|

[Adjust clock] page

Click [Detailed set up] → [Adjust clock].

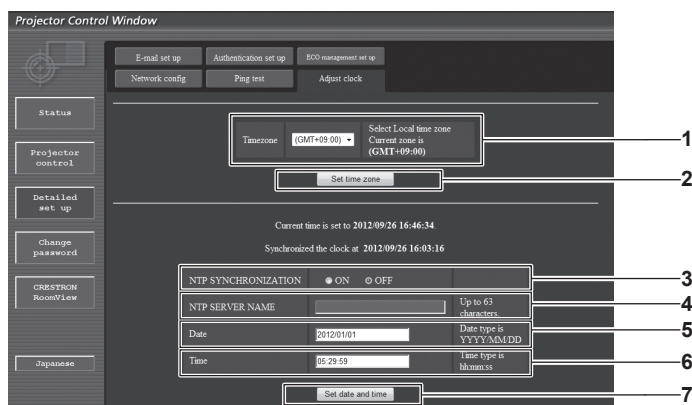

- | | |
|--|---|
| <p>1 [Timezone]
Select the time zone.</p> <p>2 [Set time zone]
Updates the time zone setting.</p> <p>3 [NTP SYNCHRONIZATION]
Set to [ON] to adjust the date and time automatically.</p> <p>4 [NTP SERVER NAME]
Enter the IP address or server name of the NTP server when you set to adjust the date and time manually.
(To enter the server name, the DNS server needs to be set up.)</p> | <p>5 [Date]
Enter the date to be changed.</p> <p>6 [Time]
Enter the time to be changed.</p> <p>7 [Set date and time]
Updates the date and time settings.</p> |
|--|---|

Note

- The replacement of the battery inside the projector is required when the time goes out of alignment right after correcting the time. Please consult your dealer.

[E-mail set up] page

When there is a problem, an email can be sent to preset email addresses (up to two addresses).
Click [Detailed set up] → [E-mail set up].

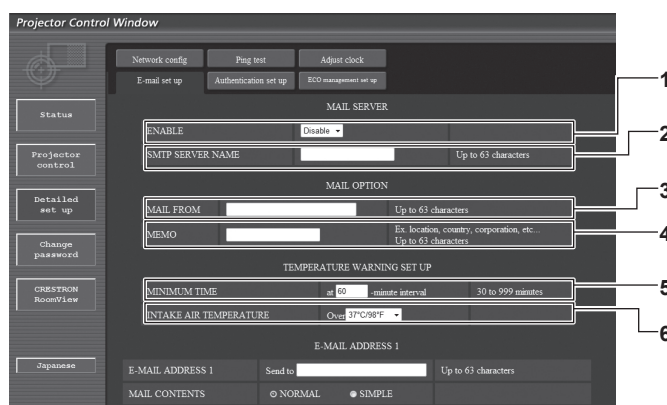

- 1 **[ENABLE]**
Select [Enable] to use the E-mail function.
- 2 **[SMTP SERVER NAME]**
Enter the IP address or the server name of the E-mail server (SMTP). To enter the server name, the setup of the DNS server is required.
- 3 **[MAIL FROM]**
Enter the E-mail address of the projector. (Up to 63 characters in single byte)
- 4 **[MEMO]**
Enter information such as the location of the projector that notifies the sender of the E-mail. (Up to 63 characters in single byte)
- 5 **[MINIMUM TIME]**
Change the minimum interval for the temperature warning mail. The default value is 60 minutes. In this case, another E-mail will not be sent for 60 minutes after sending the temperature warning mail even if it reaches the warning temperature.
- 6 **[INTAKE AIR TEMPERATURE]**
Change the temperature setting for the temperature warning mail. A temperature warning mail is sent when the temperature exceeds this value.

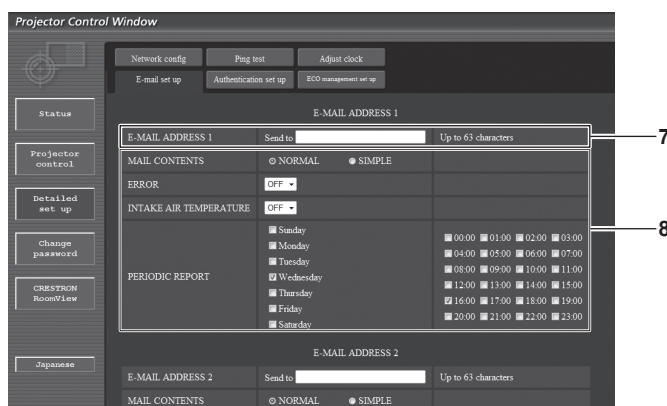

- 7 **[E-MAIL ADDRESS 1]**
Enter the E-mail address to be sent.
- 8 **Settings of the conditions to send E-mail**
Select the conditions to send E-mail.
[MAIL CONTENTS]:
Select either [NORMAL] or [SIMPLE].
[ERROR]:
An E-mail message is sent when an error occurred in the self-diagnosis.
[INTAKE AIR TEMPERATURE]:
An E-mail message is sent when the air intake temperature has reached the value set at the above field.
[PERIODIC REPORT]:
Place a check mark on this when E-mail is to be sent periodically.
It will be sent on the days and time with the check mark.

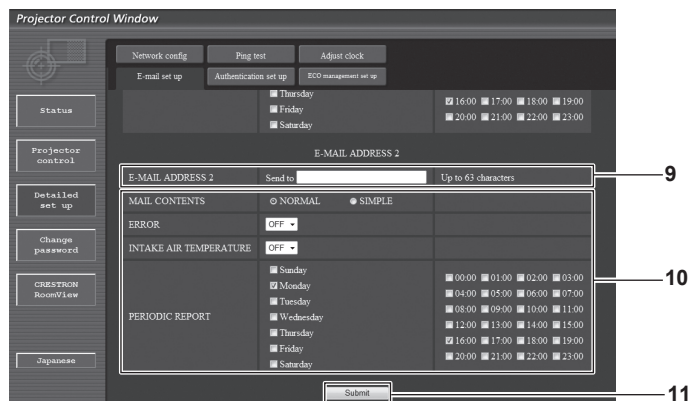

9 [E-MAIL ADDRESS 2]

Enter the E-mail address to be sent when two E-mail addresses are to be used.
Leave it blank when two E-mail addresses are not to be used.

10 Settings of the conditions to send E-mail

Select the conditions to send E-mail to the second E-mail address.

[MAIL CONTENTS]:

Select either [NORMAL] or [SIMPLE].

[ERROR]:

An E-mail message is sent when an error occurred in the self-diagnosis.

[INTAKE AIR TEMPERATURE]:

An E-mail message is sent when the air intake temperature has reached the value set at the above field.

[PERIODIC REPORT]:

Place a check mark on this to send E-mail to the second E-mail address periodically. It will be sent on the days and time with the check mark.

11 [Submit]

Update the settings.

[Authentication set up] page

You can set the authentication items when POP authentication or SMTP authentication is necessary to send an E-mail message.

Click [Detailed set up] → [Authentication set up].

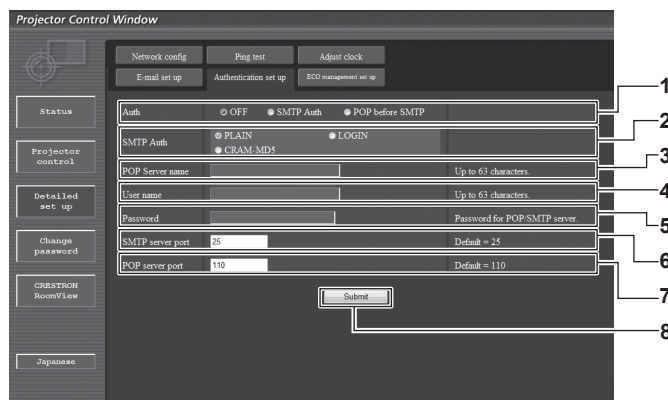

1 [Auth]

Select the authentication method specified by your Internet service provider.

2 [SMTP Auth]

Set when the SMTP authentication is selected.

3 [POP server name]

Enter the POP server name.

Allowed characters:

Alphanumerics (A to Z, a to z, 0 to 9)

Minus sign (-) and period (.)

4 [User name]

Enter the user name for the POP server or the SMTP server.

5 [Password]

Enter the password for the POP server or the SMTP server.

6 [SMTP server port]

Enter the port number of the SMTP server.

(Normally 25)

7 [POP server port]

Enter the port number of the POP server.

(Normally 110)

8 [Submit]

Update the settings.

Contents of mail sent

Example of E-mail sent when E-mail is set

The following E-mail is sent when the E-mail settings have been established.

```

=== Panasonic projector report(CONFIGURE) ===
Projector Type      : RW330
Serial No          : SW1234567

---- E-mail setup data ----
TEMPERATURE WARNING SETUP
MINIMUM TIME      at [ 60] minutes interval
INTAKE AIR TEMPERATURE Over[ 46 degC / 114 degF]

ERROR
INTAKE AIR TEMPERATURE [ ON ]
                       [ OFF ]

PERIODIC REPORT
Sunday [ ON ] Monday [ ON ] Tuesday [ ON ] Wednesday [ ON ]
Thursday [ ON ] Friday [ ON ] Saturday [ ON ]
00:00 [ ON ] 01:00 [ ON ] 02:00 [ ON ] 03:00 [ ON ]
04:00 [ ON ] 05:00 [ ON ] 06:00 [ ON ] 07:00 [ ON ]
08:00 [ ON ] 09:00 [ ON ] 10:00 [ ON ] 11:00 [ ON ]
12:00 [ ON ] 13:00 [ ON ] 14:00 [ ON ] 15:00 [ ON ]
16:00 [ ON ] 17:00 [ ON ] 18:00 [ ON ] 19:00 [ ON ]
20:00 [ ON ] 21:00 [ ON ] 22:00 [ ON ] 23:00 [ ON ]

---- check system ----
MAIN CPU BUS [ OK ]
FAN [ OK ]
INTAKE AIR TEMPERATURE [ OK ]
OPTICS MODULE TEMPERATURE [ OK ]
INTERNAL AIR TEMPERATURE [ OK ]
LIGHT STATUS [ OK ]
INTAKE AIR TEMP.SENSOR [ OK ]
OPTICS MODULE TEMP.SENSOR [ OK ]
INTERNAL AIR TEMP.SENSOR [ OK ]
BATTERY [ OK ]
PHOSPHOR WHEEL [ OK ]
(Error code 00 00 00 00 00 00 00 00 00 00 00 00 00 00 00)

Intake air temperature : [ 18 degC / 64 degF ]
Optics module temperature : [ 30 degC / 86 degF ]
Internal air temperature : [ 28 degC / 82 degF ]
PROJECTOR RUNTIME 9 H

----- Current status -----
MAIN VERSION 1.00
NETWORK VERSION 1.00
SUB VERSION 1.00
POWER STATUS POWER=STANDBY
INPUT SIGNAL DVI-D
SIGNAL NAME XGA60
SIGNAL FREQUENCY 48.36kHz / 60.00H

---- Wired Network configuration ----
DHCP Client OFF
IP address 192.168.0.8
MAC address 04:20:9A:00:00:00

Mon Jul 05 14:11:29 2012

---- Memo ----

```

Example of the E-mail sent for an error

The following E-mail is sent when an error has occurred.

```

=== Panasonic projector report(ERROR) ===
Projector Type   : RW330
Serial No       : SW1234567

----- check system -----
MAIN CPU BUS           [ OK ]
FAN                   [ OK ]
INTAKE AIR TEMPERATURE [ OK ]
OPTICS MODULE TEMPERATURE [ OK ]
INTERNAL AIR TEMPERATURE [ OK ]
LIGHT STATUS          [ OK ]
INTAKE AIR TEMP.SENSOR [ OK ]
OPTICS MODULE TEMP.SENSOR [ FAILED ]
INTERNAL AIR TEMP.SENSOR [ OK ]
BATTERY              [ OK ]
PHOSPHOR WHEEL       [ OK ]
(Error code 00 00 00 00 00 00 00 00 00 00 02 00 00 00 00)

Intake air temperature      : [ 18 degC / 64 degF ]
Optics module temperature   : [ 30 degC / 86 degF ]
Internal air temperature    : [ 28 degC / 82 degF ]
PROJECTOR RUNTIME          9 H

----- Current status -----
MAIN VERSION      1.00
NETWORK VERSION   1.00
SUB VERSION       1.00
POWER STATUS      POWER=STANDBY
INPUT SIGNAL      DVI-D
SIGNAL NAME       XGA60
SIGNAL FREQUENCY  48.36kHz / 60.00H

----- Wired Network configuration -----
DHCP Client       OFF
IP address        192.168.0.8
MAC address       04:20:9A:00:00:00

Mon Jul 05 14:11:29 2012

----- Memo -----
    
```

[ECO management set up] page

You can make settings for the ECO management function of the projector.
Click [Detailed set up] → [ECO management set up].

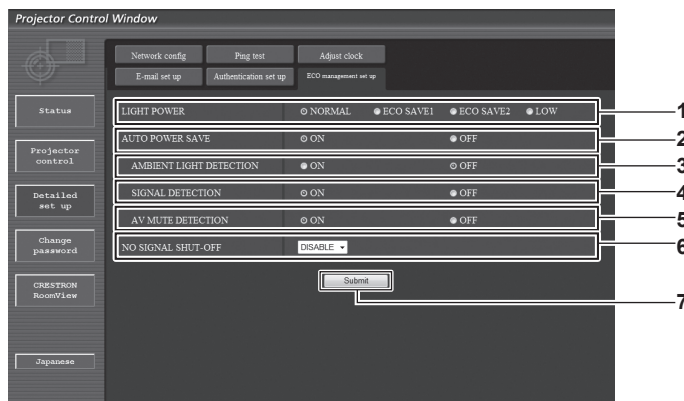

- | | |
|---|---|
| <p>1 [LIGHT POWER]
Select the light source power setting.</p> <p>2 [AUTO POWER SAVE]
Select [ON] to set [AMBIENT LIGHT DETECTION], [SIGNAL DETECTION], and [AV MUTE DETECTION].</p> <p>3 [AMBIENT LIGHT DETECTION]
Enable ([ON])/disable ([OFF]) the ambient light detection function.</p> | <p>4 [SIGNAL DETECTION]
Enable ([ON])/disable ([OFF]) the signal detection function.</p> <p>5 [AV MUTE DETECTION]
Enable ([ON])/disable ([OFF]) the AV mute detection function.</p> <p>6 [NO SIGNAL SHUT-OFF]
Select the time until the projector enters the standby mode when the signal detection function is used.</p> <p>7 [Submit]
Update the setting.</p> |
|---|---|

Note

- For detailed description of each setting item, refer to the [PROJECTOR SETUP] menu of the projector → [ECO MANAGEMENT] (➡ page 71).

User name [Change password] page

Click [Change password].

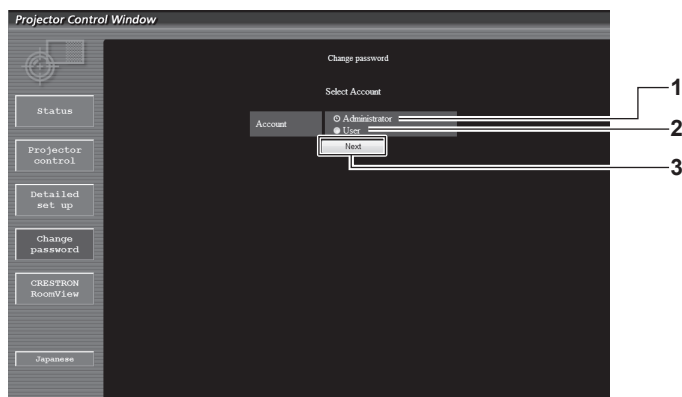

- 1 **[Administrator]**
Used to change the setting of [Administrator].
- 2 **[User]**
Used to change the setting of [User].
- 3 **[Next]**
Used to change the setting of the password.

[Administrator] account

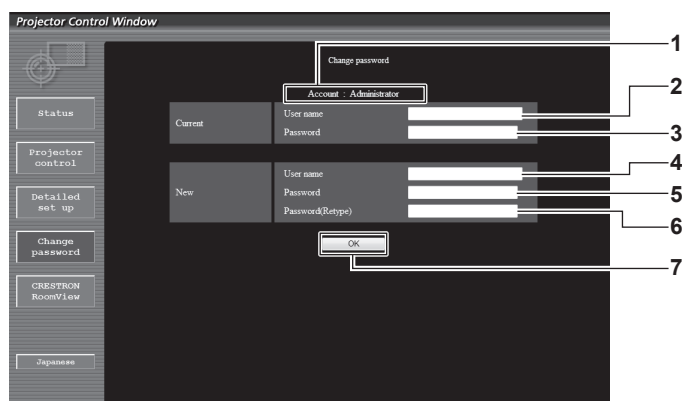

- 1 **[Account]**
Displays the account to change.
- 2 **[Current][User name]**
Enter the user name before the change.
- 3 **[Current][Password]**
Enter the current password.
- 4 **[New][User name]**
Enter the desired new user name. (Up to 16 characters in single byte)
- 5 **[New][Password]**
Enter the desired new password. (Up to 16 characters in single byte)
- 6 **[New][Password(Retype)]**
Enter the desired new password again.
- 7 **[OK]**
Determines the change of password.

[User] account

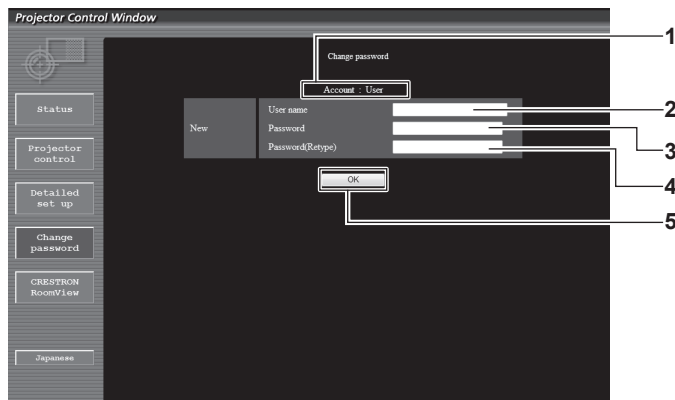

- | | |
|--|--|
| <p>1 [Account]
Displays the account to change.</p> <p>2 [New][User name]
Enter the desired new user name. (Up to 16 characters in single byte)</p> | <p>3 [New][Password]
Enter the desired new password. (Up to 16 characters in single byte)</p> <p>4 [New][Password(Retype)]
Enter the desired new password again.</p> <p>5 [OK]
Determines the change of password.</p> |
|--|--|

[Change password] (for user rights)

Only the change of password is enabled under the user rights.

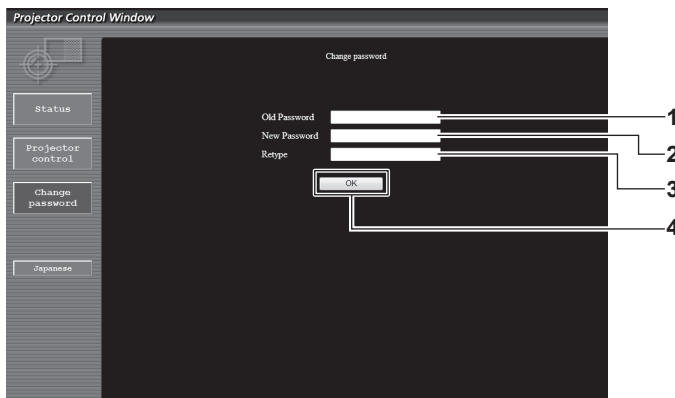

- | | |
|--|--|
| <p>1 [Old Password]
Enter the current password.</p> <p>2 [New Password]
Enter the desired new password. (Up to 16 characters in single byte)</p> | <p>3 [Retype]
Enter the desired new password again.</p> <p>4 [OK]
Determines the change of password.</p> |
|--|--|

Note

- To change the account of the administrator, you must enter the [Current] [User name] and [Password].

[CRESTRON RoomView] page

The projector can be monitored and/or controlled with RoomView.

To start the RoomView control page from the web control screen, you need to access with the administrator rights. (For user rights, the [CRESTRON RoomView] button is not displayed on the web control screen.)

The control page of RoomView is displayed by clicking [CRESTRON RoomView].

It is not displayed if Adobe Flash Player is not installed on the computer used, or the browser used does not support Flash. In that case, click [Back] on the control page to go back to the previous page.

Control page



- | | |
|--|---|
| <p>1 [Tools][Info][Help]
Tabs for selecting the setting, information, or help page of the projector.</p> <p>2 [POWER]
Switches the power on/off.</p> <p>3 [VOL DOWN]/[AV MUTE]/[VOL UP]
Operate the volume/AV mute.
These operations are not available when the power of the projector is turned off.</p> | <p>4 [Input Select]
Controls input selection.
Not available when the power of the projector is turned off.</p> <p>5 Menu screen control buttons
Navigates the menu screen.</p> <p>6 Freeze/image quality adjustment
Controls items related to freeze/image quality.</p> <p>7 [Back]
Performs return to the previous page.</p> |
|--|---|

[Tools] page

Click [Tools] on the control page.

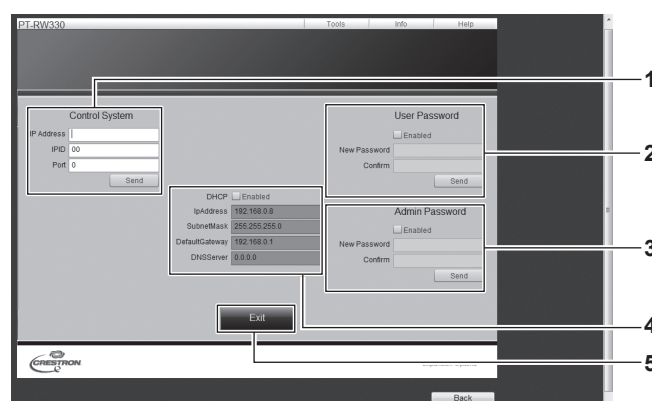

- | | |
|---|---|
| <p>1 [Control System]
Set the information required for communicating with the controller to be connected with the projector.</p> <p>2 [User Password]
Set the user rights password for the RoomView control page.</p> <p>3 [Admin Password]
Set the administrator rights password for the RoomView control page.</p> <p>4 Network Status
Displays the settings of wired LAN.
[DHCP]
Displays the current setting.
[IpAddress]
Displays the current setting.
[SubnetMask]
Displays the current setting.</p> | <p>[DefaultGateway]
Displays the current setting.
[DNSServer]
Displays the current setting.</p> <p>5 [Exit]
Returns to the control page.</p> |
|---|---|

[Info] page

Click [Info] on the control page.

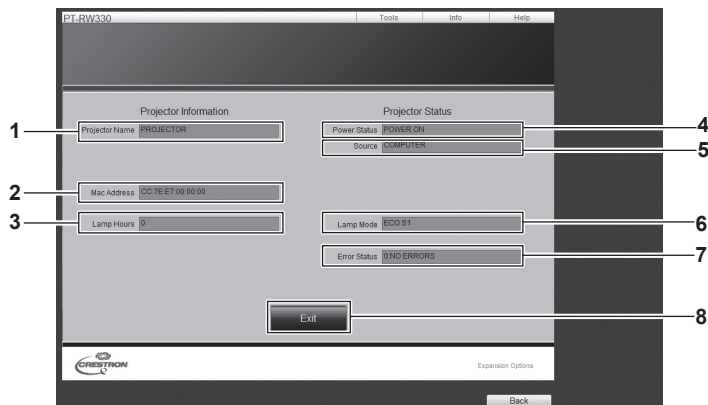

- | | |
|--|---|
| <p>1 [Projector Name]
Displays the projector name.</p> <p>2 [Mac Address]
Displays the MAC address.</p> <p>3 [Lamp Hours]
Displays the cumulative operating time (converted value) of the projector.</p> <p>4 [Power Status]
Displays the status of the power.</p> | <p>5 [Source]
Displays the selected image input.</p> <p>6 [Lamp Mode]
Displays the light source mode.</p> <p>7 [Error Status]
Displays the error status.</p> <p>8 [Exit]
Returns to the control page.</p> |
|--|---|

[Help] page

Click [Help] on the control page.

The [Help Desk] window is displayed.



- 1 [Help Desk]**
Messages can be sent to or received from an administrator who uses Crestron RoomView.

[DIGITAL LINK] menu

On the menu screen, select [DIGITAL LINK] from the main menu.
Refer to “Navigating through the menu” (➔ page 42) for the operation of the menu screen.

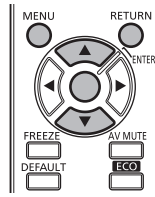

Switch the input to DIGITAL LINK.

Note

- When the optional digital interface box (Model No.: ET-YFB100G) is connected to the <DIGITAL LINK/LAN> terminal, the main menu of ET-YFB100G is displayed. Refer to the user manual supplied with ET-YFB100G for details.
- When a twisted-pair-cable transmitter of other company is connected to the projector, the main menu of the projector is displayed.

Chapter 5 Maintenance

This chapter describes inspection when there are problems, and maintenance methods.

Light source/temperature indicator

Managing the indicated problems

If a problem should occur inside the projector, the light source indicator <LIGHT>/temperature indicator <TEMP> will inform you by lighting or flashing.

Check the status of the indicators and manage the indicated problems as follows.

Attention

- When switching off the projector to deal with problems, make sure to follow the procedure in “Switching off the projector” (➔ page 35).
- Check the status of the power supply with the power indicator <ON (G)/STANDBY (R)>. (➔ page 33)

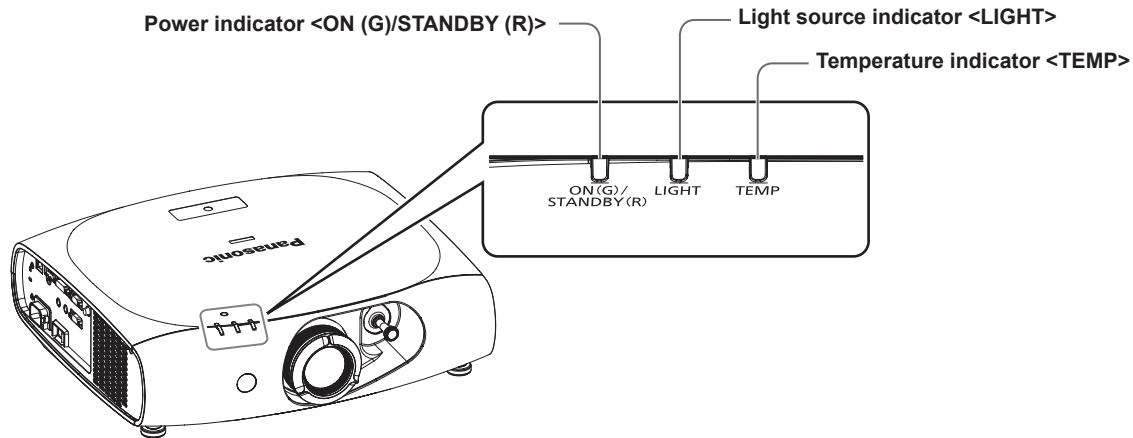

Light source indicator <LIGHT>

Indicator status	Lighting in red (Projection status)	Flashing in red (2 time)	Flashing in red (3 time)
Status	The light source may not light normally.	The light source does not turn on or turns off unexpectedly.	
Cause	—		
Solution	Set the <MAIN POWER> switch to <OFF> (➔ page 35), and turn on the power again.		

Note

- If the light source indicator <LIGHT> still lights or flashing after taking the preceding measures, set the <MAIN POWER> switch to <OFF> (➔ page 35), and ask your dealer to repair the unit.

Temperature indicator <TEMP>

Indicator status	Lighting in red		Flashing in red (1 time)	Flashing in red (2 time)	Flashing in red (3 time)
Status	Warm-up status	Internal temperature is high (warning).	Internal temperature is high (during projection).	Internal temperature is high (standby warning).	The fan has stopped.
Cause	<ul style="list-style-type: none"> Did you turn on the power when the room temperature was low (about 0 °C (32 °F))? 	<ul style="list-style-type: none"> Is the air intake/exhaust port blocked? Is the room temperature high? Is [HIGH ALTITUDE MODE] set correctly? 			—
Solution	<ul style="list-style-type: none"> Wait at least five minutes in the current status. Install the projector in a location with an ambient temperature of 0 °C (32 °F) to 45 °C (113 °F)^{*1}. 	<ul style="list-style-type: none"> Remove any objects that are blocking the air intake/exhaust port. Set up the projector in a location with an ambient temperature of 0 °C (32 °F) to 45 °C (113 °F)^{*1}. When using the projector at high altitudes between 1 400 m (4 593') and 2 700 m (8 858') above sea level, set [HIGH ALTITUDE MODE] (➔ page 71) to [ON]. Do not use the projector at high elevations 2 700 m (8 858') or higher above sea level. 			<ul style="list-style-type: none"> Set the <MAIN POWER> switch to <OFF> (➔ page 35), and consult your dealer.

*1 When using the projector at high altitudes (1 400 m (4 593') – 2 700 m (8 858') above sea level), the ambient temperature will be 0 °C (32 °F) – 40 °C (104 °F).

Note

- If the temperature indicator <TEMP> is still lit or flashing after taking the preceding measures, ask your dealer to repair the projector.

Maintenance

Before maintaining the projector

- Make sure to turn off the power before maintaining the projector. (➔ pages 33, 35)
- When switching off the projector, make sure to follow the procedures in “Switching off the projector” (➔ page 35).

Maintenance

Outer case

Wipe off dirt and dust with a soft, dry cloth.

- If the dirt is persistent, soak the cloth with water and wring it thoroughly before wiping. Dry off the projector with a dry cloth.
- Do not use benzene, thinner, or rubbing alcohol, other solvents, or household cleaners. Doing so may deteriorate the outer case.
- When using chemically treated dust cloths, follow the instructions written on its packaging.

Lens front surface

Wipe off dirt and dust from the front surface of the lens with a soft clean cloth.

- Do not use a cloth that is fluffy, dusty, or soaked with oil/water.
- Since the lens is fragile, do not use excessive force when wiping the lens.

Attention

- The lens is made of glass. Impacts or excessive force when wiping may scratch its surface. Please handle with care.

Cleaning inside the projector

Ask your dealer about cleaning inside the projector every 20 000 hours of usage as an estimated duration.

- If the projector is used in a dusty place, cleaning may be required before the usage time has reached 20 000 hours.
- If the light source goes off or the brightness reduces noticeably, ask your dealer about replacement of the light source unit.

Troubleshooting

Review the following points. For details, refer to the corresponding pages.

Problems	Points to be checked	Page
Power does not turn on.	• Is the power plug firmly inserted into the outlet?	—
	• Is the <MAIN POWER> switch turned <OFF>?	35
	• Is the wall outlet supplying electricity?	—
	• Have the circuit breakers tripped?	—
	• Is the temperature indicator <TEMP> or the light source indicator <LIGHT> lit or flashing?	110
No image appears.	• Are connections to external devices correctly performed?	28
	• Is the input selection setting correct?	39, 75
	• Is the [BRIGHTNESS] adjustment setting at a minimum?	48
	• Is the external device that is connected to the projector working properly?	—
	• Is the AV mute function in use?	38
The image is fuzzy.	• Is the lens focus set correctly?	36
	• Is the projection distance appropriate?	26
	• Is the lens dirty?	16
	• Is the projector installed perpendicular to the screen?	—
The color is pale or grayish.	• Is the [COLOR] or [TINT] adjusted correctly?	48
	• Is the external device connected to the projector adjusted correctly?	28
	• Is the RGB cable damaged?	—
The remote control does not respond.	• Are the batteries depleted?	—
	• Is the polarity of the batteries set correctly?	23
	• Are there any obstructions between the remote control and the remote control signal receiver of the projector?	20
	• Is the remote control being used beyond its effective operation range?	20
	• Are other forms of light, such as fluorescent light, affecting the projection?	20
	• Is the [REMOTE CONTROL] setting in [CONTROL DEVICE SETUP] set to [DISABLE]?	88
	• Is the ID number setting operation correct?	23
The buttons on the control panel do not operate.	• Is the [CONTROL PANEL] setting in [CONTROL DEVICE SETUP] set to [DISABLE]?	88
The image does not display correctly.	• Is the [SYSTEM SELECTOR] selection set correctly?	51
	• Is there a problem with the video tape or other image sources?	—
	• Is a signal which is not compatible with the projector being input?	122
Image from a computer does not appear.	• Is the cable too long? (Use D-Sub cables that are 10 m (32'10") or shorter.)	—
	• Is the external video output of the laptop computer set correctly? (Ex.: The external output settings may be switched by pressing the "Fn" + "F3" or "Fn" + "F10" keys simultaneously. Since the method varies depending on the computer type, refer to the user manual provided with your computer.)	—
Image from a computer's DVI-I output does not appear.	• Is the [DVI-I IN] setting set to [EDID3]/[EDID2]?	63
	• The graphics accelerator driver of the computer may need to be updated to the latest version.	—
	• The computer may need to be restarted after performing [DVI-I IN] settings.	63
	• Is the [DIGITAL/ANALOG] setting in [DVI-I IN] correct?	63
Video from HDMI compatible device does not appear or it appears jumbled.	• Is the HDMI cable connected securely?	28
	• Turn the power of the projector and the external device on and off.	—
	• Is a signal which is not compatible with the projector being input?	122
No audio is coming from the HDMI compatible device	• Set audio of the external device to linear PCM.	—
	• Check [AUDIO IN SELECT] in [AUDIO SETTING].	79
	• When there is no audio through the HDMI cable connection, use the <AUDIO IN> terminal.	79

Chapter 5 Maintenance — Troubleshooting

Problems	Points to be checked	Page
There is no DIGITAL LINK input audio or video.	<ul style="list-style-type: none">• Are the connections between the twisted-pair-cable transmitter and the projector or an external device correctly done?• Is [DIGITAL LINK MODE] set to [AUTO] or [DIGITAL LINK]? Is it set to [ETHERNET]?	— 89

Attention

- If problems persist even after checking the preceding points, consult your dealer.

Chapter 6 **Appendix**

This chapter describes specifications and after-sales service for the projector.

Technical information

PJLink protocol

The network function of this projector supports the PJLink class 1, and the PJLink protocol can be used to perform projector setting and projector status query operations from a computer.

Control commands

The following table lists the PJLink protocol commands that can be used to control the projector.

- The "x" in the table are arbitrary characters.

Command	Control details	Parameter/response character string	Remark													
POWR	Power supply control	0 1	Standby Power on													
POWR?	Power supply status query	0 1 2 3	Standby Power on Preparing for switching off the projector Warm-up													
INPT	Input selection	11 12 21	COMPUTER DVI-I (When [DVI-I IN] is set to [ANALOG]) VIDEO													
INPT?	Input selection query	31 32 33	DVI-I (When [DVI-I IN] is set to [DIGITAL]) HDMI DIGITAL LINK													
AVMT	AV mute control	30	AV mute function off													
AVMT?	AV mute function query	31	AV mute function on													
ERST?	Error status query	xxxxxx	<table border="1"> <tr> <td>1st byte</td> <td>Indicates fan errors, and returns 0 - 2.</td> <td rowspan="6"> <ul style="list-style-type: none"> • 0 = No error is detected • 1 = Warning • 2 = Error </td> </tr> <tr> <td>2nd byte</td> <td>Indicates light source errors, and returns 0 - 2.</td> </tr> <tr> <td>3rd byte</td> <td>Indicates temperature errors, and returns 0 - 2.</td> </tr> <tr> <td>4th byte</td> <td>Indicates cover open errors, and returns 0 or 2.</td> </tr> <tr> <td>5th byte</td> <td>Returns 0.</td> </tr> <tr> <td>6th byte</td> <td>Indicates other errors, and returns 0 - 2.</td> </tr> </table>	1st byte	Indicates fan errors, and returns 0 - 2.	<ul style="list-style-type: none"> • 0 = No error is detected • 1 = Warning • 2 = Error 	2nd byte	Indicates light source errors, and returns 0 - 2.	3rd byte	Indicates temperature errors, and returns 0 - 2.	4th byte	Indicates cover open errors, and returns 0 or 2.	5th byte	Returns 0.	6th byte	Indicates other errors, and returns 0 - 2.
1st byte	Indicates fan errors, and returns 0 - 2.	<ul style="list-style-type: none"> • 0 = No error is detected • 1 = Warning • 2 = Error 														
2nd byte	Indicates light source errors, and returns 0 - 2.															
3rd byte	Indicates temperature errors, and returns 0 - 2.															
4th byte	Indicates cover open errors, and returns 0 or 2.															
5th byte	Returns 0.															
6th byte	Indicates other errors, and returns 0 - 2.															
LAMP?	Light source status query	ERR1	Undefined command													
INST?	Input selection list query	11 12 21 32 33 11 21 31 32 33	When [DVI-I IN] is set to [ANALOG] When [DVI-I IN] is set to [DIGITAL]													
NAME?	Projector name query	xxxxx	Returns the name set in [PROJECTOR NAME] of [NETWORK SETUP].													
INF1?	Manufacturer name query	Panasonic	Returns manufacturer name.													
INF2?	Model name query	RZ370 RW330	Returns model name.													
INF0?	Other information queries	xxxxx	Returns information such as version number.													
CLSS?	Class information query	1	Returns class for PJLink.													

PJLink security authentication

The password used for PJLink is the same as that of the password set for web control.

When using the projector without security authentication, do not set a password for web control.

- For specifications regarding PJLink, refer to the Japan Business Machine and Information System Industries Association website.
URL <http://pjlink.jbmia.or.jp/english/>

Control commands via LAN

When web control administrator rights password is set (Protect mode)

Connecting

1) Obtain the IP address and port number (Initial set value = 1024) of the projector and request for a connection to the projector.

- You can obtain both the IP address and the port number from the menu screen of the projector.

IP address	Obtain from the main menu → [NETWORK] → [NETWORK STATUS]
Port number	Obtain from the main menu → [NETWORK] → [NETWORK CONTROL] → [COMMAND PORT]

2) Check the response from the projector

	Data section	Blank	Mode	Blank	Random number section	Termination symbol
Command example	"NTCONTROL" (ASCII string)	' ' 0x20	'1' 0x31	' ' 0x20	"ZZZZZZZ" (ASCII code hexadecimal number)	(CR) 0x0d
Data length	9 bytes	1 byte	1 byte	1 byte	8 bytes	1 byte

- Mode: 1 = Protect mode

3) Generate a 32-byte hash value from the following data using MD5 algorithm.

- "xxxxxx:yyyy:zzzzzzz"

xxxxxx	Administrator rights user name for Web control (default user name is "admin1")
yyyyy	Password of above administrator rights user (default password is "panasonic")
zzzzzzz	8-byte random number obtained in Step 2)

Command transmission method

Transmit using the following command formats.

■ Transmitted data

	Header			Data section	Termination symbol
Command example	Hash value (Refer to "Connecting" above)	'0' 0x30	'0' 0x30	Control command (ASCII string)	(CR) 0x0d
Data length	32 bytes	1 byte	1 byte	Undefined length	1 byte

■ Received data

	Header		Data section	Termination symbol
Command example	'0' 0x30	'0' 0x30	Control command (ASCII string)	(CR) 0x0d
Data length	1 byte	1 byte	Undefined length	1 byte

■ Error response

	Character string	Details	Termination symbol
Message	"ERR1"	Undefined control command	(CR) 0x0d
	"ERR2"	Out of parameter range	
	"ERR3"	Busy state or no-acceptable period	
	"ERR4"	Timeout or no-acceptable period	
	"ERR5"	Wrong data length	
	"ERRA"	Password mismatch	
Data length	4 bytes	—	1 byte

When web control administrator rights password is not set (Non-protect mode)

Connecting

1) Obtain the IP address and port number (Initial set value = 1024) of the projector and request for a connection to the projector.

- You can obtain both the IP address and the port number from the menu screen of the projector.

IP address	Obtain from the main menu → [NETWORK] → [NETWORK STATUS]
Port number	Obtain from the main menu → [NETWORK] → [NETWORK CONTROL] → [COMMAND PORT]

2) Check the response from the projector

	Data section	Blank	Mode	Termination symbol
Command example	"NTCONTROL" (ASCII string)	' '	'0'	(CR) 0x0d
Data length	9 bytes	1 byte	1 byte	1 byte

- Mode: 0 = Non-protect mode

Command transmission method

Transmit using the following command formats.

■ Transmitted data

	Header		Data section	Termination symbol
Command example	'0' 0x30	'0' 0x30	Control command (ASCII string)	(CR) 0x0d
Data length	1 byte	1 byte	Undefined length	1 byte

■ Received data

	Header		Data section	Termination symbol
Command example	'0' 0x30	'0' 0x30	Control command (ASCII string)	(CR) 0x0d
Data length	1 byte	1 byte	Undefined length	1 byte

■ Error response

	Character string	Details	Termination symbol
Message	"ERR1"	Undefined control command	(CR) 0x0d
	"ERR2"	Out of parameter range	
	"ERR3"	Busy state or no-acceptable period	
	"ERR4"	Timeout or no-acceptable period	
	"ERR5"	Wrong data length	
	"ERRA"	Password mismatch	
Data length	4 bytes	—	1 byte

<SERIAL IN> terminal

The <SERIAL IN> terminal of the projector conforms with RS-232C so that the projector can be connected to and controlled from a computer.

Connection

● To connect directly

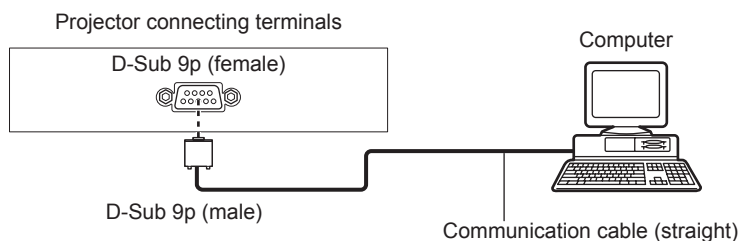

● To connect using DIGITAL LINK compatible device

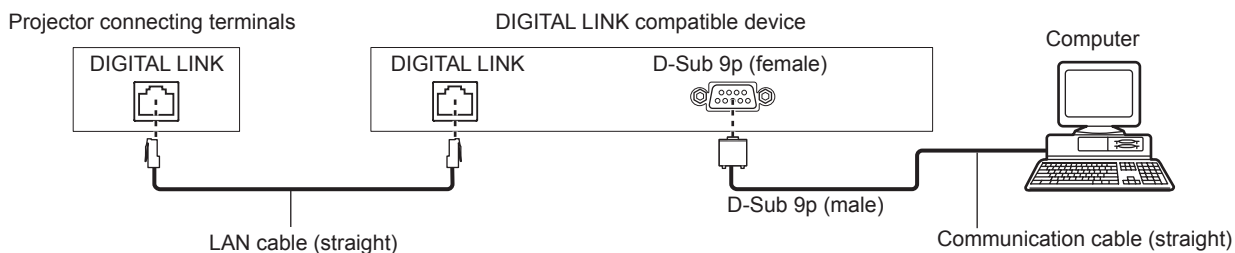

Note

- The [RS-232C] (➔ page 76) connection destination must be set based on connection method.

Pin assignments and signal names

D-Sub 9-pin (female) Outside view	Pin No.	Signal name	Details
	(1)	—	NC
	(2)	TXD	Transmitted data
	(3)	RXD	Received data
	(4)	—	NC
	(5)	GND	Earth
	(6)	—	Connected internally
	(7)	CTS	
	(8)	RTS	
	(9)	—	NC

Communication conditions (Factory default)

Signal level	RS-232C-compliant
Sync. method	Asynchronous
Baud rate	9 600 bps
Parity	None
Character length	8 bits
Stop bit	1 bit
X parameter	None
S parameter	None

Basic format

Transmission from the computer starts with STX, then the ID, command, parameter, and ETX are sent in this order. Add parameters according to the details of control.

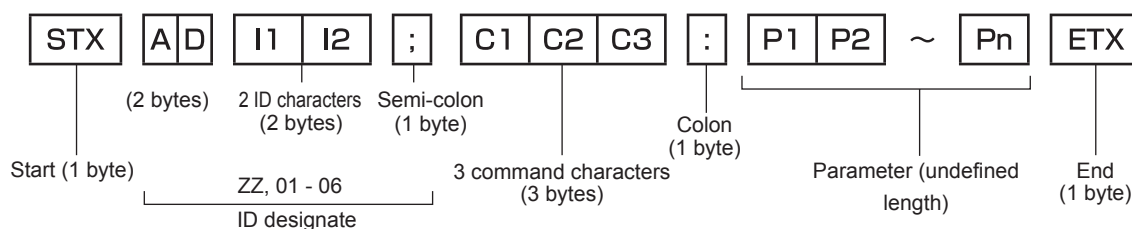

Basic format (has subcommands)

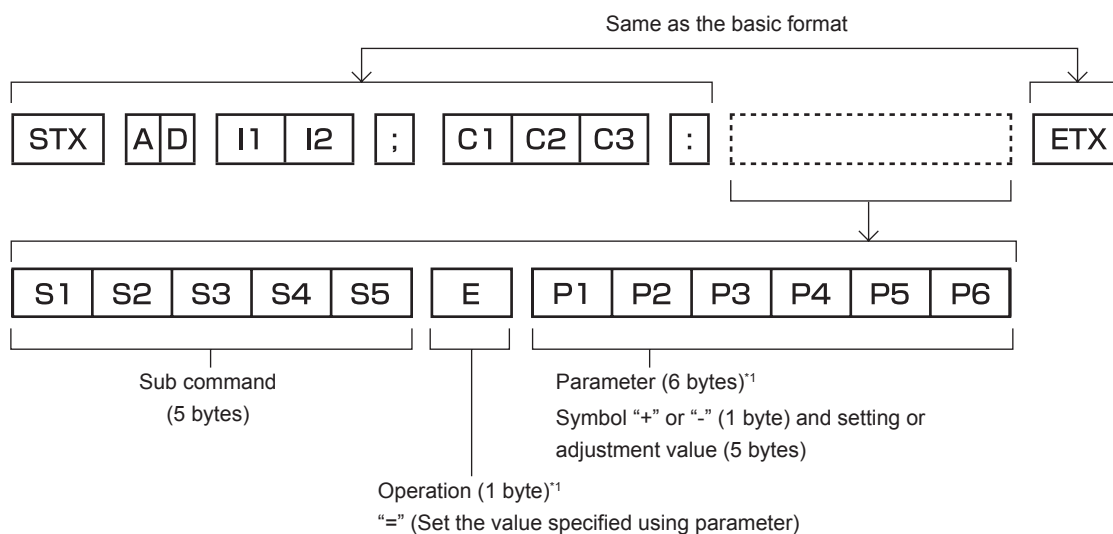

*1 When transmitting a command which does not need a parameter, an operator (E) and parameter are not necessary.

Attention

- If a command is transmitted after the light source starts illuminating, there may be a delay in response or the command may not be executed. Try sending or receiving any command after 60 seconds.
- When transmitting multiple commands, be sure to wait until 0.5 seconds has elapsed after receiving the response from the projector before sending the next command. When transmitting a command which does not need a parameter, a colon (:) is not necessary.

Note

- If a command cannot be executed, the "ER401" response is sent from the projector to the computer.
- If an invalid parameter is sent, the "ER402" response is sent from the projector to the computer.
- ID transmission in RS-232C supports ZZ (ALL) and 01 to 06.
- If a command is sent with a specified ID, a response will be sent to the computer only in the following cases.
 - It matches the projector ID
 - The projector's [PROJECTOR ID] (▶ page 70) is [ALL]
- STX and ETX are character codes. STX shown in hexadecimal is 02, and ETX shown in hexadecimal is 03.

Cable specification

When connected to a computer

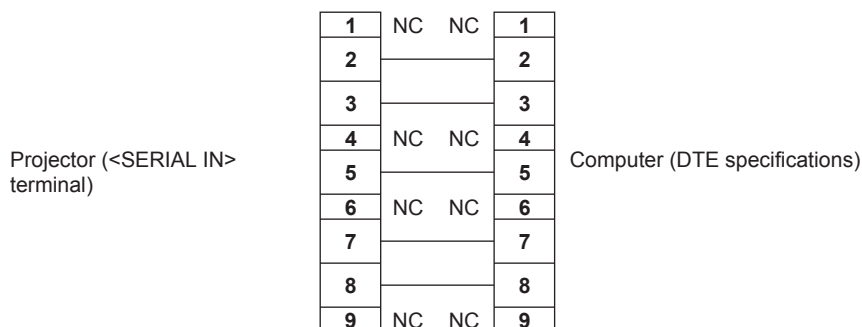

Control command

The following table lists the commands that can be used to control the projector using a computer.

■ Projector control command

Command	Details	Parameter/response character string	Remark (parameter)
PON	Power on	—	To check if the power is on, use the "Power query" command.
POF	Power standby		
QPW	Power query	000 001	Standby Power on
IIS	Switching the input signal	VID RG1 DVI HD1 DL1	VIDEO COMPUTER DVI-I HDMI DIGITAL LINK
OLP	Light source power settings	0 1	Normal Low
QLP	Light source power settings query	6 7	ECO SAVE 1 ECO SAVE 2
QST	Projector runtime query	00000 - 99999	In hours
OSH	AV mute	0	End
QSH	AV mute function query	1	Execute
VSE	Aspect ratio switch	0 1 2 5	Normal 4:3 Wide Real
QSE	Aspect ratio settings query	6 9 10	Full H FIT V FIT
OCS	Sub memory switch	01 - 96	Sub memory number
QSB	Sub memory status query		

Menu lock password

To initialize your password, consult your distributor.

List of compatible signals

The following table specifies the types of signals compatible with the projector.

- Signals that show formats are as follows.

- V: Video
- R: RGB
- Y: YC_BCR/YP_BPR
- D: DVI-I
- H: HDMI

Mode	Resolution (Dots)	Scanning frequency		Dot clock freq. (MHz)	Format	Plug and play ¹				
		Horizontal (kHz)	Vertical (Hz)			COMPUTER/ DVI-I Analog EDID	DVI-I digital			HDMI/ DIGITAL LINK
							EDID1	EDID2	EDID3	
NTSC/NTSC4.43/ PAL-M/PAL60	720 x 480i	15.7	59.9	—	V	—	—	—	—	—
PAL/PAL-N/SECAM	720 x 576i	15.6	50.0	—	V	—	—	—	—	—
525i (480i)	720 x 480i	15.7	59.9	13.5	R/Y	—	—	—	—	—
625i (576i)	720 x 576i	15.6	50.0	13.5	R/Y	—	—	—	—	—
525p (480p)	720 x 483	31.5	59.9	27.0	R/Y/D/H	—	✓	—	✓	✓
625p (576p)	720 x 576	31.3	50.0	27.0	R/Y/D/H	—	✓	—	✓	✓
750 (720)/60p	1 280 x 720	45.0	60.0	74.3	R/Y/D/H	—	✓	—	✓	✓
750 (720)/50p	1 280 x 720	37.5	50.0	74.3	R/Y/D/H	—	✓	—	✓	✓
1125 (1080)/60i ²	1 920 x 1 080i	33.8	60.0	74.3	R/Y/D/H	—	✓	—	✓	✓
1125 (1080)/50i	1 920 x 1 080i	28.1	50.0	74.3	R/Y/D/H	—	✓	—	✓	✓
1125 (1080)/24p	1 920 x 1 080	27.0	24.0	74.3	R/Y/D/H	—	✓	—	✓	✓
1125 (1080)/24sF	1 920 x 1 080i	27.0	24.0	74.3	R/Y/D/H	—	—	—	—	—
1125 (1080)/25p	1 920 x 1 080	28.1	25.0	74.3	R/Y/D/H	—	✓	—	✓	—
1125 (1080)/30p	1 920 x 1 080	33.8	30.0	74.3	R/Y/D/H	—	—	—	—	—
1125 (1080)/60p	1 920 x 1 080	67.5	60.0	148.5	R/Y/D/H	—	✓	—	✓	✓
1125 (1080)/50p	1 920 x 1 080	56.3	50.0	148.5	R/Y/D/H	—	✓	—	✓	✓
VESA400	640 x 400	37.9	85.1	31.5	R/D/H	—	—	—	—	—
VGA	640 x 400	31.5	70.1	25.2	R/D/H	—	—	—	—	—
	640 x 480	31.5	59.9	25.2	R/D/H	✓	✓	✓	✓	✓
	640 x 480	35.0	66.7	30.2	R/D/H	—	—	—	—	—
	640 x 480	37.9	72.8	31.5	R/D/H	✓	—	✓	✓	✓
	640 x 480	37.5	75.0	31.5	R/D/H	✓	—	✓	✓	✓
SVGA	640 x 480	43.3	85.0	36.0	R/D/H	—	—	—	—	—
	800 x 600	35.2	56.3	36.0	R/D/H	✓	—	✓	✓	✓
	800 x 600	37.9	60.3	40.0	R/D/H	✓	—	✓	✓	✓
	800 x 600	48.1	72.2	50.0	R/D/H	✓	—	✓	✓	✓
	800 x 600	46.9	75.0	49.5	R/D/H	✓	—	✓	✓	✓
MAC16	800 x 600	53.7	85.1	56.3	R/D/H	—	—	—	—	—
	832 x 624	49.7	74.6	57.3	R/D/H	✓	—	✓	✓	✓
	1 024 x 768	39.6	50.0	51.9	R/D/H	—	—	—	—	—
	1 024 x 768	48.4	60.0	65.0	R/D/H	✓	—	✓	✓	✓
	1 024 x 768	56.5	70.1	75.0	R/D/H	✓	—	✓	✓	✓
XGA	1 024 x 768	60.0	75.0	78.8	R/D/H	✓	—	✓	✓	✓
	1 024 x 768	65.5	81.6	86.0	R/D/H	—	—	—	—	—
	1 024 x 768	68.7	85.0	94.5	R/D/H	—	—	—	—	—
	1 024 x 768	80.0	100.0	105.0	R/D/H	—	—	—	—	—
	1 024 x 768	99.0	119.8	137.8	R/D/H	—	—	—	—	—
MXGA	1 152 x 864	64.0	70.0	94.2	R/D/H	—	—	—	—	—
	1 152 x 864	67.5	74.9	108.0	R/D/H	—	—	—	—	—
	1 152 x 864	77.1	85.0	119.7	R/D/H	—	—	—	—	—
MAC21	1 152 x 870	68.7	75.1	100.0	R/D/H	✓	—	✓	✓	✓
MSXGA	1 280 x 960	60.0	60.0	108.0	R/D/H	—	—	—	—	—

Mode	Resolution (Dots)	Scanning frequency		Dot clock freq. (MHz)	Format	Plug and play ^{*1}				
		Horizontal (kHz)	Vertical (Hz)			COMPUTER/ DVI-I Analog EDID	DVI-I digital			HDMI/ DIGITAL LINK
							EDID1	EDID2	EDID3	
SXGA	1 280 x 1 024	64.0	60.0	108.0	R/D/H	✓	—	✓	✓	✓
	1 280 x 1 024	80.0	75.0	135.0	R/D/H	✓	—	✓	✓	✓
	1 280 x 1 024	91.1	85.0	157.5	R/D/H	—	—	—	—	—
SXGA+	1 400 x 1 050	65.2	60.0	122.6	R/D/H	✓	—	✓	✓	✓
	1 400 x 1 050	65.3	60.0	121.8	R/D/H	—	—	—	—	—
	1 400 x 1 050	82.2	75.0	155.9	R/D/H	—	—	—	—	—
UXGA	1 600 x 1 200	75.0	60.0	162.0	R/D/H	✓	—	✓	✓	✓
1280 x 720	1 280 x 720	37.1	49.8	60.5	R/D/H	—	—	—	—	—
	1 280 x 720	44.8	59.9	74.5	R/D/H	—	—	—	—	—
1280 x 768	1 280 x 768	39.6	49.9	65.3	R/D/H	—	—	—	—	—
	1 280 x 768	47.8	59.9	79.5	R/D/H	—	—	—	—	—
1280 x 800	1 280 x 800	41.3	50.0	68.0	R/D/H	—	—	—	—	—
	1 280 x 800	49.7	59.8	83.5	R/D/H	—	—	—	—	—
WXGA+	1 440 x 900	55.9	59.9	106.5	R/D/H	—	—	—	—	—
WSXGA+	1 680 x 1 050	65.3	60.0	146.3	R/D/H	—	—	—	—	—
1920 x 1080	1 920 x 1 080 ^{*3}	66.6	59.9	138.5	R/D/H	—	—	—	—	—
WUXGA	1 920 x 1 200 ^{*3}	74.0	60.0	154.0	R/D/H	✓	—	✓	✓	✓

*1 Signals with ✓ in the Plug and play columns are signals described in EDID (extended display identification data) of the projector. A signal, which has no ✓ in the Plug and play columns but has an entry in the Format column, can be input. For signals without ✓ in the Plug and play columns, resolution may not be selected in the computer even though the projector supports them.

*2 When a 1125 (1035)/60i signal was input, it is displayed as a 1125 (1080)/60i signal.

*3 VESA CVT-RB (Reduced Blanking) compatible

Note

- The number of display dots for PT-RZ370EA is 1 920 x 1 080, and that for PT-RW330EA is 1 280 x 800. A signal with a different resolution is converted to the number of display dots and displayed.
- The “i” at the end of the resolution indicates an interlaced signal.
- When interlaced signals are connected, flickering may occur on the projected image.
- DIGITAL LINK input compatible signal is the same as HDMI input compatible signal.

Specifications

The following table describes the specifications of the projector.

Model No.		PT-RZ370EA	PT-RW330EA
Power supply		AC 100 V - 240 V 50 Hz/60 Hz	
Power consumption		460 W (5.2 A - 2.0 A)	
		0.5 W when [STANDBY MODE] is set to [ECO] 8 W when [STANDBY MODE] is set to [NORMAL] (when fan is stopped)	
DLP chips	Panel size	16.5 mm (0.65") (aspect ratio 16:9)	16.5 mm (0.65") (aspect ratio 16:10)
	Display method	1-unit DLP chips, DLP type	
	Number of pixels	2 073 600 pixels (1 920 x 1 080 dots)	1 024 000 pixels (1 280 x 800 dots)
Lens	Zoom	1.5 to 2.9:1	1.5 to 3.1:1
	Focus	F = 2.0 to 3.4 f = 21.5 mm to 43.0 mm	
Light source		Hybrid light source (LED / laser diode)	
Light output*1		3 500 lm (ANSI)	
Contrast ratio*1		10 000:1	
Supported scanning Frequency*2	For video signals	Horizontal: 15.75 kHz/15.63 kHz, Vertical: 50 Hz/60 Hz	
	For RGB signals	Horizontal: 15 kHz to 100 kHz, Vertical: 24 Hz to 120 Hz PIAS (Panasonic Intelligent Auto Scanning) system	
		Dot clock frequency 162 MHz or less	
	For YC _B C _R /YP _B P _R signals	<ul style="list-style-type: none"> • 525i (480i) Horizontal: 15.75 kHz, Vertical: 60 Hz • 525p (480p) Horizontal: 31.5 kHz, Vertical: 60 Hz • 750 (720)/60p Horizontal: 45 kHz, Vertical: 60 Hz • 1125 (1035)/60i Horizontal: 33.75 kHz, Vertical: 60 Hz • 1125 (1080)/50i Horizontal: 28.13 kHz, Vertical: 50 Hz • 1125 (1080)/24sF Horizontal: 27 kHz, Vertical: 48 Hz • 1125 (1080)/30p Horizontal: 33.75 kHz, Vertical: 30 Hz • 1125 (1080)/50p Horizontal: 56.25 kHz, Vertical: 50 Hz 	<ul style="list-style-type: none"> • 625i (576i) Horizontal: 15.63 kHz, Vertical: 50 Hz • 625p (576p) Horizontal: 31.25 kHz, Vertical: 50 Hz • 750 (720)/50p Horizontal: 37.5 kHz, Vertical: 50 Hz • 1125 (1080)/60i Horizontal: 33.75 kHz, Vertical: 60 Hz • 1125 (1080)/24p Horizontal: 27 kHz, Vertical: 24 Hz • 1125 (1080)/25p Horizontal: 28.13 kHz, Vertical: 25 Hz • 1125 (1080)/60p Horizontal: 67.5 kHz, Vertical: 60 Hz
	For DVI-D signal	525p (480p), 625p (576p), 750 (720)/60p, 750 (720)/50p, 1125 (1080)/60i, 1125 (1080)/50i, 1125 (1080)/24p, 1125 (1080)/24sF, 1125 (1080)/25p, 1125 (1080)/30p, 1125 (1080)/60p, 1125 (1080)/50p	
	For HDMI signal	<ul style="list-style-type: none"> • Displayable resolution: VGA to WUXGA (non-interlaced) WUXGA signal supports only VESA CVT-RB (Reduced Blanking) signal. • Dot clock frequency: 25 MHz to 162 MHz 	
		525p (480p), 625p (576p), 750 (720)/60p, 750 (720)/50p, 1125 (1080)/60i, 1125 (1080)/50i, 1125 (1080)/24p, 1125 (1080)/24sF, 1125 (1080)/25p, 1125 (1080)/30p, 1125 (1080)/60p, 1125 (1080)/50p	

*1 Measurement, measuring conditions and method of notation all comply with ISO21118 international standards.

*2 Refer to "List of compatible signals" (➔ page 122) for details on the types of video signals that can be used with the projector.

Chapter 6 Appendix — Specifications

Model No.	PT-RZ370EA	PT-RW330EA	
Color system	7 standards (NTSC/NTSC4.43/PAL/PAL-N/PAL-M/SECAM/PAL60)		
Projection screen size	1.02 m (40") - 7.62 m (300")		
Screen aspect ratio	16:9	16:10	
Projection method	[FRONT/CEILING], [FRONT/FLOOR], [REAR/CEILING], [REAR/FLOOR]		
Terminal	<COMPUTER IN> terminal	1 set, high-density D-Sub 15 p (female)	
		RGB signals 0.7 V [p-p] 75 Ω (SYNC ON GREEN: 1.0 V [p-p] 75 Ω) SYNC/HD TTL high impedance, automatic positive/negative polarity compatible VD TTL high impedance, automatic positive/negative polarity compatible (SYNC/HD and VD do not support 3 value SYNC.) YPbPr signals Y: 1.0 V [p-p] including synchronization signal, PbPr: 0.7 V [p-p] 75 Ω	
		1 set, DVI-I 29 p Digital signals Single link, DVI 1.0 compliant, HDCP compatible RGB signals 0.7 V [p-p] 75 Ω (SYNC ON GREEN: 1.0 V [p-p] 75 Ω) SYNC/HD TTL high impedance, automatic positive/negative polarity compatible VD TTL high impedance, automatic positive/negative polarity compatible YPbPr signals Y: 1.0 V [p-p] including synchronization signal, PbPr: 0.7 V [p-p] 75 Ω	
	<HDMI IN> terminal	1 set, HDMI 19 pin, HDCP compatible, Deep Color compatible Audio signal Linear PCM (Sampling frequency: 48 kHz/44.1 kHz/32 kHz)	
	<VIDEO IN> terminal	1 set, Pin jack 1.0 V [p-p] 75 Ω	
	<SERIAL IN> terminal	D-Sub 9 p, 1 set, RS-232C compliant, for computer control	
	<VARIABLE AUDIO OUT> terminal	1 set, M3 stereo mini jack (monitor output, with stereo support) 0 V [rms] to 1.8 V [rms] (variable), output impedance 2.2 kΩ or lower	
	<AUDIO IN> terminal	1 set, M3 stereo mini jack 0.5 V [rms], input impedance 22 kΩ or higher	
<DIGITAL LINK/LAN> terminal	1 set, RJ-45 network, for DIGITAL LINK connection, PLink compatible, 100Base-TX		
Power cable length	3.0 m (118-1/8")		
Outer case	Molded plastic		
Dimensions	Width: 455 mm (17-29/32") Height: 137 mm (5-13/32") (with minimum feet length) Depth: 415 mm (16-11/32") (including lens)		
Weight	Approx. 11 kg (24.3 lbs.) ^{*1}		
Noise level^{*2}	When [LIGHT POWER] is set to [NORMAL]: 35 dB When [LIGHT POWER] is set to [LOW]: 29 dB		
Operating environment	Operating environment temperature ^{*3} : 0 °C (32 °F) to 45 °C (113 °F) Operating environment humidity: 20 % to 80 % (no condensation)		
Remote control	Power supply	DC 3 V (AA/R6/LR6 battery x 2)	
	Operating range	Within 15 m (49'2") (when operated directly in front of signal receiver)	
	Weight	117 g (4.1 ozs.) (including batteries)	
	Dimensions	Width: 48 mm (1-7/8"), Height: 163 mm (6-13/32"), Depth: 24.5 mm (31/32")	

*1 Average value. Weight varies for each product.

*2 Measurement, measuring conditions and method of notation all comply with ISO21118 international standards.

*3 When using the projector at high altitudes (1 400 m (4 593') – 2 700 m (8 858') above sea level), the operating environment temperature will be 0 °C (32 °F) – 40 °C (104 °F). When the ambient temperature becomes 35 °C (95 °F) or higher, the output light may be reduced to protect the projector.

Note

- The model numbers of accessories and optional components are subject to change without notice.

Dimensions

Units: mm

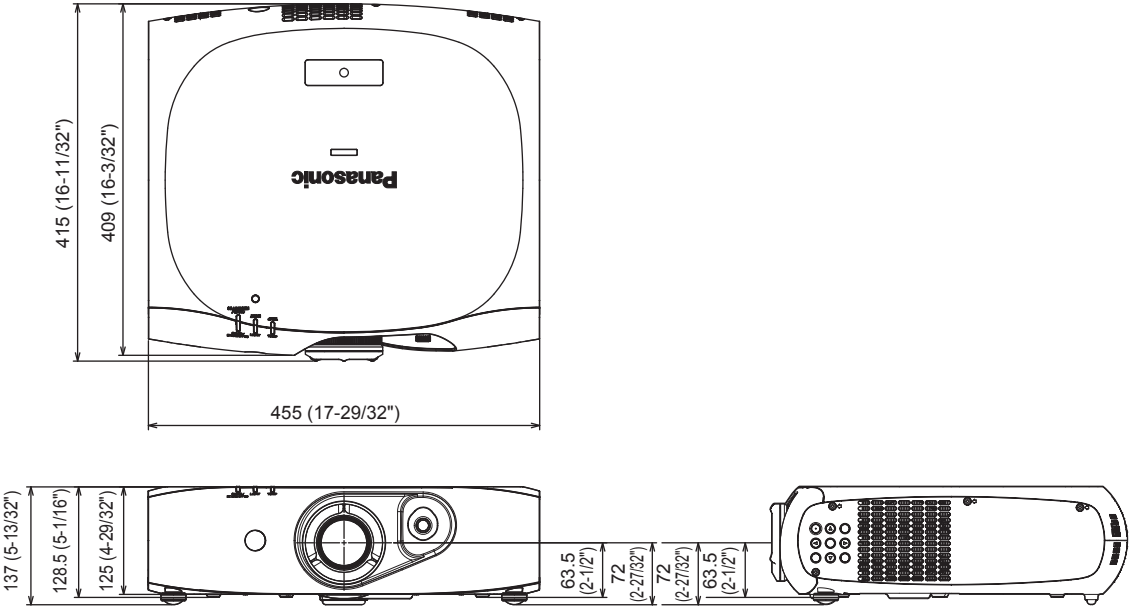

* Actual dimensions may differ depending on the product.

Ceiling mount bracket safeguards

- When installing the projector to a ceiling, be sure to use the specified ceiling mount bracket (Model No.: ET-PKR100H (for high ceilings), ET-PKR100S (for low ceilings)).
- When installing the projector, attach the drop-prevention kit included with the ceiling mount bracket.
- Request for a qualified technician to do the installation.
- Takes no responsibility for any damage to the projector resulting from use of a ceiling mount bracket not manufactured by Panasonic or the inappropriate choice of location for installation, even if the warranty period of the projector has not expired.
- Unused products must be removed promptly by a qualified technician.
- Use a torque screwdriver or Allen torque wrench to tighten bolts to their specified tightening torques. Do not use tools such as electric screwdrivers or impact screwdrivers.
- For details, read the installation manual that comes with the ceiling mount bracket.
- The model numbers of accessories and optional components are subject to change without notice.

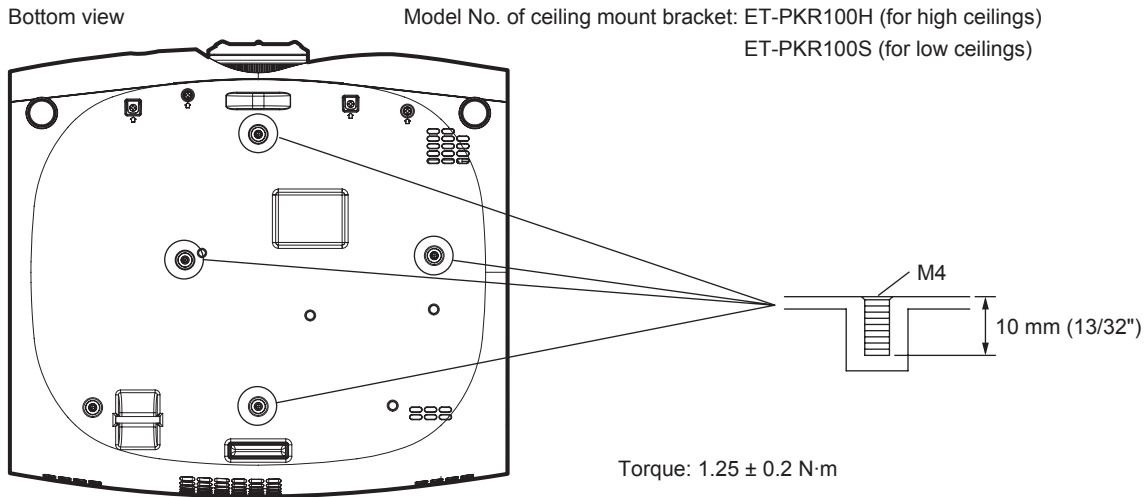

Index

- A**
- Accessories 17
 - <AC IN> terminal 21
 - Adjusting adjustable feet 27
 - [ADVANCED MENU] 44, 56
 - [ASPECT] 53
 - [AUDIO SETTING] 78
 - [AUTO SETUP] 62
 - <AUTO SETUP> button
 - Remote control 20, 39
 - Auto setup function 39
 - [AUTO SIGNAL] 62
 - [AV MUTE] 69
 - <AV MUTE> button
 - Remote control 20, 38
 - AV mute function 38
- B**
- [BACK COLOR] 67
 - [BLANKING] 56
 - [BRIGHTNESS] 48
- C**
- Cautions on use 16
 - Cautions when transporting 14
 - Ceiling mount bracket 127
 - Ceiling mount bracket safeguards 127
 - [CLAMP POSITION] 57
 - [CLOCK PHASE] 54
 - [CLOSED CAPTION SETTING] 66
 - [COLOR] 48
 - [COLOR MATCHING] 60
 - [COLOR TEMPERATURE] 48
 - <COMPUTER> button
 - Remote control 20
 - [COMPUTER IN] 62
 - Connecting the power cord 33
 - Connecting to a twisted-pair-cable transmitter 93
 - Connection 28
 - [CONTRAST] 47
 - [CONTROL DEVICE SETUP] 88
 - [COOLING CONDITION] 71
 - CRESTRON RoomView 92, 106
- D**
- [DATE AND TIME] 80
 - [DAYLIGHT VIEW] 50
 - <DEFAULT> button
 - Remote control 20, 43
 - Deleting the registered data 85
 - [DIGITAL CINEMA REALITY] 56
 - DIGITAL LINK 16, 108
 - <DIGITAL LINK> button
 - Remote control 20
 - [DIGITAL LINK INPUT] 76
 - [DIGITAL LINK MODE] 89
 - [DIGITAL LINK SETUP] 89
 - [DIGITAL LINK STATUS] 90
 - Dimensions 126
 - Display language 45, 59
 - [DISPLAY OPTION] 45, 60
 - Disposal 16
 - <DVI-I> button
 - Remote control 20, 39
 - [DVI-I IN] 63
- E**
- <ECO> button
 - Remote control 20, 40
 - [ECO MANAGEMENT] 71
 - <ENTER> button
 - Projector body 22
 - Remote control 20
- F**
- [FRAME RESPONSE] 58
 - [FREEZE] 68
 - <FREEZE> button
 - Remote control 20, 38
 - Freeze function 38
 - <FUNC1> to <FUNC3> buttons
 - Remote control 20, 40
 - Function button 40, 78
- H**
- <HDMI> button
 - Remote control 20, 39
 - [HDMI IN] 64
 - [HIGH ALTITUDE MODE] 71
- I**
- <ID ALL> button
 - Remote control 20, 23
 - <ID SET> button
 - Remote control 20, 23
 - [INITIALIZE] 82
 - Initial setting 19
 - [INITIAL STARTUP] 75
 - [INPUT RESOLUTION] 57
 - <INPUT SELECT> button
 - Projector body 22, 39
 - Installation precautions 14
- K**
- [KEystone] 55
- L**
- Light source indicator 110
 - List of compatible signals 122
 - [LOAD ALL USER DATA] 81
- M**
- Main menu 43
 - Main power switch 21, 34
 - Maintenance 112
 - <MENU> button
 - Projector body 22
 - Remote control 20
 - Menu item 44
 - [MENU LOCK] 87
 - [MENU LOCK PASSWORD] 87
- N**
- Navigating through the menu 42
 - [NETWORK] 46, 89
 - Network connections 92
 - [NETWORK CONTROL] 91
 - [NETWORK SETUP] 91
 - [NETWORK STATUS] 92
 - [NOISE REDUCTION] 50
- O**
- [ON-SCREEN DISPLAY] 64
 - On-screen menu 42
 - Optional accessories 18
- P**
- [PICTURE] 44, 47
 - [PICTURE MODE] 47
 - [POSITION] 44, 52
 - Power button
 - Projector body 22
 - Remote control 20
 - Power cord 33
 - Power indicator 33
 - Precautions for use 14
 - Projecting 36
 - [PROJECTION METHOD] 25, 70
 - [PROJECTOR ID] 70
 - [PROJECTOR SETUP] 45, 70
- R**
- [RASTER POSITION] 58
 - Read this first! 2
 - Registering a signal to the list 84
 - Remote control 20
 - Remote control operations 38
 - Renaming the registered signal 84
 - Resetting to the factory default 43
 - <RETURN> button
 - Projector body 22
 - Remote control 20
 - RoomView 106
 - [RS-232C] 76, 119
- S**
- [SAVE ALL USER DATA] 81
 - [SCHEDULE] 73
 - [SCREEN SETTING] 61
 - Security 15
 - [SECURITY] 46, 86
 - [SECURITY PASSWORD] 86
 - [SECURITY PASSWORD CHANGE] 86
 - Selecting the input signal 36
 - <SERIAL IN> terminal 119
 - [SERVICE PASSWORD] 82
 - Setting remote control ID numbers 23
 - Setting up 25
 - [SHARPNESS] 50
 - [SHIFT] 52
 - [SIGNAL LIST] 46, 84
 - Specifications 124
 - sRGB-compliant video 51
 - [STARTUP INPUT SELECT] 75
 - [STARTUP LOGO] 67
 - [STATUS] 80
 - [SUB MEMORY LIST] 68
 - Switching off the projector 35
 - Switching on the projector 34
 - Switching the input signal 39
 - [SYSTEM SELECTOR] 51
- T**
- Temperature indicator 111
 - [TEST PATTERN] 46, 83
 - [TEXT CHANGE] 87
 - [TEXT DISPLAY] 87
 - [TINT] 48
 - Troubleshooting 113
- V**
- <VIDEO> button
 - Remote control 20, 39
 - Volume adjustment 40
 - <VOLUME+>/<VOLUME-> button
 - Remote control 20, 40
- Z**
- [ZOOM] 53

Information for Users on Collection and Disposal of Old Equipment and used Batteries



These symbols on the products, packaging, and/or accompanying documents mean that used electrical and electronic products and batteries should not be mixed with general household waste. For proper treatment, recovery and recycling of old products and used batteries, please take them to applicable collection points, in accordance with your national legislation and the Directives 2002/96/EC and 2006/66/EC.

By disposing of these products and batteries correctly, you will help to save valuable resources and prevent any potential negative effects on human health and the environment which could otherwise arise from inappropriate waste handling.



For more information about collection and recycling of old products and batteries, please contact your local municipality, your waste disposal service or the point of sale where you purchased the items.

Penalties may be applicable for incorrect disposal of this waste, in accordance with national legislation.



For business users in the European Union

If you wish to discard electrical and electronic equipment, please contact your dealer or supplier for further information.

Information on Disposal in other Countries outside the European Union

These symbols are only valid in the European Union. If you wish to discard these items, please contact your local authorities or dealer and ask for the correct method of disposal.

Note for the battery symbol (bottom two symbol examples):

This symbol might be used in combination with a chemical symbol. In this case it complies with the requirement set by the Directive for the chemical involved.