



65-inch class Touch Screen LCD Display

TH-65BF1W

● Product specification (design and specification subject to change without notice)

■ DISPLAY

Screen Size (Diagonal)	65 inch (1638 mm)
Panel Type / Backlight	LCD VA panel / E-LED
Aspect Ratio	16:9
Effective Display Area (W x H)	1428 x 803 mm
Number of Pixels (H x V)	1920 x 1080 pixel
Brightness	350 cd/m ² (typ.)
Contrast Ratio	4000:1 (typ.)
Dynamic Contrast	50000:1
Response Time	6.5 ms (G to G)
Viewing Angle (Horizontal / Vertical)	178 degrees / 178 degrees (CR \geq 10)
Panel Life*	approx. 50000 hours (typ.)

* An approximate time until the panel brightness decreases to half of its original value.

■ TOUCH PANEL

Detection Method	Infrared blocking detection method
Touch operation	up to 12-point multi touch* ¹
OS	Windows (7 / 8.1 / 10) Mac (OS X 10.10 / 10.11, macOS Sierra)* ²

*¹ : When using the Whiteboard Software for Windows[®]. Up to 4-points when using the Built-in Whiteboard Software and Whiteboard Software for Mac.

*² : When using Mac Single touch.

• Windows is trademarks of Microsoft Corporation in the United States and other countries. Mac, Mac OS X, macOS are trademarks of Apple Inc., registered in the U.S. and other countries.

■ CONNECTION TERMINAL

HDMI IN	HDMI TYPE A connector x 2	Linear PCM (Sampling frequency : 48 kHz/44.1 kHz/32 kHz)
COMPONENT/RGB IN	BNC x 1 set	Y/G : BNC Contact Plug with sync 1.0 Vp-p (75 Ω) Pb/Cb/B : BNC Contact Plug without sync 0.7 Vp-p (75 Ω) Pr/Cr/R : BNC Contact Plug without sync 0.7 Vp-p (75 Ω)
AUDIO IN	Stereo mini jack (M3) x 1 (Shared with VIDEO IN)	0.5 V rms
VIDEO IN	BNC x 1	1.0 V p-p (75 Ω)
AUDIO IN	Stereo mini jack (M3) x 1 (Shared with COMPONENT / RGB IN)	0.5 V rms
DVI-D IN	DVI-D 24-pin x 1	Compliance with DVI Revision 1.0 Compatible with HDCP 1.1
AUDIO IN	Stereo mini jack (M3) x 1 (Shared with PC IN)	0.5 V rms
PC IN	Mini D-sub 15 pin (DDC2B) x 1	Y/G : with sync 1.0 Vp-p (75 Ω) : without sync 0.7 Vp-p (75 Ω) Pb/Cb/B : without sync 0.7 Vp-p (75 Ω) Pr/Cr/R : without sync 0.7 Vp-p (75 Ω) HD/VD : TTL (high impedance)
AUDIO IN	Stereo mini jack (M3) x 1 (Shared with DVI-D IN)	0.5 V rms
PC OUT	Mini D-Sub 15-pin x 1	R : 0.7 V p-p (75 Ω) G : 0.7 V p-p (75 Ω) B : 0.7 V p-p (75 Ω) HD/VD : 3.5~5.0 V p-p
SERIAL IN	D-sub 9pin x 1, RS-232C Compatible	
DIGITAL LINK/LAN	RJ45 x 1, 100BASE-TX, Compatible with PLink	
External Speaker	8 Ω , 20 W [10 W + 10 W] (10 %THD)	
USB A	TYPE A USB connector x 1 (For Memory Viewer)	
USB B	TYPE B USB connector x 1 (For Touch panel)	
Function Slot : SLOT2.0	1 (Vacant)	

■ AUDIO

Built in Speaker	10 W 8 Ω , Full Range : 120 mm x 40 mm x 2
Speaker	20 W [10 W + 10 W] (10 %THD)

■ ELECTRICAL

Power Requirements	220-240 V AC 50 / 60 Hz
Power Consumption	215 W
On Mode Average Power Consumption*	approx. 165 W
Power Off Condition	approx. 0.3 W
Stand-by Condition	approx. 0.5 W
Apparent power	approx. 215 VA

* Based on IEC 62087 Ed.2 measurement method.

■ MECHANICAL

Dimensions (W x H x D)	1517 x 892 x 108 mm
Bezel Width	T/R/L/B approx. 39 mm
Carton Dimensions (W x H x D)	1720 x 1027 x 286 mm
Weight	approx. 58 kg
Gross Weight	approx. 68 kg
Cabinet Material / Color	Aluminum / Black
Pitch for Wall-Hanging	684 x 300 mm (Installed by: M8 screws / Screw hole depth 15 - 20 mm)
Protection Glass Thickness	approx. 2.9 mm / Anti Glare

■ INSTALLATION REQUIREMENT

Orientation	Landscape / Portrait
Tilting Angle	Up to 45 degrees backward in landscape orientation

* Please contact your sales representative with regard to the tilt angle before installation.

* When installing the display on portrait setting, be sure to install with the power indicator at the top side of the display.

MAIN FEATURE

Quick menu	Yes
CUD	Yes
Easy Whiteboard Functions*1	Yes
Memory Viewer	<ul style="list-style-type: none"> Picture <ul style="list-style-type: none"> Extension :JPG, JPEG, BMP Format :Maximum resolution 8000 x 8000 Bit numbers (Bit depth): up to 24 bit Video <ul style="list-style-type: none"> Extension :mov, avi, mp4, mpg, mpeg, wmv Video format :Maximum 1920 x 1080/30fps Video bitrate :up to 40M bps Audio format :Maximum 48 kHz 2ch Audio bitrate :up to 384k bps
Wireless Connections	Yes (Wireless Display (Miracast) / Panasonic Application)
DIGITAL LINK	Yes
Secondary Display	Yes
Picture in Picture	Yes
Digital Zoom	Yes
1:1Pixel Mode	Yes
Auto Set Up	Yes
Power Management	Yes
Power Management (PC / DVI-D)	Yes
Input Lock	Yes
Button / Input lock	Yes
Remote-control User Level	Yes
Input Search	Yes
Operating Time*2	18h/day

*1 For e-mail sending function, can be sent as JPEG format only. Supported mail servers using SSL or STARTTLS.
 *2 In case of running for a long time, the moving image is recommended to be displayed. If you display a still picture for an extended period, the image retention might remain on the screen. However, image retention can gradually disappear by displaying movie images.
 Note: This spec sheet describes a part of the function. Please refer to the operating instructions about the other functions.

INCLUDED ACCESSORIES

- AC cord (2 m) - Remote Control Transmitter
- Batteries for the Remote Control Transmitter (R6 (UM) Size x 2)
- Software CD-ROM (Whiteboard software / Wireless Manager software / Operating Instruction) x 1 - USB Cable (2.8 m) x 1
- Screw x 2 - Clamper x 1 - Pen x 2 - Eraser x 1 - Pen Stand x 1
- Operating Instruction book

STANDARD (CERTIFICATIONS)

SAFETY REGULATIONS	CE, IEC60065
RADIATION REGULATIONS	AS/NZS CISPR32:2013 RCM Mark

DIMENSIONS

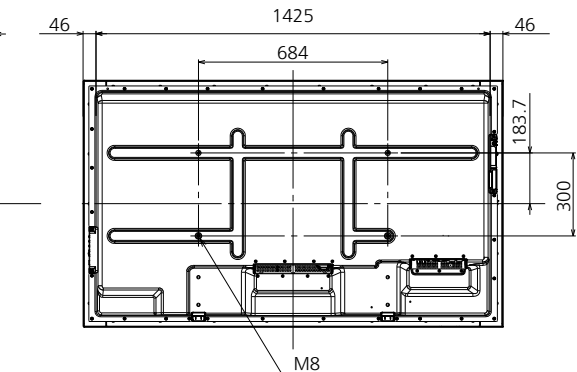
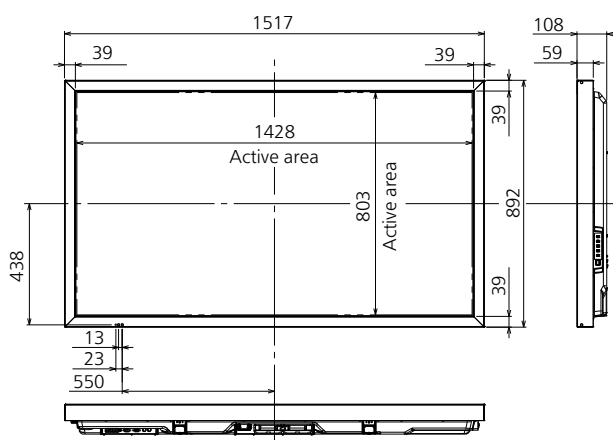

Cautions: This drawing is not a scale
Units : mm

CONNECTION TERMINAL

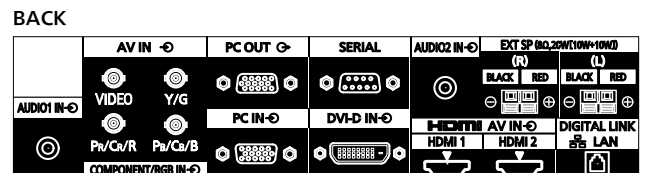

ENVIRONMENTAL

Operating Environment	Temperature: 0 °C to 40 °C*1
	: 0 °C to 35 °C*2
	Humidity : 20 % to 80 % (No condensation)
Storage Environment	Altitude : 0 to 2800 m
	Temperature : -20 °C to 60 °C
	Humidity : 20 % to 80 % (Non condensation)

*1 for up to 1400 m altitude
 *2 for between 1400 m and 2800 m altitude Depending on the temperature or humidity conditions, uneven brightness may be observed. This is not a malfunction.
 • This unevenness will disappear while applying current continuously. If not, consult the distributor.

REMOTE CONTROL TRANSMITTER

Power Requirements	DC 3 V (2 x AA Size batteries)
Operating distance	approx. 7 m*
Weight	approx. 60 g Does not include battery
Dimensions (W x H x D)	48 x 136 x 24 mm

*When operated directly in front of receptor.

BUILT-IN WIRELESS LAN FUNCTION

Standard	2.4 GHz: IEEE802.11b/g/n, 5.0 GHz: IEEE802.11a/n
Infrastructure Mode	WPA2-PSK (TKIP / AES), WPA-PSK (TKIP / AES), WEP (64-bit / 128-bit), WPA-EAP / WPA2-EAP (PEAP [MS-CHAPv2 / GTC] / EAP-FAST [MS-CHAPv2 / GTC] / EAP-TTLS [MD5 / MS-CHAPv2], 128-bit / 64-bit)

OPTIONAL ACCESSORIES

Pedestal Stand	TY-ST65P20*1
Mobile Stand	TY-ST65PB2
Wall-Hanging bracket	TY-WK65PR20*2
Early Warning Software	ET-SWA100
HD-SDI Terminal Board with Audio	TY-FB10HD
Dual Link HD-SDI Terminal Board	TY-FB11DHD
DVI-D Terminal Board	TY-FB11DD
Digital Interface Box	ET-YFB100G
DIGITAL LINK Switcher	ET-YFB200G
Easy Wireless Stick	ET-UW100W*3

*1 Production discontinued. (stock is limited)
 *2 When used with TH-65BF1, only vertical mounting is supported.
 *3 This product can be purchased in the U.S., Canada, Japan, Australia and New Zealand.

● Applicable Input Signals

V : VIDEO
R : D-sub RGB
Y : YCbCr/Y/PbPr

D : DVI-D
H : HDMI
DL : DIGITAL LINK

■ Picture signal form

Correspondence signal	Resolution dot	Scan rate		Dot clock rate (MHz)	Input format	SignalName
		Horizontal (kHz)	Vertical (Hz)			
NTSC/NTSC4.43/ PAL-M/PAL60	720 x 480i	15.73	59.94	13.50	V	NTSC
PAL/PAL-N/SECAM	720 x 576i	15.63	50.00	13.50	V	PAL
525i (480i)	720 x 480i	15.73	59.94	13.50	R/Y	525/60i (Analog)
625i (575i)	720 x 575i	15.63	50.00	13.50	R/Y	625/50i (Analog)
525i (480i)	720 (1440) x 480i*2	15.73	59.94	27.00	D/H/DL	525/60i (Digital)
625i (576i)	720 (1440) x 576i*2	15.63	50.00	27.00	D/H/DL	625/50i (Digital)
525p (480p)	720 x 480	31.47	59.94	27.00	R/Y/D/H/DL*5	525/60p
625p (575p)	720 x 575	31.25	50.00	27.00	R/Y	
625p (576p)	720 x 576	31.25	50.00	27.00	D/H/DL	625/50p (576/50p)
750 (720)/60p	1280 x 720	45.00	60.00	74.25	R/Y/D/H/DL	750/60p
750 (720)/50p	1280 x 720	37.50	50.00	74.25	R/Y/D/H/DL	750/50p
1125 (1080)/60i*1	1920 x 1080i	33.75	60.00	74.25	R/Y/D/H/DL	1125/60i
1125 (1080)/50i	1920 x 1080i	28.13	50.00	74.25	R/Y/D/H/DL	1125/50i
1125 (1080)/24p	1920 x 1080	27.00	24.00	74.25	R/Y/D/H/DL	1125/24p
1125 (1080)/24PsF	1920 x 1080i	27.00	48.00	74.25	R/Y	1125/24PsF
1125 (1080)/25p	1920 x 1080	28.13	25.00	74.25	R/Y/D	1125/25p
1125 (1080)/30p	1920 x 1080	33.75	30.00	74.25	R/Y/D	1125/30p
1125 (1080)/60p	1920 x 1080	67.50	60.00	148.50	R/Y/D/H/DL	1125/60p
1125 (1080)/50p	1920 x 1080	56.25	50.00	148.50	R/Y/D/H/DL	1125/50p
1250 (1080)/50i	1920 x 1080i	31.25	50.00	74.25	R/Y	
2048 x 1080/24PsF	2048 x 1080i	27.00	48.00	74.25	*8	
2048 x 1080/24p	2048 x 1080	27.00	24.00	74.25	*8	

■ PC signal form

Correspondence signal	Resolution dot	Scan rate		Dot clock rate (MHz)	Input format	SignalName
		Horizontal (kHz)	Vertical (Hz)			
640 x 400*4	640 x 400	31.46	70.07	25.17	R/Y	VGA70
640 x 480*4	640 x 480	31.47	59.94	25.18	R/Y/D/H/DL*6	VGA60
		35.00	66.67	30.24	R/Y	
		37.86	72.81	31.50	R/Y	VGA72
		37.50	75.00	31.50	R/Y	VGA75
		43.27	85.01	36.00	R/Y	VGA85
800 x 600*4	800 x 600	35.16	56.25	36.00	R/Y	SVGA56
		37.88	60.32	40.00	R/Y/D/H/DL	SVGA60
		48.08	72.19	50.00	R/Y	SVGA72
		46.88	75.00	49.50	R/Y	SVGA75
		53.67	85.06	56.25	R/Y	SVGA85
832 x 624*4	832 x 624	49.72	74.54	57.28	R/Y	MAC16
852 x 480*4	852 x 480	31.47	59.94	33.54	R/Y*6	
				34.24	D/H/DL	WVGA60
1024 x 768*4	1024 x 768	39.55	50.00	51.89	D/H/DL	XGA50
		48.36	60.00	65.00	R/Y/D/H/DL	XGA60
		56.48	70.07	75.00	R/Y	XGA70
		60.02	75.03	78.75	R/Y	XGA75
		68.68	85.00	94.50	R/Y	XGA85
1066 x 600*4	1066 x 600	37.64	59.94	53.00	R/Y/D/H/DL	WSVGA60
1152 x 864*4	1152 x 864	53.70	60.00	81.62	D/H/DL	XGA+
		67.50	75.00	108.00	R/Y	1152x864_75Hz
1152 x 870*4	1152 x 870	68.68	75.06	100.00	R/Y	MAC21
1280 x 768*4	1280 x 768	47.70	60.00	80.14	R/Y	WXGA60_GTF
1280 x 800*4	1280 x 800	49.31	59.91	71.00	R/Y/D/H/DL	VESA1280RB
		49.70	59.81	83.50	R/Y/D/H/DL	VESA1280CVT
1280 x 960*4	1280 x 960	60.00	60.00	108.00	R/Y	Quad_VGA_60
		85.94	85.00	148.50	R/Y	Quad_VGA_85
		63.98	60.02	108.00	R/Y/D/H/DL	SXGA60
1280 x 1024*4	1280 x 1024	79.98	75.03	135.00	R/Y	SXGA75
		91.15	85.02	157.50	R/Y	SXGA85
		39.55	50.00	69.92	D/H/DL	WXGA50
1366 x 768*4	1366 x 768	48.36	60.00	86.71	R/Y/D/H/DL	WXGA60
1400 x 1050	1400 x 1050	65.22	60.00	122.61	D/H/DL	SXGA+60GTF
1440 x 900*4	1440 x 900	55.47	59.90	88.75	R/Y/D/H/DL	1440x900/60RB
		55.93	59.89	106.50	R/Y/D/H/DL	1440x900/60GTF
1600 x 1200*4	1600 x 1200*3	75.00	60.00	162.00	R/Y/D/H/DL	UXGA60
	1600 x 1200*3	81.25	65.00	175.50	R/Y	
1920 x 1080*4	1920 x 1080	67.50	60.00	148.50	R/Y/D/H/DL*7	1920x1080/60TV
1920 x 1200	1920 x 1200*3	74.04	59.95	154.00	D/H/DL	WUXGA60RB

*1: When 1125 (1035)/60i signal is input, it is displayed as 1125 (1080)/60i signal.

*2: Pixel-Repetition signal (dot clock frequency 27.0 MHz) only

*3: Displayed with image elements thinned out in the image processing circuit.

*4: The picture may not be displayed correctly with the PC signal from COMPONENT IN/RGB IN inputs.

*5: When selected the RGB format and 525p signal input to the PC IN terminal, it is recognized as VGA 60 Hz signal.

Note: Signals without above specification may not be displayed properly.

*6 When inputted VGA 60 Hz format signal from the other than PC IN terminal, it is recognized as 525p signal.

*7 When the signal is input to the PC IN, RGB IN and COMPONENT IN terminal, it is recognized as 1125 (1080)/60p signal.

*8 These signals can be received when the Dual Link HD-SDI Terminal Board (TY-FB11DHD) is installed.

Drawing of terminals

View from back

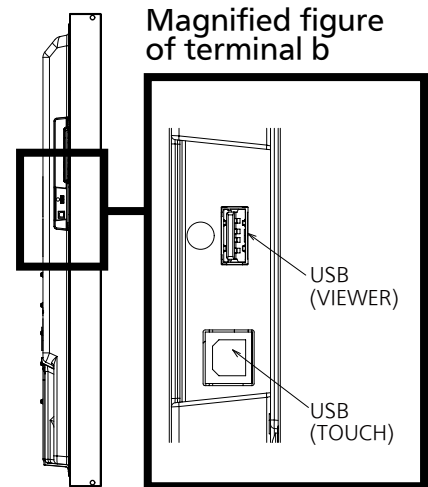
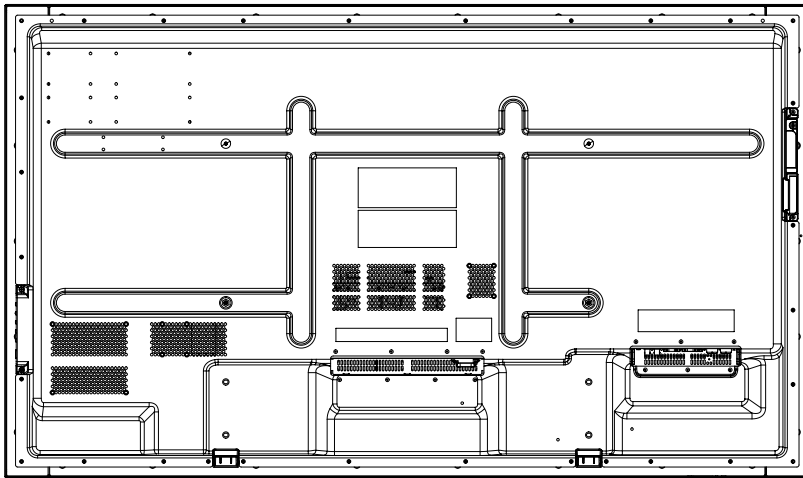

Magnified figure of terminal a

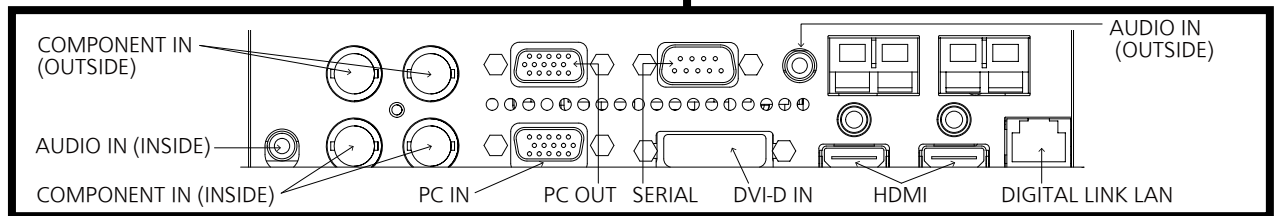

Sectional view of terminal a

OUTSIDE: COMPONENT IN/PC OUT/SERIAL/AUDIO IN
 INSIDE: AUDIO IN/COMPONENT IN/PC IN/DVI-D IN/HDMI/DIGITAL LINK LAN

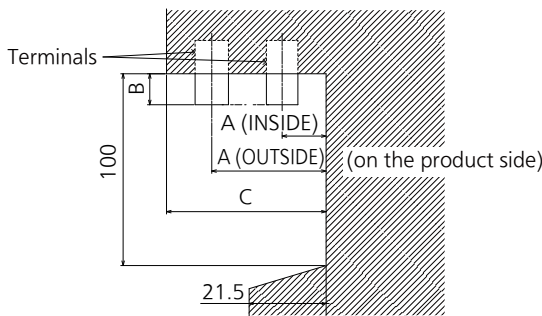

Terminal a

65BF1 Terminal (Bottom)

Units : mm

	COMPONENT IN (OUTSIDE)	COMPONENT IN (INSIDE)	AUDIO IN (OUTSIDE)	AUDIO IN (INSIDE)	PC OUT (OUTSIDE)	PC IN (INSIDE)	SERIAL	DVI-D IN	HDMI	DIGITAL LINK LAN
A	26.2	9.2	28.1	9.2	28.3	7.4	28.7	8.0	6.4	8.9
B	12.0	12.0	2.0	2.0	5.1	5.1	5.1	5.2		
C	41.5									

Sectional view of terminal b

USB (VIEWER)/USB (TOUCH)

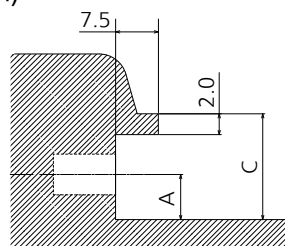

Terminal b

65BF1 Terminal (Side)

Units : mm

	USB (VIEWER)	USB (TOUCH)
A	8.4	9.8
B		
C	23.3	

* Due to the construction of terminal, some types of connecting cable or USB memory device cannot be used.
 Be sure to use connecting cable or USB memory device after confirmation in this drawing.