

No.	品名	Part Name	Material	Process · Remark
1	上ケース	Upper case	PC+ABS	Sail White
2	下ケース	Lower case	PC+ABS	Sail White · Printing
3	スライドカバー	Slide cover	PC+ABS	Sail White
4	ALCレンズコネクタ	ALC Lens Connector		
5	フロントパネル	Front panel	ABS	Black
6	SDメモリーカードスロット	SD memory card slot		
7	SD ON/OFFボタン	SD ON/OFF button		
8	オートバックフォーカスボタン(ABF)	Auto Back Focus button		
9	SD MOUNTランプ	SD MOUNT indicator		
10	リアパネル	Rear panel	PC	Printing(Black · White)
11	ネットワーク端子RJ45	Network Connector RJ45		
12	DC12V 入力端子	12V DC power supply terminal		
13	RS485端子	RS485 Terminal		
14	SD ERROR/ABFランプ	SD ERROR/ABF indicator		
15	INITIAL SETボタン (NTSC/PAL切替)	INITIAL SET button		
16	ACTランプ	ACT indicator		
17	LINKランプ	LINK indicator		
18	MONITOR OUT 端子	Monitor out terminal		
19	オーディオ入力端子	Audio input connector		
20	オーディオ出力端子	Audio output connector		
21	外部 I/O 端子	EXT I/O terminals		
22	保護シート	Cover film		
23	主銘版	ENGRAVE PLATE	Polyester Film	Printing
24	シリアルNo.ラベル	Serial number label	Polyester Film	Printing
25	MACアドレスラベル	MAC address label	Polyester Film	Printing
26	データマトリクスラベル	Date matrix label	Polyester Film	Printing

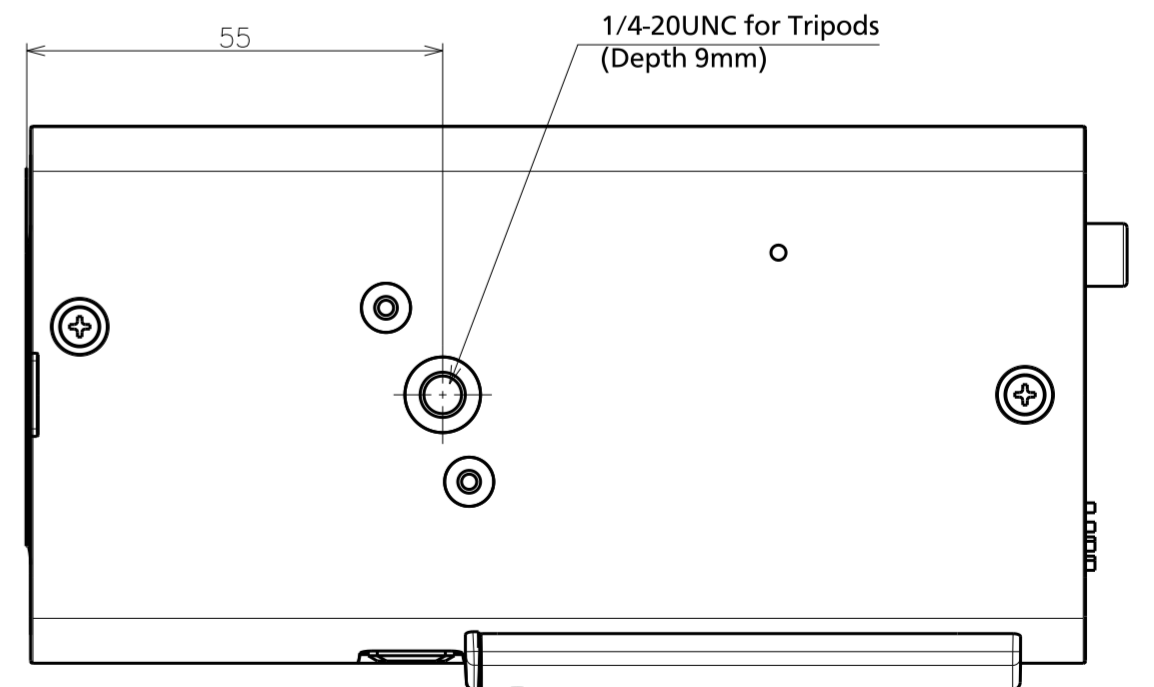

WV-S1132

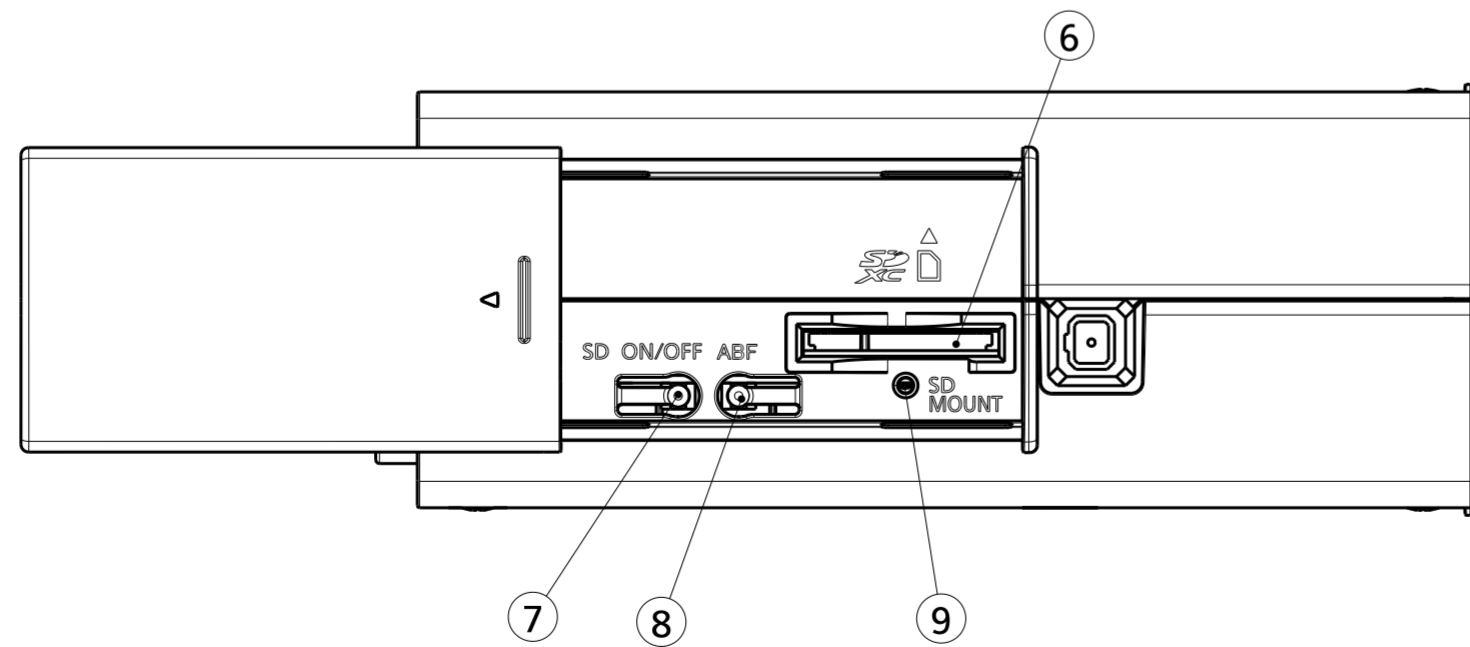
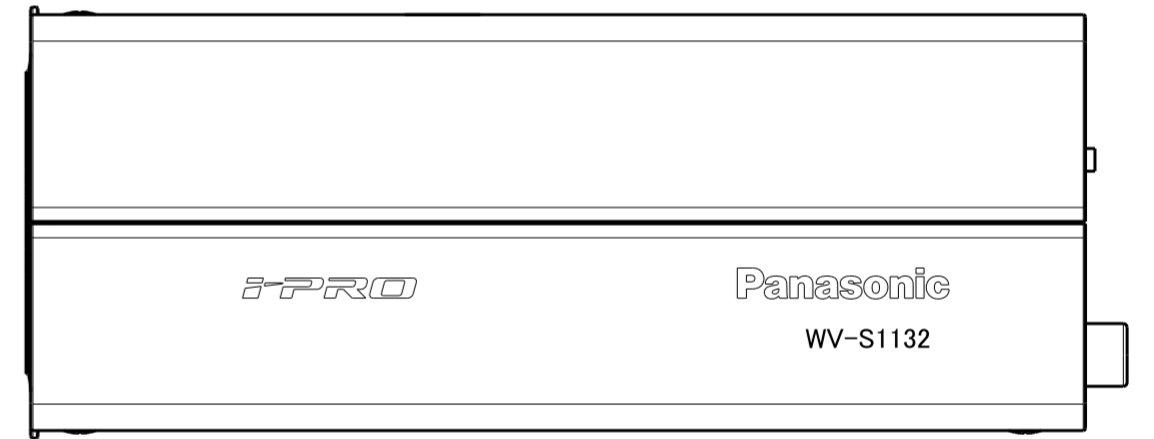
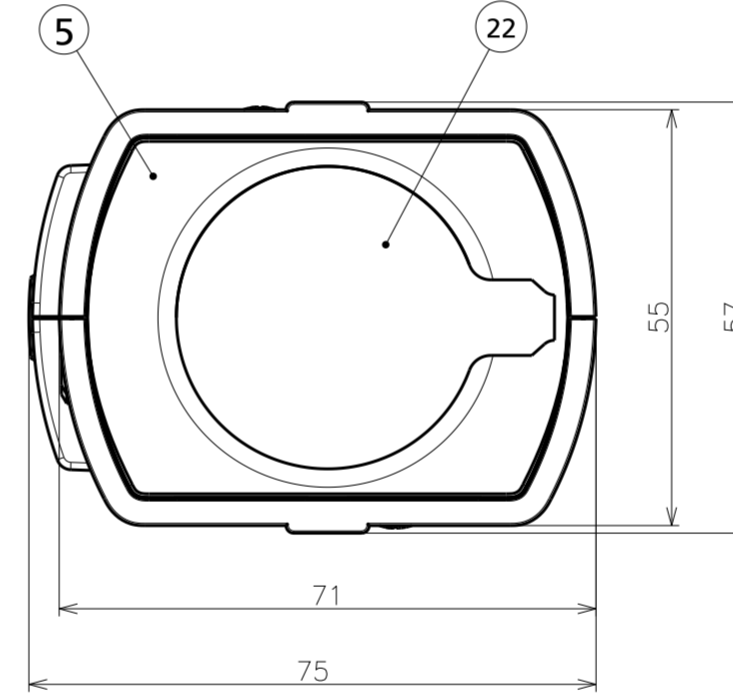
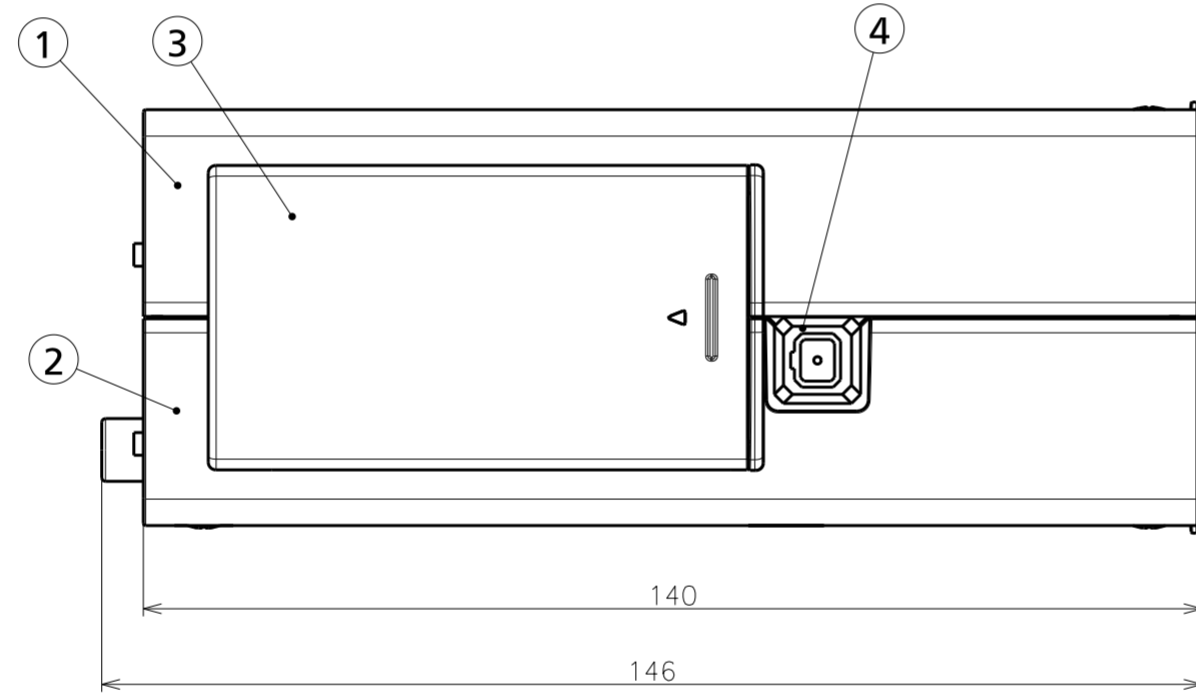
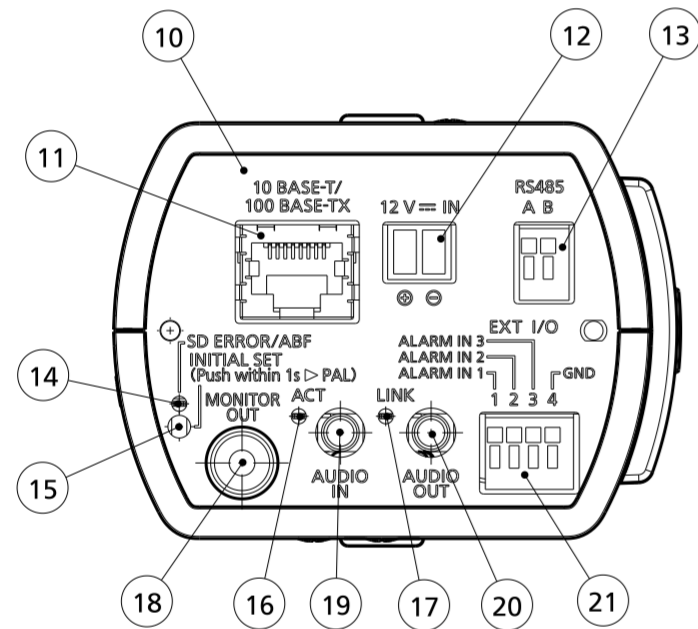
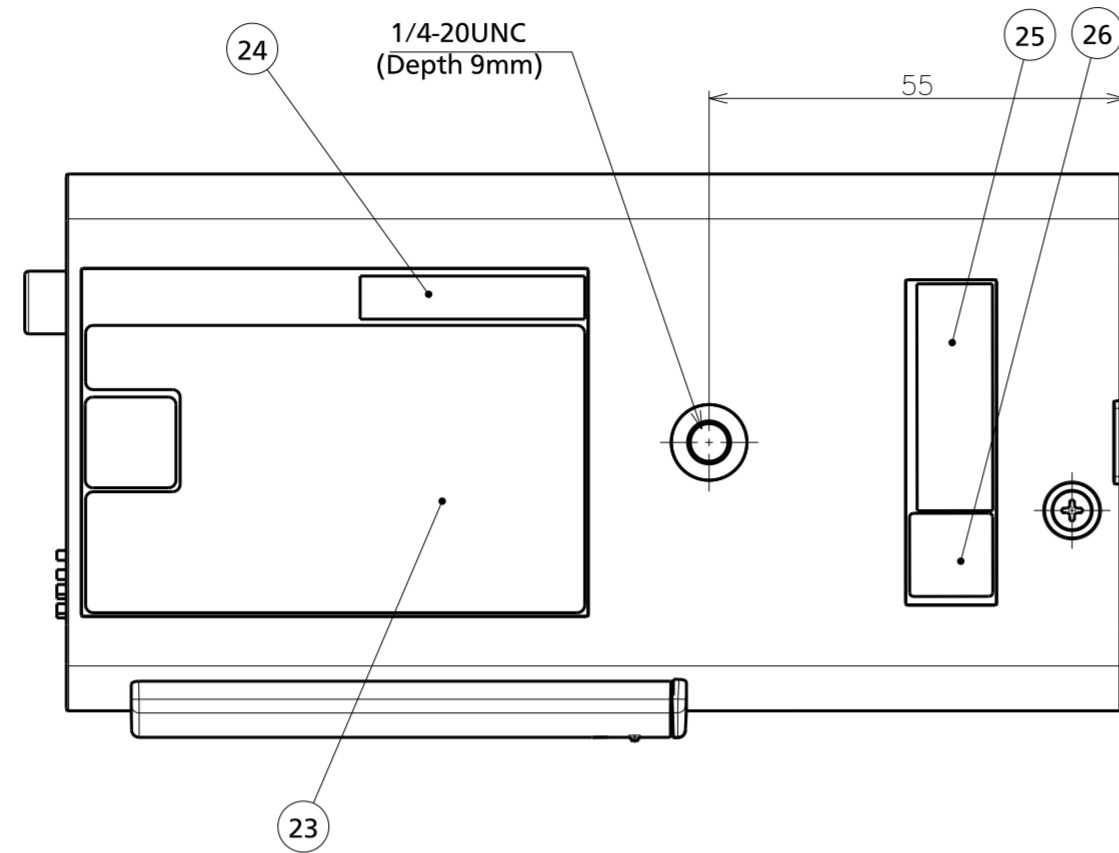
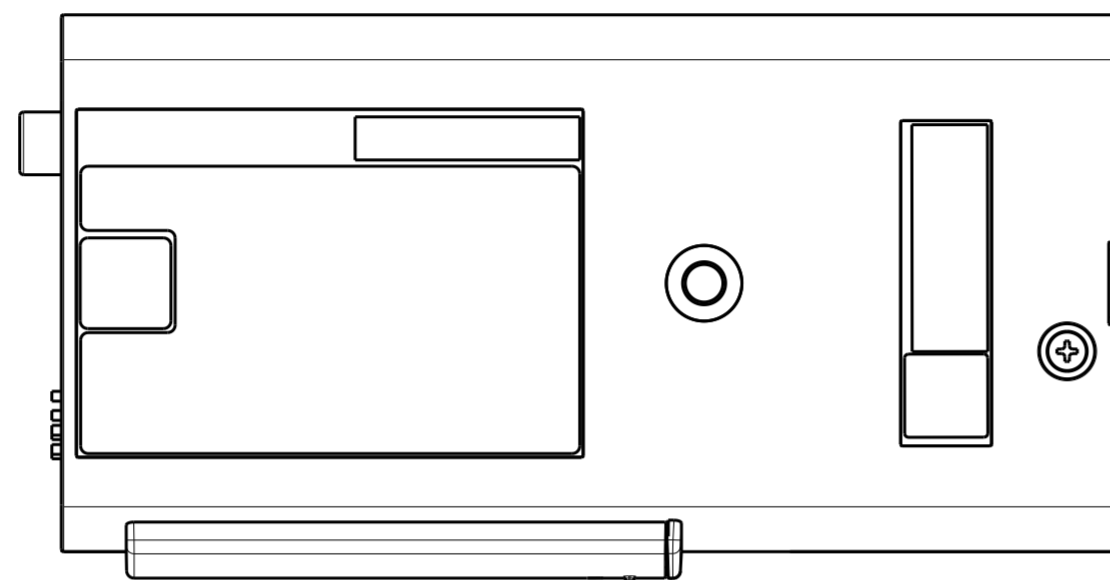

No.	品名	Part Name	Material	Process · Remark
1	三脚取付座	Tripod mount base	PC+ABS	Sail White

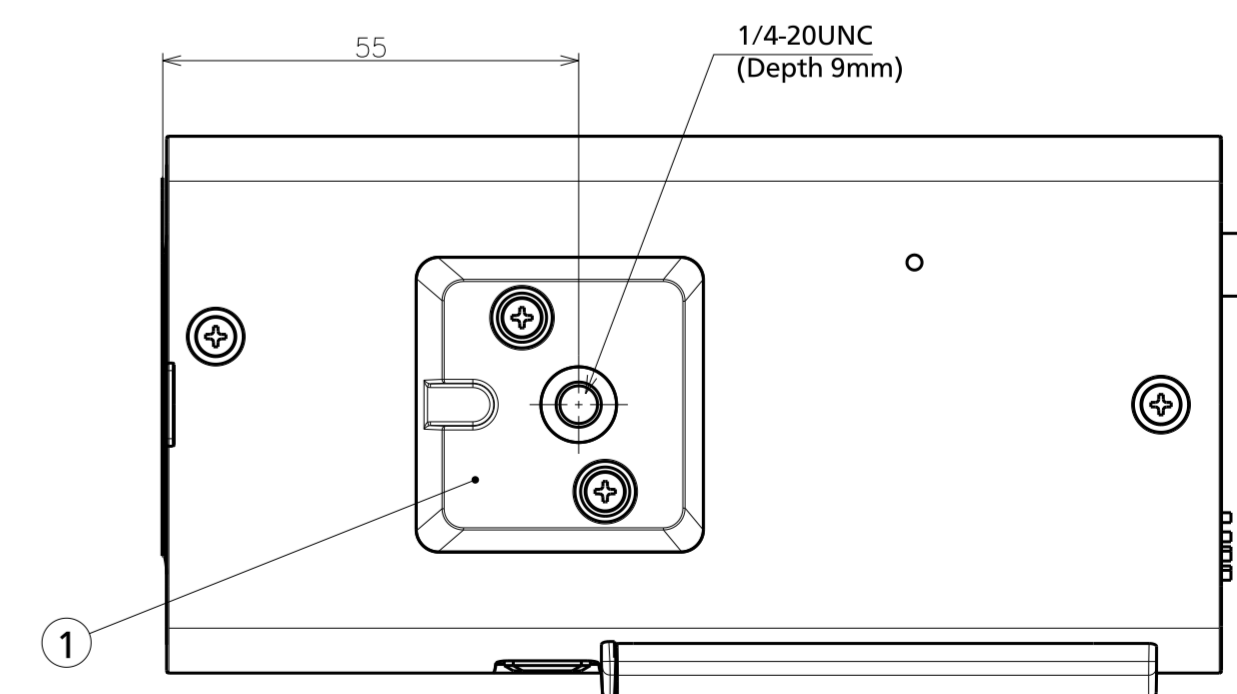
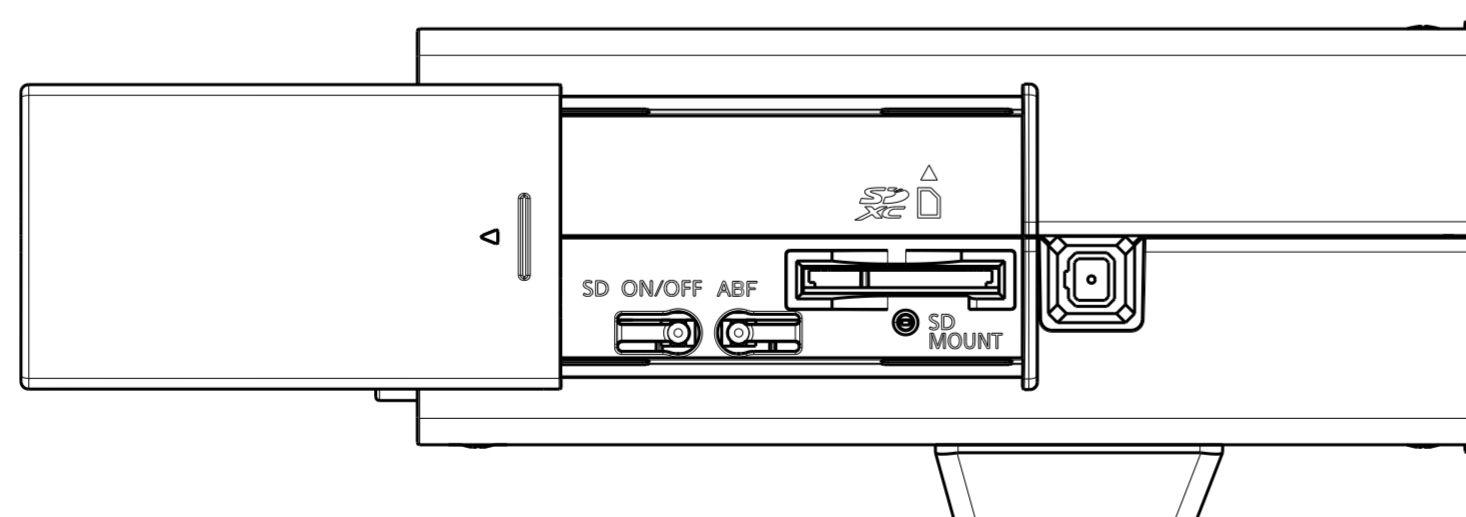
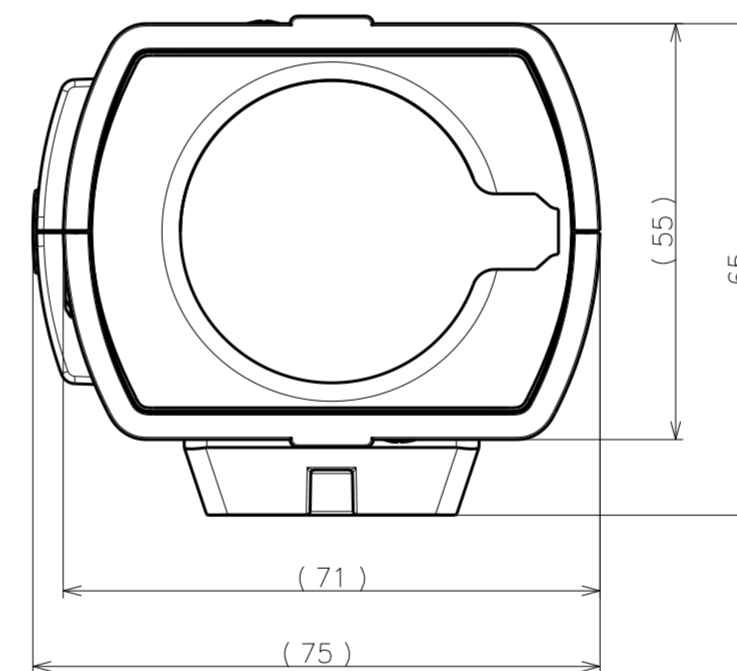
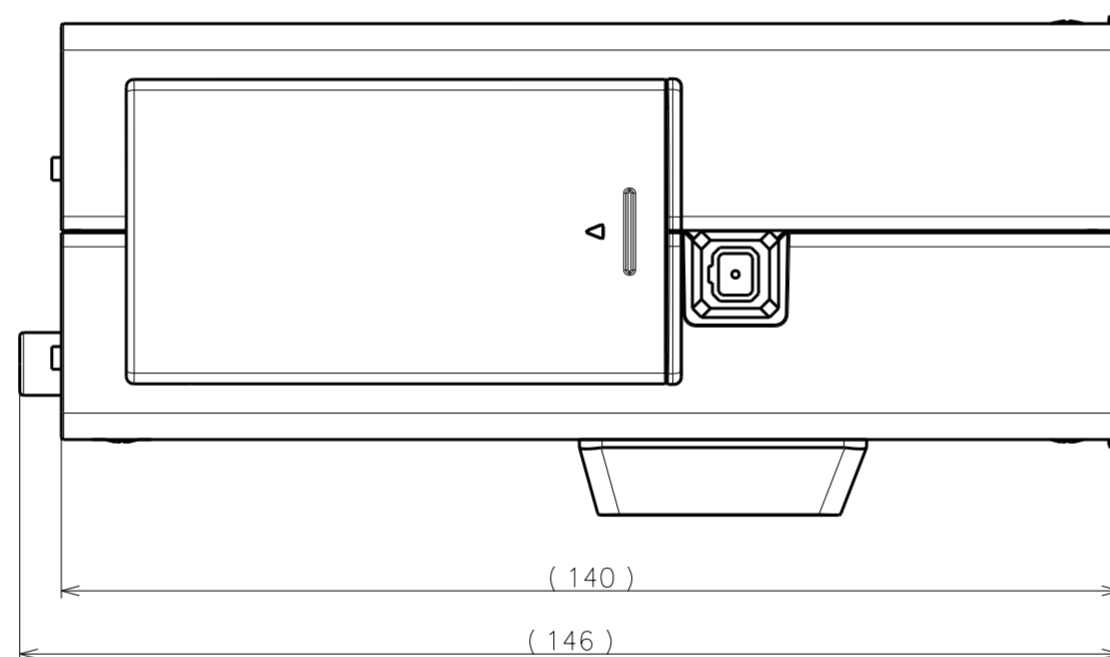
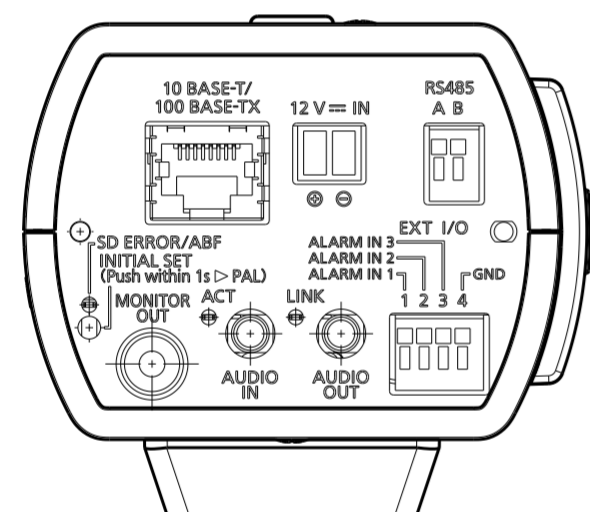

WV-S1132