

Panasonic®

Network camera Installation Guide

Model No. **WV-NW964**

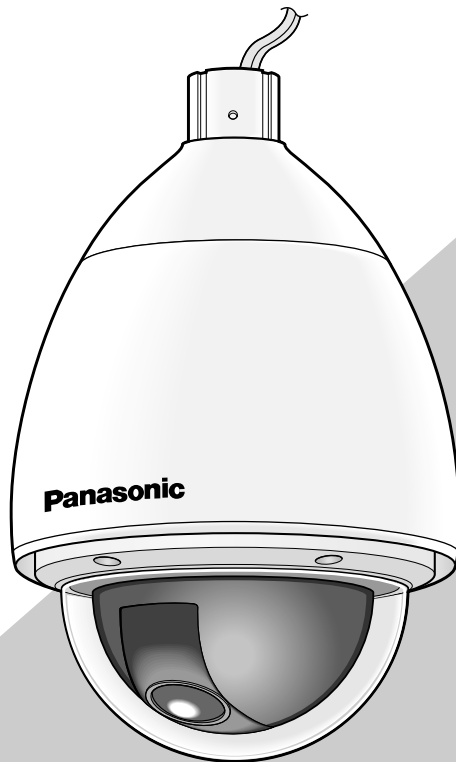

mini
SD

Before attempting to connect or operate this product,
please read these instructions carefully and save this manual for future use.

WARNING:

- This apparatus must be earthed.
- All work related to the installation of this product should be made by qualified service personnel or system installers.
- The connections should comply with local electrical code.

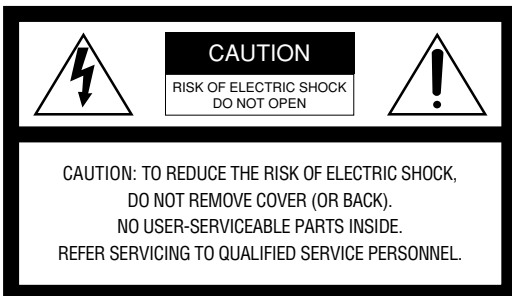

SA 1965

The lightning flash with arrowhead symbol, within an equilateral triangle, is intended to alert the user to the presence of uninsulated "dangerous voltage" within the product's enclosure that may be of sufficient magnitude to constitute a risk of electric shock to persons.



SA 1966

The exclamation point within an equilateral triangle is intended to alert the user to the presence of important operating and maintenance (servicing) instructions in the literature accompanying the appliance.

— For Canada —

This Class A digital apparatus complies with Canadian ICES-003.

— For U.S.A —

NOTE: This equipment has been tested and found to comply with the limits for a Class A digital device, pursuant to Part 15 of the FCC Rules. These limits are designed to provide reasonable protection against harmful interference when the equipment is operated in a commercial environment. This equipment generates, uses, and can radiate radio frequency energy and, if not installed and used in accordance with the instruction manual, may cause harmful interference to radio communications.

Operation of this equipment in a residential area is likely to cause harmful interference in which case the user will be required to correct the interference at his own expense.

FCC Caution: To assure continued compliance, (example - use only shielded interface cables when connecting to computer or peripheral devices). Any changes or modifications not expressly approved by the party responsible for compliance could void the user's authority to operate this equipment.

— For U.S.A —

The serial number of this product may be found in the unit. You should note the model number and serial number of this unit in the space provided and retain this book as a permanent record of your purchase to aid identification in the event of theft.

Model No. _____

Serial No. _____

Important safety instructions

- 1) Read these instructions.
- 2) Keep these instructions.
- 3) Heed all warnings.
- 4) Follow all instructions.
- 5) Clean only with dry cloth.
- 6) Do not block any ventilation openings. Install in accordance with the manufacturer's instructions.
- 7) Do not install near any heat sources such as radiators, heat registers, stoves, or other apparatus (including amplifiers) that produce heat.
- 8) Do not defeat the safety purpose of the polarized or grounding-type plug. A polarized plug has two blades with one wider than the other. A grounding type plug has two blades and a third grounding prong. The wide blade or the third prong are provided for your safety. If the provided plug does not fit into your outlet, consult an electrician for replacement of the obsolete outlet.
- 9) Protect the power cord from being walked on or pinched particularly at plugs, convenience receptacles, and the point where they exit from the apparatus.
- 10) Only use attachments/accessories specified by the manufacturer.
- 11) Use only with the cart, stand, tripod, bracket, or table specified by the manufacturer, or sold with the apparatus. When a cart is used, use caution when moving the cart/apparatus combination to avoid injury from tip-over.



- 12) Unplug this apparatus during lightning storms or when unused for long periods of time.

Limitation of liability

THIS PUBLICATION IS PROVIDED "AS IS" WITHOUT WARRANTY OF ANY KIND, EITHER EXPRESS OR IMPLIED, INCLUDING BUT NOT LIMITED TO, THE IMPLIED WARRANTIES OF MERCHANTABILITY, FITNESS FOR ANY PARTICULAR PURPOSE, OR NON-INFRINGEMENT OF THE THIRD PARTY'S RIGHT.

THIS PUBLICATION COULD INCLUDE TECHNICAL INACCURACIES OR TYPOGRAPHICAL ERRORS. CHANGES ARE ADDED TO THE INFORMATION HEREIN, AT ANY TIME, FOR THE IMPROVEMENTS OF THIS PUBLICATION AND/OR THE CORRESPONDING PRODUCT (S).

Disclaimer of warranty

IN NO EVENT SHALL MATSUSHITA ELECTRIC INDUSTRIAL CO.,LTD. BE LIABLE TO ANY PARTY OR ANY PERSON, EXCEPT FOR REPLACEMENT OR REASONABLE MAINTENANCE OF THE PRODUCT, FOR THE CASES, INCLUDING BUT NOT LIMITED TO BELOW:

- (1) ANY DAMAGE AND LOSS, INCLUDING WITHOUT LIMITATION, DIRECT OR INDIRECT, SPECIAL, CONSEQUENTIAL OR EXEMPLARY, ARISING OUT OF OR RELATING TO THE PRODUCT;
- (2) PERSONAL INJURY OR ANY DAMAGE CAUSED BY INAPPROPRIATE USE OR NEGLIGENT OPERATION OF THE USER;
- (3) UNAUTHORIZED DISASSEMBLE, REPAIR OR MODIFICATION OF THE PRODUCT BY THE USER;
- (4) INCONVENIENCE OR ANY LOSS ARISING WHEN IMAGES ARE NOT DISPLAYED, DUE TO ANY REASON OR CAUSE INCLUDING ANY FAILURE OR PROBLEM OF THE PRODUCT;

- (5) ANY PROBLEM, CONSEQUENTIAL INCONVENIENCE, OR LOSS OR DAMAGE, ARISING OUT OF THE SYSTEM COMBINED BY THE DEVICES OF THIRD PARTY;
- (6) ANY CLAIM OR ACTION FOR DAMAGES, BROUGHT BY ANY PERSON OR ORGANIZATION BEING A PHOTOGENIC SUBJECT, DUE TO VIOLATION OF PRIVACY WITH THE RESULT OF THAT SURVEILLANCE-CAMERA'S PICTURE, INCLUDING SAVED DATA, FOR SOME REASON, BECOMES PUBLIC OR IS USED FOR THE PURPOSE OTHER THAN SURVEILLANCE;
- (7) LOSS OF REGISTERED DATA CAUSED BY ANY FAILURE.

Preface

The network camera WV-NW964 is designed to operate using a PC on a network (10BASE-T/100BASE-TX). By connecting to a network (LAN) or the Internet, images and audio from the camera can be monitored on a PC via a network.

Note:

It is necessary to configure the network settings of the PC and its network environment to monitor images and audio from the camera on the PC. It is also necessary that a web browser is installed on the PC.

Features

Super dynamic 3 (SUPER-D3)

When there is wide variation between the illumination of light and dark areas of the location being monitored, the camera adjusts the lens iris in accordance with the brighter areas. This causes loss of detail in darker areas.

Conversely, adjusting the lens brightness for the darker areas causes the brighter areas to become washed out. SUPER-D 3 digitally combines an image that is set up for a clear view of the brighter areas with an image that is set up for a clear view of the darker areas, creating a final image that preserves overall detail.

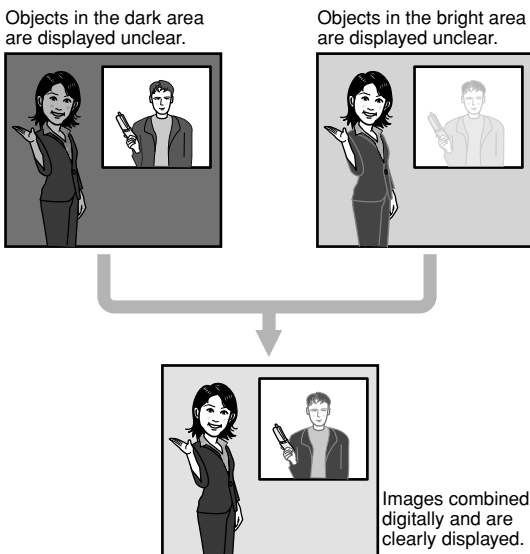

Motion detection function

When a motion is detected, this product will take the following actions.

- Outputs alarm signals
- Transfers images to the FTP server
- Notifies by mail
- Saves images on the mini SD memory card

Note:

The motion detector is not a function dedicated to prevent theft or fire, etc. No warranty is provided for any damage and loss resulting in use of this function.

Progressive output (with motion adaptive interlace/progressive conversion)

The motion adaptive interlace/progressive conversion function compensates aliasing of images (that is specific to interlace scan when shooting motion) and converts images into progressive images. By converting into progressive images, clear images of both motion and stationary objects will be created.

JPEG/MPEG-4 dual encode

MPEG-4 images can be monitored while monitoring JPEG images.

High power lens and high accuracy preset position function

A single camera provides wide area monitoring.

Flip-a-chip function

Normally, the camera will stop when the tilt angle is at 90° (just below). The flip-a-chip function makes possible to tilt the camera from 0° to 180° without stop the tilting motion. This function makes possible to smoothly track and shoot an object passing just under the camera.

Digital flip function

* This illustration is just for instruction, but not the exact form.

- ① Downward
- ② When the camera is tilted to around 135 degree to shoot objects, images displayed upside down will be corrected immediately.
- ③ Upward

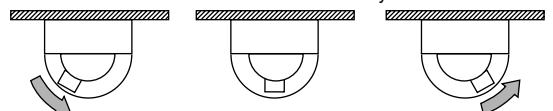

... Keep the joystick of the system controller tilted downward.

Installation on a ceiling or a wall is available

When using an optional mount bracket, pendant-mounting on a ceiling or mounting on a wall is available.

Interactive communication with audio is available

By using the audio output connector and the microphone in connector, receiving audio from the camera on a PC and transmitting audio from the PC to the camera are available.

Mini SD memory card slot

Images can be recorded on an optional mini SD memory card both automatically (when images fail to transmit using the FTP periodic transmission function) and manually. It is possible to play images saved on the mini SD memory card using a web browser or to download images displayed on a web browser.

Note:

Compatible mini SD memory card

Performance with this camera has been checked by using Panasonic's mini SD memory cards (64 MB, 128 MB, 256 MB, 512 MB, 1 GB, and 2 GB).

SD High Capacity (SDHC) card is not compatible with this camera.

About these operating instructions

There are 3 sets of operating instructions for the WV-NW964 as follows.

- Installation guide (book, these operating instructions)
- Network operating instructions (PDF)
- Setup instructions (PDF)

The "Installation Guide" contains descriptions of how to install and connect this camera, and of how to perform the required network settings.

Refer to the "Network operating instructions (PDF)" and the "Setup instructions (PDF)" on the provided CD-ROM for descriptions of how to perform the camera settings and how to operate this camera. Adobe® Reader is required to read the network operating instructions (PDF) and the setup instructions (PDF).

System requirements for a PC

CPU	Pentium® 4 2.4 GHz or faster (A 3.0 GHz CPU or faster CPU is required when using Microsoft® Windows® Vista®.)
Memory	512 MB or more (A minimum of 1 GB memory is required when using Microsoft® Windows® Vista®.)
Network interface	10/100 Mbps Ethernet port x1
Audio interface	Sound card (when using the audio function)
Monitor	Resolution: 1 024 x 768 pixels or more Color: 24-bit True color or better
OS	Microsoft® Windows® XP Home Edition SP2 Microsoft® Windows® XP Professional SP2 Microsoft® Windows Vista® 32-bit*
Web browser	Microsoft® Internet Explorer® 6.0 SP2 Microsoft® Internet Explorer® 7.0 * Microsoft® Internet Explorer® 7.0 is required when using Microsoft® Windows Vista® 32-bit.
Other	CD-ROM drive: It is necessary to read the network operating instructions and use the software on the provided CD-ROM. DirectX® 9.0c or later Adobe® Reader: It is necessary to read the operating instructions on the provided CD-ROM.

Notes:

- When using a PC that does not meet the above requirements, displaying of images may become slow or the web browser may become inoperable.
 - Audio may not be heard if a sound card is not installed on a PC. Audio may be interrupted depending on the network environment.
 - Refer to "Notes on Vista®" (PDF) for further information about system requirements for a PC and precautions when using Microsoft® Windows® Vista®.
-

Trademarks and registered trademarks

- Microsoft, Windows, Windows Vista, Internet Explorer, and DirectX are either registered trademarks or trademarks of Microsoft Corporation in the United States and other countries.
- Intel and Pentium are trademarks or registered trademarks of Intel Corporation or its subsidiaries in the United States and other countries.
- Adobe and Reader are either registered trademarks or trademarks of Adobe Systems Incorporated in the United States and/or other countries.
- Mini SD logo is a trademark.
- Other names of companies and products contained in these operating instructions may be trademarks or registered trademarks of their respective owners.

Network security

As you will use this product connected to a network, your attention is called to the following security risks.

1. Leakage or theft of information through this product
2. Use of this product for illegal operations by persons with malicious intent
3. Interference with or stoppage of this product by persons with malicious intent

It is your responsibility to take precautions such as those described below to protect yourself against the above network security risks.

- Use this product in a network secured by a firewall, etc.
- If this product is connected to a network that includes PCs, make sure that the system is not infected by computer viruses or other malicious entities (using a regularly updated anti-virus program, anti-spyware program, etc.).
- Protect your network against unauthorized access by restricting users to those who log in with an authorized user name and password.
- Apply measures such as user authentication to protect your network against leakage or theft of information, including image data, authentication information (user names and passwords), alarm mail information, FTP server information and DDNS server information.
- Do not install the camera in locations where the camera or the cables can be destroyed or damaged by persons with malicious intent.

CONTENTS

Important safety instructions	3
Limitation of liability	4
Disclaimer of warranty	4
Preface	5
Features	5
About these operating instructions	7
System requirements for a PC	7
Trademarks and registered trademarks	8
Network security	8
Precautions	10
Major operating controls and their functions	12
Precautions for installation	13
Installations/connections	15
Mounting the Camera	15
Installation	17
Connection	19
Connection example	21
Insert/remove a mini SD memory card	22
Insert a mini SD memory card	22
Remove the mini SD memory card	23
Initialize the camera	24
Configure the network settings	25
Install the software	25
Configure the network settings of the camera using the Panasonic IP setting software	25
Troubleshooting	27
Specifications	29
Standard accessories	31

Precautions

When the camera has an internal thermal problem during operation, the indication "OVER HEAT" will be displayed.

In this case, turn off the power of the camera immediately, and then contact your dealer.

What to do if WARM UP-PLEASE WAIT.** appears on the display.

This message indicates that the inside of the camera is cold.

Please wait for a short time until the heating fan warms up the inside of the camera.

The countdown shown as the numbers in "" in quotes is a guideline of the time required. When the value reaches "0" the inside of the camera is warm and the on-screen display disappears. The camera is then reset and operation is normal.

To continue using with stable performance

Parts of this product may deteriorate and it may shorten the lifetime of this product when using in locations subject to high temperatures and high humidity.

(Recommended ambient temperature: 35°C or below)

Do not expose the product to direct heat such as from a heater.

About the position refresh function

Noise may be produced or the preset positions may become inaccurate after a long operation.

Assign the position refresh function to a schedule to correct the camera position periodically, and it is also recommended to clean the slip ring of the camera. Refer to the setup instructions (PDF) for further information.

Try not to give impact to the dome cover.

It may damage the camera or water may intrude into the interior of the camera.

Discoloration on the CCD color filter

When continuously shooting a bright light source such as a spotlight, the color filter of the CCD may have deteriorated and it may cause discoloration. Even when changing the fixed shooting direction after continuously shooting a spotlight for a certain period, the discoloration may remain.

Do not aim the camera at strong light sources.

A light source such as a spot light causes a blooming (light bleeding) or a smear (vertical lines).

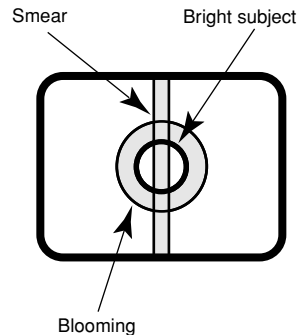

When shooting object right below the camera

When the camera is tilted to just below the camera, a circle locating its center point at the center of the screen may appear. This is caused by the shape of the dome cover. It is not malfunction.

Handle this product with care.

Do not strike or shake, as this may damage the product. It may cause a malfunction.

About the PC monitor

When displaying the same image on the PC monitor for a long time, the PC monitor may be damaged. It is recommended to use a screen-saver.

Consumables

Parts having contacts such as the lens-drive motors, cooling fan motor and slip-rings inside the camera are subject to wear with time. Please ask the nearest service center about replacement and maintenance of such parts.

Cleaning the camera body

Turn the power off when cleaning the camera. Otherwise, it may cause injury. Do not use strong abrasive detergent when cleaning the camera body. Otherwise, it may cause discoloration. When using a chemical cloth for cleaning, read the caution provided with the chemical cloth product.

When the dirt is hard to remove

Use a mild detergent and wipe gently. Then, wipe the detergent completely off with a dry cloth.

Refresh interval

Image refresh interval may become slow depending on the network environment, PC performance, shooting subject, access number, etc.

About the self-diagnosis function

When the camera malfunctions due to exogenous noise, etc. for 30 seconds or more, the camera will automatically reset and will return to normal state. When the camera is reset, initialization will be carried out as when the power of the camera is turned on. When the camera repeatedly resets, exogenous noise level around the camera may be high and that may cause malfunction. Contact your dealer for instructions.

MPEG-4 Visual patent portfolio license

This product is licensed under the MPEG-4 Visual patent portfolio license for the personal and non-commercial use of consumer for (i) encoding video in compliance with the MPEG-4 Visual Standard ("MPEG-4 Video") and/or (ii) decoding MPEG-4 Video that was encoded by a consumer engaged in a personal and non-commercial activity and/or was obtained from a video provider licensed by MPEG LA to provide MPEG-4 Video. No license is granted or shall be implied for any other use. Additional information including that relating to promotional, internal and commercial uses and licensing may be obtained from MPEG LA, LLC. See <http://www.mpegla.com>.

Major operating controls and their functions

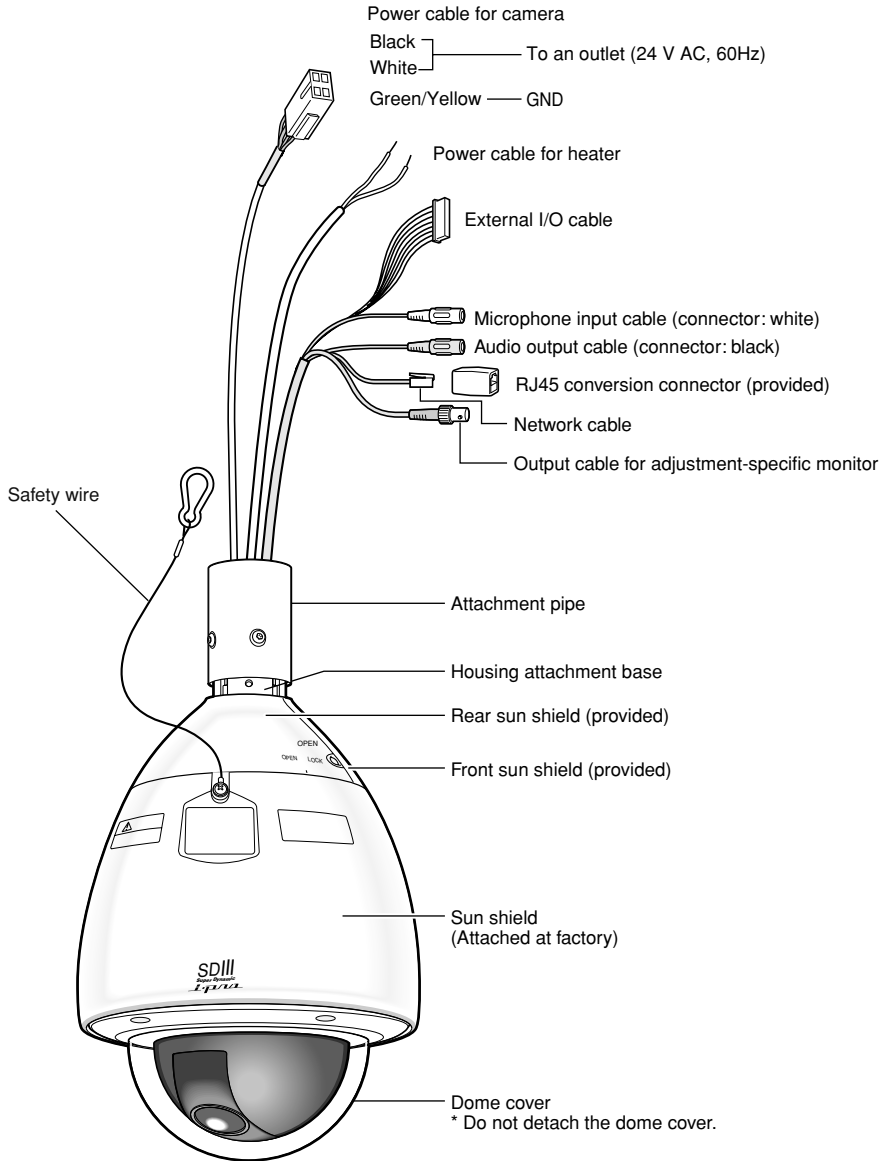

<Upper portion of the sun shield>

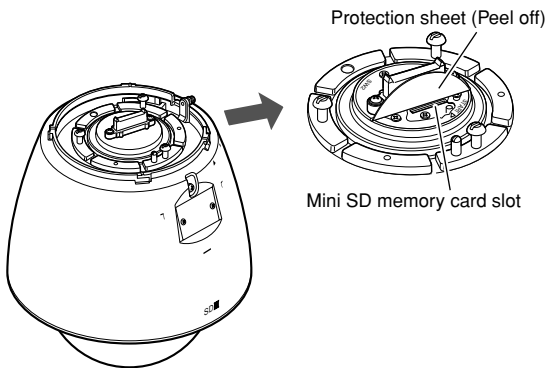

<View from below>

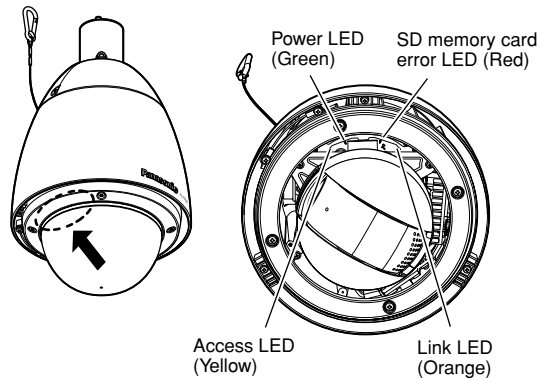

Precautions for installation

All work related to the installation of this product should be made by qualified service personnel or system installers.

Power switch

- This product does not have a power switch. When making the power supply work, create a procedure to turn on/off the power of the camera. The power will be turned on when the power plug is inserted to an outlet. When the power is turned on, the camera will automatically pan/tilt/adjust focus as the startup operation.
When cleaning this product, unplug first.
- A grounding connection must be made before connecting the power cable to the main power supply. When disconnecting the grounding wire, make sure that the power cable of this product is disconnected from the main power supply.

Cautions for installation

Make sure that the installation area is strong enough to hold the camera, such as a concrete ceiling.

- This product is designed to be used as a pendant mount camera. When using after installing it tilted or on desktop, it may not work correctly or its life-time may be shorten.
- This product should be installed with making the camera level. (The dome part should be downward.)
- Be sure to remove this product if it is not in use.

Procure fixing screws locally.

Fixing screws to be used to fix this product are not provided.

Prepare them after considering the total weight, the material and strength of the area where the camera is to be installed.

When tightening fixing screws

Firmly tighten screws/bolts that are suited to fix with the material and strength of the area where the camera is to be installed. After tightening screws/bolts, check with eyes if the camera is fixed firmly.

Avoid installing in the following locations.

- Locations where a chemical agent is used such as a swimming pool
- Locations subject to steam and oil smoke such as a kitchen
- Locations near flammable gas or vapor
- Locations where radiation or x-ray emissions are produced
- Locations where it may be damaged by briny air such as seashores
- Locations where corrosive gas is produced

- Locations where the temperature is not between -40°C - $+50^{\circ}\text{C}$ $\{-40^{\circ}\text{F}$ - $122^{\circ}\text{F}\}$.
- Locations subject to vibrations (This product is not designed for on-vehicle use.)
- Locations subject to condensation as the result of severe changes in temperature (The dome cover may be fogged or condensation may be formed.)

Remove the cover film from the transparent part of the dome cover after the installation is complete.

When the exogenous noise can affect the product performance

When wiring, make sure that the cables of this product are at least 1 meter away from power cables of 100 V or more such as a cable of electric light, or install cable plumbing system with metal pipes to separate cables to prevent noise affect. (Metal pipes should be grounded.)

Radio disturbance

When the camera is used near a TV/radio antenna, or a strong electric field or magnetic field (such as near a motor, a transformer or a electrical power line), images may be distorted and noise may be produced.

Install this product when humidity is low

When installing this product while humidity is high, inside of the dome cover may be fogged.

About the anti-freeze heater

The antifreeze heater is featured for use in a cold region. The antifreeze heater will automatically be turned on when the internal temperature is 10°C or below. However, the antifreeze heater may not work effectively when using this product under severe circumstances such where temperature is at -40°C $\{-40^{\circ}\text{F}\}$. When using this product in a cold region, try not to use this product under severe circumstances where temperature can be lower than -40°C $\{-40^{\circ}\text{F}\}$.

Image quality disturbance

A wiper is not featured in this product. Image may be not displayed or image quality may become low under the following circumstances.

- (1) When raining
When raining and winding, it may be possible that images become unclear due to adhesion of rain-drops to the dome cover.
- (2) When snowing
When snowing and winding, it may be possible that images become unclear due to adhesion of snow to the dome cover.
- (3) When the concentration of dust/smog in the air is relatively high
When the concentration of dust/smog in the air is relatively high, it may be possible that images become unclear due to adhesion of dust/dirt to the dome cover.

Before starting installation

Available system configuration is limited. Start installation after confirming ratings and dimensions. Contact your dealer for further information.

About mini SD memory card

- Before inserting a mini SD memory card into the mini SD memory card slot, turn the power of this product off. Otherwise, it may cause malfunction or damage data recorded on the mini SD memory card. Refer to pages 22 and 23 for descriptions of how to insert/remove a mini SD memory card.
- When using unformatted mini SD memory card, format it using this product. Recorded data on the mini SD memory card will be deleted when formatted. If using an unformatted mini SD memory card or using a mini SD memory card formatted with other device, this product may not work properly or performance deterioration may be caused. Refer to the setup instructions (PDF) for how to format a mini SD memory card.
- It is recommended to use Panasonic's mini SD memory cards (see page 6) since they have tested and confirmed full compatibility with this product. If another mini SD memory card is used, this product may not work properly or performance deterioration may be caused.

Router

When connecting this product to the Internet, use a broadband router with the port forwarding function (NAT, IP masquerade).

Refer to the setup instructions (PDF) for how further information about the port forwarding function.

Heater unit

When the heater unit is installed and use is started in environments of -10°C $\{14^{\circ}\text{F}\}$ or below, normal images may not be obtained immediately after the camera is started up. In this case, wait for the camera to warm up (about 2 hours or more) before turning the power on again.

• 24 V AC Power Supply Connection

Recommended wire gauge sizes for 24 V AC line

Copper wire size (AWG)		#24 (0.22mm ²)	#22 (0.33mm ²)	#20 (0.52mm ²)	#18 (0.83mm ²)
Length of cable (approx.)	(m)	20	30	45	75
	(ft)	65	100	160	260

Accessory Connector Information

Pin no.	Power source
1	24 V AC LIVE
2	24 V AC NEUTRAL
3	Ground
4	Not use

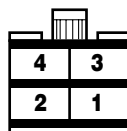

How to Assemble the Cable with the Accessory Connector

Strip back the cable jacket approx. 3 mm {0.1"} and separate the individual conductors.

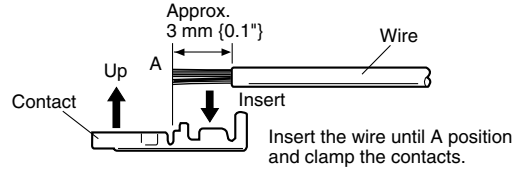

Prepare the individual conductors for clamping. Use MOLEX band tool part number 57027-5000 (for UL-Style Cable UL1015) or 57026-5000 (for UL-Style UL1007) for clamping the contacts.

After clamping the contacts, push them into the proper holes in the accessory connector of this camera until they snap in place.

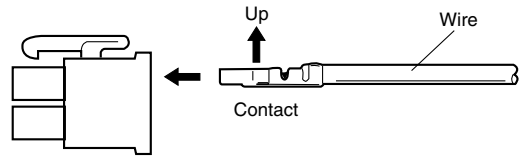

Cautions:

- Shrinking the cable-entry seal is a one-time procedure. Do not shrink the cable-entry seal until ascertaining that the unit is functioning.
- CONNECT THIS TO 24 V AC CLASS 2 POWER SUPPLY ONLY.

Installations/connections

Precautions

- Make sure that the place you are installing the camera is strong enough to support it. If it is not strong enough, then the camera may fall and hurt someone.
- The following steps of installation and connection work should be done by qualified service personnel or system installers and should conform to all local codes.
- Be sure to turn the power off before installation and connection.
- Do not install the camera near the air outlet of an air conditioner.

Mounting the Camera

Ceiling mount

The figure shows an example of the camera mounted on a ceiling with a locally procured bracket. Refer to the instructions included with the bracket for filling gaps and holes with waterproof material.

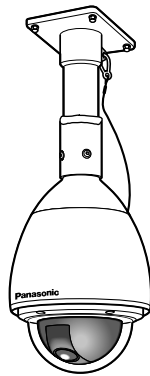

Construction

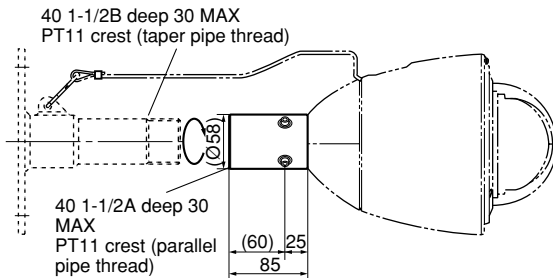

Assemble procedure

1. Preparations

- (1) Procure a ceiling mount bracket.
- (2) To prevent the camera from falling, use a mounting a bracket to which a safety wire can be attached.
- (3) Installation Surface

Caution: Consult an expert on the load bearing capacity of the installation surface and structure. If the surface is not strong enough, the camera may fall down. Refer to the product specifications for weights.

Prepare appropriate hardware (e.g. wall nuts, anchor bolts, etc.) for fixing on the installation surface.

2. Disassembling the Camera

- (1) Remove the upper base from the camera by loosening 3 screws. The screws that are removed need to be used during reassembly. Be careful to not lose them. Turn the upper base and separate it.
 - * Special screw (mounting screw): Use a hexagon wrench for the hexagon screw (M6).

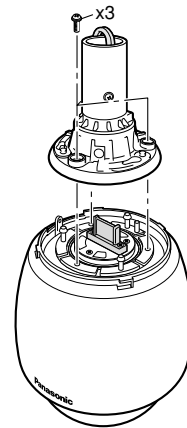

- (2) Remove the attachment pipe from the upper base by loosening 4 screws.
 - * Special screw (mounting screw): Use a hexagon wrench for the hexagon screw (M6).

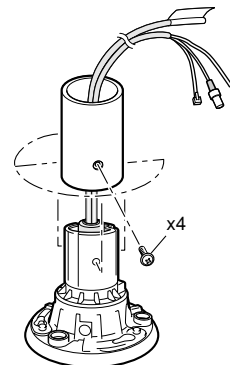

3. Mounting the Bracket

- (1) Fix the bracket to the installation surface using appropriate bolts, nuts or the like (not supplied). Make sure that everything is tightened securely.

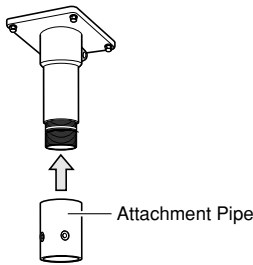

- (2) Fix the attachment pipe to the bracket.
- (3) Thread cables through the bracket. Connect cables, referring to CONNECTIONS.
Warning: Seal the cables with plastic or rubber tape to prevent it from being exposed.

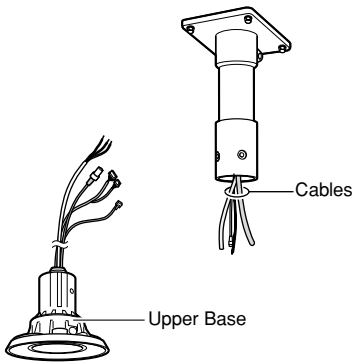

- (4) Fix the upper base to the attachment pipe.
 - Fasten 4 screws (the screws that were removed in step (2) of "2. Disassembling the Camera") making sure that "REAR" engraved on the upper base faces the wall.
Recommended torque: Approximately 5.0 N/m {51 kgf cm}
 - Fill the gap between the bracket and attachment pipe with waterproof material such as silicon clay. See instructions of the bracket for details.

Warning: Carefully apply the sealing so that water or moisture cannot get inside. If water gets inside the camera it could cause a shock or fire. Also, if moisture gets inside the camera it could cause the dome to become foggy.

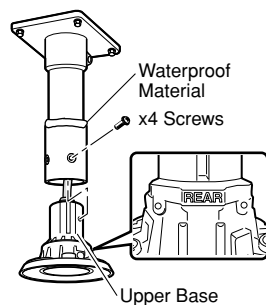

4. Mounting the camera

- (1) Aim the "START" arrow at the bent portion of the leaf spring.

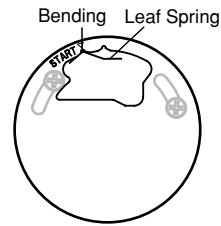

- (2) Be sure to hook the fall prevention wire into the bracket.

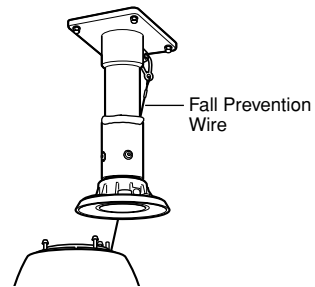

- (3) Fix the camera to the upper base.
 - Move the camera up so that its guide pins fit into the guide holes of the upper base.
 - Turn the camera counter-clockwise to the end, viewed from the bottom.
 - Fasten 3 screws (the screws that were removed in step (1) of "2. Disassembling the Camera").

Caution: Tighten the three (3) mounting screws for the upper base.
Recommended torque: Approximately 5.0 N/m {51 kgf cm}
Poorly tightened screws may result in water leaking into the camera or possible fire.

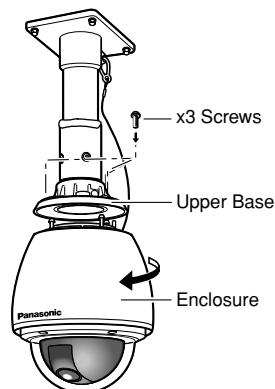

Installation

Before starting installation/connection, make sure that the power cable is not connected to an outlet. Read the "Precautions for installation" section before starting installation/connection. (☞ page 13)

Step 1

Install the mount bracket.

- Refer to "Mounting the Camera" (page 15).

Step 2

Insert a mini SD memory card into the mini SD memory card slot.

- Refer to page 21 for how to insert a mini SD memory card.

Step 3

Connect the cables.

- Refer to page 18 for how to connect the cables.

Step 4

Mount the camera onto the mount bracket.

1. Mount the camera onto the housing attachment base and fix them with the screws at 3 places

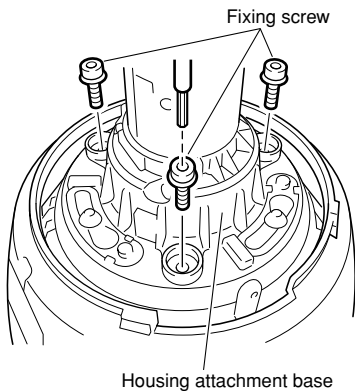

2. Attach the provided watertight caps onto the screw heads.

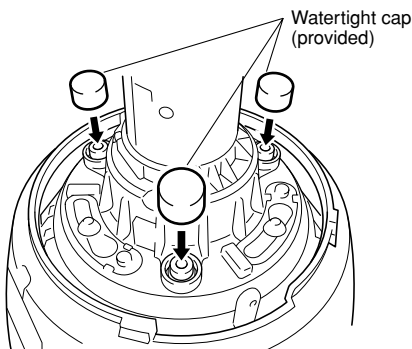

Step 5

Attach the provided front/rear sun shields to the camera.

1. Hold the concave portions of the front/rear sun shields with your fingers and disassemble it by releasing the stoppers. The front/rear sun shields are connected by the wire to prevent losing one of them.

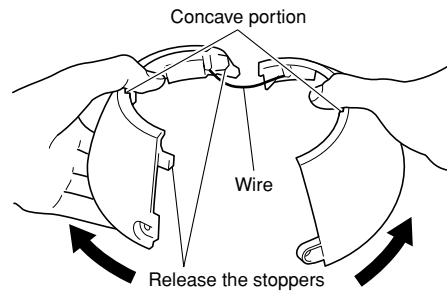

2. Position the front/rear sun shields to tuck down the housing attachment base.

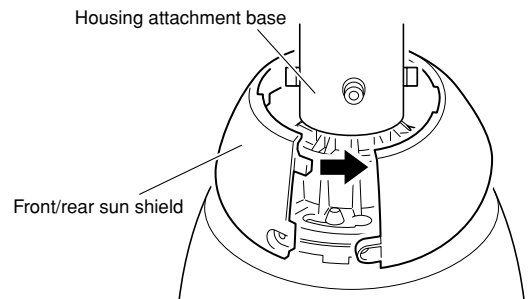

3. Attach the front/rear sun shields together. Fit up the stopper on the wired side first, and then fit up the stopper on the other side.

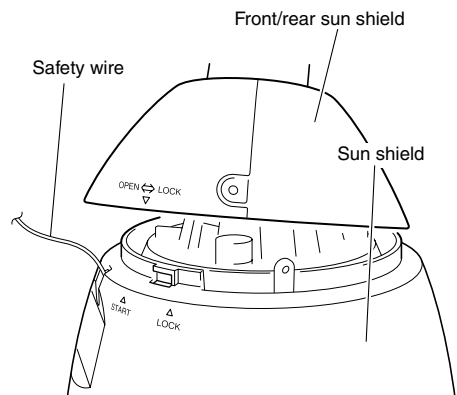

Important:

- The stopper of the front/rear sun shields should be fitted up to attach them together before attaching to the sun shield.
 - Don't put the safety wire inside the sun shield.
 - The safety wire is designed to support weight of the camera. Do not load more than the weight of the camera.
-

Step 6

Fix the front/rear sun shields to the sun shield.

- Put the attached front/rear sun shields and the sun shield together while matching the mark ∇ and the mark Δ (START) on the sun shield, and then rotate the front/rear sun shield clockwise until the mark ∇ reaches the mark Δ (LOCK) on the sun shield.

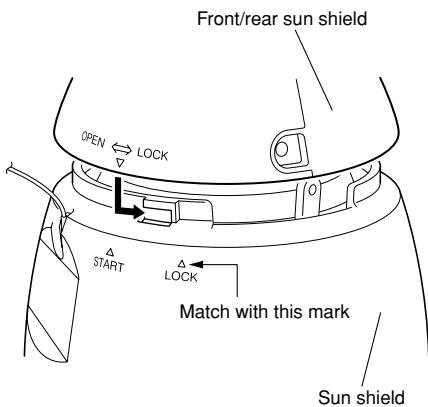
**Step 7**

Fix the front/rear/sun shields with the sun shield using the fixing screws for the front/rear sun shield.

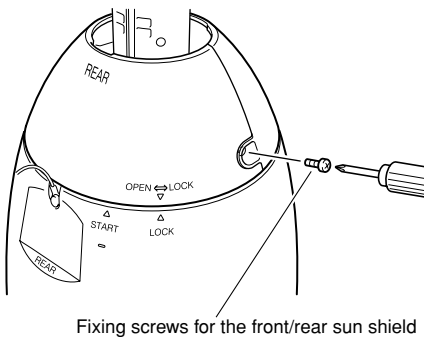

Important:

- When the power is turned on, the camera will start rotating and the position will automatically be initialized.
 - Do not touch the camera in the process of the initialization. Otherwise, it may fail to initialize and may cause malfunction.
 - When the camera has been inadvertently touched and moved after the initialization is complete, the preset positions may be inaccurate. In this case, use the position refresh function or restart the camera to correct the preset positions. Refer to the setup instructions (PDF) for further information.
 - To detach the front/rear sun shield, do steps 5 - 7 reversely.
-

Connection

Caution:

Before starting connection, make sure that the circuit breaker is switched off. Failure to do so could result in fire, injury, electric shock or property destruction.

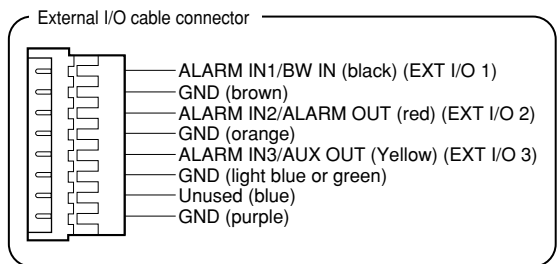
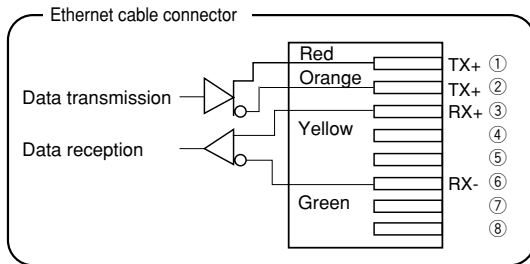
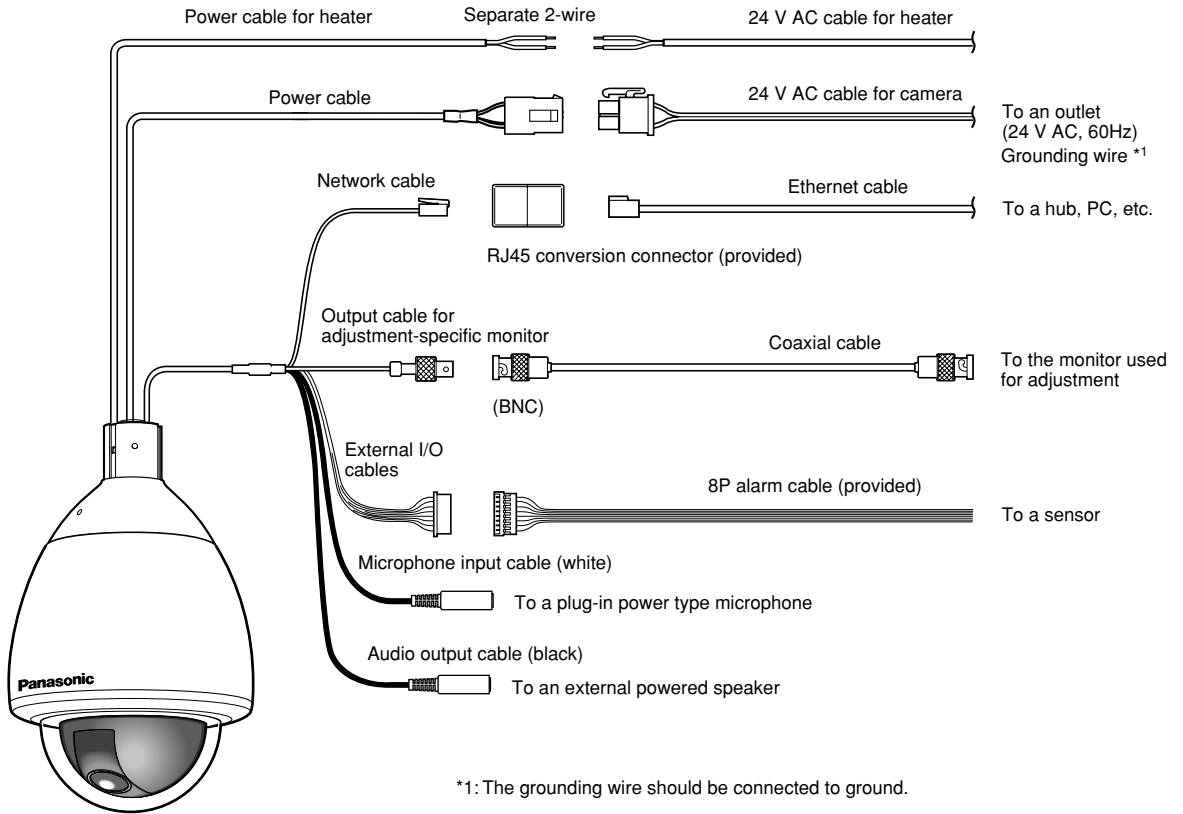

• Network cable

Connect with an Ethernet cable (category 5 or better).

Important:

Maximum length of an Ethernet cable that can be connected is 100 m.

• Output cable for adjustment-specific monitor

Connect with a coaxial cable (BNC) (only when checking video signal output).

The monitor out connector is provided only for checking the adjustment of the angular field of view on the video monitor when installing the camera or when servicing.

• External I/O cables

Important:

- Input and output of EXT I/O terminal 2 and 3 can be switched by configuring the setting. The default of EXT I/O terminal 2 is "ALARM IN 2" and of EXT I/O terminal 3 is "ALARM IN 3". It is possible to determine whether or not to receive input from EXT I/O terminal 2 and 3 (ALARM IN2, 3) by selecting "OFF", "Alarm input", "Alarm output" or "AUX output" for "Terminal alarm 2" or "Terminal alarm 3" on the [Alarm] tab on the "Alarm setup" page. Refer to the setup instructions (PDF) for further information.
 - When selecting "Alarm output" for EXT I/O terminals, avoid signal collision with external signals.
-

<Ratings>

- ALARM IN1/BW IN, ALARM IN2, ALARM IN3

Input specification: Non-voltage make contact
(DC 4 - 5 V internal pull-up)

OFF: Open or DC 4 - 5 V

ON: Make contact with GND (drive current: 1 mA or more)

- ALARM OUT, AUX OUT

Output specification: Open collector output
(Maximum applied voltage: DC 20 V)

OPEN: DC 4 - 5 V by internal pull-up

CLOSE: Output voltage: DC 1 V or less (maximum drive current: 50 mA)

• Microphone in connector

Connect the mini plug (ø3.5 mm) of a plug-in power type microphone (sold separately).

Supply voltage: 2.5 V ±0.5 V

Input impedance: 3 kΩ ±10 %

Recommended sensitivity of microphone:

-48 dB ±3 dB (0 dB=1 V/Pa, 1 kHz)

Recommended cable length: Less than 1 m

Important:

Connect/disconnect the audio/video cables after turning off the power of the camera and the amplifier. Otherwise, loud noise may be heard from the speaker.

• Audio output connector

Connect a monaural mini plug (ø3.5 mm). Use a powered external speaker.

Recommended cable length: Less than 10 m

Note:

Make sure that the stereo mini plug is connected to this connector. When a monaural mini plug is connected, audio may not be heard.

When connecting a monaural powered speaker, use an optional conversion cable (mono-stereo).

Connection example

When connecting with a PC directly

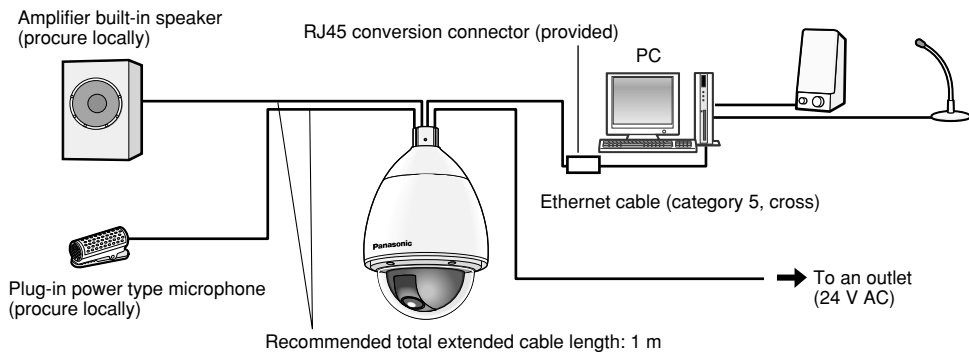

<Required cables>

Ethernet cable (category 5, cross)

When connecting to a network (hub)

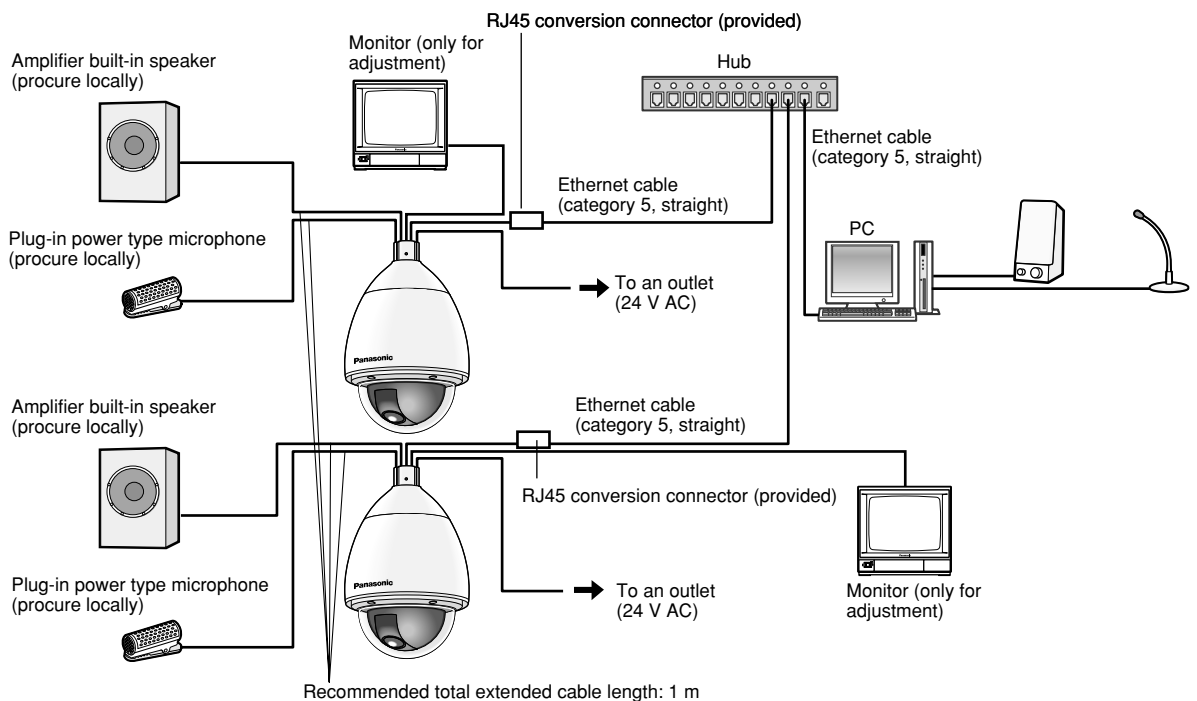

<Required cables>

Ethernet cable (category 5, straight)

Important:

- The monitor out connector is provided only for checking the adjustment of the angular field of view on the video monitor when installing the camera or when servicing. It is not provided for recording/ monitoring use.
- Depending on the monitor, some characters (camera title, preset ID, etc.) may not be displayed on the screen.
- Use a switching hub or a router which is compliant with 10BASE-T/100BASE-TX.
- Power supply is required for each network camera.

Insert/remove a mini SD memory card

Important:

Before inserting the mini SD memory card, turn off the power of the camera first.

Insert a mini SD memory card

Step 1

Position the camera in order to see the upper portion of the sun shield.

- When attaching to the housing attachment base, detach the sun shield from the housing attachment base. Refer to the operating instructions of the housing attachment base for how to detach the sun shield.

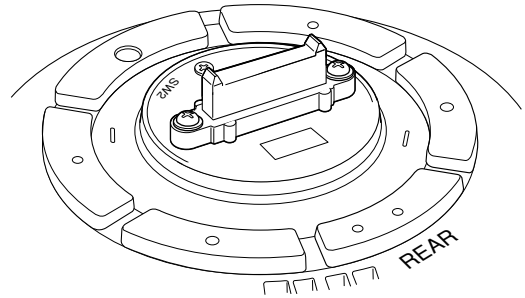

Step 2

Flip the protection sheet as shown in the illustration.

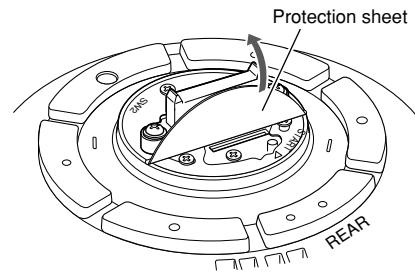

Step 3

Insert the mini SD memory card into the mini SD card memory slot.

- Put the protection sheet back into place as it was after inserting the mini SD memory card.

Important:

The mini SD memory card should be inserted with the insertion direction as printed on the protection sheet. If it is inserted with wrong insertion direction with force, it may cause malfunction.

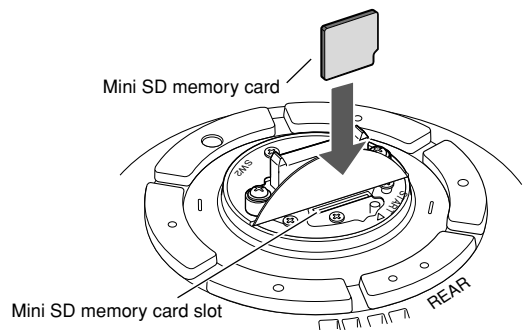

Step 4

Attach the sun shield to the housing attachment base.

Refer to the operating instructions of the housing attachment base for how to attach the sun shield.

Step 5

Select "Use" for "SD memory card" on the [SD memory card] tab of "Basic Setup" on the setup menu. (☞ Setup instructions (PDF))

Step 6

Select "Format" for "SD memory card" on the [SD memory card] tab of "Basic Setup" on the setup menu. (☞ Setup instructions (PDF))

Remove the mini SD memory card

Important:

Before removing the mini SD memory card, select "Not use" for "SD memory card" on the [SD memory card] tab of "Basic Setup" on the setup menu first. After configuring the setting above, turn off the power of the camera and then remove the mini SD memory card. (☞ Setup instructions (PDF))

Step 1

Detach the sunshield from the housing attachment base, and then position the camera in order to see the upper portion of the sun shield.

- Refer to the operating instructions of the housing attachment base for how to detach the sun shield.

Step 2

Flip the protection sheet by following step 2 of "Insert a mini SD memory card" section.

Step 3

Release the locked mini SD memory card by pushing the card and then pull the mini SD memory card from the slot.

- Put the protection sheet back into place as it was after inserting the mini SD memory card.

Initialize the camera

Use the DIP switch to initialize the camera.

Important:

The settings including the network settings will be initialized. Note that the preset position settings will not be initialized.

Step 1

Detach the housing attachment base, and then flip the protection sheet on the upper portion of the sun shield.

- Refer to the operating instructions of the housing attachment base for how to detach the sun shield.

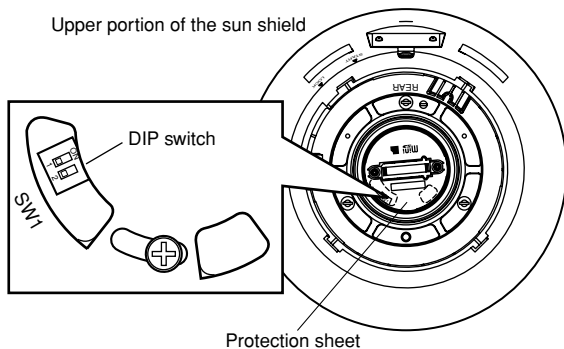

Step 2

Set DIP switch 1 to "ON".

- The default positions of each DIP switch are OFF.

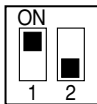

Step 3

Attach the housing attachment base.

Step 4

Turn on the power of the camera. (☞ page 13)

- Look inside the camera from the dome cover side and confirm that the power LED (green) and the SD memory card error LED (red) are blinking. When they are blinking, the initialization is completed.
- * When looking inside the camera from the part indicated by the arrow mark in the illustration, the LEDs can be found as shown in the illustration "View from below".

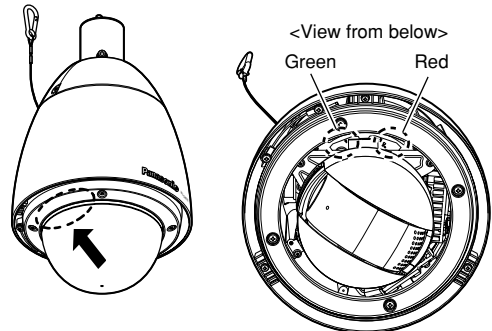

Step 5

Turn off the power of the camera, and then detach the housing attachment base.

Step 6

Set DIP switch 1 to "OFF".

- Put the protection sheet back into place as it was after setting DIP switch 1 to "OFF".



Important:

When DIP switch 1 is in the "ON" position, the camera will not be operated in normal state. Make sure that DIP switch 1 is in the "OFF" position.

Step 7

Attach the housing attachment base.

Step 8

Turn on the power of the camera. (☞ page 13)

- When the power of the camera is turned on, the camera will be operated in normal state.

Configure the network settings

Install the software

Before installing the software, read the readme file on the provided CD-ROM first.

Software included on the provided CD-ROM

- Panasonic IP Setup Software
Configure the network settings of the camera. Refer to the following for further information.
- Viewer Software "Network Camera View3"
It is necessary to install the viewer software "Network Camera Viewer3" to display images on a PC. Install the viewer software by following the displayed instructions after double-clicking the "nwc3setup.exe" icon on the provided CD-ROM or install from the camera directly (☞ Setup instructions (PDF)).

Configure the network settings of the camera using the Panasonic IP setting software

It is possible to perform the network settings of the camera using the IP setup software on the provided CD-ROM. When using multiple cameras, it is necessary to configure the network settings of each camera independently. If the Panasonic IP setting software does not work, perform the network settings of the camera and the PC individually on the "Network setup" page of the setup menu. Refer to the setup instructions (PDF) for further information.

Important:

- The "Windows Security Alert" window may be displayed when starting the IP setup software. In this case, click the "Unblock" button on the displayed "Windows Security Alert" window.
 - For the security enhancement, the MAC address/IP address of the camera to be configured will not be displayed when around 20 minutes have passed after turning on the power of the camera. However, the MAC address/IP address of the camera will be displayed even after around 20 minutes have passed when the values of all the following setup items are still the default values; "IP address", "Default gateway", "Net mask", "HTTP port", "DHCP", "User name", "Password".
 - The Panasonic IP setting software is inoperable in other subnets via the same router.
-

Step 1

Start the Panasonic IP setting software.

Step 2

Click the [IP setting] button after selecting the MAC address/IP address of the camera to be configured.

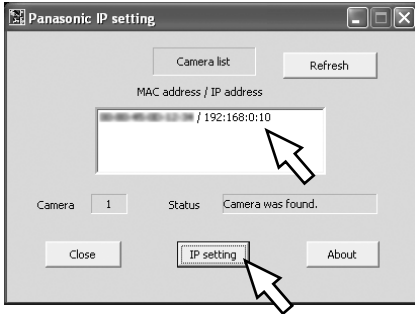

Note:

When using a DHCP server, the IP address assigned to the camera can be displayed by clicking the [Refresh] button of the IP setting software.

Step 3

Complete each network setup item and click the [Apply] button.

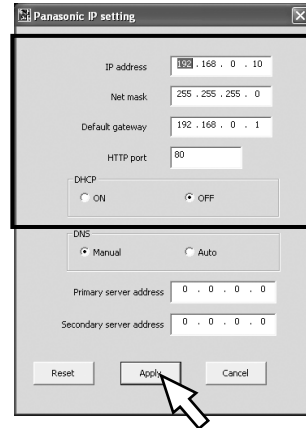

Note:

When using a DHCP server, it is possible to set "DNS" to "AUTO".

Important:

- It may take around 30 seconds to completely upload the settings of the camera after clicking the [Apply] button. The settings may be invalidated when the power supply is cut or when the LAN cable is disconnected before completing the upload. In this case, perform the settings again.
- When using a firewall (including software), allow access to all UDP ports.

Troubleshooting

Before asking for repairs, check the symptoms on the following table.

Contact your dealer if a problem cannot be solved even after checking and trying the solution or if the problem is not described below.

Symptom	Cause/solution	Reference pages
The power cannot be turned on.	<ul style="list-style-type: none"> Is the power cable connected firmly to an outlet that meets the required specifications? Check if it is connected correctly and firmly. 	19
	<ul style="list-style-type: none"> Is the housing attachment base attached to the camera firmly? Check if it is attached correctly and firmly. 	17
The camera does not move to the preset positions accurately.	<ul style="list-style-type: none"> Execute the refresh position function to correct the camera position when the camera does not move to the set position precisely. It is also possible to correct the camera position periodically by assigning the position refresh function to a schedule. In some situations, reconfigure the preset positions. 	Setup instructions (PDF)
When the camera is panning/tilting, the camera stops panning/tilting and mechanical noise comes from the camera.	<ul style="list-style-type: none"> When the camera position is moved after turning on the power of the camera, the camera may stop in the process of panning/tilting and mechanical noise will come out from the camera. Execute the refresh position function from the [Initialization] tab of the "Maintenance" page. 	Setup instructions (PDF)
The camera starts panning unpredictably.	<ul style="list-style-type: none"> This may be caused by noise. Check the exogenous noise level around the camera. 	13
Audio input contains noise.	<ul style="list-style-type: none"> Check the following. <ul style="list-style-type: none"> Grounding of the camera, a switching hub or a peripheral device is not done. The camera is used near an electrical power line. The camera is used near a device which produces strong magnetic field or radio waves (such as near a TV/radio antenna, a motor of an air conditioning system, a transformer, etc.) <p>When audio input still contains noise even after checking the above possibilities, use a powered microphone or connect Audio output with low output impedance.</p>	13

Inspect the power cable, power plug and connectors periodically.

Symptom	Cause/solution
The power cable insulation is damaged.	<ul style="list-style-type: none">• The power cable, plug and connectors are worn out. This may result in electric shock or a fire. Unplug the power plug from the AC outlet immediately, and refer to qualified service personnel.
The power cable, plug and connectors get hot during use.	
The power cable gets hot when bent or stretched.	

Specifications

General

Power source	24 V AC, 60 Hz
Power consumption	23 W (for camera), 62 W (for heater)
Ambient temperature	-40 °C - +50 °C {-40 °F - 122 °F} (Recommended temperature: 35 °C {95 °F} or below)*1
Ambient humidity	90 % or less (non-condensing)
Monitor output (for adjustment)	VBS: 1.0 V [P-P]/75 Ω (NTSC), composite (BNC)
External I/O terminals	ALARM IN 1/BW IN, ALARM IN 2/ALARM OUT, ALARM IN 3/AUX OUT (x1 each)
Microphone input	ø3.5 mm mini jack (Applicable microphone: Plug-in power type) Supply voltage: 2.5 V ±0.5 V, Input impedance: 3 kΩ ±10 %
Audio output	ø3.5 mm stereo mini jack (Monaural output, Line level)
Waterproofing ability	Conforms to IP66's Weather Resistant Standards (IEC60529/JIS C 0920)
Heater	Operates when the internal temperature is 10 °C or below
Dimensions	ø239 mm x 360.5 mm (H), diameter of the dome: 160 mm
Weight	Camera: Approx. 4.7 kg

Camera

Image sensor	1/4 inch interline transfer CCD
Effective pixels	768 (H) x 494 (V)
Scanning area	3.59 mm (H) x 2.70 mm (V)
Scanning system	2:1 interlace scan (with motion adaptive interlace/progressive conversion function for network output)
Minimum illumination	Color: 0.5 lx {0.05 footcandle}, black and white: 0.04 lx {0.004 footcandle} (Sensitivity up: OFF, AGC: HIGH, F1.4 WIDE)
Dynamic range	52 dB typ. (Super dynamic 3: ON, Shutter speed: OFF)
Gain	ON (LOW)/ON (MID)/ON (HIGH)/OFF
Shutter speed	OFF (1/60), AUTO, 1/100
Sensitivity up	Up to 32x
Black & white mode	ON/OFF/AUTO (HIGH)/AUTO (LOW)
White balance	ATW1/ATW2/AWC
Digital noise reduction (DNR)	LOW/HIGH
Electronic zoom	Up to 10x
Camera title	Up to 16 characters (alphanumeric characters, marks) ON/OFF
VMD alarm	ON/OFF, 4 areas available per preset position
Image hold	ON/OFF
Image stabilization	ON/OFF
Privacy zone	ON/OFF (up to 8 zones available)

Lens

Zoom ratio	30x
Focal length	3.8 mm - 114 mm
Maximum aperture ratio	1 : 1.4 (WIDE) - 3.7 (TELE)
Macro	1.5 m
Aperture range	F1.4 - 22, Close
Angle of view	Horizontal: 1.9 ° (TELE) - 52 ° (WIDE) Vertical: 1.4 ° (TELE) - 40 ° (WIDE)

Panning/tilting platform

Panning range	360 ° Endless panning
Panning speed	Manual: Approx. 0.065 °/s - 120 °/s, preset: up to approx. 400 °/s
Tilting range	-5 ° - 185 ° (horizontal - vertical - horizontal) (Depends on the TILT ANGLE setting) Selectable tilting angle: 0 °/-1 °/-2 °/-3 °/-4 °/-5 °
Tilting speed	Manual: Approx. 0.065 °/s - 120 °/s, preset: up to approx. 400 °/s
Number of the preset positions	256
Auto mode	OFF/preset sequence/auto pan/auto track/patrol
Self return	10 s/20 s/30 s/1 m/2 m/3 m/5 m/10 m/20 m/30 m/60 m
Map shot	360 ° map shot/preset map shot

Network

Network	10BASE-T/100BASE-TX, RJ45 connector
Resolution	VGA (640 x 480)/QVGA (320 x 240)
Image compression method	
MPEG-4	Image mode: Motion priority/Standard/Quality priority Transmission type: UNICAST/MULTICAST bitrate: (constant bit rate) 64 kbps/128 kbps/256 kbps/512 kbps/1 024 kbps/ 2 048 kbps/4 096 kbps (frame rate priority) 4 096 kbps/Unlimited
JPEG	Image quality: 0 SUPER FINE/1 FINE/2/3/4/5 NORMAL/6/7/8/9 LOW (10 steps: 0-9) Transmission type: PULL/PUSH
Refresh interval	0.1 fps - 30 fps (Frame rate of JPEG display will be limited when displaying JPEG and MPEG-4 simultaneously.)
Audio compression method	G.726 (ADPCM) 32 kbps/16 kbps
Bandwidth Control	Unlimited/64 kbps/128 kbps/256 kbps/512 kbps/1 024 kbps/2 048 kbps/ 4 096 kbps
Protocol	TCP/IP, UDP/IP, HTTP, RTP, FTP, SMTP, DHCP, DNS, DDNS, NTP, SNMP
OS	Microsoft® Windows® XP Home Edition SP2, Microsoft® Windows® XP Professional SP2, Microsoft® Windows® Vista®*1 32-bit*2
Web browser	Microsoft® Internet Explorer® 6.0 SP2, Microsoft® Internet Explorer® 7.0 *2 Microsoft® Internet Explorer® 7.0 is required when using Microsoft® Windows Vista® 32-bit.
Maximum concurrent access number	8 (Depends on network conditions)
FTP client	Alarm image transmission, FTP periodic transmission
Multi-screen	Images from 16 cameras (4 cameras x 4 groups) can be displayed simultaneously.
Mini SD memory card (option)	Manufactured by Panasonic (Performance with this camera has been checked.) Capacity: 64 MB, 128 MB, 256 MB, 512 MB, 1 GB, 2 GB * SD High Capacity (SDHC) card is not compatible with this camera.

*1 Refer to "Notes on Vista®" for further information about system requirements for a PC and precautions when using Microsoft® Windows® Vista®.

Standard accessories

Installation guide (this book)	1 pc.
Warranty	1 pc.
CD-ROM*	1 pc.
Code label	1 pc.
RJ45 conversion connector	1 pc.

* The CD-ROM contains the operating instructions (PDFs) and the software.

The following are for installation.

Front/rear sun shield	1 pair
Fixing screws for the front/rear sun shield	2 pcs. (incl. a spare screw)
Watertight cap	3 pc.
Connector for 24 V AC	1 pc.
8P alarm cable	1 pc.
(The provided 4P alarm cable is not to be used with this product.)	

Panasonic System Solutions Company,
Unit Company of Panasonic Corporation of North America
www.panasonic.com/business/
For customer support, call 1.800.528.6747
Three Panasonic Way 2H-2, Secaucus, New Jersey 07094

Panasonic Canada Inc.
5770 Ambler Drive, Mississauga,
Ontario, L4W 2T3 Canada (905)624-5010
<http://www.panasonic.ca>

Panasonic Sales Company
Division of Panasonic Puerto Rico Inc.
San Gabriel Industrial Park 65th Infantry Ave. KM. 9.5 Carolina
P.R. 00985(809)750-4300