

Installation Guide

Included Installation Instructions

Network Camera

Model No. **WV-SW175/WV-SW172**



For U.S. and Canada:
Panasonic System Communications Company of North America, Unit of Panasonic Corporation of North America
 www.panasonic.com/business/ For customer support, call 1.800.528.6747 Two Riverfront Plaza, Newark, NJ 07102-5490

For Europe and other countries:
Panasonic Corporation
 http://www.panasonic.com

Panasonic Corporation
 Osaka, Japan

Authorized Representative in EU:
 Panasonic Testing Centre
 Panasonic Marketing Europe GmbH
 Winsbergweg 15, 22525 Hamburg, Germany
 www.panasonic.ca

© Panasonic Corporation 2017 av51013-1047 PGQX1451YA Printed in China

Before attempting to connect or operate this product, please read these instructions carefully and save this manual for future use.

The model number is abbreviated in some descriptions in this manual. This document is the Installation Guide for use in other countries except Japan.

WARNING:

- To prevent injury, this apparatus must be securely attached to the floor/wall/ceiling in accordance with the installation instructions.
- The installation shall be carried out in accordance with all applicable installation rules.
- The connections should comply with local electrical code.

For U.S.A
 This product contains a Cr Coin Cell Lithium Battery which contains Perchlorate Material - special handling may apply. See www.dtc.ca.gov/hazardouswaste/perchlorate/

For Canada
 CAN ICES-3(A)/NMB-3(A)

For U.S.A
 NOTE: This equipment has been tested and found to comply with the limits for a Class A digital device, pursuant to Part 15 of the FCC Rules. These limits are designed to provide reasonable protection against harmful interference when the equipment is operated in a commercial environment. This equipment generates, uses, and can radiate radio frequency energy and, if not installed and used in accordance with the instruction manual, may cause harmful interference to radio communications. Operation of this equipment in a residential area is likely to cause harmful interference in which case the user will be required to correct the interference at his own expense.

FCC Caution: To assure continued compliance, (example - use only shielded interface cables when connecting to computer or peripheral devices). Any changes or modifications not expressly approved by the party responsible for compliance could void the user's authority to operate this equipment.

For U.S.A
 The model number and serial number of this product may be found on the surface of the unit. You should note the model number and serial number of this unit in the space provided and retain this book as a permanent record of your purchase to aid identification in the event of theft.

Model No. _____
 Serial No. _____

For Europe
 We declare under our sole responsibility that the product to which this declaration relates is in conformity with the standard or other normative document following the provisions of Directive 2004/108/EC.
 Wir erklären in alleiniger Verantwortung, daß das Produkt, auf das sich diese Erklärung bezieht, mit der folgenden Norm oder normativen Dokument übereinstimmt. Gemäß den Bestimmungen der Richtlinie 2004/108/EC.

Precautions for use

This product has no power switch.
 When turning off the power, disconnect the power supply from the 12 V DC power supply or the PoE device. (When using both the 12 V DC power supply and the PoE device for power supply, disconnect both the connections.)

To keep on using with stable performance
 Do not use this camera in hot and humid conditions for a long time. Failure to observe this causes component degradation resulting in life shortening of this product.
 Do not expose this camera to direct heat sources such as a heater.

Do not touch the lens cover with your bare hands.
 A dirty lens cover causes deterioration of picture quality.

Handle this camera with care.
 Do not drop this camera, nor apply shock or vibration to this camera. Failure to observe this may cause trouble.

About the PC monitor
 Displaying the same image on a monitor for a long time may damage the monitor. It is recommended to use a screen-saver.

When an error is detected, this product will restart automatically.
 This product will be inoperable for around 2 minutes after the restart just as when the power is turned on.

Product disposal/transfer
 Data saved on this product or a storage device used with this product may lead to personal information leakage. When it is necessary to dispose or give this product to someone, even when for repair, make sure that there is no data on this product.

Cleaning this product body
 Be sure to turn off the power before cleaning. Failure to observe this may cause injury. Do not use strong abrasive detergent when cleaning this product. Otherwise, it may cause discoloration. When the dirt is hard to remove, use a damp cloth and wipe the dirty areas. Then, wipe with a dry cloth to remove any moisture.

Transmission interval
 Image transmission interval may become slow depending on the network environment, PC performance, shooting subject, access number, etc.

About SD memory card

- When using an unformatted SD memory card, format it using this camera. Recorded data on the SD memory card will be deleted when formatted. If an unformatted SD memory card or an SD memory card formatted with other devices is used, this product may not work properly or performance deterioration may be caused. Refer to the Operating Instructions (included in the CD-ROM) for how to format a SD memory card.
- When some SD memory cards are used with this product, the product may not work properly or performance deterioration may be caused. Use the SD memory cards recommended.

Code label
 The code labels (accessory) are required at inquiry for trouble. Use caution not to lose these labels. It is recommended to paste one of the labels onto the CD-ROM case.

About the MOS image sensor

- When continuously shooting a bright light source such as a spotlight, the color filter of the MOS image sensor may have deteriorated and it may cause discoloration. Even when changing the fixed shooting direction after continuously shooting a spotlight for a certain period, the discoloration may remain.
- When shooting fast-moving subjects or performing panning/tilting operations, objects crossing the shooting area may look to be bending askew.

AVC Patent Portfolio License
 THIS PRODUCT IS LICENSED UNDER THE AVC PATENT PORTFOLIO LICENSE FOR THE PERSONAL USE OF A CONSUMER OR OTHER USES IN WHICH IT DOES NOT RECEIVE REMUNERATION TO
 (i) ENCODE VIDEO IN COMPLIANCE WITH THE AVC STANDARD ("AVC VIDEO") AND/OR
 (ii) DECODE AVC VIDEO THAT WAS ENCODED BY A CONSUMER ENGAGED IN A PERSONAL ACTIVITY AND/OR WAS OBTAINED FROM A VIDEO PROVIDER LICENSED TO PROVIDE AVC VIDEO. NO LICENSE IS GRANTED OR SHALL BE IMPLIED FOR ANY OTHER USE. ADDITIONAL INFORMATION MAY BE OBTAINED FROM MPEG LA, L.L.C.
 SEE HTTP://WWW.MPEGLA.COM

Flickering
 Due to the influence of lighting, flickering may sometimes happen. In this case, select "Indoor scene" for "Light control mode". Select "Indoor scene(50Hz)" or "Indoor scene(60Hz)" in accordance with the power supply frequency in your locality. Refer to the Operating Instructions (included in the CD-ROM) for further information about the setting.

Under extremely strong lighting, flickering may happen even when "Indoor scene" is selected for "Light control mode". When the brightness (luminance) level on the screen is set to a relatively low level with the [Brightness] buttons, flickering may frequently happen. In such cases, either of the following can reduce flickering.

- Moderate the illumination intensities of objects by changing the camera direction.
- Set the brightness (luminance) level on the screen to a brighter level with the [Brightness] buttons.

White-out on images caused by the effect of light control mode
 When "Indoor scene" is selected for "Light control mode", the tone of the brighter parts on the screen may be deteriorated than the case when "ELC" is selected.

Color blurring on detailed drawing patterns
 When there are detailed drawing patterns on images, color blurring may happen over these parts.

Consumable parts
 The following are consumables: Replace them in accordance with their lives. Their lives vary depending on use environment and conditions. Lifetime is just an indication when using the camera at +20 °C (68 °F).

- Panning motor, tilting motor, flat cable for tilting: Approx. 3.7 million operations.

Lens and pan/tilt head
 As a lens and pan/tilt head is not performed for a long period of time, the grease coating inside these parts may become sticky. That may obstruct the parts from moving. To prevent this, move the lens or pan/tilt head periodically.

Nous déclarons sous notre propre responsabilité que le produit auquel se réfère la présente déclaration est conforme à la norme spécifiée ou à tout autre document normatif conformément aux dispositions de la directive 2004/108/CE.
 Nosotroś declaramos bajo nuestra única responsabilidad que el producto a que hace referencia esta declaración estā conforme con la norma u otro documento normativo siguiendo las estipulaciones de la directiva 2004/108/CE.
 Noi dichiariamo sotto nostra esclusiva responsabilità che il prodotto a cui si riferisce la presente dichiarazione risulta conforme al seguente standard o altro documento normativo conforme alle disposizioni della direttiva 2004/108/CE.
 Wij verklaren als enige aansprakelijke, dat het product waarop deze verklaring betrekking heeft, voldoet aan de volgende norm of ander normatief document, overeenkomstig de bepalingen van Richtlijn 2004/108/EC.
 Vi erklærer os eneansvarlige for, at dette produkt, som denne deklaration omhandler, er i overensstemmelse med standard eller andre normative dokumenter i folgebestemmelse i direktiv 2004/108/EC.
 Vi deklarerer härmed vårt fulla ansvar för att den produkt till vilken denna deklaration hänvisar är i överensstämmelse med standarddokument eller annat normativt dokument som framställs i direktiv 2004/108/EC.
 Ilmoitamme yksinomaisella vastuullamme, että tuote, jota tämä ilmoitus koskee, noudattaa seuraavaa standardia tai muuta ohjeellista asiakirjaa, jotka noudattavat direktiivin 2004/108/EC säädokäytä.
 Vi erklærer oss alene ansvarlige for at produktet som denne erklæringer gjelder for, er i overensstemmelse med følgende norm eller andre normgivende dokumenter som følger bestemmelse i direktiv 2004/108/EC.

Important safety instructions

- Read these instructions.
- Keep these instructions.
- Heed all warnings.
- Follow all instructions.
- Do not block any ventilation openings. Install in accordance with the manufacturer's instructions.
- Do not install near any heat sources such as radiators, heat registers, stoves, or other apparatus (including amplifiers) that produce heat.
- Only use attachments/accessories specified by the manufacturer.
- Use only with the cart, stand, tripod, bracket, or table specified by the manufacturer, or sold with the apparatus. When a cart is used, use caution when moving the cart/apparatus combination to avoid injury from tip-over.
- Unplug this apparatus during lightning storms or when unused for long periods of time.
- Refer all servicing to qualified service personnel. Servicing is required when the apparatus has been damaged in any way, such as power-supply cord or plug is damaged, liquid has been spilled or objects have fallen into the apparatus, the apparatus has been exposed to rain or moisture, does not operate normally, or has been dropped.



Main functions

- Corresponding to outdoor use**
 This unit complies with waterproof and is able to install outdoors. (JIS C0920 compliant IP55)
- H.264 and JPEG triple encoding**
 A total of 3 outputs, comprising of 2 H.264 outputs and 1 JPEG output, can be provided.
- Power over Ethernet function**
 When connecting with a PoE (Power over Ethernet) device, power will be supplied by simply connecting a LAN cable. (IEEE802.3af compliant)
- Adaptive darkness correction**
 Corrects the blacked-out parts of dark areas of objects that have different illumination intensities.
- Panning/tilting function and preset position function**
 A single camera provides wide area monitoring.
- Interactive communication with audio**
 By using the audio output connector and the microphone in connector, receiving audio from the cameras on a PC and transmitting audio from the PC to the cameras is available.
- SDHC/SD memory card slot equipped**
 It is possible to save H.264 videos and JPEG images on the SDHC/SD memory card manually at an alarm occurrence, during the period of the schedule, or on a web browser. It is also possible to save JPEG images at a network failure occurrence. (Download is possible.)

Standard accessories

Confirm the following items are included in the camera's packaging.

Installation Guide (this document) (1 set)
 Warranty card (1 set)
 CD-ROM*1 (1 pc.)
 Code label*2 (1 pc.)

*1 The CD-ROM contains the operating instructions and different kinds of tool software programs.
 *2 This label may be required for network management. The network administrator shall retain the code label.

Precautions for Installation

Panasonic assumes no responsibility for injuries or property damage resulting from failures arising out of improper installation or operation inconsistent with this documentation.

Installation area for this product

- Select an appropriate place for the installation area (such as a strong wall or ceiling) in your particular environment.
- Avoid installing the camera in locations where it can be exposed to direct sunlight or rain from all directions. Install the camera in an appropriate location such as on an exterior wall of a building.

Do not place this product in the following places:

- Locations where a chemical agent is used such as a swimming pool
- Locations subject to humidity, dust, steam and oil smoke
- Locations that have a specific environment that is subject to an inflammable atmosphere or solvents
- Locations where a radiation, an X-ray, a strong radio wave or a strong magnetic field is generated
- Locations where corrosive gas is produced, Locations where it may be damaged by briny air such as seashores
- Locations where the temperature is not within the specified range (-20°C to +50°C [-4°F to +122°F]).

Dustproof/ Waterproof: IP55*
 * Only when installation work specified in this book is properly performed and appropriate waterproof treatment is performed

Locations subject to vibrations (This product is not designed for on-vehicle use.)

- Locations subject to condensation as the result of severe changes in temperature

Be sure to remove this product if it is not in use.

Before installation

- When this camera is mounted on a wooden ceiling or a wall, use the wood screws (accessory, Screw B). Screws to be used for other materials are not provided. Prepare the screws according to the material, structure, strength and other factors of the mounting area and the total weight of objects to be mounted.
- Ensure that the mounting surface, anchor and screws are sufficiently strong.
- Do not mount this product on a plaster board or a wooden section because they are too weak. If this product is unavoidably mounted on such a section, the section shall be sufficiently reinforced.

Design and engineer the power supply system to turn on/off the power of this product.
 The product has no power switch. When installing the product, use a power supply device equipped with the ON-OFF switch for servicing.

About the network connection
 When connecting to a network using the network cable of this product, observe the following. When wiring for the network, design and engineer not to be affected by thunder.

Screw tightening

- The screws and bolts must be tightened with an appropriate tightening torque according to the material and strength of the installation area.
- Do not use an impact driver. Use of an impact driver may damage the screws or cause tightening excessively.
- When a screw is tightened, make the screw at a right angle to the surface. After tightening the screws or bolts, perform visual check to ensure tightening is enough and there is no backlash.

Procure fixing screws that are not made to be used with wooden surfaces separately.
 The fixing screws supplied with this product are only for use with wooden surfaces. Required pull-out capacity of a single screw/bolt is 294 N (66.09 lbf) or more.

Fall prevention measures
 When the external safety wire is connected, select a connection point resulting in that nothing will hit people after the stand is damaged.

Do not remove or loosen the internal camera screws.
 Do not loosen the internal camera screws. Otherwise, water exposure may cause damage or malfunction of camera, or camera dropping may result in injury.

Radio disturbance
 When this product is used near TV/radio antenna, strong electric field or magnetic field (near a motor, a transformer or a power line), images may be distorted and noise sound may be produced.

PoE (Power over Ethernet)
 Use a PoE hub/device that is compliant with IEEE802.3af standard.

Router
 When connecting this product to the Internet, use a broadband router with the port forwarding function (NAT, IP masquerade). Refer to the Operating Instructions (included in the CD-ROM) for further information about the port forwarding function.

Time & date setting
 It is necessary to set the time & date before putting this product into operation. Refer to the Operating Instructions on the provided CD-ROM for descriptions of how to perform the settings.

Troubleshooting

Before asking for repairs, check the symptoms with the following table.
 Contact your dealer if a problem cannot be solved even after checking and trying the solution in the table or a problem is not described below.

Symptom	Cause/solution
Power is not turned on.	<ul style="list-style-type: none"> Are the PoE device and the network cable of the camera connected using a LAN cable? -- Check whether the connection is appropriately established. Depending on the PoE device, the power supply will stop when the demanded power exceeds its total power limit for all PoE ports. -- Refer to the operating instructions of the PoE device in use.

Option

You will need the following additional items to install and configure the camera.

[Locally procured]

- PoE device (When supplying the power using the PoE device)
- PC (see the system requirements in the Important Information document)
- a router
- a LAN cable (CAT-5 straight cable)
- AC Adaptor (1 pc.)
- * ONLY CONNECT 12 V DC CLASS 2 POWER SUPPLY (UL 1310/CSA 223) or LIMITED POWER SOURCE (IEC/EN/UL/CSA 60950-1).

About the user manuals

There are 2 sets of operating instructions for the WV-SW175, WV-SW172 as follows.

- Installation Guide: Explains how to install and connect devices, as well as how to connect and configure the network.
- Operating Instructions (included in the CD-ROM): Explains how to perform the settings and how to operate this camera.

Adobe® Reader® is required to read these operating instructions on the provided CD-ROM. When the Adobe® Reader® is not installed on the PC, download the latest Adobe Reader from the Adobe web site and install it.
 SW175, SW172 shown in the instructions and illustrations used in these operating instructions indicates the WV-SW175, WV-SW172.
 English screens are used in these operating instructions.

Limitation of liability

THIS PUBLICATION IS PROVIDED "AS IS" WITHOUT WARRANTY OF ANY KIND, EITHER EXPRESS OR IMPLIED, INCLUDING BUT NOT LIMITED TO, THE IMPLIED WARRANTIES OF MERCHANTABILITY, FITNESS FOR ANY PARTICULAR PURPOSE, OR NON-INFRINGEMENT OF THE THIRD PARTY'S RIGHTS. THIS PUBLICATION COULD INCLUDE TECHNICAL INACCURACIES OR TYPOGRAPHICAL ERRORS. CHANGES ARE ADDED TO THE INFORMATION HEREIN, AT ANY TIME, FOR THE IMPROVEMENTS OF THIS PUBLICATION AND/OR THE CORRESPONDING PRODUCT (S).

Disclaimer of warranty

IN NO EVENT SHALL Panasonic Corporation BE LIABLE TO ANY PARTY OR ANY PERSON, EXCEPT FOR REPLACEMENT OR REASONABLE MAINTENANCE OF THE PRODUCT, FOR THE CASES, INCLUDING BUT NOT LIMITED TO BELOW:

- ANY DAMAGE AND LOSS, INCLUDING WITHOUT LIMITATION, DIRECT OR INDIRECT, SPECIAL, CONSEQUENTIAL OR EXEMPLARY, ARISING OUT OF OR RELATING TO THE PRODUCT;
- PERSONAL INJURY OR ANY DAMAGE CAUSED BY INAPPROPRIATE USE OR NEGLIGENT OPERATION OF THE USER;
- ALL MALFUNCTIONS OR TROUBLES FROM UNAUTHORIZED DISASSEMBLE, REPAIR OR MODIFICATION OF THE PRODUCT BY THE USER, REGARDLESS OF THE CAUSE OF THE MALFUNCTION OR TROUBLE;
- INCONEVENIENCE OR ANY LOSS ARISING WHEN IMAGES ARE NOT DISPLAYED, DUE TO ANY REASON OR CAUSE INCLUDING ANY FAILURE OR PROBLEM OF THE PRODUCT;
- ANY PROBLEM, CONSEQUENTIAL INCONVENIENCE, OR LOSS OR DAMAGE, ARISING OUT OF THE SYSTEM COMBINED BY THE DEVICES OF THIRD PARTY;
- ANY CLAIM OR ACTION FOR DAMAGES, BROUGHT BY ANY PERSON OR ORGANIZATION BEING A PHOTOGENIC SUBJECT, DUE TO VIOLATION OF PRIVACY WITH THE RESULT OF THAT SURVEILLANCE-CAMERA'S PICTURE, INCLUDING SAVED DATA, FOR SOME REASON, BECOMES PUBLIC OR IS USED FOR ANY PURPOSE;
- LOSS OF REGISTERED DATA CAUSED BY ANY FAILURE.

System requirements for a PC

CPU: Intel® Core™ 2 Duo 2.4 GHz or faster recommended
Memory: 512 MB or more (A minimum of 1 GB memory is required when using Microsoft® Windows® 7 or Microsoft® Windows Vista®.)

Network interface: 10BASE-T/100BASE-TX 1 port
Monitor: Image capture size: 1024 x768 pixels or more
 Color: 24-bit True color or better

OS: Microsoft® Windows® 7
 Microsoft® Windows Vista®
 Microsoft® Windows® XP SP3
 Windows® Internet Explorer® 9.0 (32-bit)
 Windows® Internet Explorer® 8.0 (32-bit)
 Windows® Internet Explorer® 7.0 (32-bit)
 Microsoft® Internet Explorer® 6.0 SP3

Web browser: CD-ROM drive
 (It is necessary to read the operating instructions and use the software on the provided CD-ROM.)
 DirectX® 9.0c or later
 Adobe® Reader®
 (It is necessary to view PDF file on the provided CD-ROM.)

IMPORTANT

- When using a PC that does not meet the above requirements, displaying of images may become slower or the web browser may become inoperable.
- Microsoft Windows 7 Starter, Microsoft Windows Vista Starter and Microsoft Windows XP Professional 64-bit Edition are not supported.
- When using IPv6 for communication, use Microsoft Windows7 or Microsoft Windows Vista.

Note
<ul style="list-style-type: none"> For further information about PC system requirements and precautions for when using Microsoft Windows 7, Microsoft Windows Vista, or Windows Internet Explorer, click "Manual" - "Open" from the supplied CD-ROM and refer to "Notes on Windows" / Internet Explorer® versions". If using Microsoft Windows XP, screen tearing* may occur when the shooting scene drastically changes (for example, while shooting fast-moving subjects) due to the GDI restrictions of the OS. * A phenomenon in which portions of the screen are displayed out of alignment. For information on the operation/verification of the supported operating systems and web browsers, refer to our website (http://security.panasonic.com/ps/security/support/index.html).

Specifications

● Basic	
Power source:	PoE (IEEE802.3af compliant), 12 V DC
Power consumption:	PoE: 130 mA (Class 2 device), 12 V DC: 430 mA
Ambient operating temperature:	-20 °C to +50 °C (-4 °F to +122 °F)
Ambient operating humidity:	Less than 90 % (no condensation)
Monitor output:	VBS: 1.0 V [p-p]/75 Ω, composite (BNC), ø3.5 mm mini jack
EXT I/O terminal cable:	ALARM IN 1, ALARM IN 2/ALARM OUT, ALARM IN 3/ AUX OUT, GND, 12 V DC
Microphone/Line input:	ø3.5 mm monaural mini jack Input impedance: Approx. 2.2 kΩ For microphone input Applicable microphone: Plug-in power type Supply voltage: 3.3 V ±0.5 V For line input Input level: Approx. -10 dBV
Audio output:	ø3.5 mm stereo mini jack (monaural output) Output impedance: Approx. 560 Ω Line level
Dustproof/ Waterproof:	IP55* * Only when installation work specified in this book is properly performed and appropriate waterproof treatment is performed
Dimensions:	100 mm (W) x 100 mm (H) x 74 mm (D) [3-15/16 inches (W) x 3-15/16 inches (H) x 2-29/32 inches (D)] (excluding projection)
Mass:	Main body: 350 g (0.77 lbs)
Finish:	Main body : PC/ABS resin, silver Dome section: Clear polycarbonate resin

● Camera	
Image sensor:	1/4 type MOS image sensor
Effective pixels:	Approx. 1.3 megapixels
Scanning area:	3.52 mm (H) x 2.84 mm (V) [1/8 inches (H) x 3/32 inches (V)]
Scanning system:	Progressive
Minimum illumination:	Color: 0.6 lx [0.06 footcandle] (F2.2, Auto slow shutter: Off (1/30 s), Gain: On (High)) 0.038 lx [0.0038 footcandle] (F2.2, Auto slow shutter: max. 16/30 s, Gain: On (High))* BW: 0.5 lx [0.05 footcandle] (F2.2, Auto slow shutter: Off (1/30 s), Gain: On (High)) 0.031 lx [0.0031 footcandle] (F2.2, Auto slow shutter: max. 16/30 s, Gain: On (High))* * Converted value
Wide dynamic range:	On/Off
Face WDR:	On/Off
Gain (AGC):	On (Low)/ On (Mid)/ On (High)/ Off
Adaptive black stretch:	On/Off
Light control mode setting:	Indoor scene (50Hz/60Hz)/ELC
ELC (Maximum exposure time):	ELC(1/30 s), ELC(3/100 s), ELC(3/120 s), ELC(2/100 s), ELC(2/120 s), ELC(1/100 s), ELC(1/120 s), ELC(1/250 s), ELC(1/500 s), ELC(1/1000 s), ELC(1/2000 s), ELC(1/4000 s), ELC(1/10000 s)
Auto slow shutter:	Off (1/30 s), Max. 2/30s, Max. 4/30s, Max. 6/30s, Max. 10/30s, Max. 16/30s
Day & Night (electrical):	Off/Auto
White balance:	ATW1/ ATW2/ AWC
Digital noise reduction:	High/Low
Video analytics:	On/Off (with the XML notification setting)
Face detection*:	
Privacy zone:	On/Off (up to 2 zones available)
Camera title on screen:	Up to 20 characters (alphanumeric characters, marks), On/Off
Video motion detection (MD alarm):	On/Off, (available at each preset)

● Lens	
Zoom ratio:	Extra zoom: 2x (under VGA resolution)
Digital (electronic) zoom:	8x (Max 16x combined with Extra Zoom under VGA)
Focal length:	1.95 mm
Maximum aperture ratio:	1: 2.2
Focus range:	∞ - 0.5 m
Angular field of view:	Horizontal: 85°, Vertical: 68°

● Panning/tilting platform	
Panning range:	-47.5° - +47.5°
Panning speed:	Manual: Approx. 5 °/s - 80 °/s, Preset: Up to approx. 80 °/s
Tilting range:	-45° to +10°
Tilting speed:	Manual: Approx. 5 °/s - 80 °/s, Preset: Up to approx. 80 °/s
Number of the preset positions:	64
Map shot:	Preset map-shot
Self return:	10 s/ 20 s/ 30 s/ 1 min/ 2 min/ 3 min/ 5 min/ 10 min/ 20 min/ 30 min/ 60 min

Trademarks and registered trademarks

- Adobe, Acrobat Reader, and Reader are either registered trademarks or trademarks of Adobe Systems Incorporated in the United States and/or other countries.
- Microsoft, Windows, Windows Vista, Internet Explorer, ActiveX, and DirectX are either registered trademarks or trademarks of Microsoft Corporation in the United States and/or other countries.
- Microsoft product screen shot(s) reprinted with permission from Microsoft Corporation.
- Intel and Intel Core are trademarks or registered trademarks of Intel Corporation in the United States and other countries.
- SDHC Logo is a trademark of SD-3C, LLC.
- iPad, iPhone, and iPod touch are registered trademarks of Apple Inc., registered in the U.S. and other countries.
- Android is a trademark of Google Inc. Use of this trademark is subject to Google Permissions.
- All other trademarks identified herein are the property of their respective owners.

Copyright

Distributing, copying, disassembling, reverse compiling and reverse engineering of the software provided with this product are all expressly prohibited. In addition, exporting any software provided with this product violating export laws is prohibited.

Network security

As you will use this unit connected to a network, your attention is called to the following security risks.

- Leakage or theft of information through this unit
- Use of this unit for illegal operations by persons with malicious intent
- Interference with or stoppage of this unit by persons with malicious intent

It is your responsibility to take precautions such as those described below to protect yourself against the above network security risks.

- Use this unit in a network secured by a firewall, etc.
- If this unit is connected to a network that includes PCs, make sure that the system is not infected by computer viruses or other malicious entities (using a regularly updated anti-virus program, anti-spam program, etc.).
- Protect your network against unauthorized access by restricting users to those who log in with an authorized user name and password.
- Apply measures such as user authentication to protect your network against leakage or theft of information, including image data, authentication information (user names and passwords), alarm mail information, FTP server information and DDNS server information.
- After the unit is accessed by the administrator, make sure to close the browser.
- Change the administrator password periodically.
- Do not install the camera in locations where the camera or the cables can be destroyed or damaged by persons with malicious intent.

Precautions



- Refer installation work to the dealer.**
 Installation work requires technique and experiences. Failure to observe this may cause fire, electric shock, injury, or damage to the product.
 ● Be sure to consult the dealer.
- Stop the operation immediately when something is wrong with this product.**
 When smoke goes up from the product, the smell of smoke comes from the product, or the exterior of the product has deteriorated, continued use will cause a fire or fall of the product resulting in injury, or damage to the product.
 ● Turn the power off immediately and contact qualified service personnel for service.
- Select an installation area that can support the total weight.**
 Selecting an inappropriate installation surface may cause this product to fall down or topple over, resulting in injury.
 ● Installation work shall be started after sufficient reinforcement.
- Periodic inspections shall be conducted.**
 Rust on the metal parts or screws may cause a fall of the product resulting in injury or accidents.
 ● Consult the dealer for the inspections.
- The screws and bolts must be tightened to the specified torque.**
 Failure to observe this may cause a drop resulting in injury or accidents.
- Do not install this product in locations subject to vibration.**
 Loosening of mounting screws or bolts may cause a fall of the product resulting in injury.
- The measures of protection against a fall of this product shall be taken.**
 Failure to observe this may cause a drop resulting in injury or accidents. Be sure to install the safety wire.
- Install this product in a location high enough to avoid people and objects from bumping the product.**
 Failure to observe this may cause a drop resulting in injury or accidents.
- Turn the power off when do wiring of this product.**
 Failure to observe this may cause electric shock. In addition, short circuit or wrong wiring may cause fire, resulting in injury.
- Do not attempt to disassemble or modify this product.**
 Failure to observe this may cause fire or electric shock. Consult the dealer for the repair or inspections.
- Do not insert any foreign objects.**
 This could permanently damage this product. Turn the power off immediately and contact qualified service personnel for service.
- Do not use this product in an inflammable atmosphere.**
 Failure to observe this may cause an explosion resulting in injury.
- Avoid installing this product in the locations where salt damage occurs or corrosive gas is produced.**
 Otherwise, the mounting portions will deteriorate and accidents such as a fall of the product may occur.
- Do not strike or give a strong shock to this product.**
 Failure to observe this may cause fire or injury.
- Do not rub the edges of metal parts with your hand.**
 Failure to observe this may cause injury.
- Do not touch this product or the connected cables during thunder (even in the process of work).**
 Failure to observe this may cause electric shock.
- Keep SDHC/SD memory cards (option) away from infants and children.**
 Otherwise, they may swallow the cards by mistake.
 ● In this case, consult a doctor immediately.

1 Check the installing place

Determining the mounting position

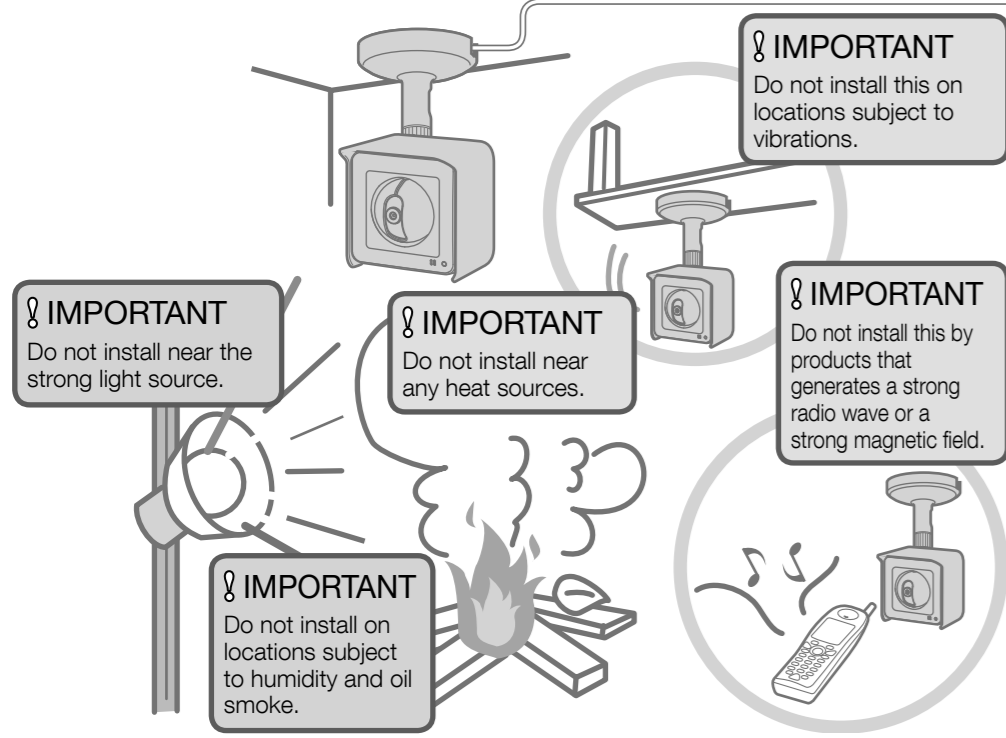

Determining how to wire the cable

It is necessary to make a hole in the ceiling or wall to pass the cables through. Make a hole 25 mm (31/32 inches) in diameter. (screw: Minimum pull-out strength (per 1 pc.) 196 N (44.06 lbf))

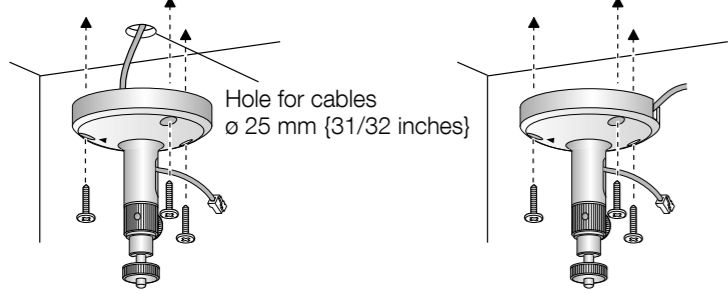

Determining the length of the cable

Confirm the distance from the camera's installation position to the computer and then prepare the necessary length of LAN cable (locally procured).



Determining how to mount the camera

■ Installing the camera on the ceiling or wall
Make sure the flexible stand is firmly mounted on a beam of wood (25 mm (31/32 inches) and greater) etc. When there is no beam, apply a board on the other side of the ceiling or wall to make sure the camera does not drop. (screw: Minimum pull-out strength (per 1 pc.) 196 N (44.06 lbf))

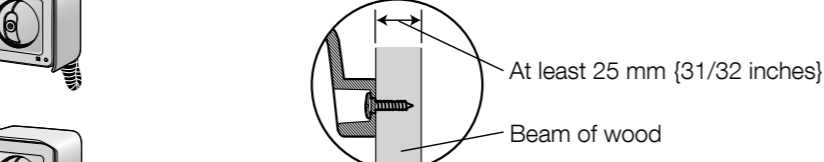

When mounting on a concrete surface

Prepare anchors for 4 mm (5/32 inches) diameter screws for mounting. Mortar ceilings or walls break easily when drilling. Be careful of pieces of mortar which may become loose and fall.

- Place the flexible stand on the ceiling or wall where you plan to mount the flexible stand and mark the points where you are going to make holes.
- Make holes with an electric drill. Insert anchors (locally procured) into the holes and push them inside the holes with a hammer.
- Mount the flexible stand using the screws.

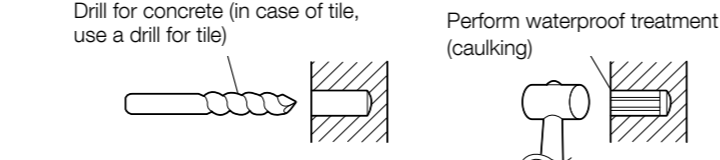

■ Tripod Mount
It is also possible to mount the camera on a standard tripod stand (locally procured).



2 Major operating controls

<Front view>

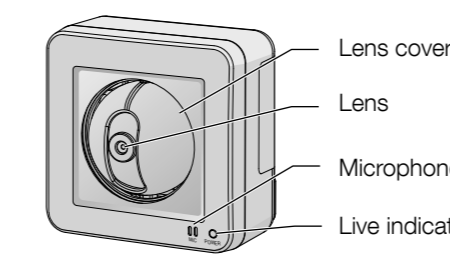

<Side and bottom view>

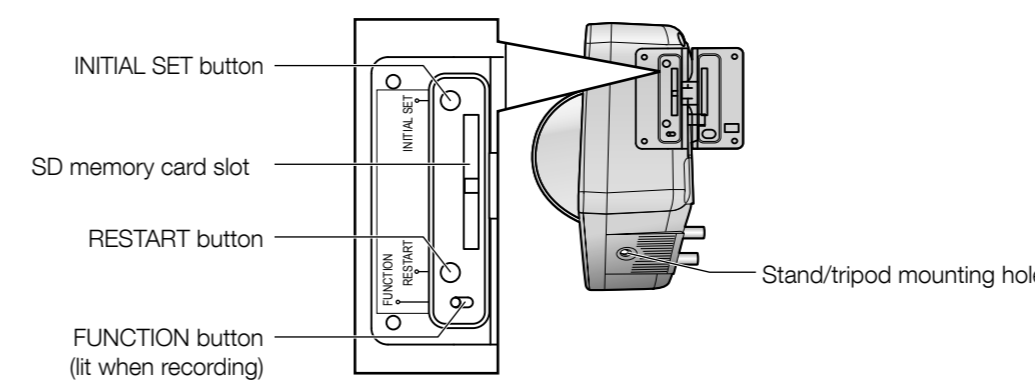

<Rear view>

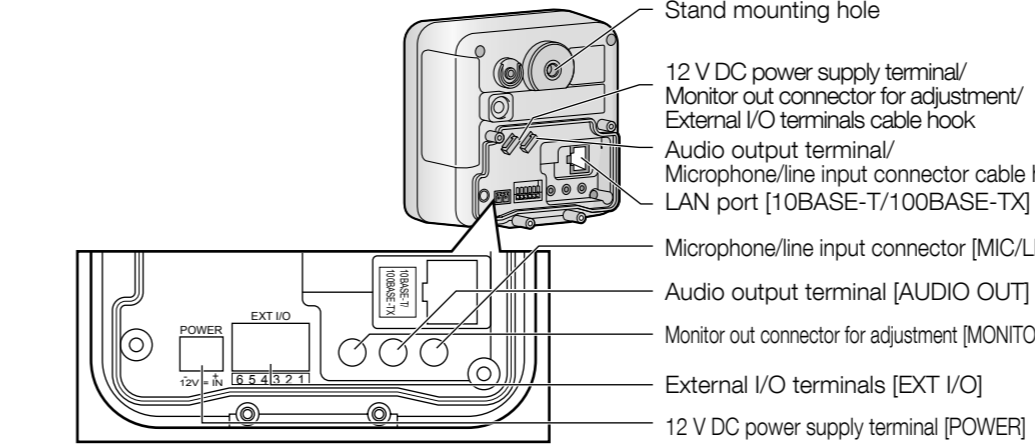

External I/O terminals

Pin	Function
6	DC power output • Power output voltage 10.5 V - 13 V • Power output current 100 mA
5	GND
4	GND
3	EXT I/O terminal 3 (ALARM IN 3/ AUX OUT)
2	EXT I/O terminal 2 (ALARM IN 2/ ALARM OUT)
1	EXT I/O terminal 1 (ALARM IN 1)

About the [INITIAL SET] button
After turning off the power of the camera, turn on the power of the camera while holding down this button, and wait for around 5 seconds or more without releasing this button. Wait around 3 minutes after releasing the button. The camera will start up and the settings including the network settings will be initialized. Before initializing the settings, it is recommended to write down the settings in advance. The initialization will be complete when the live indicator stops blinking orange and lights off. Note that the preset position settings and the CRT key (SSL encryption key) used for the HTTPS protocol will not be initialized.

IMPORTANT
Do not turn off the power of the camera during the process of initialization. Otherwise, it may fail to initialize and may cause malfunction.

About the [RESTART] button
When the camera is on, you can also restart the camera by pressing the RESTART button. Press and hold the RESTART button for about one second with a pointed object. Restarting is completed when the camera's pan/tilt performs its initial movement.

3 Connections

When connecting the camera using PoE (Power over Ethernet)

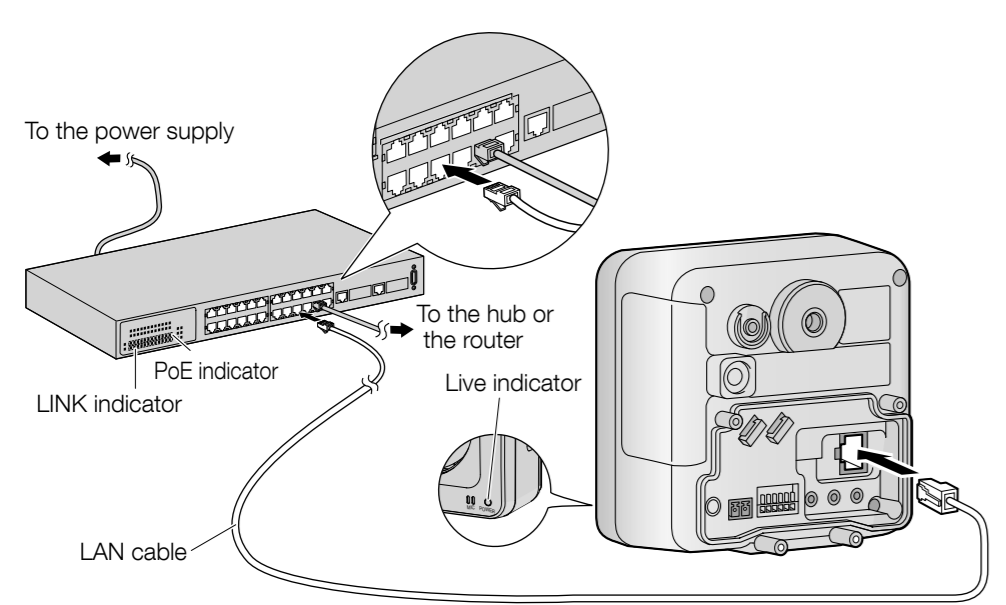

Note

- If the live indicator does not turn green, see "Troubleshooting" in the Operating Instructions on the provided CD-ROM.
- Refer to the operating instructions of the product in use about the operations of the PoE device.

IMPORTANT

- Use a 4-pair UTP/STP cable.
- Make sure that the PoE device in use is compliant with IEEE802.3af standard.
- For information on recommended PoE devices, refer to our website at (<http://panasonic.net/ps/security/support/info.html>).

When connecting the camera using 12 V DC power supply

Caution:
● ONLY CONNECT 12 V DC CLASS 2 POWER SUPPLY (UL 1310/CSA 223) or LIMITED POWER SOURCE (IEC/EN/UL/CSA 60950-1).

- Loosen the screw of the power cord plug (accessory).
- Connect the cable of the 12 V DC power supply to the power cord plug. Strip 3 mm to 7 mm (1/8 inches to 9/32 inches) from the end of the wire, and twist the stripped part of the wire sufficiently to avoid short circuit. Specification of cable (wire): 16 AWG - 24 AWG, Single core, twisted. Check whether the stripped part of the wire is not exposed and is securely connected.
- Tighten the screw of the power cord plug. (Recommended tightening torque: 0.34 N·m (0.25 lbf·ft))
- Connect the power cord plug to the 12 V DC power supply terminal on the rear of the camera.

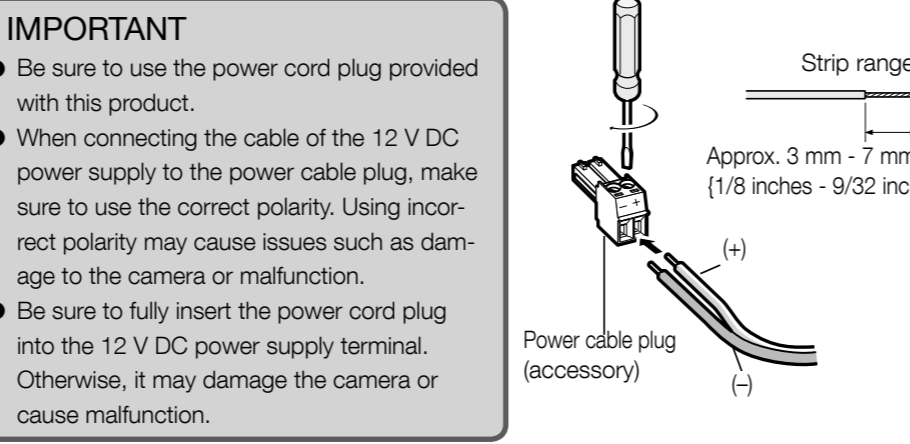

IMPORTANT

- Be sure to use the power cord plug provided with this product.
- When connecting the cable of the 12 V DC power supply to the power cable plug, make sure to use the correct polarity. Using incorrect polarity may cause issues such as damage to the camera or malfunction.
- Be sure to fully insert the power cord plug into the 12 V DC power supply terminal. Otherwise, it may damage the camera or cause malfunction.

WARNING

Adequate waterproof treatment is required for the AC adaptor* and the AC cord*. (The AC adaptor and the AC adaptor cord are not waterproof.) Failure to observe this may cause fire or electric shock. Never touch wet AC adaptors or AC cords. Consult the dealer for repair. *1 Only when receiving power from the AC adaptor.

External I/O terminals

Connect external devices to the EXT I/O terminal. When connecting an external device, remove 9 mm - 10 mm (11/32 inches - 13/32 inches) of the outer jacket of the cable and twist the cable core to prevent the short circuit first. ● Specification of cable (wire): 22 AWG - 28 AWG, Single core, twisted

IMPORTANT

- Do not connect 2 wires or more directly to a terminal. When it is necessary to connect 2 or more wires, use a splitter.
- Input and output of the external I/O terminal 2 and 3 can be switched by configuring the setting. The default of EXT I/O terminal 2 is "ALARM IN 2" and of EXT I/O terminal 3 is "ALARM IN 3". It is possible to determine whether or not to receive input from EXT I/O terminal 2 and 3 (ALARM IN 2, 3) by selecting "Off", "Alarm input", "Alarm output" or "AUX output" for "Terminal alarm 2" or "Terminal alarm 3" on the [Alarm] tab on the "Alarm setup" page. Refer to the Operating Instructions (included in the CD-ROM) for further information.
- The default of EXT I/O terminals is "Off". When "Off" is selected, it is possible to connect external devices as well as the input setting.
- When using the EXT I/O terminals as the output terminals, ensure they do not cause signal collision with external signals.
- In order for the EXT I/O terminal to detect alarm inputs when the terminal status is changed from Open to Close (On) or from Close to Open (Off), about 100 ms or more is needed. Because alarms cannot be detected for about 5 seconds after a detection is made, alarm inputs received within about 5 seconds after an alarm is detected are not detected.

<Ratings>

- ALARM IN 1, ALARM IN 2, ALARM IN 3
Input specification : No-voltage make contact input (4 V - 5 V DC, internally pulled up)
Off : Open or 4 V - 5 V DC
On : Make contact with GND (required drive current: 1 mA or more)
- ALARM OUT, AUX OUT
Output specification : Open collector output (maximum applied voltage: 20 V DC)
Open : 4 V - 5 V DC by internal pull-up
Close : Output voltage 1 V DC or less (maximum drive current: 50 mA)

Microphone/line input connector • Audio output terminal

You can connect an external microphone and external speaker to the camera to use the Listen and Talk features, respectively. The microphone cable should be no longer than 7 m (23 feet). If you use an external microphone, excessive cable length or a poor quality cable can cause degradation in audio quality.

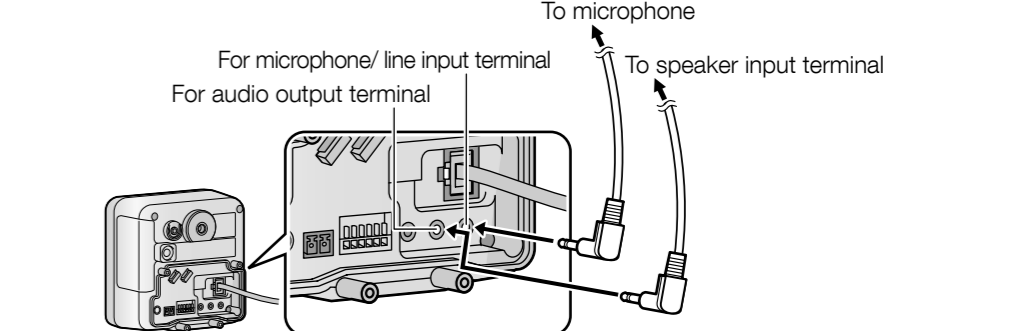
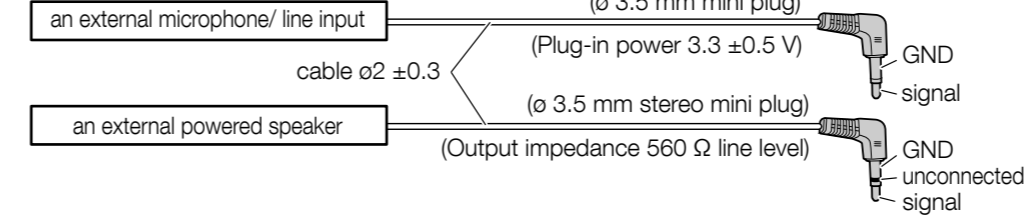

Monitor out connector for adjustment

Connect a monaural mini plug (ø3.5 mm) (only for checking if images are displayed on the monitor).

IMPORTANT

- The monitor out connector for adjustment is provided only for checking the adjustment of the angular field of view on the video monitor when installing the camera or when servicing. It is not provided for recording/monitoring use.
- Black bands may appear at the top and bottom or right and left of the screen. (That does not affect the adjustment because the angular field of view is not changed.)

Insert a SD memory card

- Open the cover on the side of the camera.

- Insert the SD memory card with the label facing the rear of the camera and the pins facing the front of the camera. Gently push the card with your finger until it clicks.

Note

- If the camera's live indicator turns red, remove the SD memory card and confirm that the card is not write-protected. If the live indicator is still red, the card must be formatted before it can be used.

4 Configure the settings of the camera

Configuring the camera so that it can be accessed from a PC

If you are using firewall software on your PC, the Setup Program may not be able to find any cameras on your network. Configure the setting of the camera after temporarily invalidating the firewall software.

- Insert the provided CD-ROM into the CD-ROM drive of your PC
 - The License Agreement will be displayed. Read the Agreement and choose "I accept the term in the license agreement", and click [OK].
 - The launcher window will be displayed. If the launcher window is not displayed, double click the "CDLauncher.exe" file on the CD-ROM.

Note

- Refer to "Using the CD-ROM" in the Operating Instructions on the provided CD-ROM for further information about CDLauncher.



Click the [Run] button next to [IP Setting Software]

"Panasonic IP Setting Software" page will be displayed. Click the [Network Settings] button after selecting the MAC address/IP address of the camera to be configured.

- Select the camera you want to configure, and click [Access Camera].

Note

- When cameras are displayed in [IP Setting Software] screen, click the camera with same MAC address as the MAC address printed on the camera that you want to configure.



It is necessary to install the viewer software "Network Camera View 4S" to display images. Follow the instructions of the wizard to start the installation.

- The "Live" page will be displayed.
- Perform the [Time & date] settings in the "Setup" - "Basic" page before using the camera.



Note

- When no image is displayed on the "Live" page, refer to "Troubleshooting" in the Operating Instructions on the provided CD-ROM.
- It is possible to enhance the network security by encrypting the access to cameras using the HTTPS function. Refer to "Access the camera using the HTTPS protocol" in the Operating Instructions on the provided CD-ROM.
- Click the [Setup] button on the "Live" page, the user authentication window will be displayed. Enter the default user name and password as follows, and log in. User name: admin Password: 12345

Close the cover.

IMPORTANT

- Make sure that the cover is completely closed after inserting the SD memory card. If there is a gap between the cover and the camera, rain or other liquids may enter inside the camera and cause damage to the camera.

Remove a SD memory card

- Close the slide cover on the side of the camera.
- Press the FUNCTION button. When the FUNCTION button is pressed, recording stops and the green light turns off. Confirm that the FUNCTION button green light has turned off before proceeding to step 3.

- Push the card slightly to eject it, then remove the card.

Close the cover.

IMPORTANT

- Make sure that SD memory card recording has stopped and that the card is not being accessed before removing the card. (The FUNCTION button will light while images are being recorded to the card.) We recommend pressing the FUNCTION button to stop SD memory card recording before ejecting the card.
- If the SD memory card is removed while it is being recorded to or accessed, the card may become unreadable and may need to be formatted (i.e., erased) again before use.
- Make sure that the cover is completely closed after removing the SD memory card. If there is a gap between the cover and the camera, rain or other liquids may enter inside the camera and cause damage to the camera.

5 Mounting the Camera

Refer to "Mounting the Camera" (leaflet) for descriptions of how to mount the camera outdoors in the fields of U.S. and Canada.

- Remove the tab on the flexible stand (accessory), and then pass the cables through the notch.

Note

 - When passing all cables through a duct (locally procured) for waterproofing without removing the tab, wrap the cables to the shaft of the stand with tape or other materials (locally procured). In this case proceed to step 2.

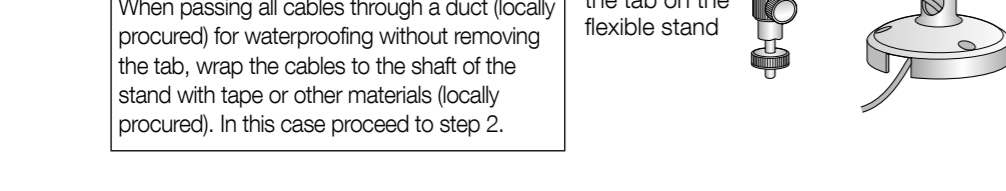

- Pass the cables through the connector cover (accessory), and then connect all cables. Attach the connector cover by fastening screw A (accessory). (Recommended tightening torque of the connector cover: 0.6 N·m (0.44 lbf·ft))

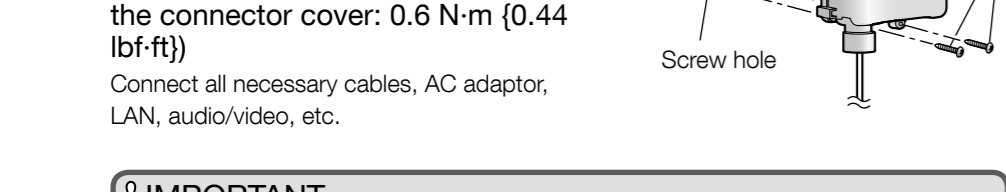

Connect all necessary cables, AC adaptor, LAN, audio/video, etc.

IMPORTANT

- When wiring LAN cables outside, make the LAN cable as short as possible. This product or the hub connected to this product may be affected by lightning or other weather conditions.
- When mounting the camera, make sure to wrap the AC adaptor cord (if used) and other cables (external microphone or speaker cable, video cable, etc.) around the hooks as shown to ensure secure connections.

- Attach the sunshade (accessory) by fastening screw A. (Recommended tightening torque of the sunshade: 0.6 N·m (0.44 lbf·ft))

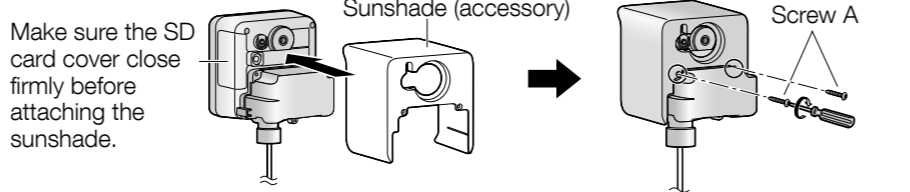

- Wrap the cables in the included foam strip (accessory) and insert the foam strip into the opening of the connector cover leaving about 10 mm (3/8 inches) of the foam exposed, as shown.

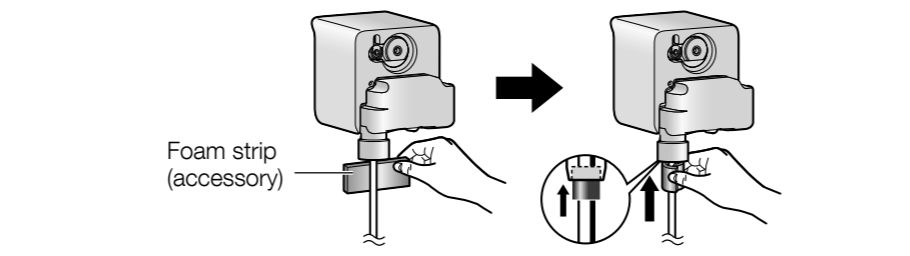

Note

- Adequate waterproof treatment is required for the cables when installing the camera outdoors. Failure to observe this may cause water leakage resulting in malfunction.

- Wrap the first 20 cm (7 7/8 inches) of the cables (starting with the connector cover) using the included self bonding tape (accessory). Make sure to wrap the opening of the connector cover thoroughly (three or four times). Stretch the tape to twice its length when you wrap the cables. When mounting the camera on a tripod, make sure to wrap the self bonding tape (locally procured) around the cables until a suitable height according to the height of the tripod.

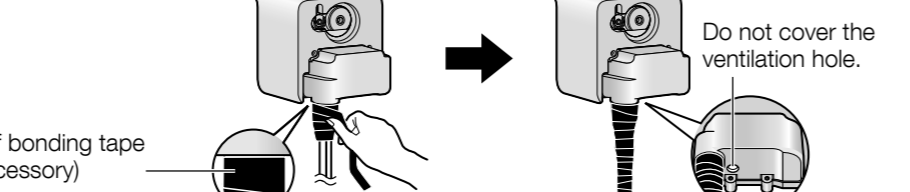

Installing the camera on the ceiling or wall

Adjust the camera to a suitable position/direction while confirming the images actually displayed on the computer screen.

- Place the flexible stand on the ceiling or wall, and determine the mounting position of the stand.

Note

 - Make sure the live indicator is always in the lower right corner when you mount.

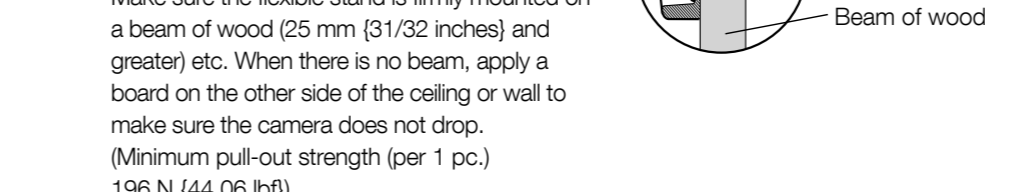

- Secure the safety wire (accessory) to the camera using screw A (accessory) and washer S (accessory). (Recommended tightening torque: 0.6 N·m (0.44 lbf·ft))

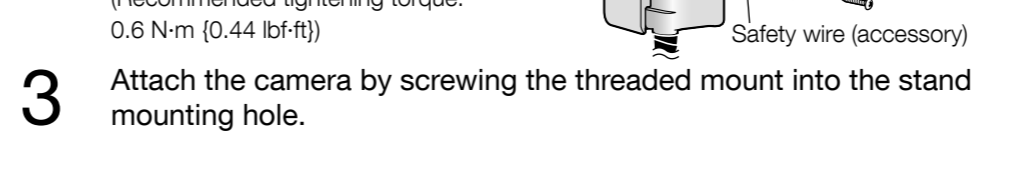

- Attach the camera by screwing the threaded mount into the stand mounting hole.
 - Ceiling: Grip, Threaded mount, Stand mounting hole
 - Wall: Stand/tripod mounting hole, Live indicator, Threaded mount, Grip

* It is possible to attach the stand to the stand mounting hole, the rear of the camera.

Mount the flexible stand firmly to the ceiling or wall with screw B (accessory).

When mounting the flexible stand to the wall, position the flexible stand so that the "▲" marker is facing upward. (screw B: Minimum pull-out strength (per 1 pc.) 196 N (44.06 lbf))

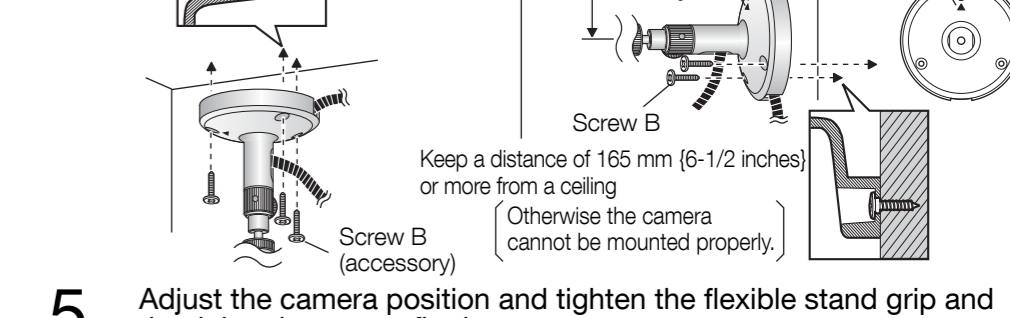

- Adjust the camera position and tighten the flexible stand grip and the tightening screw firmly. The fixing position of the tightening screw can be adjusted according to the direction the camera is facing and its angle.

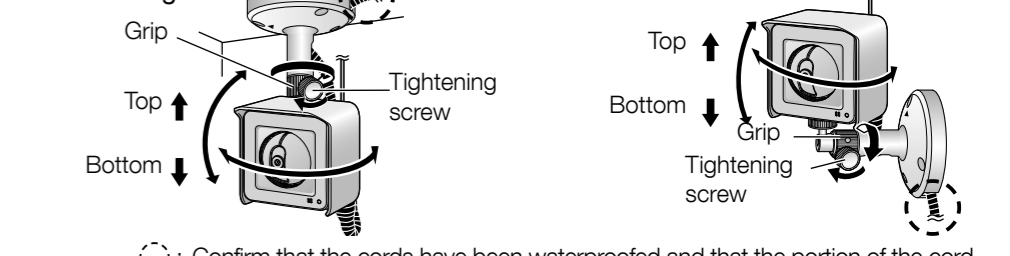

- Adjust the length of the safety wire when it is taut, and secure it to the ceiling or wall using screw B (accessory) and washer L (accessory). Attach the safety wire in a position so that if the camera were to become detached, it would not fall on nearby people. (screw B: Minimum pull-out strength (per 1 pc.) 196 N (44.06 lbf))
 - Ceiling: Make sure to waterproof the opening of the duct so that water does not enter it.
 - Wall: Screw B, Washer L (accessory)

