

# Panasonic®

## Operating Instructions

### HDD Viewer Software

Model No. **WJ-NX200K, WJ-NX200K/G**  
**WJ-NX300K, WJ-NX300K/G**  
**WJ-NX400K, WJ-NX400K/G**

This document is the HDD viewer operating instructions for WJ-NX200K, WJ-NX200K/G, WJ-NX300K, WJ-NX300K/G, WJ-NX400K and WJ-NX400K/G.

Before attempting to connect or operate this product,  
please read these instructions carefully and save this manual for future use.

The model number is abbreviated in some descriptions in this manual.

# CONTENTS

---

Preface .....	3
System Configuration.....	3
System requirements for a PC .....	4
Trademarks and registered trademarks .....	4
GPL/LGPL .....	4
Copyright.....	5
Disclaimer of warranty.....	5
Limitaion of liability.....	5
Operations flow .....	6
<b>1</b> Set password for HDD viewer .....	7
<b>2</b> Remove the HDD from the recorder .....	7
<b>3</b> Save HDD viewer (Compressed file) on USB medium and copy it to PC .....	7
<b>4</b> Unzip the HDD viewer (Compressed file) copied to the PC .....	7
<b>5</b> Connect the removed HDD to the PC .....	7
Operation.....	8
How to use the HDD viewer .....	8

# Preface

---

The HDD viewer (hereafter this software) is software to play video / audio stored on hard disk drives (hereafter, HDD) removed from network disk recorders of WJ-NX200K or WJ-NX200K/G, WJ-NX300K or WJ-NX300K/G, WJ-NX400K or WJ-NX400K/G (hereafter, recorders) on a personal computer (hereafter, PC).

With this software, you can search by date and time and other conditions, play back, and save and print still images.

## System Configuration

Connect the HDD removed from the recorder to the PC that has copied the software using a locally procured USB/SATA conversion cable.

\* Use this software without installing it.

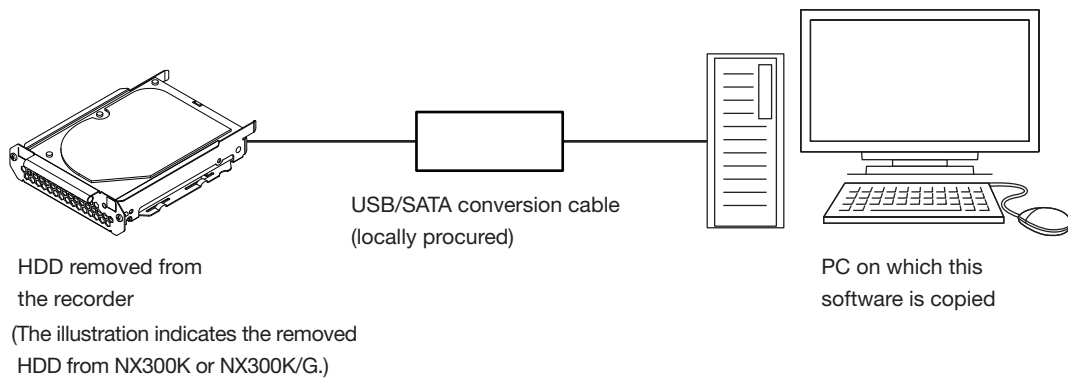

---

### Important:

- Do not delete or move files inside the HDD, since it may make HDD playback impossible.
-

---

## System requirements for a PC

It is recommended to operate this unit using a PC that meets the following system requirements.

OS:	Microsoft® Windows® 7*1, Microsoft® Windows® 8.1, Microsoft® Windows® 10
CPU:	Intel® Core™ i7-860
Memory:	4 GB or more
Monitor:	1024 × 768 pixels or more, 24-bit True color or better
USB port:	A port suited to your USB / SATA conversion cable specifications
Audio:	Sound card (When using the audio function)
Others:	CD-ROM drive: It is necessary to refer to the operating instructions on the provided CD-ROM. DirectX® 9.0c or later Adobe® Reader® : CD-ROM drive: It is necessary to refer to the operating instructions on the provided CD-ROM.

\*1 Windows® XP compatibility mode is unavailable.

---

### Important:

- If using a PC that does not meet the above system requirements, it may cause problems such as slow imaging.  
Microsoft® Windows® RT, Microsoft® Windows® 7 Starter and Microsoft Edge are not supported.
- When using Microsoft® Windows® 8.1, use it in the desktop. The software cannot be used in the Modern UI design.

---

### Note:

- Refer to "Notes about versions of Windows®/Internet Explorer®" (PDF) on the provided CD-ROM for further information about system requirements for a PC and precautions when using Microsoft® Windows®.

---

## Trademarks and registered trademarks

- Adobe, Acrobat Reader and Reader are either registered trademarks or trademarks of Adobe Systems Incorporated in the United States and/or other countries.
- Microsoft, Windows is a registered trademark, or trademark of Microsoft Corporation in the United States and/or other countries.
- Microsoft product screen shot(s) reprinted with permission from Microsoft Corporation.
- Intel and Intel Core are trademarks or registered trademarks of Intel Corporation in the United States and other countries.
- All other trademarks identified herein are the property of their respective owners.

## GPL/LGPL

- This product contains software licensed under GPL (GNU General Public License), LGPL (GNU Lesser General Public License), etc.
- Customers can duplicate, distribute and modify the source code of the software under license of GPL and/or LGPL.
- Refer to the "readme.txt" file on the provided CD-ROM for further information about the source code of the software contained in this product and copyright notice comprised in the GPL/LGPL software.
- Please note that Panasonic shall not respond to any inquiries regarding the source code.

---

## Copyright

Except for open source software licensed under GPL/LGPL and so on, distributing, copying, disassembling, reverse compiling and reverse engineering of the software provided with this product are all expressly prohibited. In addition, exporting any software provided with this product violating export laws is prohibited.

## Disclaimer of warranty

IN NO EVENT SHALL Panasonic i-PRO Sensing Solutions Co., Ltd. BE LIABLE TO ANY PARTY OR ANY PERSON, EXCEPT FOR REPLACEMENT OR REASONABLE MAINTENANCE OF THE PRODUCT, FOR THE CASES, INCLUDING BUT NOT LIMITED TO BELOW:

- (1) ANY LOSS OR DAMAGE, INCLUDING WITHOUT LIMITATION, DIRECT OR INDIRECT, SPECIAL, CONSEQUENTIAL OR EXEMPLARY, ARISING OUT OF OR RELATING TO THE PRODUCT;
- (2) ANY INCONVENIENCE, LOSS, OR DAMAGE CAUSED BY INAPPROPRIATE USE OR NEGLIGENT OPERATION OF THE USER;
- (3) ALL MALFUNCTIONS OR TROUBLES FROM UNAUTHORIZED DISASSEMBLE, REPAIR OR MODIFICATION OF THE PRODUCT BY THE USER, REGARDLESS OF THE CAUSE OF THE MALFUNCTION OR TROUBLE;
- (4) INCONVENIENCE OR ANY LOSS ARISING WHEN IMAGES ARE NOT DISPLAYED, DUE TO ANY REASON OR CAUSE INCLUDING ANY FAILURE OR PROBLEM OF THE PRODUCT;
- (5) ANY PROBLEM, CONSEQUENTIAL INCONVENIENCE, OR LOSS OR DAMAGE, ARISING OUT OF THE SYSTEM COMBINED BY THE DEVICES OF THIRD PARTY;
- (6) ANY CLAIM OR ACTION FOR DAMAGES BROUGHT BY ANY PERSON OR ORGANIZATION AS A PHOTOGRAPHED SUBJECT DUE TO VIOLATION OF PRIVACY CONCERNING A SURVEILLANCE CAMERA'S PICTURE OR SAVED DATA, FOR SOME REASON (INCLUDING USE WHEN USER AUTHENTICATION ON THE AUTHENTICATION SETTING SCREEN IS SET TO OFF), BECOMING PUBLIC OR BEING USED FOR ANY PURPOSE;
- (7) LOSS OF REGISTERED DATA CAUSED BY ANY FAILURE (INCLUDING INITIALIZATION OF THE PRODUCT DUE TO FORGOTTEN AUTHENTICATION INFORMATION SUCH AS A USER NAME AND PASSWORD).

## Limitation of liability

THIS PUBLICATION IS PROVIDED "AS IS" WITHOUT WARRANTY OF ANY KIND, EITHER EXPRESS OR IMPLIED, INCLUDING BUT NOT LIMITED TO, THE IMPLIED WARRANTIES OF MERCHANTABILITY, FITNESS FOR ANY PARTICULAR PURPOSE, OR NON-INFRINGEMENT OF THE THIRD PARTY'S RIGHT.

THIS PUBLICATION COULD INCLUDE TECHNICAL INACCURACIES OR TYPOGRAPHICAL ERRORS.

CHANGES ARE ADDED TO THE INFORMATION HEREIN, AT ANY TIME, FOR THE IMPROVEMENTS OF THIS PUBLICATION AND/OR THE CORRESPONDING PRODUCT (S).

# Operations flow

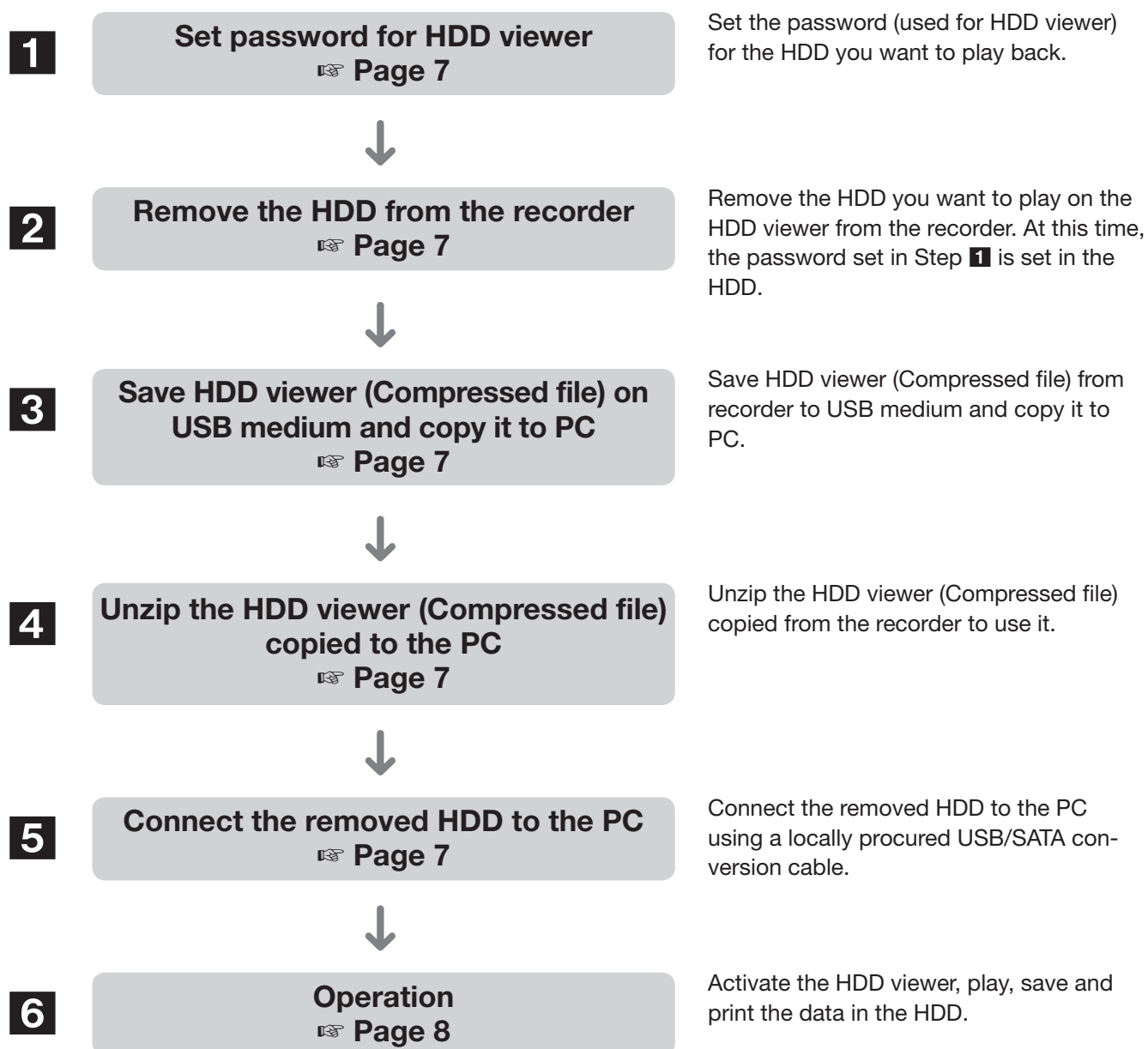

---

## 1 Set password for HDD viewer

Before removing the HDD from the recorder, set the password for the HDD viewer by Maintenance > HDD information in the recorder's setup menu. For the setting method, refer to [Set password for HDD viewer] and [Retype password] in the Operating Instructions.

---

**Note:**

- The set password is assigned to the HDD when the HDD is removed.
  - For playback only, error disc passwords are not set.
  - If you insert the removed HDD into another recorder, playback is possible regardless of whether or not there is a password.
  - When you install / format the removed HDD, the password setting saved in the HDD is deleted.
- 

## 2 Remove the HDD from the recorder

Remove the HDD you want to play on the HDD viewer from the recorder. For how to remove, refer to [Remove HDD] in the Operating Instructions and contact your dealer.

---

**Note:**

- HDDs running RAID 5 / RAID 6 mode cannot be played on the HDD viewer.
- 

## 3 Save HDD viewer (Compressed file) on USB medium and copy it to PC

Save the HDD viewer (compressed file: NX\_HDD\_Viewer.zip) from the recorder to the USB medium and copy it to the PC. For the method of saving to USB medium, refer to [Save HDD Viewer (to USB medium)] in the Operating Instructions.

Since it is saved in a compressed state right under the drive of the USB medium, copy it to an arbitrary location on the PC.

## 4 Unzip the HDD viewer (Compressed file) copied to the PC

Unzip the compressed HDD viewer (NX\_HDD\_Viewer.zip). When unzipped, NxHddViewer\_Install-less folder is created. There is an HDD viewer executable file (NxHddViewer.exe) in this folder. The HDD viewer can be used without installation.

## 5 Connect the removed HDD to the PC

Connect the removed HDD to the PC with a locally procured USB / SATA conversion cable. For the connection method, refer to the instruction manual of the USB / SATA conversion cable.

# Operation

## How to use the HDD viewer

To start the HDD viewer, double-click the executable file (NxHddViewer.exe) in the folder expanded in Step 4.

### Important:

- The HDD viewer requires a license for each PC. The recorder has 1 license for 1 PC. Additional licenses are required when you use the HDD viewer with 2 or more PCs at the same time. Contact your dealer for the license.

### Note:

- The license agreement window will be displayed when you first launch the viewer. The HDD viewer is launched when you accept the license agreement.

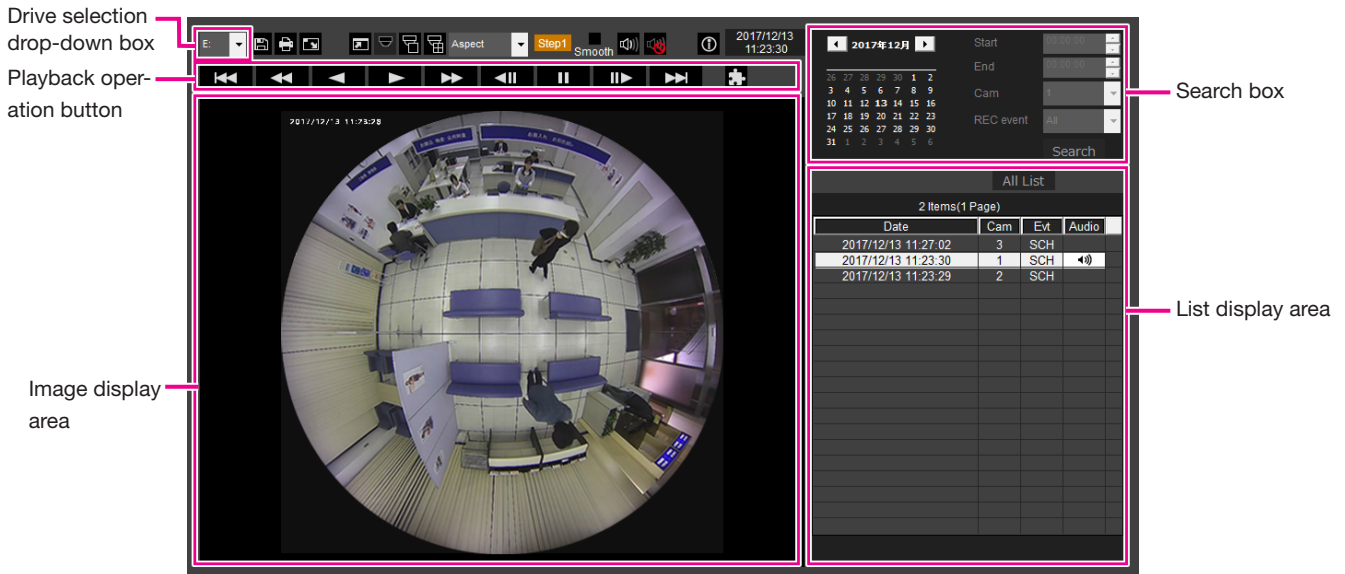

Normal window



Playback operation window when images are displayed on a full screen



## Select HDD drive

### STEP1

Select the drive number of the HDD containing the video you want to play from [Drive selection drop-down box] on the upper left of the HDD viewer.  
→The list of videos of the selected drive is displayed in the list display area.

### STEP2

The following contents are displayed in the list display area.



Date: Start time of recording is displayed.

Cam: Displays the camera number that recorded the image.

Evt: Event type is displayed.

Audio: When there is audio data,  is displayed.

### Note:

- If a password is set to the selected HDD, a password is requested. A list will be displayed only if it is confirmed that you have entered the correct password.
- Up to 100 logs can be displayed in the list. If the number of videos exceeds 100, you can turn to the next page by clicking the buttons  or  or .

## Video playback

### Play back a video by selecting it from the list

Selecting a line in the list display area will play that video.

Clicking it will pause playback at the first image and double-clicking will start the playback.

If the videos from the same camera are displayed on the list, the next list video in playback mode or the previous list video in reverse playback mode will be played back consecutively.

### Note:

- If a password is set to the video, a password will be requested. The video will be played only when the correct password is confirmed.
- Playback images and audio may sometimes not be synchronized exactly.

The playback operation buttons enable the following operations.

**[Play] button**

 : Starts the playback.

**[Rev play] button**

 : Plays the image backwards.

**[FF] button**

 : Plays the image at high speed.

**[FR] button**

 : Plays the image backwards at high speed.

**[Pause] button**

 : Pauses the playback.

**[Next image] button**

 : Moves to the next image. It is operable only when playback is paused.

**[Prev image] button**

 : Returns to the previous image. It is operable only when playback is paused.

**[Skip button] button**

 : Plays the next video with the same camera displayed in the list.

**[Reverse skip] button**

 : Plays the previous video with the same camera displayed in the list.

---

## Search and video playback

The date on which the videos exist is displayed in bold in the calendar; select the date in bold, enter search conditions (start and end time, camera and REC event), then click the **Search** button. Only the videos that meet the specified conditions will be displayed to the list and played from the start time.

The selected date is displayed with a red circle on the calendar.

When [All] is selected for the REC event, it filters by conditions other than event type.

Clicking the **All List** button will cancel the search conditions and display the original list.

## Make the image easy to see

### Display enlarged images

When setting a cursor on the image display and manipulating the mouse wheel, digital zoom is displayed.

Clicking the image during zoom display changes the screen center to the clicked position.

### Change the display size



: Enlarges the window display.



: Returns the enlarged window display to the original size.



: Display the image maximized to the whole window.

The maximized image to the whole window is returned to the original by the **Restore** button or the [Esc] key.

### Change the display format



**Aspect** : Displays the image in the screen with the aspect ratio kept.



**Scaling** : Displays the image with it expanded or contracted to fit in the screen.



**PixelByPixel** : Displays 1 pixel of the screen on 1 dot.

When you click the image in the screen of pixel by pixel, the center position changes to the point where you have clicked.

### Smooth the high-speed playback



**Smooth** : Checking the box enables a smooth, high-speed playback.

The fast playback speed may be limited depending on the performance of the PC in use or process status.

### Plays the fisheye image of the fisheye network camera (made by Panasonic, hereinafter called "fisheye camera")

When you select a fisheye image which can be corrected, the image will be corrected and displayed on 1-screen PTZ/4-screen PTZ.

After clicking the image during corrected display on 1-screen PTZ/4-screen PTZ, the clicked position will be centered on the screen.



: Returns the image to the fisheye image.



: Corrects the image on 1-screen PTZ.



: Corrects the image on 4-screen PTZ.

## Adjust the volume

When the audio data is available, a button to adjust the audio will be displayed.



: Adjusts the volume. Clicking the button can switch the volume in three levels.



: Toggles Audio playback/Silent.

If the audio is controlled or adjusted by another application, the audio may not be played correctly on the HDD viewer. To play the audio correctly, adjust the audio only with the HDD viewer.

## Save still images

Images that are displayed in the pause state on the image display area can be saved as a JPEG file.



: Name and save paused images.

## Export the video as a file

You can export video data files to any folder on your PC.

When the video data is exported, the data is exported as an image data file (filename.n3r) and an audio data file (filename.n3a). Refer to "Play back the copied/downloaded images on a PC" of the Operating Instruction on how to play exported video.

### STEP1

Click the  button.

→File advanced window will be displayed.

### STEP2

Set [Start Time & Date] and [End Time & Date], check the [Camera] you want to export, enter any folder name in the output folder or click the  button to select the output folder.

---

### Note:

- Check [All] if you want to export the videos of all cameras.
- 

### STEP3

Click the  button.

→Starts file export of the video that meets the specified condition, and displays the result when the export is completed.

## Print the displayed image

You can print images displayed in a paused state on the image display unit with the printer.





: Prints the image on pause with the date and time.

## Play the audio from the network microphone

When the audio from the network microphone is recorded in the audio data, audibility around the specified location can be improved with mouse operation on the image.

### Step 1



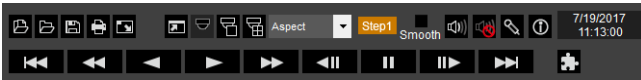

To specify a sound collecting position, click the  button. (The  button will be displayed when playback is started.)



→ The menu for setting the sound collecting position will be displayed.



### Step 2

The sound collecting position can be specified at two points at maximum. When the  and/or  button is clicked, the  and/or  icon will be displayed on the screen. Drag the icon and drop it at a desired location.

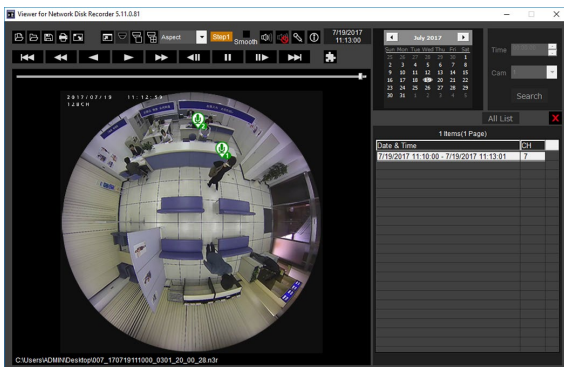

→ The audibility of the place where the icon is dropped will be improved.



- The audio noise reduction function will always be enabled if "Noise Reduction" is marked.
- Click the  button to return to the normal display.

When the fisheye images of the fisheye camera are displayed in 1-screen PTZ/4-screen PTZ with compensation, the audio from the network microphone will be output at the sound collecting position previously specified with the fisheye image. To change the position, return to the fisheye image display.

### Note:

- For video data where audio from the network microphone is not recorded, the  button will not be displayed.
- If both sound collecting positions are not specified, non-directional sound will be played.
- When "Aspect" is selected for the display format, the  button will be displayed.
- The audibility can be adjusted with the "Voice clear" setting.  
OFF: Not adjustable  
Low: Low effect  
High: High effect

**For U.S. and Canada:**

**Panasonic i-PRO Sensing Solutions Corporation of America**  
800 Gessner Rd, Suite 700 Houston, TX 77024  
<https://www.security.us.panasonic.com/>

**Panasonic Canada Inc.**  
5770 Ambler Drive, Mississauga, Ontario, L4W 2T3 Canada  
1-877-495-0580  
<https://www.panasonic.com/ca/>

**For Europe and other countries:**

**Panasonic Corporation**  
<http://www.panasonic.com>

Panasonic i-PRO Sensing Solutions Co., Ltd.  
Fukuoka, Japan

Authorised Representative in EU:

Panasonic Testing Centre  
Panasonic Marketing Europe GmbH  
Winsbergring 15, 22525 Hamburg, Germany