

## iA (intelligent Auto) H.265 Compact Dome Camera

Panasonic WV-S3532LM is a compact & simple design multifunction camera that achieves high visibility even under extreme conditions and can be placed in a small space without damaging the landscape. Intelligent Auto (iA) allows the camera to automatically adjust the key settings in real-time depending on the scenery and movement, reducing distortion such as motion blur and moving objects. New industry-leading 144dB dynamic range delivers balanced scene exposure in dynamic and extreme-backlit lighting environments. In addition, color night vision provides outstanding low-light performance with accurate color rendition and saturation from i-Pro's 1/3" sensor, rivaling the performance of costlier 1/2" sensor cameras in the market. By adopting H.265 Smart Coding technology, intelligently reduces bandwidth efficiency of up to 95%\* more than conventional H.264 for longer recording and less storage. Cameras out-of-the-box, use an encryption module standardized by FIPS Publication 140-2 for secure video streaming.

\*Value in Advanced mode with Smart Facial Coding depends on scene.

### Extreme image quality allows evidence to be captured even under challenging conditions

- Auto Shutter speed control for fast moving vehicles with Intelligent Auto
- Sharp and clear images of a walking person day & night
- Outstanding low light performance in true color with low noise for night time applications
- Super Dynamic 144dB for backlit situations involving headlights and shadows on night streets
- Built-in IR LED to produce a clear monochrome image in 0 lux conditions with 15 m (49 feet) irradiation distance
- Wide area surveillance even in compact design. moreover, corridor mode to survey vertically long area.
- Environmental durability : IP66, IK10, EN50155

### Extreme bandwidth compression with new Panasonic H.265 Smart Coding

- Longer recording and less storage compared to any H.264 based compression techniques
- New self-learning ROI\* encoding (Auto VIQS) detects movement within the image and compresses the areas with little motion in order to reduce transmitted data while maintaining the quality of the image.
- New "Smart Facial Coding" adds more bandwidth reduction for ID camera applications mainly capturing faces

\*Region of Interest

### Extreme Data Security

- Full encryption microSDXC/microSDHC/microSD card edge recording to keep your data safe
- FIPS140-2 CAVP compliant \*Using encryption module standardized by FIPS publication 140-2
- Full end-to-end system encryption with supported VMS and devices to protect from IP snooping/spoofing and detect data alteration

### Key Features

- Full HD 1080p up to 60fps
- iA (intelligent Auto)
- Extreme Super Dynamic 144dB
- Color night vision (0.0019 to 0.03 lx)
- H.265 Smart Coding
- Built-in IR LED
- Corridor mode  
(90 degrees or 270 degrees in image rotation)
- i-VMD License Bundled
- Onvif Profile G / S / T

### Industry examples

- Train
- Light rail transit
- Subway car
- Bus
- Railroad Crossing



# Specifications

<b>Camera</b>	Image Sensor	Approx. 1/3 type CMOS image sensor
	Minimum Illumination	Color : 0.03 lx, BW : 0.015 lx (F2.3, Maximum shutter : Off (1/30s), AGC : 11) BW : 0 lx (F2.3, Maximum shutter : Off (1/30 s), AGC : 11, when the IR LED is lit) Color : 0.0019 lx, BW : 0.0009 lx (F2.3, Maximum shutter : max. 16/30s, AGC : 11) *1
	White Balance	AWC (2,000 - 10,000 K), ATW1 (2,700 - 6,000 K), ATW2 (2,000 - 6,000 K)
	Maximum shutter	Max. 1/10000 s to Max. 16/30 s
	Intelligent Auto	On / Off
	Super Dynamic <sup>2</sup>	On / Off, The level can be set in the range of 0 to 31.
	Dynamic Range	Max.144 dB typ. (Super Dynamic : On)
	Adaptive Black Stretch	The level can be set in the range of 0 to 255.
	Back light compensation / High light compensation	BLC (Back light compensation) / HLC (High light compensation) / Off (only when Super dynamic / Intelligent Auto : Off)
	Fog compensation	On / Off (only when Intelligent auto / auto contrast adjust : Off)
	Maximum gain	The level can be set in the range of 0 to 11.
	Color/BW (ICR)	Off / On (IR Light Off) / On (IR Light On) / Auto1 (IR Light Off) / Auto2 (IR Light On) / Auto3 (SCC)
	IR LED Light	High / Middle / Low / Off, Maximum irradiation distance : 15 m (Approx. 49 ft)
	Digital Noise Reduction	The level can be set in the range of 0 to 255.
	Video Motion Detection (VMD)	On / Off, 4 areas available
	Intelligent VMD (i-VMD) <sup>3</sup>	Type 4 *Bundled License
	Privacy Zone	On / Off, Up to 8 zones available
	Image rotation <sup>4</sup>	0° / 90° / 180° (Upside-down) / 270°
	Mirror	On / Off
	Camera Title (OSD)	On / Off, Up to 20 characters (alphanumeric characters, marks)
Zoom Ratio	1 x Optical	
Digital (electronic) zoom	Choose from 3 levels of x1, x2, x4	
Focal length	2.8 mm (1/8 inches)	
Angular Field of View	[16 : 9 mode] Horizontal : 108° Vertical : 60° [4 : 3 mode] Horizontal : 89° Vertical : 66°	
Maximum Aperture Ratio	1 : 2.3	
Focus range	0.5 m [19-11/16 inches] - ∞	
<b>Adjusting Angle</b>	Horizontal (PAN) angle : ±45°, Vertical (TILT) angle : 0 to +90°, Azimuth (YAW) angle : ±90°	
<b>Browser GUI</b>	Camera Control	Brightness
	GUI / Setup Menu Language	English, Italian, French, German, Spanish, Portuguese, Russian, Chinese, Japanese
<b>Network</b>	Network IF	10Base-T / 100Base-TX, M12 connector
	Resolution	<b>*2 mega pixel [16 : 9] (30/60 fps)</b> 1,920 x 1,080 / 1,280 x 720 / 640 x 360 / 320 x 180 <b>*3 mega pixel [4 : 3] (30 fps)</b> 2,048 x 1,536 <sup>5</sup> / 1,280 x 960 / 800 x 600 / 640 x 480 / 400 x 300 / 320 x 240
	H.265 / H.264 JPEG (MJPEG)	Constant bit rate / VBR / Frame rate / Best effort
	H.265 / H.264 <sup>6</sup> JPEG	Unicast / Multicast
	Transmission Mode	10 steps
	Transmission Type	Smart Coding
	Image Quality	<b>GOP(Group of pictures) control</b> [When H.264 is selected] On(Mid) / On(Low) / Off [When H.265 is selected] On(Frame rate control) / On(Advanced) / On(Mid) / On(Low) / Off
	Smart Coding	<b>Smart Facial Coding*</b> Off / On(AUTO VIQS) / On(Smart Facial Coding) *Smart Facial Coding is only available with Stream(1).

<b>Network</b>	Audio Compression	G.726 (ADPCM) : 16 kbps / 32 kbps G.711 : 64 kbps AAC-LC <sup>7</sup> : 64 kbps / 96 kbps / 128 kbps
	Supported Protocol	IPv6 : TCP/IP, UDP/IP, HTTP, HTTPS, RTP, FTP, SMTP, DNS, NTP, SNMP, DHCPv6, MLD, ICMP, ARP, IEEE 802.1X, DiffServ IPv4 : TCP/IP, UDP/IP, HTTP, HTTPS, RTSP, RTP, RTP/RTCP, FTP, SMTP, DHCP, DNS, DDNS, NTP, SNMP, UPnP, IGMP, ICMP, ARP, IEEE 802.1X, DiffServ
	No. of Simultaneous Users	Up to 14 users (Depends on network conditions)
	microSDXC/microSDHC/microSD Memory Card <sup>8,9</sup>	H.265 / H.264 recording : Manual REC / Alarm REC (Pre/Post) / Schedule REC / Backup upon network failure JPEG recording : Manual REC / Alarm REC (Pre/Post) / Backup upon network failure Compatible microSDXC/microSDHC/microSD Memory Card : Panasonic 2 GB, 4 GB*, 8 GB*, 32 GB*, 64 GB**model *microSDHC card, **microSDXC card
	Mobile Terminal Compatibility	iPad, iPhone, Android™ terminals
	ONVIF Profile	G / S / T
<b>Alarm</b>	Alarm Source	VMD alarm <sup>10</sup> , Command alarm, Audio detection alarm
	Alarm Actions	microSDXC/microSDHC/microSD memory recording, E-mail notification, HTTP alarm notification Indication on browser, FTP image transfer, Panasonic alarm protocol output
<b>Input/Output</b>	Built-in microphone	Nondirectional electret condenser microphone
<b>General</b>	Safety	UL (UL60950-1 2Ed), c-UL (CAN/CSA C22. NO.60950-1-07), CE, IEC60950-1 EN45545-2 compliant, NFPA130 <sup>11</sup>
	EMC	FCC (Part15 Subpart B, ClassA, SDc), ICES-003 ClassA, EN55032 ClassB, EN55024, ECE-R10, EN50498, EN50121
	Power Source and Power Consumption	PoE (IEEE802.3af compliant, alternative A) Device : DC48 V 80 mA, Approx. 3.8 W (Class 2 device)
	Ambient Operating Temperature	-40 °C to +60 °C (-40 °F to 140 °F) <sup>12</sup> {Power On range : -20 °C to +60 °C (-4 °F to +140 °F)}
	Ambient Operating Humidity	10 to 100 % (no condensation)
	Water and Dust Resistance	IP66 (IEC60529), Type 4X(UL50), NEMA 4X compliant
	Shock Resistance	IK10 (IEC 62262)
	Railway Application	EN50155 : 2017 Class OT2/ST2 (EN 50155 : 2007 Class TX), IEC62236-3-2
	Dimensions	ø109 mm x 53 mm (H) (ø4-9/32 inches x 2-3/32 inches (H)) Dome radius 27 mm {1-1/16 inches}
	Mass (approx.)	Approx. 410 g {0.91 lbs}
	Finish	Main body : Aluminum die cast, Light gray Dome section : Polycarbonate resin, Clear

- \*1 Converted value \*2 Super Dynamic function is automatically set off on 60 fps mode.
- \*3 Smart Facial Coding, i-VMD can not be used at the same time.
- \*4 Settings of [90°] and [270°] are only available for the [16 : 9 mode].
- \*5 Used by super resolution techniques \*6 Transmission for 4K can be individually set.
- \*7 When recording audio on an microSDXC/microSDHC/microSD memory card, only use AAC-LC (Advanced Audio Coding - Low Complexity).
- \*8 The replacement cycle (target) of a microSD memory card differs from that of a standard size SD memory card. For details, check the content of the Panasonic Support website ([https://security.panasonic.com/training\\_support/support/technical\\_information/](https://security.panasonic.com/training_support/support/technical_information/)) (Control No.: C0117-),
- \*9 For details, check the content of the Panasonic Support Web Site ([https://security.panasonic.com/training\\_support/support/technical\\_information/](https://security.panasonic.com/training_support/support/technical_information/)) (Control No.: C0107-<Control No.: C0306-<Control No.: C0307->>)
- \*10 Including alarms from Plug-in Software \*11 This product satisfies this standard except for some parts.
- \*12 In the environment where IR LED is always turned on or 60 fps mode, make sure that the ambient operating temperature is between -40 °C to +50 °C (-40 °F to +122 °F).

# Appearance

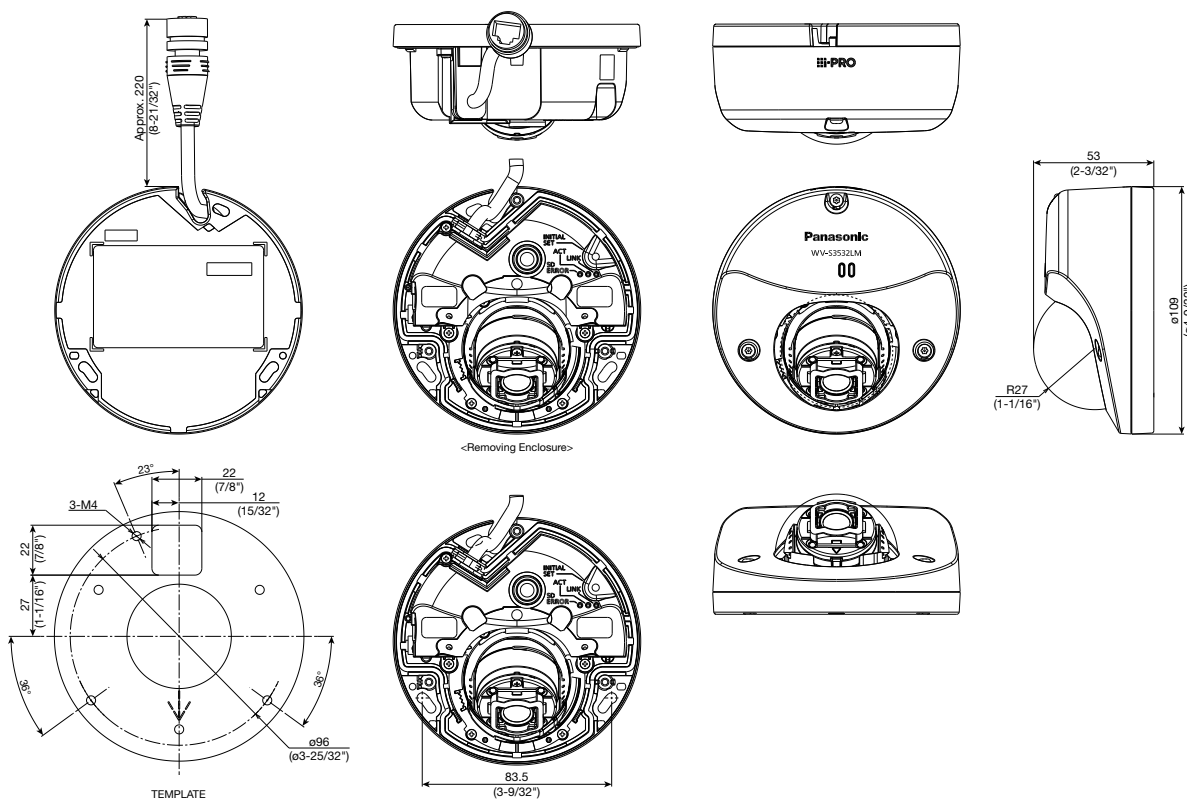

## Bundled License

### Plug-in Software for i-VMD



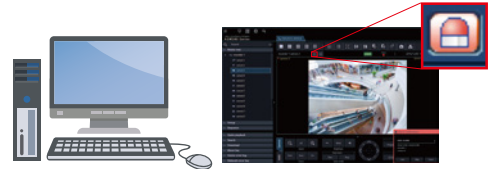



i-VMD is possible to detect objects in the specified area by advanced video analysis technology.  
 i-VMD : Intruder Detection, Loitering Detection, Direction Detection, Scene Change Detection, Object Detection, Cross Line Detection



Notification sent to the monitoring screen

## Optional Accessories

### Mount Bracket / Dome Cover / Other

<p>Base bracket <b>WV-QJB502-G</b> (Gray)</p> 	<p>Ceiling Mount Bracket <b>WV-QCL100-W</b> (i-PRO white)</p> <p>*For indoor installation only</p> 	<p>Wall Mount Bracket <b>WV-QWL500-G</b> (Gray)</p> 	<p>Adapter Box <b>WV-QJB500-G</b> (Gray)</p> <p>(This bracket requires WV-QWL500-G.)</p> 	<p>Pole Mount Bracket <b>WV-Q182</b> (Light gray)</p> <p>(This bracket requires WV-QWL500-G.)</p> 	<p>Corner Mount Bracket <b>WV-Q183</b> (Light gray)</p> <p>(This bracket requires WV-QWL500-G.)</p> 
<p>Dome Cover (Smoke type) <b>WV-CW6SA</b></p> 					

•Brackets are available in four colors, Fine silver, Light gray, Gray and i-PRO white. It is possible to use them in different color combinations.

#### Important

- Safety Precautions : Carefully read the Basic Information, Installation Guide and Operating Instructions before using this product.
- Panasonic i-PRO Sensing Solutions Co., Ltd. cannot be held responsible for the performance of the network and/or other manufacturers' products used on the network.

#### Trademarks and registered trademarks

- iPad and iPhone are trademarks of Apple Inc., registered in the U.S. and other countries.
- Android is a trademark of Google LLC.
- ONVIF is trademarks or registered trademarks of Onvif Inc.
- All other trademarks identified herein are the property of their respective owners.

• Masses and dimensions are approximate. • Specifications are subject to change without notice.

# Panasonic®

Panasonic Corporation

Panasonic i-PRO Sensing Solutions Co., Ltd.

<https://ipro.panasonic.com>

<https://security.panasonic.com>

<https://www.linkedin.com/company/i-pro-sensing-solutions-co-ltd/>

(2A-217CA)