

New U-series compact network camera with enhanced functions and affordability

Full HD Varifocal Lens Outdoor Bullet Network Camera

The new U series is an entry model that achieves high quality and reliability at an affordable price to meet the needs of a wide range of customers. The compact and slim design allows it to be installed in a various locations.

It newly supports ONVIF G / S / T profile and H.265 / H.264, and can be widely used for connecting various VMS and recorders. It also comes pre-installed with secure certificates, enabling device authentication and end-to-end communication encryption to counter the threat of advanced cyberattacks.

Key features

- Compact and slim design allows installation in various locations
- Compliant with ONVIF G / S / T profile and H.265 / H.264, and can support a wide range of connections to VMS and recorders
- Uses "Easy Kitting Packing" that allows you to set the camera without removing it from the box
- Strengthen cyber security by pre-installing digital certificates issued by a third party organization (GlobalSign)

Key i-PRO Spec.

- Full HD 1080p up to 30fps
- 2.5x built-in motorized zoom and motorized focus lens
- iA (intelligent Auto)
- Super Dynamic 120dB
- Color night vision (0.006 to 0.1 lx)
- H.265 Smart Coding
- Corridor mode
(90 degrees or 270 degrees in image rotation)
- Built-in IR LED
- ONVIF Profile G / S / T

Industry examples

- Public safety (City / Highway toll / Parking gate)
- Transportation (Airport / Train / Subway)
- Retail / Bank / Logistics / Education / Hospital / Building



Specifications

Camera	Image Sensor	Approx. 1/3 type CMOS image sensor
	Minimum Illumination	Color : 0.1 lx, BW: 0.04 lx (50IRE, F2.0, Maximum shutter: Off (1/30s), AGC: 11) BW : 0 lx (0 footcandle) (50IRE, F2.0, Maximum shutter: Off (1/30 s), AGC: 11, when the IR LED is lit) Color : 0.006 lx, BW: 0.0025 lx (50IRE, F2.0, Maximum shutter: max. 16/30s, AGC: 11) ^{*1}
	White Balance	ATW1/ ATW2/ AWC
	Maximum shutter	[30fps mode] Max. 1/10000 s to Max. 16/30 s [25fps mode] Max. 1/10000 s to Max. 16/25 s
	Intelligent Auto	On / Off
	Super Dynamic	On / Off, The level can be set in the range of 0 to 31.
	Dynamic Range	Max.120 dB (Super Dynamic: On, Level: 31)
	Adaptive Black Stretch	—
	Back light compensation / High light compensation	BLC/ HLC/ Off (only when Super Dynamic/ Intelligent auto: Off)
	Fog compensation	On / Off, The level can be set in the range of 0 to 8. (only when intelligent auto / auto contrast adjust: Off)
	Maximum gain (AGC)	The level can be set in the range of 0 to 11.
	Color/BW (ICR)	Off/ On (IR Light Off) / On (IR Light On) / Auto1 (IR Light Off) / Auto2 (IR Light On) / Auto3 (SCC)
	IR LED Light	High/ Middle/ Low/ Off Maximum irradiation distance: 30 m (Approx. 100 ft)
	Digital Noise Reduction	The level can be set in the range of 0 to 255.
	Video Motion Detection (VMD)	On / Off, 4 areas available
	Scene Change Detection(SCD)	On / Off, 1 area available
	Privacy Zone	On / Off, Up to 8 zones available
	Image rotation ^{*2}	0° (Off) / 90° / 180° (Upside-down) / 270°
	Camera Title (OSD)	On / Off, Up to 20 characters (alphanumeric characters, marks)
	Lens	Focal length
Optical zoom		2.5x (Motorized zoom / Motorized focus)
Extra optical zoom		2.5x - 3.8x (when resolution is 1280x720)
Digital (electronic) zoom		Choose from 3 levels of x1, x2, x4
Angular Field of View		[16 : 9 mode] Horizontal : 44° (TELE) - 102° (WIDE), Vertical : 24° (TELE) - 56° (WIDE) [4 : 3 mode] Horizontal : 36° (TELE) - 84° (WIDE), Vertical : 27° (TELE) - 63° (WIDE)
DORI	Detect (25ppm / 8ppf)	Wide: 35.5 m / 116.6 ft, Tele: 98.5 m / 323.1 ft
	Observe (62.5ppm / 19ppf)	Wide: 14.2 m / 46.6 ft, Tele: 39.4 m / 129.2 ft
	Recognize (125ppm / 38ppf)	Wide: 7.1 m / 23.3 ft, Tele: 19.7 m / 64.6 ft
	Identify (250ppm / 76ppf)	Wide: 3.6 m / 11.7 ft, Tele: 9.8 m / 32.3 ft
Adjusting Angle	Ceiling mounting	Horizontal: ±180° (Adjust by horizontal (PAN) angle) Vertical : 0° to 100° (Adjust by vertical (TILT) angle) Yaw : -190° to +100° (Adjust by azimuth (YAW) angle)
	Wall mounting	Horizontal: ±100° (Adjust by vertical (TILT) angle)* Vertical : ±100° (Adjust by vertical (TILT) angle)* Yaw : -190° to +100° (Adjust by azimuth (YAW) angle) *You can change between horizontal and vertical angles by adjusting the horizontal (PAN) angle.
Browser GUI	Camera Control	Brightness
	GUI /	English, Italian, French, German, Spanish, Portuguese, Russian,
	Setup Menu Language	Chinese, Japanese

*1 Converted value

*2 When "4:3(30fps mode)" or "4:3(25fps mode)" is selected for "Image capture mode", "90°" and "270°" cannot be selected.

Network	Network IF	10Base-T / 100Base-TX, RJ45 connector					
	Resolution	[16 : 9 mode] 1920x1080, 1280x720, 640x360, 320x180 [4 : 3 mode] 1600x1200, 1280x960, VGA, QVGA					
	H.265/ H.264	Transmission Mode Constant bit rate / VBR / Frame rate / Best effort					
	H.264	Transmission Type	Unicast / Multicast				
		Max. frame rate for each stream ^{*3}	Stream(1)	Stream(2)	Stream(3)	JPEG(1)	JPEG(2)
			1920x1080(30fps)	640x360(30fps)	Off	1920x1080(1fps)	1280x720(1fps)
			1280x720(30fps)	1280x720(30fps)	Off	1920x1080(1fps)	1280x720(1fps)
	1600x1200(30fps)	640x480(30fps)	Off	1600x1200(1fps)	1280x960(1fps)		
	JPEG	Image Quality	10 steps				
	Smart Coding	GOP(Group of pictures) control: On(Frame rate control) / On(Advanced) / On(Mid) / On(Low) / Off *Frame rate control and Advanced are only available with H.265. AUTO VIQS: On/ Off					
	Audio Compression	—					
	Audio transmission mode	—					
	Supported Protocol	IPv6 : TCP/IP, UDP/IP, HTTP, HTTPS, SSL/TLS, SMTP, DNS, NTP, SNMPv1/v2/v3, DHCPv6, RTP, MLD, ICMP, ARP, IEEE 802.1X, DiffServ IPv4 : TCP/IP, UDP/IP, HTTP, HTTPS, SSL/TLS, RTSP, RTP, RTSP/RTCP, SMTP, DHCP, DNS, DDNS, NTP, SNMPv1/v2/v3, UPnP, ICMP, ARP, IEEE 802.1X, DiffServ					
	No. of Simultaneous Users	Up to 14 users (Depends on network conditions)					
	SDXC/SDHC/SD Memory Card (Option)	H.265/H.264 recording: Manual REC / Alarm REC (Pre/Post) / Schedule REC Available SDXC/SDHC/SD Memory Card : microSDXC memory card: 64 GB, 128 GB, 256 GB, 512 GB microSDHC memory card: 4 GB, 8 GB, 16 GB, 32 GB microSD memory card: 2 GB					
Mobile Terminal Compatibility	iPad, iPhone, Android™ terminals						
ONVIF Profile	G / S / T						
Alarm	Alarm Source	VMD alarm, SCD alarm, Command alarm					
	Alarm Actions	SDXC/SDHC/SD memory recording, E-mail notification, HTTP alarm notification Indication on browser, Panasonic alarm protocol output					
Input/ Output	Monitor Output(for adjustment)	—					
	Audio input	—					
	Audio Output	—					
	External I/O Terminals	—					
General	Safety	UL (UL60950-1), c-UL (CSA C22.2 No.60950-1), CE, IEC60950-1					
	EMC	FCC (Part15 ClassA), ICES003 ClassA, EN55032 ClassB, EN55024					
	Power Source and Power Consumption	PoE (IEEE802.3af compliant) Device: DC48 V 140 mA, Approx. 6.7 W (Class 0 device)					
	Ambient Operating Temperature	-30 °C to +50 °C (-22 °F to +122 °F)					
	Temperature	{Power On range: -20 °C to +50 °C (-4 °F to +122 °F)}					
	Ambient Operating Humidity	10 to 100 % (no condensation)					
	Anti-Condensation System	Temish element					
	Water and Dust Resistance ^{*4}	IP66 (IEC 60529), Type 4X (UL50E), NEMA 4X compliant					
	Shock Resistance	IK10 (IEC 62262)					
	Dimensions	112.5 mm (W) x 112.5 mm (H) x 262 mm (D) {4-7/16 inches(W) x 4-7/16 inches(H) x 10-5/16 inches(D)}					
	Mass (approx.)	860 g {1.90 lbs.}					
	Finish	Main body: Aluminum die cast/ PC resin, I-PRO white Outer fixing screws: Stainless steel (Corrosion-resistant treatment) Front cover: Polycarbonate resin, Clear					

*3 Smart Coding(GOP and AUTO VIQS) is not available when setting 30fps.

*4 Only when installation work is properly performed according to the Installation Guide and appropriate waterproof treatment is performed.

Appearance



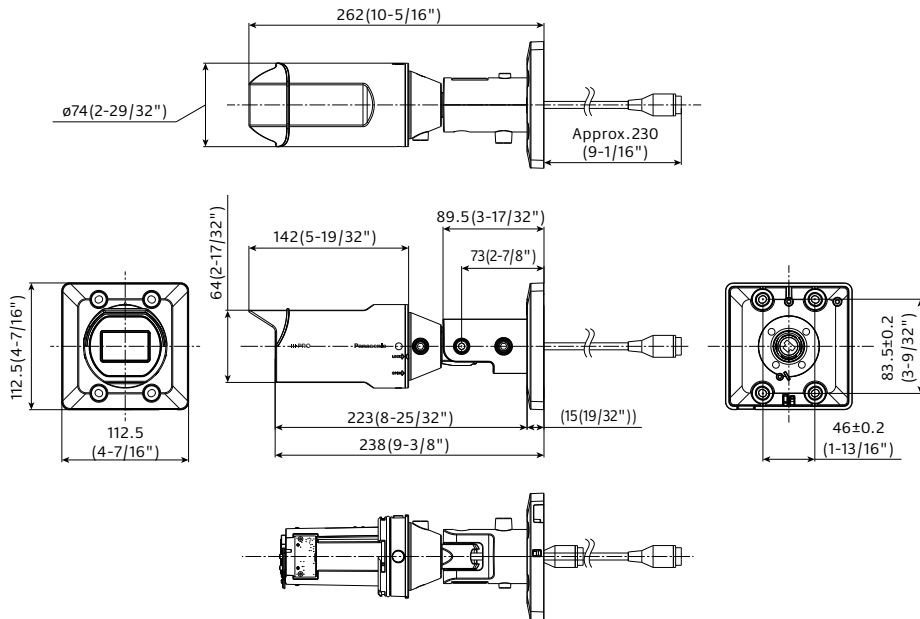



Unit : mm (inches)



Without front cover

Optional Accessories

Mount Bracket / Other

	WALL/CEILING	POLE	CORNER	HANGING
combination	1 Adapter Box WV-QJB500-W (i-PRO white)  *If needed.	1 Pole Mount Bracket WV-QPL500-W (i-PRO white) 	1 Corner Mount Bracket WV-QCN500-W (i-PRO white) 	1 Ceiling Mount Bracket WV-QCL100-W ^{*1} (i-PRO white)  *For indoor installation only.
		Adapter Box WV-QJB500-W (i-PRO white)  *If needed.	Adapter Box WV-QJB500-W (i-PRO white)  *If needed.	3rd Parties Pipe

*1 : It's possible to be used on the camera side and ceiling side. If used on both side, 2pieces are required.

Trademarks and registered trademarks

- iPad and iPhone are trademarks of Apple Inc., registered in the U.S. and other countries.
- Android is a trademark of Google LLC.
- ONVIF is trademarks or registered trademarks of Onvif Inc.
- All other trademarks identified herein are the property of their respective owners.

Important

- Safety Precautions : Carefully read the Basic Information, Installation Guide and Operating Instructions before using this product.
- Panasonic i-PRO Sensing Solutions Co., Ltd. cannot be held responsible for the performance of the network and/or other manufacturers' products used on the network.

• Masses and dimensions are approximate. • Specifications are subject to change without notice.

Panasonic®

Panasonic Corporation

Panasonic i-PRO Sensing Solutions Co., Ltd.

<https://ipro.panasonic.com>

<https://security.panasonic.com>

<https://www.linkedin.com/company/i-pro-sensing-solutions-co-ltd/>

(2A-290A)