

New U-series compact network camera with enhanced functions and affordability

4MP Varifocal Lens Outdoor Dome Network Camera

The new U series is an entry model that achieves high quality and reliability at an affordable price to meet the needs of a wide range of customers. The compact and slim design allows it to be installed in a various locations.

It newly supports ONVIF G / S / T profile and H.265 / H.264, and can be widely used for connecting various VMS and recorders. It also comes pre-installed with secure certificates, enabling device authentication and end-to-end communication encryption to counter the threat of advanced cyberattacks.

Key features

- Compact and slim design allows installation in various locations
- Compliant with ONVIF G / S / T profile and H.265 / H.264, and can support a wide range of connections to VMS and recorders
- Uses "Easy Kitting Packing" that allows you to set the camera without removing it from the box
- Strengthen cyber security by pre-installing digital certificates issued by a third party organization (GlobalSign)

Key i-PRO Spec.

- 5MP Sensor
- 2688×1520 pixel image up to 30fps
- 2.5x built-in motorized zoom and motorized focus lens
- iA (intelligent Auto)
- Super Dynamic 102dB
- Color night vision (0.019 to 0.3 lx)
- H.265 Smart Coding
- Corridor mode
(90 degrees or 270 degrees in image rotation)
- Built-in IR LED
- ONVIF Profile G / S / T

Industry examples

- Safe Cities
- Transportation (Airport / Train, Subway station)
- Bank (ATM, Entrance)
- Retail / Logistics / Education / Hospital / Building



Specifications

Camera	Image Sensor	Approx. 1/2.7 type CMOS image sensor
	Minimum Illumination	Color : 0.3 lx, BW: 0.12 lx (50IRE, F2.0, Maximum shutter: Off (1/30s), AGC: 11) BW : 0 lx (0 footcandle) (50IRE, F2.0, Maximum shutter: Off (1/30 s), AGC: 11, when the IR LED is lit) Color : 0.019 lx, BW: 0.0075 lx (50IRE, F2.0, Maximum shutter: max. 16/30s, AGC: 11) *1
	White Balance	ATW1/ ATW2/ AWC
	Maximum shutter	[30fps mode] Max. 1/10000 s to Max. 16/30 s [25fps mode] Max. 1/10000 s to Max. 16/25 s
	Intelligent Auto	On / Off
	Super Dynamic	On / Off, The level can be set in the range of 0 to 31.
	Dynamic Range	Max.102 dB (Super Dynamic: On, Level: 31)
	Adaptive Black Stretch	—
	Back light compensation / High light compensation	BLC/ HLC/ Off (only when Super Dynamic/ Intelligent auto: Off)
	Fog compensation	On / Off, The level can be set in the range of 0 to 8. (only when Intelligent auto / auto contrast adjust: Off)
	Maximum gain (AGC)	The level can be set in the range of 0 to 11.
	Color/BW (ICR)	Off/ On (IR Light Off) / On (IR Light On) / Auto1 (IR Light Off) / Auto2 (IR Light On) / Auto3 (SCC)
	IR LED Light	High/ Middle/ Low/ Off Maximum irradiation distance: 20 m (Approx. 65 ft)
	Digital Noise Reduction	The level can be set in the range of 0 to 255.
	Video Motion Detection (VMD)	On / Off, 4 areas available
	Scene Change Detection (SCD)	On / Off, 1 areas available
	Privacy Zone	On / Off, Up to 8 zones available
Image rotation	0° (Off) / 90° / 180° (Upside-down) / 270°	
Camera Title (OSD)	On / Off, Up to 20 characters (alphanumeric characters, marks)	
Lens	Focal length	2.9 mm - 7.3 mm (1/8inches-9/32inches)
	Optical zoom	2.5x (Motorized zoom / Motorized focus)
	Extra optical zoom	2.5x - 3.3x (when resolution is 1920x1080)
	Digital (electronic) zoom	Choose from 3 levels of x1, x2, x4
	Angular Field of View	[16 : 9 mode] * [4:3 mode] is not supported. Horizontal : 43° (TELE) - 100° (WIDE), Vertical : 24° (TELE) - 56° (WIDE)
DORI	Detect (25ppm / 8ppf)	Wide: 43.0 m / 141.0 ft, Tele: 130.0 m / 426.4 ft
	Observe (62.5ppm / 19ppf)	Wide: 17.2 m / 56.4 ft, Tele: 52.0 m / 170.6 ft
	Recognize (125ppm / 38ppf)	Wide: 8.6 m / 28.2 ft, Tele: 26.0 m / 85.3 ft
	Identify (250ppm / 76ppf)	Wide: 4.3 m / 14.1 ft, Tele: 13.0 m / 42.6 ft
Adjusting Angle	Ceiling mounting	—
	Wall mounting	—
Browser	Camera Control	Brightness
GUI	GUI / Setup Menu Language	English, Italian, French, German, Spanish, Portuguese, Russian, Chinese, Japanese

*1 Converted value

*2 Smart Coding (GOP and AUTO VIQS) is not available when setting 30fps.

*3 Only when installation work is properly performed according to the Installation Guide and appropriate waterproof treatment is performed.

Network	Network IF	10Base-T / 100Base-TX, RJ45 connector						
	Resolution H.265/H.264	[16:9 mode(2688x1520 30fps mode)], [16:9 mode(2688x1520 25fps mode)] 2688x1520, 1920x1080, 640x360, 320x180 [16:9 mode(30fps mode)], [16:9 mode(25fps mode)] 2560x1440, 1920x1080, 640x360, 320x180 *[4:3 mode] is not supported.						
	H.265 / H.264	Transmission Mode	Constant bit rate / VBR / Frame rate / Best effort					
		Transmission Type	Unicast / Multicast					
	JPEG	Image Quality	Max. frame rate for each stream*2	Stream(1) 2688x1520(30fps) 2560x1440(30fps) 1920x1080(30fps)	Stream(2) Off 640x360(30fps) 1920x1080(30fps)	Stream(3) Off Off 640x360(10fps)	JPEG(1) 2560x1440(1fps) 1920x1080(1fps)	JPEG(2) 1920x1080(1fps) 1920x1080(1fps)
			Smart Coding	GOP(Group of pictures) control: On(Frame rate control) / On(Advanced) / On(Mid) / On(Low) / Off *Frame rate control and Advanced are only available with H.265. AUTO VIQS: On/ Off				
	Audio Compression		—					
	Audio transmission mode		—					
	Supported Protocol		IPv6 : TCP/IP, UDP/IP, HTTP, HTTPS, SSL/TLS, SMTP, DNS, NTP, SNMPv1/v2/v3, DHCPv6, RTP, MLD, ICMP, ARP, IEEE 802.1X, DiffServ IPv4 : TCP/IP, UDP/IP, HTTP, HTTPS, SSL/TLS, RTSP, RTP, RTP/RTCP, SMTP, DHCP, DNS, DDNS, NTP, SNMPv1/v2/v3, UPnP, IGMP, ICMP, ARP, IEEE 802.1X, DiffServ					
	No. of Simultaneous Users		Up to 14 users (Depends on network conditions)					
SDXC/SDHC/SD Memory Card (Option)		H.265/H.264 recording: Manual REC / Alarm REC (Pre/Post) / Schedule REC Available SDXC/SDHC/SD Memory Card : microSDXC memory card: 64 GB, 128 GB, 256 GB, 512 GB microSDHC memory card: 4 GB, 8 GB, 16 GB, 32 GB microSD memory card: 2 GB						
Mobile Terminal Compatibility		iPad, iPhone, Android™ terminals						
ONVIF Profile		G / S / T						
Alarm	Alarm Source	VMD alarm, SCD alarm, Command alarm						
	Alarm Actions	SDXC/SDHC/SD memory recording, E-mail notification, HTTP alarm notification Indication on browser, Panasonic alarm protocol output						
Input/Output	Monitor Output(for adjustment)	—						
	Audio input/Audio Output External I/O Terminals	—						
General	Safety	UL (UL60950-1), c-UL (CSA C22.2 No.60950-1), CE, IEC60950-1						
	EMC	FCC (Part15 ClassA), ICES003 ClassA, EN55032 ClassB, EN55024						
	Power Source and Power Consumption	PoE (IEEE802.3af compliant) Device: DC48 V 150 mA, Approx. 7.2 W (Class 0 device)						
	Ambient Operating Temperature	-30 °C to +50 °C (-22 °F to +122 °F) {Power On range: -20 °C to +50 °C (-4° F to +122 °F)}						
	Ambient Operating Humidity	10 to 100 % (no condensation)						
	Anti-Condensation System	Temish element						
	Water and Dust Resistance*3	IP66 (IEC 60529), Type 4X (UL50E), NEMA 4X compliant						
	Shock Resistance	IK10 (IEC 62262)						
	Dimensions	ø154 mm (W) x 103 mm (H) (ø6-1/16 inches x 4-1/16 inches (H)) Dome radius 42 mm (1-21/32 inches)						
	Mass (approx.)	1.0 kg {2.21 lbs.}						
	Finish	Main body: Aluminum die cast/ PC resin, i-PRO white Outer fixing screws: Stainless steel (Corrosion-resistant treatment) Dome cover: Polycarbonate resin, Clear						

Appearance

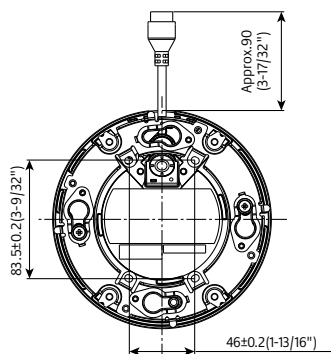
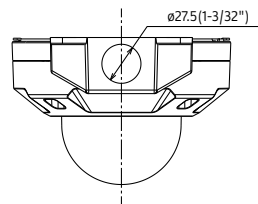
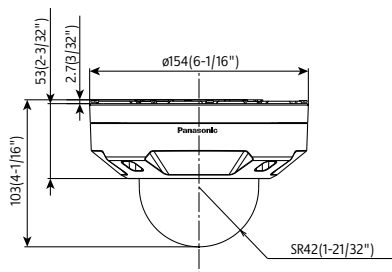

With Attachment plate

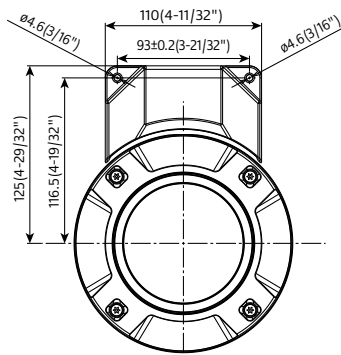



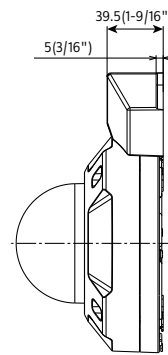









With Attachment for the conduit













Unit : mm (inches)

Optional Accessories

Mount Bracket / Other

combination	WALL			POLE		CORNER	
	1	2	3	1	2	1	2
	Wall Mount Bracket PWM485W (White) 	Wall Mount Bracket WV-QWL500-W (White) 	Sun Shade WV-QSR500-W (White) 	Pole Mount Bracket PAPM4W (White) 		Corner Mount Bracket PACA4W (White) 	
	Conduit Adapter PAPM6 (Black) 	Adapter Box WV-QJB500-W (White) 	Base Bracket WV-QJB501-W (White) 	Wall Mount Bracket PWM485W (White) 	Wall Mount Bracket WV-QWL500-W (White) (+ WV-QJB500-W) 	Wall Mount Bracket PWM485W (White) 	Wall Mount Bracket WV-QWL500-W (White) (+ WV-QJB500-W) 

*If needed.

combination	HANGING			PARAPET	CEILING		
	1	2	3	1	1	2	3
	Ceiling Mount Bracket WV-QCL501-W (White) 	Ceiling Mount Bracket WV-QCL101-W (White) 	Ceiling Mount Bracket WV-QCL101-W *1 (White) 	Parapet Mount Bracket PPRM35W (White) 	Ceiling Mount Bracket (Embedded) WV-QEM500-W (White) 	Base Bracket WV-QJB501-W (White) 	Ceiling Mount Bracket WV-Q105A 
	Mount Bracket WV-QSR501-W (White) 	Mount Bracket PS485W (White) 	This bracket requires 1 1/2" NPT pipe.	Mount Bracket PS485W (White) 			

*1: It's possible to be used on the camera side and ceiling side. If used on both side, 2pieces are required.

Dome Cover

Dome Cover (Smoke type) WV-CW7S 	Dome Cover (Smoke type with ClearSight coating) WV-CW7SN 	Dome Cover (Clear type with ClearSight coating) WV-CW7CN 
-------------------------------------------------------------------------------------------------------------------------------------	--------------------------------------------------------------------------------------------------------------------------------------------------------------	--------------------------------------------------------------------------------------------------------------------------------------------------------------

Trademarks and registered trademarks

- iPad and iPhone are trademarks of Apple Inc., registered in the U.S. and other countries.
- Android is a trademark of Google LLC.
- ONVIF is trademarks or registered trademarks of Onvif Inc.
- All other trademarks identified herein are the property of their respective owners.

Important

- Safety Precautions : Carefully read the Basic Information, Installation Guide and Operating Instructions before using this product.
- Panasonic i-PRO Sensing Solutions Co., Ltd. cannot be held responsible for the performance of the network and/or other manufacturers' products used on the network.

• Masses and dimensions are approximate. • Specifications are subject to change without notice.

Panasonic®

Panasonic Corporation

Panasonic i-PRO Sensing Solutions Co., Ltd.

<https://ipro.panasonic.com>

<https://security.panasonic.com>

<https://www.linkedin.com/company/i-pro-sensing-solutions-co-ltd/>

(2A-299L)