

## The new Standard by i-PRO video surveillance

# 2MP (1080p) Vandal Resistant Outdoor Dome Network Camera

The S-Series network cameras offer a new standard in i-PRO video surveillance with drastically improved image quality with advanced technology. It comes with pre-installed AI analytics applications that detects people and vehicles with accuracy, allowing you to easily start state-of-the-art video surveillance.

The camera can be configured while keeping the unit in the box with the acclaimed "Easy Kitting Packaging", making the installation process smooth and easy.

### Key Features

- Drastically improved image quality by advanced technology and AI intelligent Auto
- Pre-installed AI analytics applications to detect human and vehicles. Ready for installing 3<sup>rd</sup> party applications
- Detecting suspicious sound like Gunshot, Yell, Vehicle horn, and Glass break, with external microphones
- Easy Kitting Package enabling installers to configure cameras easily while keeping the unit in the box
- i-PRO Configuration Tool "iCT" can set up 1024 cameras at the same time.

( iCT page : [https://security.panasonic.com/training\\_support/design\\_tools/iCT/](https://security.panasonic.com/training_support/design_tools/iCT/) )

### Key i-PRO Spec.

- 2MP (1080p)
- Intelligent Auto (with AI Engine)
- Super Dynamic 144dB
- Color night vision (0.011 to 0.015 lx)
- Smart Coding (with AI Engine)
- ClearSight Coating
- Built-in IR LED
- Onvif Profile G / S / T

### Industry examples

- Safe Cities
- Transportation (Airport / Train, Subway station)
- Bank (ATM, Entrance)
- Retail / Logistics / Education / Hospital / Building



# i-PRO

# Specifications

<b>Camera</b>	Image Sensor	Approx. 1/2.8 type CMOS image sensor
	Minimum Illumination	Color : 0.01 lx (30IRE, F1.7, 1/30s) <sup>*1</sup> Color : 0.015 lx (50IRE, F1.7, 1/30s) BW : 0.008 lx (50IRE, F1.7, 1/30s) BW : 0 lx (50IRE, F1.7, 1/30s with IR LED)
	White Balance	ATW1 / ATW2 / AWC
	Shutter Speed	[60 fps Mode] 1/60 Fix to 1/10000 Fix, [30 fps/15 fps mode] 1/30 Fix to 1/10000 Fix [50 fps Mode] 1/50 Fix to 1/10000 Fix, [25 fps/12.5 fps mode] 1/25 Fix to 1/10000 Fix
	Intelligent Auto	On / Off
	Super Dynamic <sup>*2</sup>	On / Off. The level can be set in the range of 0 to 31.
	Dynamic Range	Max.144 dB (Super Dynamic : On, Level 31)
	Adaptive Black Stretch	The level can be set in the range of 0 to 255.
	Back light compensation / High light compensation	BLC (Back light compensation) / HLC (High light compensation) / Off (only when Super dynamic / Intelligent Auto : Off)
	Fog compensation	On / Off (only when Intelligent auto / auto contrast adjust : Off)
	Maximum gain (AGC)	The level can be set in the range of 0 to 11.
	Color/BW (ICR)	Off / On (IR Light Off) / On (IR Light On) / Auto1 (IR Light Off) / Auto2 (IR Light On) / Auto3 (SCC)
	IR LED Light	High / Middle / Low / Off, Maximum irradiation distance : 70 m (Approx. 230 ft) (30IRE) <sup>*1</sup> 50 m (Approx. 164 ft) (50IRE)
	Digital Noise Reduction	The level can be set in the range of 0 to 255.
	Video Motion Detection (VMD)	On / Off, 4 areas available
	Scene Change Detection (SCD)	On / Off, 1 areas available
	Audio Detection	On / Off
	AI Sound Classification	Gunshot, Yell, Vehicle horn, Glass break
	AI Analytics	Yes
	Privacy Zone	On / Off. Up to 8 zones available
VIQS	On / Off. Up to 8 zones available	
Image rotation <sup>*3</sup>	0° / 90° / 180° / 270°	
Camera Title (OSD)	On / Off. Up to 40 characters (alphanumeric characters, marks)	
Focus Adjustment	Auto focus	
<b>Lens</b>	Optical zoom	2.3x (Motorized zoom / Motorized Focus)
	Extra zoom	2.3x - 6.9x (when resolution is 640 x 360)
	Focal length	9 - 21 mm (11/32 inches - 13/16 inches)
	Angular Field of View	[ 16 : 9 mode] Horizontal : 15° (TELE) - 36° (WIDE), Vertical : 9° (TELE) - 20° (WIDE) [ 4 : 3 mode] Horizontal : 11° (TELE) - 27° (WIDE), Vertical : 9° (TELE) - 20° (WIDE)
	Maximum Aperture Ratio	1 : 1.7 (WIDE) - 1 : 3.0 (TELE)
Focus Range	2 m (78-3/4 inches) - ∞	
<b>DORI</b>	Detect (25ppm / 8ppf)	Wide: 118.2 m / 387.7 ft, Tele: 291.7 m / 956.9 ft
	Observe (62.5ppm / 19ppf)	Wide: 47.3 m / 155.1 ft, Tele: 116.7 m / 382.8 ft
	Recognize (125ppm / 38ppf)	Wide: 23.6 m / 77.5 ft, Tele: 58.3 m / 191.4 ft
	Identify (250ppm / 76ppf)	Wide: 11.8 m / 38.8 ft, Tele: 29.2 m / 95.7 ft
<b>Adjusting Angle</b>	Horizontal : -194 to +166°, Vertical : -30 to +85°, Yaw : ±100°	
<b>Browser GUI</b>	Camera Control	Brightness, AUX On / Off
	Audio	Mic (Line) Input : On / Off Volume adjustment : Low / Middle / High Audio Output : On / Off Volume adjustment : Low / Middle / High
	GUI / Setup Menu Language	English, Italian, French, German, Spanish, Portuguese, Russian, Chinese, Japanese
	Browser <sup>*4</sup>	Microsoft Edge, Firefox, Google Chrome
<b>Network</b>	Network IF	10Base-T / 100Base-TX, RJ45 connector
	Resolution	[ 16 : 9 mode (60 fps mode) ] <sup>*2</sup> , [ 16 : 9 mode (30 fps mode) ], [ 16 : 9 mode (50 fps mode) ] <sup>*2</sup> , [ 16 : 9 mode (25 fps mode) ] 1920x1080, 1280x720, 640x360, 320x180
		[ 4 : 3 mode (30 fps mode) ], [ 4 : 3 mode (25 fps mode) ] 1280x960, VGA, QVGA
		[ 4 : 3 mode (15 fps mode) ], [ 4 : 3 mode (12.5 fps mode) ] 2048x1536 <sup>*5</sup> , 1280x960, VGA, QVGA
	H.265 / H.264 <sup>*6</sup>	Transmission Mode Constant bit rate / VBR / Frame rate / Best effort
	JPEG	Transmission Type Unicast port (AUTO) / Unicast port (MANUAL) / Multicast Image Quality 10 steps

<b>Network</b>	Smart Coding	<b>GOP (Group of pictures control):</b> Off / Low (Variable GOP 1s-8s) / Mid (Variable GOP 4s-16s) / Advanced (Fixed GOP 60s w/1s key-frame) / Frame rate control (Variable GOP 4s-16s with frame rate control) <sup>*4</sup> Advanced and Frame rate control are only available with H.265. <b>Smart VIQS:</b> On(High) / On(Low) / Off. <b>Smart P-picture control:</b> On / Off
	Audio Compression	G.726 (ADPCM) : 16 kbps / 32 kbps G.711 : 64 kbps AAC-LC <sup>*7</sup> : 64 kbps / 96 kbps / 128 kbps
	Audio transmission mode	Off / Mic (Line) input / Audio output / Interactive (Half duplex) / Interactive (Full duplex)
	Supported Protocol	IPv6 : TCP/IP, UDP/IP, HTTP, HTTPS, SSL/TLS, SMTP, DNS, NTP, SNMPv1/v2/v3, DHCPv6, RTP, MLD, ICMP, ARP, IEEE 802.1X, DiffServ IPv4 : TCP/IP, UDP/IP, HTTP, HTTPS, SSL/TLS, RTSP, RTP, RTCP, RTCP, SMTP, DHCP, DNS, DDNS, NTP, SNMPv1/v2/v3, UPnP, IGMP, ICMP, ARP, IEEE 802.1X, DiffServ, SRTP
	No. of Simultaneous Users	Up to 14 users (Depends on network conditions)
	SDXC/SDHC/SD Memory Card (Option)	H.265 / H.264 recording : Manual REC / Alarm REC (Pre/Post) / Schedule REC / Backup upon network failure JPEG recording : Manual REC / Alarm REC (Pre/Post) / Backup upon network failure Available SDXC/SDHC/SD Memory Card : microSDXC memory card : 64 GB, 128 GB, 256 GB, 512 GB microSDHC memory card : 4 GB, 8 GB, 16 GB, 32 GB microSD memory card : 2 GB
	Mobile Terminal Compatibility	iPad, iPhone, Android™ terminals
	ONVIF Profile	G / S / T
	Alarm Source	3 terminals input, VMD alarm, Command alarm, Audio detection alarm
	Alarm Actions	SDXC/SDHC/SD memory recording, E-mail notification, HTTP alarm notification/Indication on browser, Panasonic alarm protocol output
<b>Input/ Output</b>	Monitor Output (for adjustment)	VBS : 1.0 V [p-p] / 75 Ω, composite, Pin jack An NTSC or PAL signal can be outputted from camera
	Audio input <sup>*8</sup>	ø3.5 mm stereo mini jack For microphone input : Recommended applicable microphone : Plug-in power type (Sensitivity of microphone : -48 dB±3 dB (0 dB=1 V/Pa, 1 kHz)) Input impedance : Approx. 2 kΩ (unbalanced) Supply voltage : 2.5 V ±0.5 V
	For line input :	Input level : Approx. -10 dBV
	Audio Output <sup>*8</sup>	ø3.5 mm stereo mini jack (monaural output) Output impedance : Approx. 600 Ω (unbalanced) Output level : -20 dBV
External I/O Terminals <sup>*8</sup>	ALARM IN 1 (Alarm input 1) Black & white input/ Auto time adjustment input (x1) ALARM IN 2 (Alarm input 2) ALARM OUT (x1), ALARM IN 3 (Alarm input 3) AUX OUT (x1)	
<b>General</b>	Safety	UL (UL62368-1), c-UL (CSA C22.2 No. 62368-1), CE, IEC62368-1
	EMC	FCC (Part15 ClassA), ICES-003 ClassA, EN55032 ClassB, EN55035
	Power Source and Power Consumption	DC power supply <sup>*8</sup> : DC12 V 860 mA, Approx. 10.3 W PoE (IEEE802.3af compliant) Device : DC48 V 210 mA, Approx. 10.1 W (Class 0 device)
	Ambient Operating Temperature	-40 °C to +60 °C (-40 °F to 140 °F) <sup>9</sup> (Power On range : -30 °C to +60 °C (-22 °F to +140 °F))
	Ambient Operating Humidity	10 to 100 % (no condensation)
	Anti-Condensation System	Temish element + Heater + moisture absorption gel
	Water and Dust Resistance	IP66, IEC60529 measuring standard compatible, Type 4X(UL50E), NEMA 4X compliant
	Shock Resistance	50J (IEC 60068-2-75 compliant), 1K10 (IEC 62262)
	Dimensions	ø154 mm x 105 mm (H) [ø6-1/16 inches x 4-1/8 inches (H)]
	Mass (approx.)	Approx. 1.1 kg [2.43 lbs.]
Finish	Main body : Aluminum die cast and resin, i-PRO white Outer fixing screws : Stainless steel (Corrosion-resistant treatment) Dome section : Polycarbonate resin, Clear (with ClearSight coating)	

<sup>\*1</sup> Converted value  
<sup>\*2</sup> When 60 fps or 50 fps is selected, the Super Dynamic function is automatically set to off.  
<sup>\*3</sup> When the 60 fps mode, 50 fps mode, 15 fps mode or 12.5 fps mode is used, the "90°" and "270°" settings are not available. When the 320x180 resolution is used, the "90°" and "270°" settings are not available.  
<sup>\*4</sup> For information on the operation verification of the supported web browsers, refer to our support website <Control No.: C013>.  
<sup>\*5</sup> Used by super resolution techniques  
<sup>\*6</sup> Transmission for 4 streams can be individually set.  
<sup>\*7</sup> When recording audio on an microSD memory card, only use AAC-LC (Advanced Audio Coding - Low Complexity).  
<sup>\*8</sup> When using with these, WW-QCA501A cable is required.  
<sup>\*9</sup> When using with the IR LED light constantly lit, the upper limit of the operating temperature range is +50 °C (+122 °F).

# Appearance

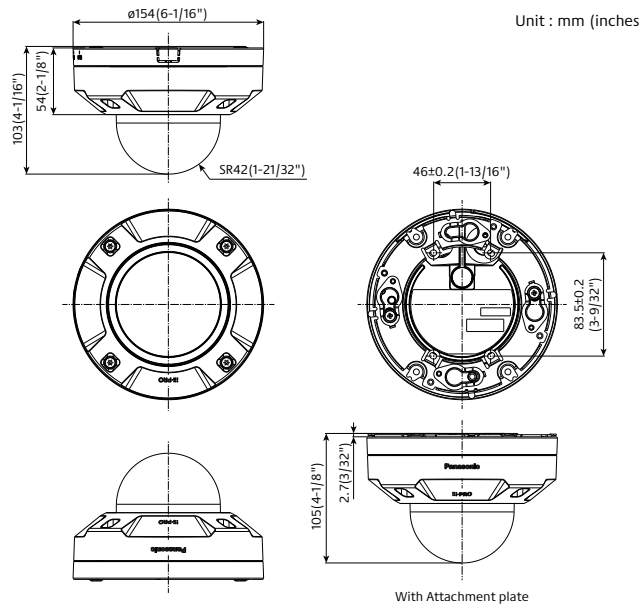

# AI Analytics applications

[https://security.panasonic.com/products\\_technology/products/i-pro\\_ai\\_application/](https://security.panasonic.com/products_technology/products/i-pro_ai_application/)

**AI Video Motion Detection (AI-VMD)**  
 Advanced video analysis technology detects objects (faces, people, cars, motorcycles) in a specified area. (Intruder Detection, Loitering Detection, Direction Detection, Cross Line Detection)

**AI Privacy Guard**  
 To protect privacy and portrait rights, it is possible to automatically apply a mosaic the entire face and figure of a person photographed by the camera.

**AI Face Detection**  
 Detects faces with high precision even in low-light, backlit, and mask-wearing environments.

**AI People Detection**  
 Extract the characteristics of human face / clothing and classify them into meaningful categories such as gender, age, and clothing color.

**AI Vehicle Detection**  
 Extract vehicle characteristics and classify them into meaningful categories such as type and color.













**AI Non mask Detection**  
 Deep-learning and proprietary image processing technologies recognize mask and detect people who are not wearing them.











**AI Occupancy Detection**  
 Detecting the congestion via network camera with AI engine enables that information to be used direct visitors in advance or help store staff work more efficiently.

3rd party applications are also available.  
<https://security.panasonic.com/i-pro-application-platform/application-list/>

## Optional Accessories

### Mount Bracket / Other

combination	WALL			POLE		CORNER	
	1	2	3	1	2	1	2
	Wall Mount Bracket <b>PWM485W</b> (White) 	Wall Mount Bracket <b>WV-QWL500-W</b> (White) 	Sun Shade <b>WV-QSR500-W</b> (White) 	Pole Mount Bracket <b>PAPM4W</b> (White) 		Corner Mount Bracket <b>PACA4W</b> (White) 	
	Conduit Adapter <b>PAPM6</b> (Black)  *If needed.	Adapter Box <b>WV-QJB500-W</b> (White)  *If needed.	Base Bracket <b>WV-QJB501-W</b> (White) 	Wall Mount Bracket <b>PWM485W</b> (White) 	Wall Mount Bracket <b>WV-QWL500-W</b> (White) (+ <b>WV-QJB500-W</b> ) 	Wall Mount Bracket <b>PWM485W</b> (White) 	Wall Mount Bracket <b>WV-QWL500-W</b> (White) (+ <b>WV-QJB500-W</b> ) 

combination	HANGING			PARAPET	CEILING		
	1	2	3	1	1	2	3
	Ceiling Mount Bracket <b>WV-QCL501-W</b> (White) 	Ceiling Mount Bracket <b>WV-QCL101-W</b> (White)  *For indoor installation only.	Ceiling Mount Bracket <b>WV-QCL101-W</b> *1 (White)  *For indoor installation only.	Parapet Mount Bracket <b>PPRM35W</b> (White) 	Ceiling Mount Bracket (Embedded) <b>WV-QEM500-W</b> (White) 	Base Bracket <b>WV-QJB501-W</b> (White) 	Ceiling Mount Bracket <b>WV-Q105A</b>  *For indoor installation only.
	Mount Bracket <b>WV-QSR501-W</b> (White) 	Mount Bracket <b>PS485W</b> (White) 	This bracket requires 1 1/2" NPT pipe. 	Mount Bracket <b>PS485W</b> (White) 			

\*1 : It's possible to be used on the camera side and ceiling side. If used on both side, 2pieces are required.

### Dome Cover

Dome Cover (Smoke type) <b>WV-CW7S</b> 	Dome Cover (Smoke type with ClearSight coating) <b>WV-CW7SN</b> 	Dome Cover (Clear type with ClearSight coating) <b>WV-CW7CN</b> 
---	--	--

### Cable

RJ45 Ethernet Cable <b>WV-QCA500A</b> <b>WV-QCA500APK</b> 	I/O Cable <b>WV-QCA501A</b> <b>WV-QCA501APK</b> 
--	---

\*WV-QCA500APK and WV-QCA501APK are package of 10 cables.

#### Trademarks and registered trademarks

- iPad and iPhone are trademarks of Apple Inc., registered in the U.S. and other countries.
- Android is a trademark of Google LLC.
- All other trademarks identified herein are the property of their respective owners.

#### Important

- Safety Precautions : Carefully read the Basic Information, Installation Guide and Operating Instructions before using this product.
- Panasonic i-PRO Sensing Solutions Co., Ltd. cannot be held responsible for the performance of the network and/or other manufacturers' products used on the network.
- Masses and dimensions are approximate. • Specifications are subject to change without notice.

# Panasonic®

Panasonic Corporation

Panasonic i-PRO Sensing Solutions Co., Ltd.

<https://ipro.panasonic.com>

<https://security.panasonic.com>

<https://www.linkedin.com/company/i-pro-sensing-solutions-co-ltd/>