

2MP (1080p) PTZ Network Camera

The WV-S6530N captures the highest quality images automatically even in very challenging and fast-changing surveillance environments. Intelligent Auto (iA) monitors scene dynamics and motion to adjust key camera settings automatically in real-time reducing distortion such as motion blur on moving objects. New industry-leading 144dB dynamic range delivers balanced scene exposure in dynamic and extreme-backlit lighting environments. In addition, color night vision provides outstanding low-light performance with accurate color rendition and saturation from i-Pro's 1/3" sensor, rivaling the performance of costlier 1/2" sensor cameras in the market. By adopting H.265 Smart Coding technology, intelligently reduces bandwidth efficiency of up to 95%* over H.264 for longer recording and less storage. Cameras out-of-the-box, use an encryption module standardized by FIPS Publication 140-2 for secure video streaming. *Value in Advanced mode. It depends on the scene.

Extreme image quality for evidence capturing under challenging conditions

- Sharp and clear image of fast moving vehicles with Intelligent Auto and ClearSight Coating
- Outstanding low light performance in true color with low noise for night time applications
- Super Dynamic 144dB for backlit situation by headlights and shadows on the streets at night
- Environmental durability: IP66, IK10, Long life Pan/Tilt gear mechanism, Wide operating temperature up to 60 °C (140 °F) and Dehumidification device

Extreme bandwidth compression with new H.265 Smart Coding

- Longer recording, less storage compared to H.264 based compression techniques
- New self-learning ROI* encoding (Auto VIQS) dynamically detect motion areas to keep vehicles and human in good picture quality while lowering your bandwidth *Region of Interest

Extreme Data Security

- Full encryption SD card edge recording to keep your data safe
- FIPS140-2 CAVP compliant *Using encryption module standardized by FIPS publication 140-2
- Full end-to-end system encryption with supported VMS and devices to protect from IP snooping/spoofing and detect data alteration

Key Features

- 2MP (1080p) 1920x1080 up to 60fps
- ClearSight Coating
- Durable Pan/Tilt gear mechanism
- iA (intelligent Auto)
- Extreme Super Dynamic 144dB
- Color night vision (0.001 to 0.015 lx)
- IP66, IK10 certified
- Wider operating temperature range
-40°C to +60°C (-40°F to +140°F)
*When using 24 V AC power supply
- i-VMD License Bundled
- ONVIF® Profile G / S / T
*ONVIF is a trademark of ONVIF, Inc.

Industry examples

- Safe Cities
- Parking lot
- Logistics
- Building



Specifications

Camera	Image Sensor	Approx. 1/2.9 Type MOS image sensor	
	Minimum Illumination	Color : 0.015 lx, BW : 0.006 lx (F1.6, Maximum shutter : Off (1/30s), AGC : 11) Color : 0.001 lx, BW : 0.0004 lx (F1.6, Maximum shutter : max. 16/30s, AGC : 11) *1	
	Intelligent Auto	On / Off	
	Shutter Speed	1/30 Fix to 1/10000 Fix *1/30 Fix to 2/120 Fix is available during 30 fps mode only. *1/60 Fix is available during 60 fps mode only.	
	Super Dynamic ²	On / Off. The level can be set in the range of 0 to 31.	
	Dynamic Range	Max.144 dB (Super Dynamic : On)	
	Image Settings	Gain (AGC), White balance	
	Image Compensation	Adaptive black stretch, Back light compensation (BLC), Fog compensation, High light compensation (HLC), Digital noise reduction	
	Color/BW (ICR)	Off / On / Auto1 (Normal) / Auto2 (IR Light) / Auto3 (SCC)	
	Video Motion Detection(VMD)	On / Off, 4 areas available	
	Intelligent VMD (i-VMD) ³	Type 4 *Bundled License	
	Stabilizer ³	On / Off (available only in the 30 fps mode)	
	Privacy Zone	Filling / Pixelate / Off (up to 32 zones available)	
	Camera Title (OSD)	On / Off, Up to 20 characters (alphanumeric characters, marks)	
	Lens	Zoom Ratio	21x Optical 31x HD Extra Optical Zoom (when resolution is 1280x720)
Digital (electronic) zoom		16x	
Focal length		4.0 mm – 84.6 mm (5/32 inches – 3-11/32 inches)	
Maximum Aperture Ratio		1 : 1.6 (WIDE) – 1 : 4.5 (TELE)	
Focus range		1.5 m (4ft 11-1/16 inches) – ∞	
Angular Field of view		[16 : 9 mode] Horizontal : 3.4 ° (TELE) – 73 ° (WIDE) Vertical : 2.0 ° (TELE) – 42 ° (WIDE) [4 : 3 mode] Horizontal : 2.9 ° (TELE) – 61 ° (WIDE) Vertical : 2.2 ° (TELE) – 46 ° (WIDE)	
Pan/tilt		Panning Range	0° – 350°
		Panning Speed	Manual : Approx. 0.5 °/s – 100 °/s Preset : Up to approx. 300°/s
		Tilting Range	Operational range : -30 ° – 90 ° (level – downward) Recommended range ⁴ : 0 ° – 90 ° Selectable tilting angle : 10 °/5 °/3 °/0 °*/-3 °*/-5 °*/-10 °*/-15 °*/-20 °*/-25 °*/-30 °*
		Tilting Speed	Manual : Approx. 0.5 °/s – 100 °/s Preset : Up to approx. 100°/s
	Preset Positions	256 positions	
Browser GUI	Auto Mode	Auto track ⁵ / Auto pan/ Preset sequence/ Patrol	
	Self Return	10 s/ 20 s/ 30 s/ 1 min/ 2 min/ 3 min/ 5 min/ 10 min/ 20 min/ 30 min/ 60 min	
	Camera Control	Pan/Tilt, Zoom, Focus, Auto mode, Brightness, Preset, AUX, Rec. on SD, Log, Viewer software	
Audio	Mic (Line) Input : On / Off	Volume adjustment : Low / Middle / High	
	Audio Output : On / Off	Volume adjustment : Low / Middle / High	
Network	Network IF	English, Italian, French, German, Spanish, Portuguese, Russian, Chinese, Japanese	
	Resolution	10Base-T / 100Base-TX, RJ45 connector	
Network	Resolution	2 mega pixel [16 : 9] (30/60 fps) 1920x1080 / 1280x720 / 640x360 / 320x180	
	JPEG (MJPEG)	3 mega pixel [4 : 3] (30 fps) 2048x1536 / 1280x960 / 800x600 / VGA / 400x300 / QVGA *Used by super resolution techniques	
	H.265/ H.264 ⁶	Constant bit rate / VBR / Frame rate / Best effort	
	Transmission Mode	Unicast / Multicast	
Network	Transmission Type	Unicast / Multicast	
	JPEG Image Quality	10 steps	

*1 Converted value

*2 Super Dynamic function is automatically set off on 60 fps mode.

*3 Stabilizer, Auto track, Smart Facial Coding, i-VMD, can not be used at the same time.

*4 The recommended range is a guide for the range of angles at which images can be completely viewed.

If the camera is tilted to an angle higher than in this range, parts of the image may not be able to be viewed.

*5 The area hidden by the camera housing may increase when the tilt angle of the camera is horizontal or larger.

*6 Transmission for 4 streams can be individually set.

Network	Smart Coding	Smart Facial Coding³ : On(Smart Facial Coding)/ On(AUTO VIQS)/ Off *Smart Facial Coding is only available with Stream(1). GOP(Group of pictures) control : On(Advanced)/ On(Mid)/ On(Low)/ Off *On(Advanced) is only available with H.265.	
	Audio Compression	G.726 (ADPCM) : 16 kbps / 32 kbps, G.711 : 64 kbps, AAC-LC ⁷ : 64 kbps / 96 kbps / 128 kbps	
	Audio transmission mode	Off / Mic (Line) input / Audio output / Interactive (Half duplex) / Interactive (Full duplex)	
	Supported Protocol	IPv6 : TCP/IP, UDP/IP, HTTP, HTTPS, RTP, FTP, SMTP, DNS, NTP, SNMP, DHCPv6, MLD, ICMP, ARP, IEEE 802.1X, DiffServ, SRTP ⁸ , MQTT ⁸ , LLDP ⁸ IPv4 : TCP/IP, UDP/IP, HTTP, HTTPS, RTSP, RTP, RTP/RTCP, FTP, SMTP, DHCP, DNS, DDNS, NTP, SNMP, UPnP, IGMP, ICMP, ARP, IEEE 802.1X, DiffServ, SRTP ⁸ , MQTT ⁸ , LLDP ⁸	
	Maximum concurrent access number	Up to 14 users (Depends on network conditions)	
	SDXC/SDHC/SD Memory Card	H.265 / H.264 recording : Manual REC / Alarm REC (Pre/Post) / Schedule REC / Backup upon network failure JPEG recording : Manual REC / Alarm REC (Pre/Post) / Backup upon network failure Compatible SDXC/SDHC/SD memory card : Panasonic 2 GB, 4 GB*, 8 GB*, 16 GB*, 32 GB*, 64 GB**, 128 GB** 256 GB** model *SDHC card, ** SDXC card (except miniSD card and microSD card)	
	Mobile Terminal Compatibility	iPad / iPhone, Android™ terminals	
	ONVIF ⁹ Profile	G / S / T	
	Alarm	Alarm Source	3 terminals input, VMD alarm ⁹ , Command alarm, Audio detection alarm, Auto track alarm
		Alarm Actions	SDXC/SDHC/SD memory recording, E-mail notification, HTTP alarm notification, Indication on browser, FTP image transfer, TCP alarm notification output
Input/ Output	Audio Input	ø3.5 mm stereo mini jack (stereo input) Input impedance: Approx. 2 kΩ (unbalanced) (Applicable microphone: Plug-in power type) Supply voltage: 4.0 V ±0.5 V	
	Audio Output ¹⁰	ø3.5 mm stereo mini jack (stereo output) Output impedance : Approx. 600 Ω (unbalanced)	
	External I/O Terminals	ALARM IN1(Alarm input 1/ Black & white input/ Auto time adjustment input), ALARM IN2(Alarm input 2/ ALARM OUT), ALARM IN3(Alarm input 3/ AUX OUT)(x1 for each)	
General	Safety	UL (UL60950-1), c-UL (CSA C22.2 No.60950-1), CE, IEC60950-1	
	EMC	FCC (Part15 ClassA), ICES003 ClassA, EN55032 ClassB, EN55024	
	Power Source and Power Consumption	AC24 V(50 Hz/60 Hz), 2.7 A Approx. 43 W PoE+ (IEEE802.3at) DC 54 V 430 mA, Approx. 22 W(Class4 device)	
	Ambient Operating Temperature	-40 °C to +60 °C (-40 °F to +140 °F) (AC 24 V) -30 °C to +60 °C (-22 °F to +140 °F) (PoE+ device) (Power On range: -30 °C to +60 °C (-22 °F to +140 °F))	
	Ambient Operating Humidity	10 to 100 % (no condensation)	
	Dehumidification Device	Rosahl element	
	Water and Dust Resistance	IP66 (IEC60529), Type 4 (UL50), NEMA 4 compliant	
	Shock Resistance	IK10 (IEC62262)	
	Dimensions	Maximum ø229 mm x 393 (H) mm(ø9-1/32 inches x 15-15/32 inches (H))	
	Mass (approx.)	Approx. 4.8 kg (10.58 lbs) (including attachment pipe: Approx. 200g (0.44 lbs))	
Finish	Main body	Aluminum die cast, Natural silver	
	Sunshields	ABS+PC resin coating, Natural silver	
Finish	Outer fixing screws	SUS (Corrosion-resistant treatment)	
	Dome cover	Polycarbonate resin(with ClearSight coating), Clear	

*7 When recording audio on an SD memory card, only use AAC-LC (Advanced Audio Coding - Low Complexity).

*8 It may be necessary to upgrade the firmware to use these protocols

*9 Including alarms from Plug-in Software

*10 The audio output can be switched to the monitor output. Refer to the Operating Instructions on the provided CD-ROM for descriptions of how to switch the output.

Appearance

Unit : mm (inches)

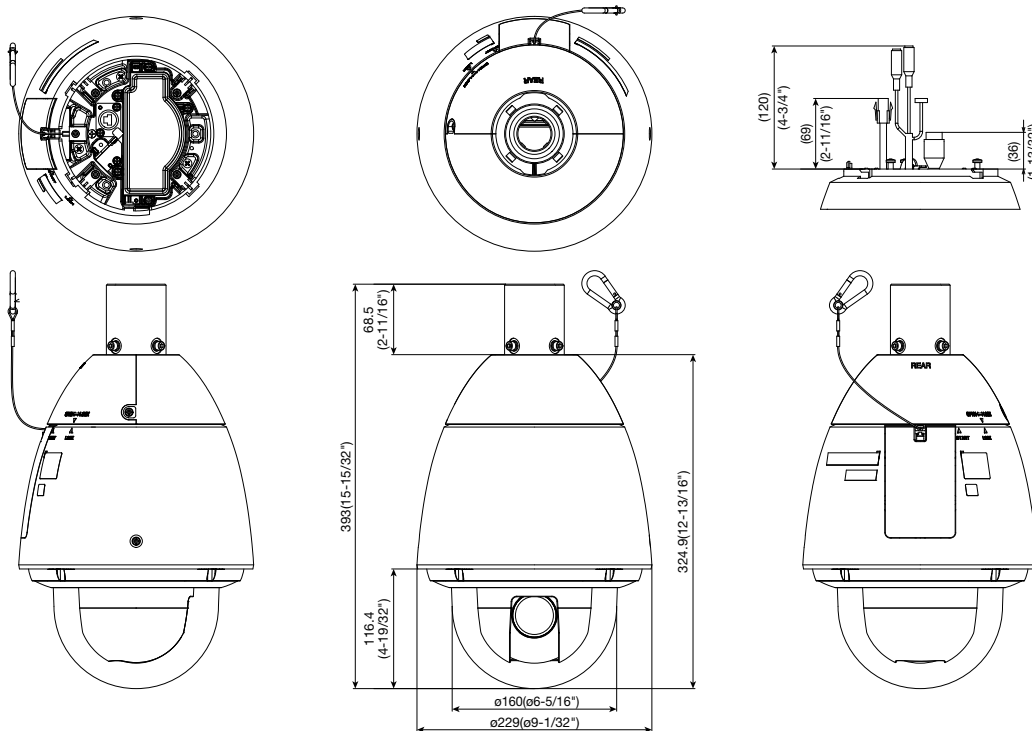

Bundled License

Plug-in Software for i-VMD



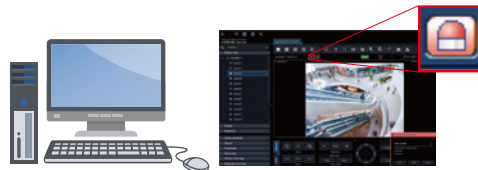



i-VMD is possible to detect objects in the specified area by advanced video analysis technology.
 i-VMD : Intruder Detection, Loitering Detection, Direction Detection, Scene Change Detection, Object Detection, Cross Line Detection



Notification sent to the monitoring screen

Optional Accessories

Mount Bracket / Other

<p>Ceiling surface mount bracket WV-QCL500-S (Silver)</p> 	<p>Ceiling Mount Bracket WV-Q121B (Fine silver)</p> 	<p>Wall Mount Bracket WV-Q122A (Fine silver)</p> 	<p>Pole Mount Bracket WV-Q188 (Fine silver)</p> <p>(This bracket requires WV-Q122A.)</p> 	<p>Corner Mount Bracket WV-Q189 (Fine silver)</p> <p>(This bracket requires WV-Q122A.)</p> 	<p>Attachment pipe (For 3rd party bracket) WV-QAT501-S (Silver)</p> 
----------------------------------------------------------------------------------------------------------------------------------------------------------------------	----------------------------------------------------------------------------------------------------------------------------------------------------------------	-------------------------------------------------------------------------------------------------------------------------------------------------------------	------------------------------------------------------------------------------------------------------------------------------------------------------------------------------------------------------	---------------------------------------------------------------------------------------------------------------------------------------------------------------------------------------------------------	-----------------------------------------------------------------------------------------------------------------------------------------------------------------------------------------------

• Brackets are available in four colors, Fine silver, Light gray, Gray and i-PRO white. It is possible to use them in different color combinations.

Important

- Safety Precautions : Carefully read the Basic Information, Installation Guide and Operating Instructions before using this product.
- i-PRO Co., Ltd. cannot be held responsible for the performance of the network and/or other manufacturers' products used on the network.

Trademarks and registered trademarks

- iPad and iPhone are trademarks of Apple Inc., registered in the U.S. and other countries.
- Android is a trademark of Google LLC.
- ONVIF is a trademark of ONVIF, Inc.
- All other trademarks identified herein are the property of their respective owners.

• Masses and dimensions are approximate. • Specifications are subject to change without notice.